

# CITROËN BERLINGO & PEUGEOT PARTNER



1996 to 2005 (P to 55 registration) Petrol & Diesel

## Owners Workshop Manual

step-by-step maintenance and repair



*The best selling car manuals in the world*

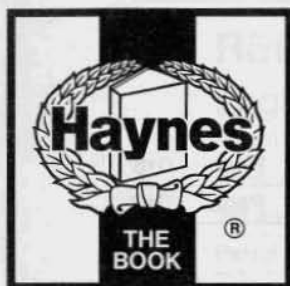

# Citroën Berlingo & Peugeot Partner Owners Workshop Manual

John S. Mead

## Models covered

(4281 - 368)

Citroën Berlingo Multispace & Van and Peugeot Partner Combi & Van, including special/limited editions

Petrol engines: 1.4 litre (1360cc) & 1.6 litre (1587cc)

Diesel engines: 1.8 litre (1769cc), 1.9 litre (1868cc & 1905cc) & 2.0 litre (1997cc), inc. turbo

*Does NOT cover models with 1.8 litre (1761cc) petrol engines*

© Haynes Publishing 2006

A book in the **Haynes Service and Repair Manual Series**

All rights reserved. No part of this book may be reproduced or transmitted in any form or by any means, electronic or mechanical, including photocopying, recording or by any information storage or retrieval system, without permission in writing from the copyright holder.

ISBN 1 84425 281 7

**British Library Cataloguing in Publication Data**

A catalogue record for this book is available from the British Library.

ABCDE  
FGHIJ  
KLMNO  
PQRST

Printed in the USA

**Haynes Publishing**  
Sparkford, Yeovil, Somerset BA22 7JJ, England

**Haynes North America, Inc**  
861 Lawrence Drive, Newbury Park, California 91320, USA

**Editions Haynes**  
4, Rue de l'Abreuvoir  
92415 COURBEVOIE CEDEX, France

**Haynes Publishing Nordiska AB**  
Box 1504, 751 45 UPPSALA, Sverige



# Contents

## LIVING WITH YOUR CITROËN BERLINGO & PEUGEOT PARTNER

Safety first!	Page 0•5
Introduction to the Citroën Berlingo & Peugeot Partner	Page 0•6

### Roadside repairs

If your car won't start	Page 0•7
Jump starting	Page 0•8
Wheel changing	Page 0•9
Identifying leaks	Page 0•10
Towing	Page 0•10

### Weekly checks

Introduction	Page 0•11
Underbonnet check points	Page 0•11
Engine oil level	Page 0•13
Coolant level	Page 0•14
Screen washer fluid level	Page 0•14
Power steering fluid level	Page 0•15
Brake fluid level	Page 0•16
Wiper blades	Page 0•16
Battery	Page 0•17
Electrical systems	Page 0•17
Tyre condition and pressure	Page 0•18

### Lubricants and fluids

Page 0•19

### Tyre pressures

Page 0•20

## MAINTENANCE

### Routine maintenance and servicing

<b>Citroën Berlingo &amp; Peugeot Partner petrol engine models</b>	Page 1A•1
Servicing specifications	Page 1A•2
Maintenance schedule	Page 1A•6
Maintenance procedures	Page 1A•7
<b>Citroën Berlingo &amp; Peugeot Partner diesel engine models</b>	Page 1B•1
Servicing specifications	Page 1B•2
Maintenance schedule	Page 1B•6
Maintenance procedures	Page 1B•7

#### Illegal Copying

It is the policy of Haynes Publishing to actively protect its Copyrights and Trade Marks. Legal action will be taken against anyone who unlawfully copies the cover or contents of this Manual. This includes all forms of unauthorised copying including digital, mechanical, and electronic in any form. Authorisation from Haynes Publishing will only be provided expressly and in writing. Illegal copying will also be reported to the appropriate statutory authorities.

# Contents

## REPAIRS AND OVERHAUL

### Engine and associated systems

Petrol engine in-car repair procedures	Page 2A•1
1.8 and 1.9 litre diesel engine (XUD series) in-car repair procedures	Page 2B•1
1.9 and 2.0 litre diesel engine (DW series) in-car repair procedures	Page 2C•1
Petrol engine removal and overhaul procedures	Page 2D•1
Diesel engine removal and overhaul procedures	Page 2E•1
Cooling, heating and air conditioning systems	Page 3•1
Fuel and exhaust systems – petrol models	Page 4A•1
Fuel and exhaust systems – 1.8 and 1.9 litre (XUD series) diesel models	Page 4B•1
Fuel and exhaust systems – 1.9 and 2.0 litre (DW series) diesel models	Page 4C•1
Emission control systems	Page 4D•1
Starting and charging systems	Page 5A•1
Ignition system – petrol models	Page 5B•1
Pre/post-heating system – diesel models	Page 5C•1

### Transmission

Clutch	Page 6•1
Manual transmission	Page 7•1
Driveshafts	Page 8•1

### Brakes, Suspension and Steering

Braking system	Page 9•1
Suspension and steering	Page 10•1

### Body Equipment

Bodywork and fittings	Page 11•1
Body electrical systems	Page 12•1

### Wiring diagrams

Page 12•19

## REFERENCE

Dimensions and weights	Page REF•1
Conversion factors	Page REF•2
Buying spare parts	Page REF•3
Vehicle identification	Page REF•3
Jacking and vehicle support	Page REF•3
General repair procedures	Page REF•4
Disconnecting the battery	Page REF•5
Tools and working facilities	Page REF•6
MOT test checks	Page REF•8
Fault finding	Page REF•12
Glossary of technical terms	Page REF•21

### Index

Page REF•26



## Advanced driving



Many people see the words 'advanced driving' and believe that it won't interest them or that it is a style of driving beyond their own abilities. Nothing could be further from the truth. Advanced driving is straightforward safe, sensible driving - the sort of driving we should all do every time we get behind the wheel.

An average of 10 people are killed every day on UK roads and 870 more are injured, some seriously. Lives are ruined daily, usually because somebody did something stupid. Something like 95% of all accidents are due to human error, mostly driver failure. Sometimes we make genuine mistakes - everyone does. Sometimes we have lapses of concentration. Sometimes we deliberately take risks.

For many people, the process of 'learning to drive' doesn't go much further than learning how to pass the driving test because of a common belief that good drivers are made by 'experience'.

Learning to drive by 'experience' teaches three driving skills:

- Quick reactions. (Whoops, that was close!)
- Good handling skills. (Horn, swerve, brake, horn).
- Reliance on vehicle technology. (Great stuff this ABS, stop in no distance even in the wet...)

Drivers whose skills are 'experience based' generally have a lot of near misses and the odd accident. The results can be seen every day in our courts and our hospital casualty departments.

Advanced drivers have learnt to control the risks by controlling the position and speed of their vehicle. They avoid accidents and near misses, even if the drivers around them make mistakes.

The key skills of advanced driving are **concentration**, **effective all-round observation**, **anticipation** and **planning**. When **good vehicle handling** is added to

these skills, all driving situations can be approached and negotiated in a safe, methodical way, leaving nothing to chance.

**Concentration** means applying your mind to safe driving, completely excluding anything that's not relevant. Driving is usually the most dangerous activity that most of us undertake in our daily routines. It deserves our full attention.

**Observation** means not just looking, but seeing and seeking out the information found in the driving environment.

**Anticipation** means asking yourself what is happening, what you can reasonably expect to happen and what could happen unexpectedly. (One of the commonest words used in compiling accident reports is 'suddenly'.)

**Planning** is the link between seeing something and taking the appropriate action. For many drivers, planning is the missing link.

If you want to become a safer and more skilful driver and you want to enjoy your driving more, contact the Institute of Advanced Motorists at [www.iam.org.uk](http://www.iam.org.uk), phone 0208 996 9600, or write to IAM House, 510 Chiswick High Road, London W4 5RG for an information pack.

Working on your car can be dangerous. This page shows just some of the potential risks and hazards, with the aim of creating a safety-conscious attitude.

## General hazards

### Scalding

- Don't remove the radiator or expansion tank cap while the engine is hot.
- Engine oil, automatic transmission fluid or power steering fluid may also be dangerously hot if the engine has recently been running.

### Burning

- Beware of burns from the exhaust system and from any part of the engine. Brake discs and drums can also be extremely hot immediately after use.

### Crushing

- When working under or near a raised vehicle, always supplement the jack with axle stands, or use drive-on ramps. **Never venture under a car which is only supported by a jack.**



- Take care if loosening or tightening high-torque nuts when the vehicle is on stands. Initial loosening and final tightening should be done with the wheels on the ground.

### Fire

- Fuel is highly flammable; fuel vapour is explosive.
- Don't let fuel spill onto a hot engine.
- Do not smoke or allow naked lights (including pilot lights) anywhere near a vehicle being worked on. Also beware of creating sparks (electrically or by use of tools).
- Fuel vapour is heavier than air, so don't work on the fuel system with the vehicle over an inspection pit.
- Another cause of fire is an electrical overload or short-circuit. Take care when repairing or modifying the vehicle wiring.
- Keep a fire extinguisher handy, of a type suitable for use on fuel and electrical fires.

### Electric shock

- Ignition HT voltage can be dangerous, especially to people with heart problems or a pacemaker. Don't work on or near the ignition system with the engine running or the ignition switched on.



- Mains voltage is also dangerous. Make sure that any mains-operated equipment is correctly earthed. Mains power points should be protected by a residual current device (RCD) circuit breaker.

### Fume or gas intoxication

- Exhaust fumes are poisonous; they often contain carbon monoxide, which is rapidly fatal if inhaled. Never run the engine in a confined space such as a garage with the doors shut.
- Fuel vapour is also poisonous, as are the vapours from some cleaning solvents and paint thinners.



### Poisonous or irritant substances

- Avoid skin contact with battery acid and with any fuel, fluid or lubricant, especially antifreeze, brake hydraulic fluid and Diesel fuel. Don't syphon them by mouth. If such a substance is swallowed or gets into the eyes, seek medical advice.
- Prolonged contact with used engine oil can cause skin cancer. Wear gloves or use a barrier cream if necessary. Change out of oil-soaked clothes and do not keep oily rags in your pocket.
- Air conditioning refrigerant forms a poisonous gas if exposed to a naked flame (including a cigarette). It can also cause skin burns on contact.

### Asbestos

- Asbestos dust can cause cancer if inhaled or swallowed. Asbestos may be found in gaskets and in brake and clutch linings. When dealing with such components it is safest to assume that they contain asbestos.

## Special hazards

### Hydrofluoric acid

- This extremely corrosive acid is formed when certain types of synthetic rubber, found in some O-rings, oil seals, fuel hoses etc, are exposed to temperatures above 400°C. The rubber changes into a charred or sticky substance containing the acid. *Once formed, the acid remains dangerous for years. If it gets onto the skin, it may be necessary to amputate the limb concerned.*
- When dealing with a vehicle which has suffered a fire, or with components salvaged from such a vehicle, wear protective gloves and discard them after use.

### The battery

- Batteries contain sulphuric acid, which attacks clothing, eyes and skin. Take care when topping-up or carrying the battery.
- The hydrogen gas given off by the battery is highly explosive. Never cause a spark or allow a naked light nearby. Be careful when connecting and disconnecting battery chargers or jump leads.

### Air bags

- Air bags can cause injury if they go off accidentally. Take care when removing the steering wheel and/or fascia. Special storage instructions may apply.

### Diesel injection equipment

- Diesel injection pumps supply fuel at very high pressure. Take care when working on the fuel injectors and fuel pipes.



**Warning:** *Never expose the hands, face or any other part of the body to injector spray; the fuel can penetrate the skin with potentially fatal results.*

## Remember...

### DO

- Do use eye protection when using power tools, and when working under the vehicle.
- Do wear gloves or use barrier cream to protect your hands when necessary.
- Do get someone to check periodically that all is well when working alone on the vehicle.
- Do keep loose clothing and long hair well out of the way of moving mechanical parts.
- Do remove rings, wristwatch etc, before working on the vehicle – especially the electrical system.
- Do ensure that any lifting or jacking equipment has a safe working load rating adequate for the job.

### DON'T

- Don't attempt to lift a heavy component which may be beyond your capability – get assistance.
- Don't rush to finish a job, or take unverified short cuts.
- Don't use ill-fitting tools which may slip and cause injury.
- Don't leave tools or parts lying around where someone can trip over them. Mop up oil and fuel spills at once.
- Don't allow children or pets to play in or near a vehicle being worked on.





Designed as a joint venture between Citroën and Peugeot, the Berlingo and Partner were introduced into the UK in 1996 as purpose-built Vans available in 600kg or 800kg payloads. To increase the appeal of the range, the Berlingo Multispace MPV was introduced in mid-1998. The Multispace is mechanically identical to the Van version but with the addition of rear seats, side windows and additional interior trim. Initially, all models were available only in three-door format, but in mid-1999, the option of a sliding side door on the right-hand side was added. The Peugeot MPV version, known as the Partner Combi, joined the model line-up for the 2001 model year, which also saw the introduction, on all models, of a second sliding side door for the left-hand side.

In the autumn of 2002, the entire range underwent a major facelift, with significant styling changes to the front bumpers,

headlights, bonnet and front wings, together with numerous mechanical and electrical revisions.

During the production run a variety of petrol and diesels engines have been offered according to model and year of production. These include 1.4 litre (1360cc), and 1.6 litre (1587cc) petrol engines, and 1.8 litre (1769cc), 1.9 litre (1868cc & 1905cc) and 2.0 litre (1997cc) diesel and turbo-diesel engines. A 1.8 litre (1761cc) petrol engine was also available for a limited period on early models, but is not covered in this manual. The engines are all of four-cylinder single- or double-overhead camshaft design and are versions of the well-proven units which have appeared in many Citroën and Peugeot vehicles over the years. All engines are fitted with a manual transmission as standard and are mounted transversely at the front of vehicle, with the transmission mounted on the left-hand end.



The front suspension is of the fully-independent MacPherson strut type, incorporating shock absorbers, coil springs and an anti-roll bar. The rear suspension is derived from the Peugeot 405 range and is of the semi-independent type with torsion bars and trailing arms. Rack-and-pinion steering gear is used with power assistance available on most models.

A wide range of standard and optional equipment is available within the range to suit most tastes, including power steering, central locking, engine immobiliser, electric windows, electric sunroof and airbags. An anti-lock braking system and air conditioning system are also available as options, or standard equipment on certain models.

Provided that regular servicing is carried out in accordance with the manufacturer's recommendations, the vehicle should prove reliable and very economical. The engine compartment is well-designed, and most of the items requiring frequent attention are easily accessible.

## Your Owner's Manual

The aim of this manual is to help you get the best value from your vehicle. It can do so in several ways. It can help you decide what work must be done (even should you choose to get it done by a garage), provide information on routine maintenance and servicing, and give a logical course of action and diagnosis when random faults occur. However, it is hoped that you will use the manual by tackling the work yourself. On simpler jobs it may even be quicker than booking the vehicle into a garage and going there twice, to leave and collect it. Perhaps most important, a lot of money can be saved by avoiding the costs a garage must charge to cover its labour and overheads.

The manual has drawings and descriptions to show the function of the various components so that their layout can be understood. Tasks are described and photographed in a clear step-by-step sequence.

References to the 'left-hand' and 'right-hand' sides of the vehicle are always in the sense of when viewed by a person sat in the driver's seat, facing forwards.

## Acknowledgements

Thanks are due to Draper Tools Limited, who provided some of the workshop tools, and to all those people at Sparkford who helped in the production of this Manual.

**We take great pride in the accuracy of information given in this manual, but vehicle manufacturers make alterations and design changes during the production run of a particular vehicle of which they do not inform us. No liability can be accepted by the authors or publishers for loss, damage or injury caused by errors in, or omissions from, the information given.**

The following pages are intended to help in dealing with common roadside emergencies and breakdowns. You will find more detailed fault finding information at the back of the manual, and repair information in the main chapters.

## If your car won't start and the starter motor doesn't turn

- Open the bonnet and make sure that the battery terminals are clean and tight.
- Switch on the headlights and try to start the engine. If the headlights go very dim when you're trying to start, the battery is probably flat. Get out of trouble by jump starting (see next page) using a friend's car.



**A** Check the security and condition of the battery connections.



**B** On petrol engines check that the ignition HT coil wiring connector is securely connected (1.4 litre petrol model shown).

## If your car won't start even though the starter motor turns as normal

- Is there fuel in the tank?
- Is there moisture on electrical components under the bonnet? Switch off the ignition, then wipe off any obvious dampness with a dry cloth. Spray a water-repellent aerosol product (WD-40 or equivalent) on ignition and fuel system electrical connectors like those shown in the photos.



**C** Also check the security of the wiring connectors at the various engine management sensors such as the coolant temperature sensor.

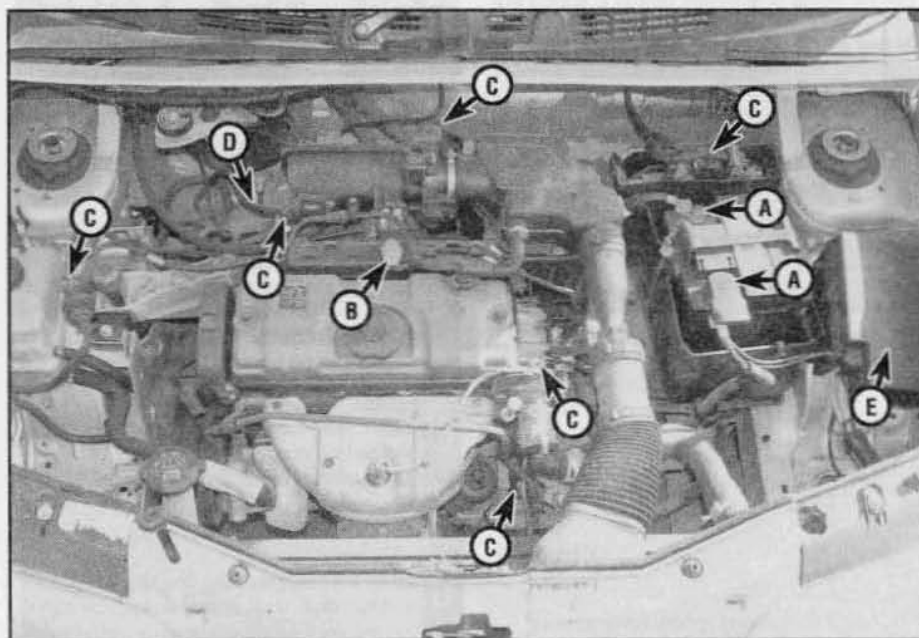

Check that all electrical connections are secure (with the ignition switched off) and spray them with a water-dispersant spray like WD-40 if you suspect a problem due to damp.

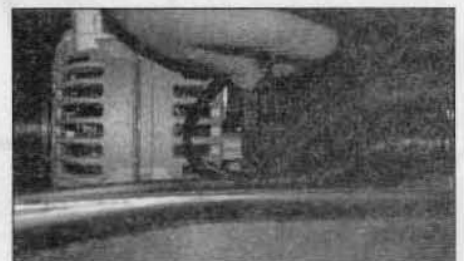

**D** Check that the alternator wiring connectors are securely connected.



**E** Check that all fuses are still in good condition and none have blown.



## Jump starting

When jump-starting a car using a booster battery, observe the following precautions:

- ✓ Before connecting the booster battery, make sure that the ignition is switched off.
- ✓ Ensure that all electrical equipment (lights, heater, wipers, etc) is switched off.
- ✓ Take note of any special precautions printed on the battery case.
- ✓ Make sure that the booster battery is the same voltage as the discharged one in the vehicle.
- ✓ If the battery is being jump-started from the battery in another vehicle, the two vehicles **MUST NOT TOUCH** each other.
- ✓ Make sure that the transmission is in neutral (or PARK, in the case of automatic transmission).

**HAYNES**  
**HiNT**

*Jump starting will get you out of trouble, but you must correct whatever made the battery go flat in the first place. There are three possibilities:*

- 1** *The battery has been drained by repeated attempts to start, or by leaving the lights on.*
- 2** *The charging system is not working properly (alternator drivebelt slack or broken, alternator wiring fault or alternator itself faulty).*
- 3** *The battery itself is at fault (electrolyte low, or battery worn out).*



**1** Connect one end of the red jump lead to the positive (+) terminal of the flat battery



**2** Connect the other end of the red lead to the positive (+) terminal of the booster battery.



**3** Connect one end of the black jump lead to the negative (-) terminal of the booster battery

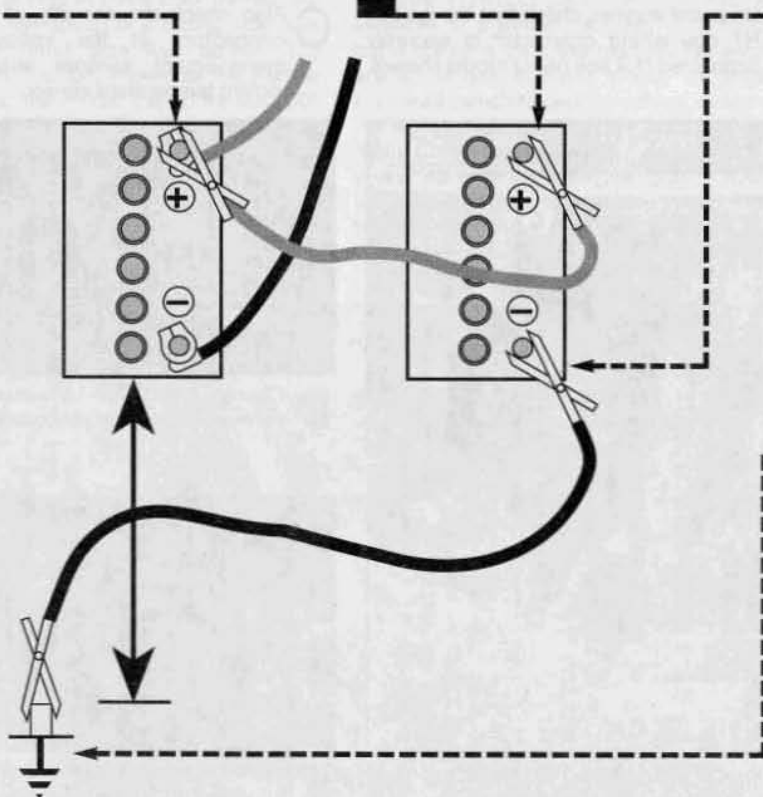

**4** Connect the other end of the black jump lead to a bolt or bracket on the engine block, well away from the battery, on the vehicle to be started.

**5** Make sure that the jump leads will not come into contact with the fan, drivebelts or other moving parts of the engine.

**6** Start the engine using the booster battery and run it at idle speed. Switch on the lights, rear window demister and heater blower motor, then disconnect the jump leads in the reverse order of connection. Turn off the lights etc.

## Wheel changing

Some of the details shown here will vary according to model. For instance, the location of the spare wheel and jack is not the same on all vehicles. However, the basic principles apply to all vehicles.



**Warning:** Do not change a wheel in a situation where you risk being hit by other traffic. On busy roads, try to stop in a lay-by or a gateway. Be wary of passing traffic while changing the wheel – it is easy to become distracted by the job in hand.

### Preparation

- When a puncture occurs, stop as soon as it is safe to do so.
- Park on firm level ground, if possible, and well out of the way of other traffic.
- Use hazard warning lights if necessary.
- If you have one, use a warning triangle to alert other drivers of your presence.
- Apply the handbrake and engage first or reverse gear.
- Chock the wheel diagonally opposite the one being removed – a chock is provided in the tool kit for this purpose.
- If the ground is soft, use a flat piece of wood to spread the load under the jack.

### Changing the wheel

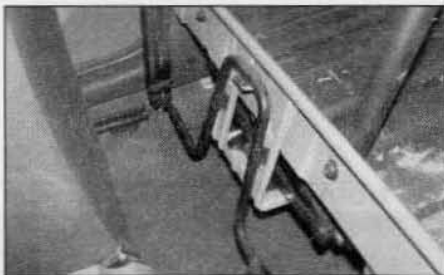

**1** The jack and wheelbrace are stored behind the driver's seat on Van models ...



**2** ... and behind a cover panel on the rear right-hand side on Multispace and Combi models.



**3** At the rear of the load area, lift up the floor covering and use the wheelbrace to lower the spare wheel cradle.



**4** Disengage the cradle from the lifting hook and slide the spare wheel out from under the vehicle. On Multispace and Combi models, remove the wheel chock from the centre of the spare wheel (on Van models, the chock is stored behind the driver's seat).

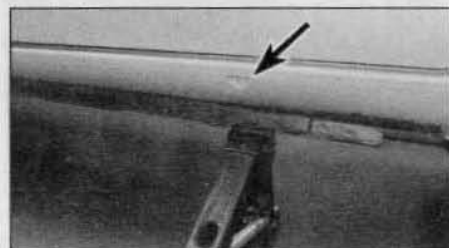

**5** Position the jack on firm ground below the reinforced area on the sill (indicated by a triangle – arrowed). Using the wheelbrace, extend the jack until the jack head correctly engages with the sill. Using the chock supplied, chock the wheel diagonally opposite the one being removed.



**6** On models with steel wheels, remove the wheel trim/hub cap (as applicable).



**7** Using the wheelbrace, slacken each wheel bolt by half a turn. On models with alloy wheels, use the special tool to undo the locking wheel nuts.



**8** Raise the jack until the wheel is clear of the ground, then unscrew the wheel bolts and remove the wheel. Place the wheel under the vehicle sill in case the jack fails. Fit the spare wheel and screw in the bolts. Lightly tighten the bolts with the wheelbrace, then lower the vehicle to the ground.

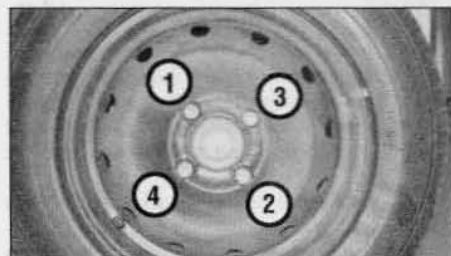

**9** Securely tighten the wheel bolts in a diagonal sequence then refit the wheel trim/hub cap (as applicable).

### Finally...

- Remove the wheel chock.
- Stow the jack and tools in the correct locations in the vehicle.
- Check the tyre pressure on the wheel just fitted. If it is low, or if you don't have a pressure gauge with you, drive slowly to the nearest garage and inflate the tyre to the right pressure.
- Have the damaged tyre or wheel repaired as soon as possible.



## Identifying leaks

Puddles on the garage floor or drive, or obvious wetness under the bonnet or underneath the car, suggest a leak that needs investigating. It can sometimes be difficult to decide where the leak is coming from, especially if the engine bay is very dirty already. Leaking oil or fluid can also be blown rearwards by the passage of air under the car, giving a false impression of where the problem lies.



**Warning:** Most automotive oils and fluids are poisonous. Wash them off skin, and change out of contaminated clothing, without delay.

**HAYNES  
HiNT**

The smell of a fluid leaking from the car may provide a clue to what's leaking. Some fluids are distinctively coloured.

It may help to clean the car carefully and to park it over some clean paper overnight as an aid to locating the source of the leak.

Remember that some leaks may only occur while the engine is running.

### Sump oil

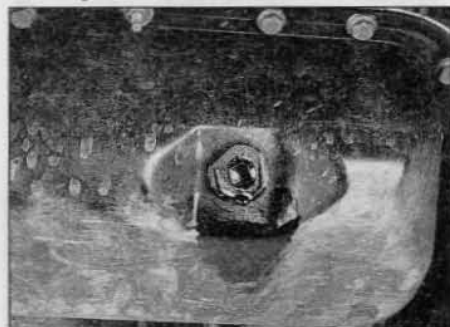

Engine oil may leak from the drain plug...

### Oil from filter

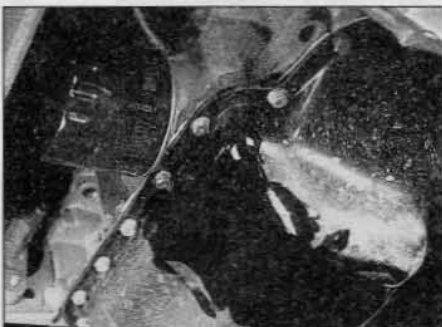

...or from the base of the oil filter.

### Gearbox oil

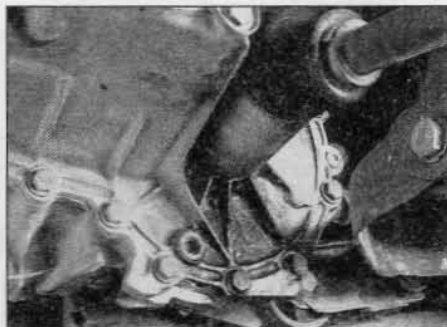

Gearbox oil can leak from the seals at the inboard ends of the driveshafts.

### Antifreeze



Leaking antifreeze often leaves a crystalline deposit like this.

### Brake fluid



A leak occurring at a wheel is almost certainly brake fluid.

### Power steering fluid

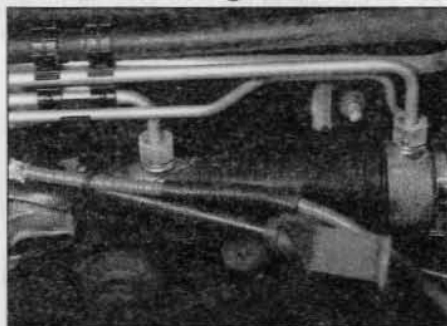

Power steering fluid may leak from the pipe connectors on the steering rack.

## Towing

When all else fails, you may find yourself having to get a tow home – or of course you may be helping somebody else. Long-distance recovery should only be done by a garage or breakdown service. For shorter distances, DIY towing using another car is easy enough, but observe the following points:

- Use a proper tow-rope – they are not expensive. The vehicle being towed must display an ON TOW sign in its rear window.
- Always turn the ignition key to the 'on'

position when the vehicle is being towed, so that the steering lock is released, and that the direction indicator and brake lights will work.

- Only attach the tow-rope to the towing eye provided at the front or rear of the vehicle.
- Before being towed, release the handbrake and select neutral on the transmission.
- Note that greater-than-usual pedal pressure will be required to operate the brakes, since the vacuum servo unit is only operational with the engine running.

- On models with power steering, greater-than-usual steering effort will also be required.
- The driver of the vehicle being towed must keep the tow-rope taut at all times to avoid snapping.
- Make sure that both drivers know the route before setting off.
- Only drive at moderate speeds and keep the distance towed to a minimum. Drive smoothly and allow plenty of time for slowing down at junctions.

## Introduction

There are some very simple checks which need only take a few minutes to carry out, but which could save you a lot of inconvenience and expense.

These *Weekly checks* require no great skill or special tools, and the small amount of time they take to perform could prove to be very well spent, for example:

□ Keeping an eye on tyre condition and pressures, will not only help to stop them wearing out prematurely, but could also save your life.

□ Many breakdowns are caused by electrical problems. Battery-related faults are particularly common, and a quick check on a regular basis will often prevent the majority of these.

□ If your vehicle develops a brake fluid leak, the first time you might know about it is when your brakes don't work properly. Checking the level regularly will give advance warning of this kind of problem.

□ If the oil or coolant levels run low, the cost of repairing any engine damage will be far greater than fixing the leak, for example.

## Underbonnet check points

### ► 1.4 litre petrol engine (pre-September 2002)

- A** Engine oil level dipstick
- B** Engine oil filler cap
- C** Coolant expansion tank
- D** Power steering fluid reservoir
- E** Brake fluid reservoir
- F** Washer fluid reservoir
- G** Battery

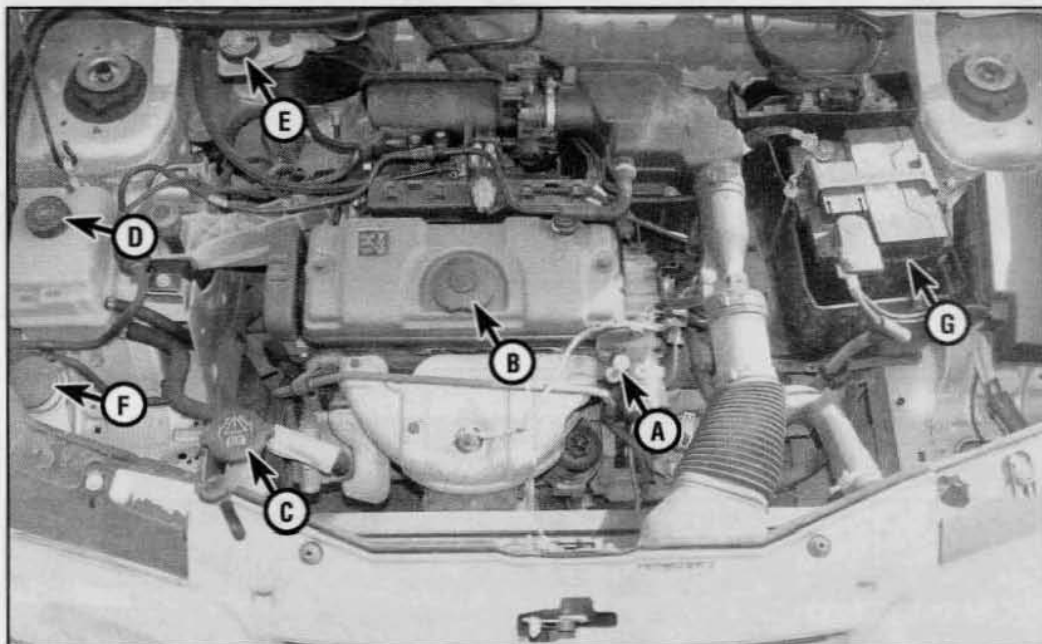

### ► 1.6 litre petrol engine

- A** Engine oil level dipstick
- B** Engine oil filler cap
- C** Coolant expansion tank
- D** Power steering fluid reservoir
- E** Brake fluid reservoir
- F** Washer fluid reservoir
- G** Battery

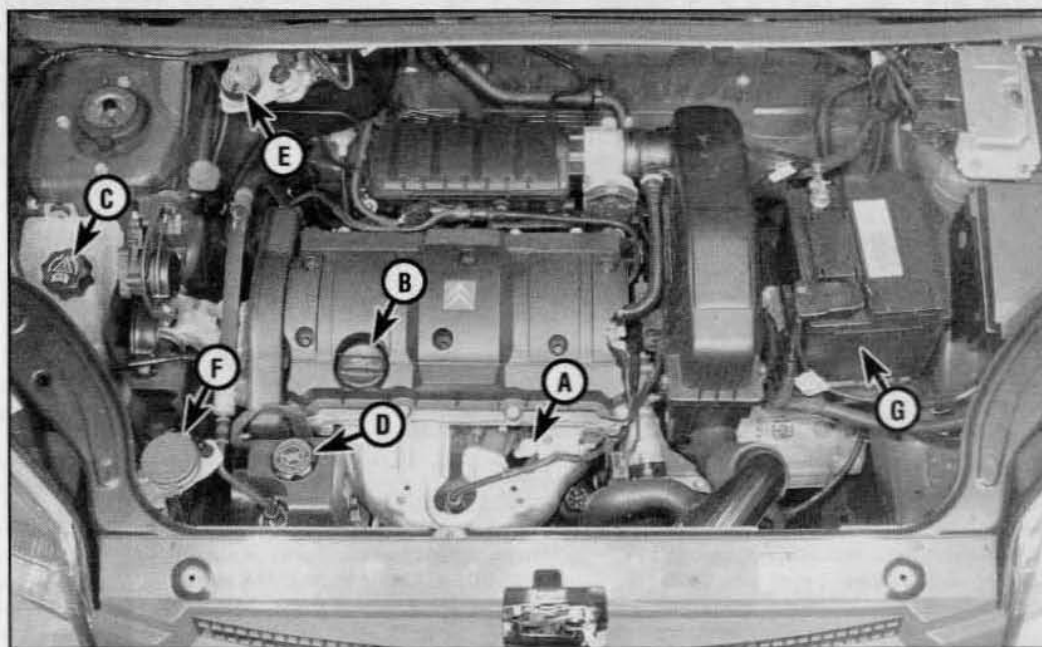

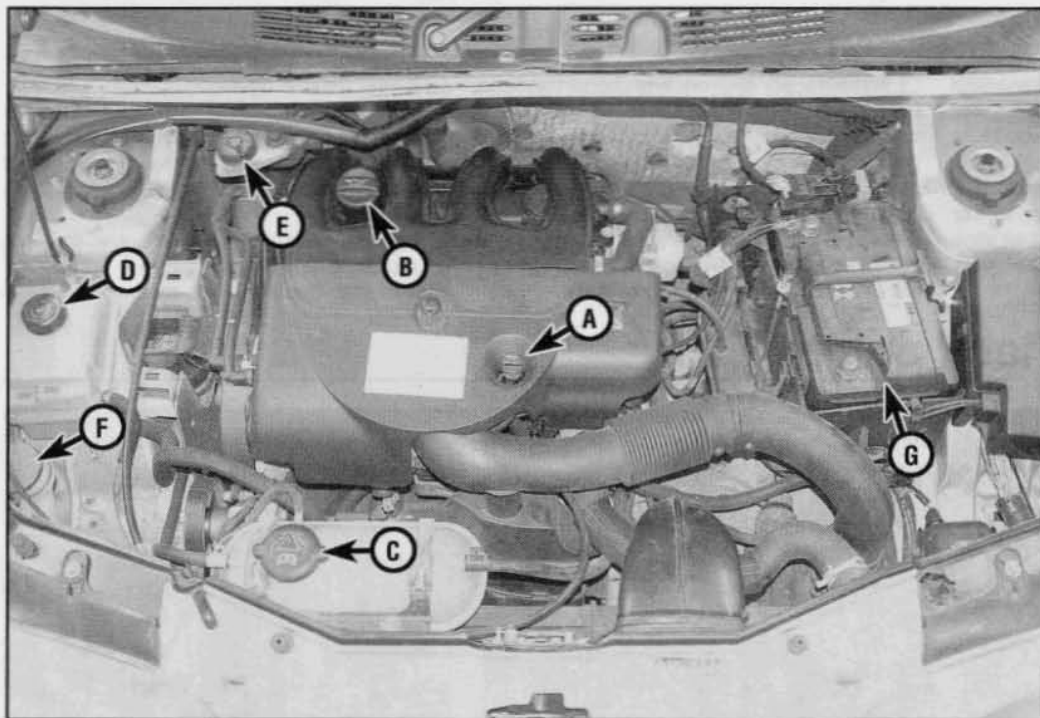

◀ **1.9 litre  
DW series  
diesel engine  
(pre-  
September  
2002) -  
XUD series  
diesel similar**

- A** Engine oil level dipstick
- B** Engine oil filler cap
- C** Coolant expansion tank
- D** Power steering fluid reservoir
- E** Brake fluid reservoir
- F** Washer fluid reservoir
- G** Battery

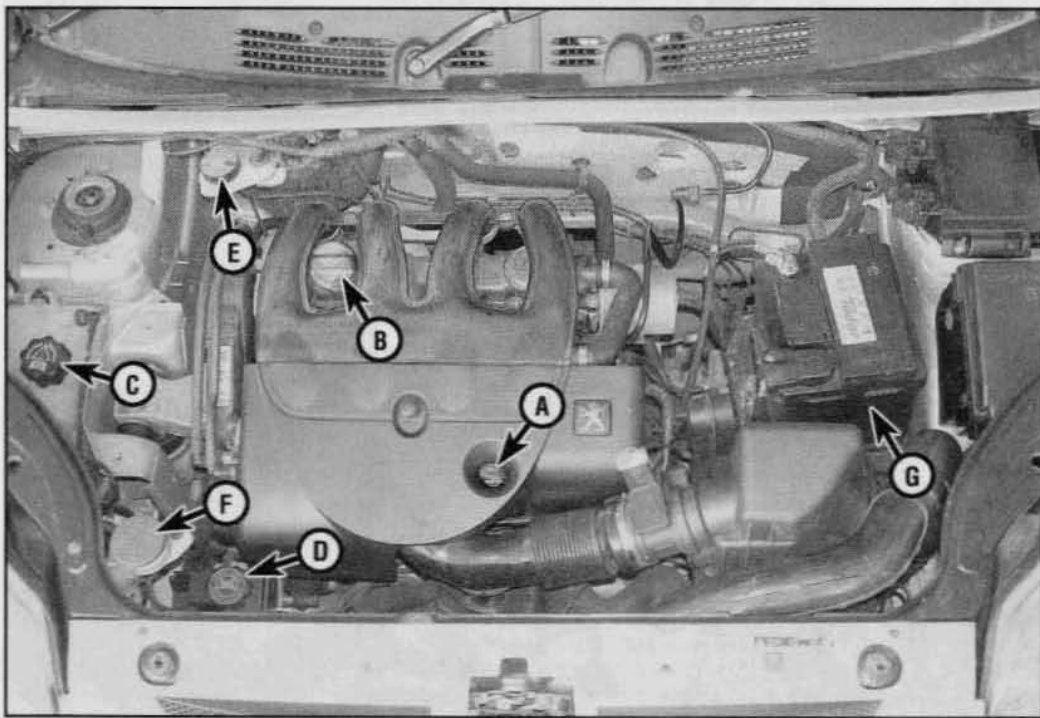

◀ **1.9 litre  
DW series  
diesel engine  
(post-  
September  
2002)**

- A** Engine oil level dipstick
- B** Engine oil filler cap
- C** Coolant expansion tank
- D** Power steering fluid reservoir
- E** Brake fluid reservoir
- F** Washer fluid reservoir
- G** Battery



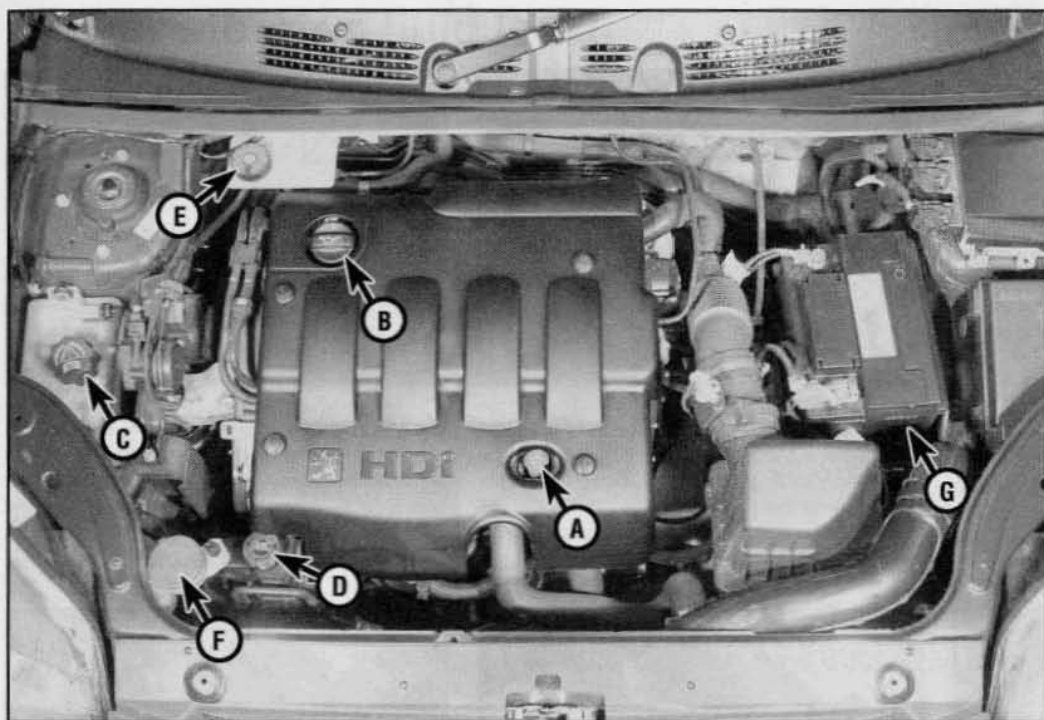

◀ **2.0 litre DW series diesel engine (post-September 2002)**

- A** Engine oil level dipstick
- B** Engine oil filler cap
- C** Coolant expansion tank
- D** Power steering fluid reservoir
- E** Brake fluid reservoir
- F** Washer fluid reservoir
- G** Battery

## Engine oil level

### Before you start

- ✓ Make sure that your vehicle is on level ground.
- ✓ Check the oil level before the vehicle is driven, or at least 5 minutes after the engine has been switched off.



*If the oil is checked immediately after driving the vehicle, some of the oil will remain in the upper engine components, resulting in an inaccurate reading on the dipstick.*

### The correct oil

Modern engines place great demands on their oil. It is very important that the correct oil for your vehicle is used (see *Lubricants and fluids*).

### Car Care

- If you have to add oil frequently, you should check whether you have any oil leaks. Place some clean paper under the vehicle overnight, and check for stains in the morning. If there are no leaks, the engine may be burning oil.
- Always maintain the level between the upper and lower dipstick marks (see photo 3). If the level is too low, severe engine damage may occur. Oil seal failure may result if the engine is overfilled by adding too much oil.

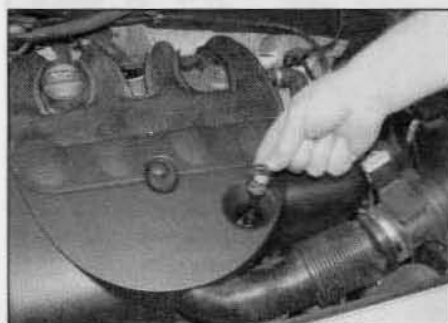

**1** The dipstick is often brightly coloured for easy identification. Withdraw the dipstick.

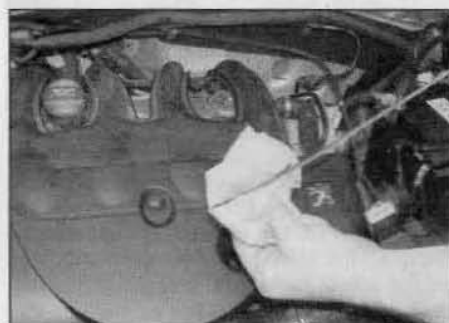

**2** Using a clean rag or paper towel, wipe all the oil from the dipstick. Insert the clean dipstick into the tube as far as it will go, then withdraw it again.

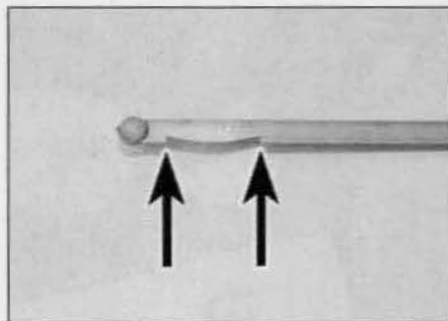

**3** Note the oil level on the end of the dipstick, which should be between the upper (MAX) mark and lower (MIN) mark.

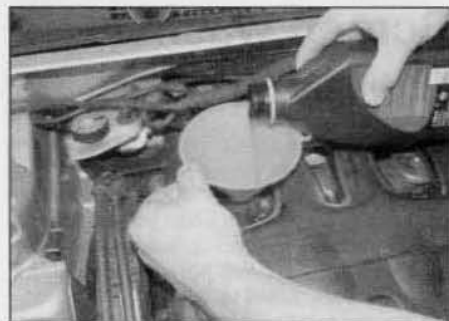

**4** Oil is added through the filler cap. Unscrew the cap and top up the level; a funnel may help to reduce spillage. Add the oil slowly, checking the level on the dipstick often. Don't overfill (see *Car Care*).

## Coolant level



**Warning:** DO NOT attempt to remove the expansion tank pressure cap when the engine is hot, as there is a very great risk of scalding. Do not leave open containers of coolant about, as it is poisonous.

### Car Care

● Adding coolant should not be necessary on a regular basis. If frequent topping-up is required, it is likely there is a leak. Check the radiator, all hoses and joint faces for signs of staining or wetness, and rectify as necessary.

● It is important that antifreeze is used in the cooling system all year round, not just during the winter months. Don't top-up with water alone, as the antifreeze will become too diluted.



**1** The coolant level varies with engine temperature. On pre-September 2002 petrol models, the level is checked in the expansion tank, which is built into the right-hand side of the radiator. When the engine is cold, the coolant level should be between the MAX and MIN marks.



**2** On pre-September 2002 diesel models, the expansion tank is located above the radiator, and the level can only be checked by removing the expansion tank cap (see step 4). When the engine is cold, the level is correct when it is just below the MAX mark indicated on the side of the tank.

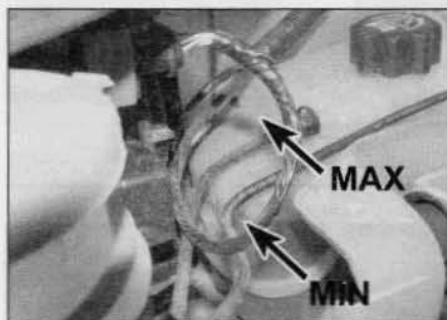

**3** On all post-September 2002 petrol and diesel models, the level is checked in the expansion tank located on the right-hand side of the engine compartment. When the engine is cold, the coolant level should be between the MAX and MIN marks indicated on the side of the tank.



**4** If topping-up is necessary, **wait until the engine is cold** then turn the expansion tank cap slowly anti-clockwise, and pause until any pressure remaining in the system is released. Unscrew the cap and lift off.

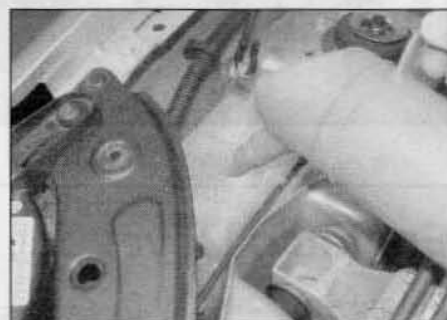

**5** Add a 50/50 mixture of water and antifreeze to the expansion tank, until the coolant level is up to the MAX level mark. Refit the cap, turning it clockwise as far as it will go until it is secure.

## Screen washer fluid level

Screenwash additives not only keep the windscreen clean during foul weather, they also prevent the washer system freezing in cold weather – which is when you are likely to need it most. Don't top-up using plain water as the screenwash will become too diluted, and will freeze during cold weather.

**On no account use coolant antifreeze in the washer system – this could discolour or damage paintwork.**



**1** The washer fluid reservoir is located at the front right-hand side of the engine compartment. To check the fluid level, open the cap and look down the filler neck.



**2** If topping-up is necessary, add water and a screenwash additive in the quantities recommended on the bottle.

## Power steering fluid level

### Before you start

- ✓ Park the vehicle on level ground.
- ✓ Set the steering wheel straight-ahead.
- ✓ The engine should be turned off.



*For the check to be accurate, the steering must not be turned once the engine has been stopped.*

### Safety First!

- The need for frequent topping-up indicates a leak, which should be investigated immediately.

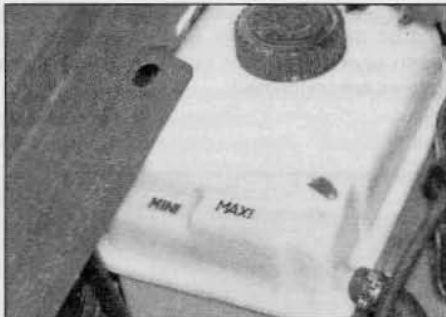

**1** On pre-September 2002 models, the power steering fluid reservoir is located on the right-hand side of the engine compartment. The fluid level should be checked with the engine stopped. A translucent reservoir is fitted, with MAX and MIN markings on the reservoir.



**2** The fluid level should be between the MAX and MIN marks. If topping-up is necessary, and before removing the cap, wipe the surrounding area so that dirt does not enter the reservoir.



**3** Unscrew the cap, allowing the fluid to drain from the bottom of the cap as it is removed. Top up the fluid level to the MAX mark, using the specified type of fluid (do not overfill the reservoir), then refit and tighten the filler cap.

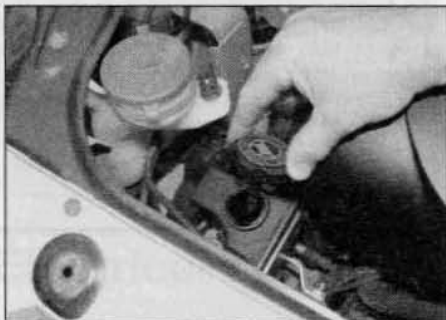

**4** On post-September 2002 models, the power steering fluid reservoir is integral with the power steering pump, located at the front of the engine. With the engine stopped, wipe clean the area around the reservoir filler neck, and unscrew the filler cap from the reservoir.

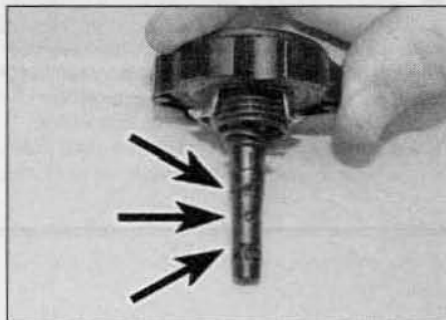

**5** Wipe all fluid from the cap dipstick with a clean rag. Refit the filler cap, then remove it again and note the fluid level on the dipstick. When the engine is cold the fluid level should be between the lower (ADD) mark and the middle (C) mark on the dipstick. If the engine is warm, the fluid level may be up to the upper (H) mark.



**6** If the fluid level is on or below the lower (ADD) mark, top-up the fluid level to the middle (C) mark, using the specified type of fluid (do not overfill). When the level is correct, securely refit the filler cap.



## Brake fluid level



**Warning:**

- Brake fluid can harm your eyes and damage painted surfaces, so use extreme caution when handling and pouring it.
- Do not use fluid that has been standing open for some time, as it absorbs moisture from the air, which can cause a dangerous loss of braking effectiveness.



- Make sure that your vehicle is on level ground.
- The fluid level in the reservoir will drop slightly as the brake pads and shoes wear down, but the fluid level must never be allowed to drop below the MIN mark.

### Safety First!

- If the reservoir requires repeated topping-up this is an indication of a fluid leak somewhere in the system, which should be investigated immediately.
- If a leak is suspected, the vehicle should not be driven until the braking system has been checked. Never take any risks where brakes are concerned.

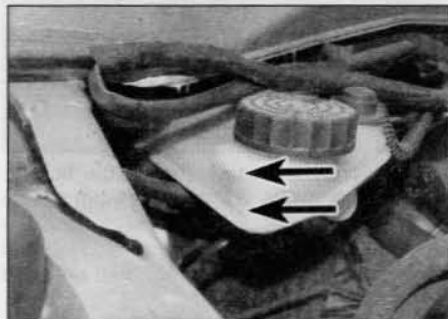

**1** The MAX and MIN marks are indicated on the side of the reservoir, which is located on the front of the vacuum servo unit in the engine compartment. The fluid level must be kept between these two marks.



**2** If topping-up is necessary, first wipe the area around the filler cap with a clean rag before removing the cap. When adding fluid, it's a good idea to inspect the reservoir. The system should be drained and refilled if dirt is seen in the fluid (see Chapter 9).

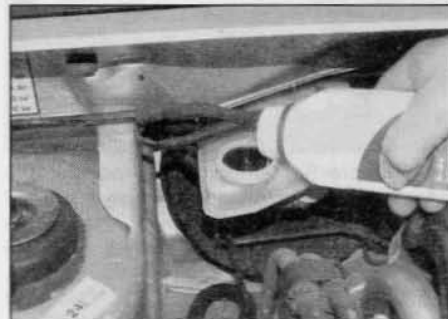

**3** Carefully add fluid, avoiding spilling it on surrounding paintwork. Use only the specified hydraulic fluid; mixing different types of fluid can cause damage to the system and/or a loss of braking effectiveness. After filling to the correct level, refit the cap securely and wipe off any spill fluid.

## Wiper blades

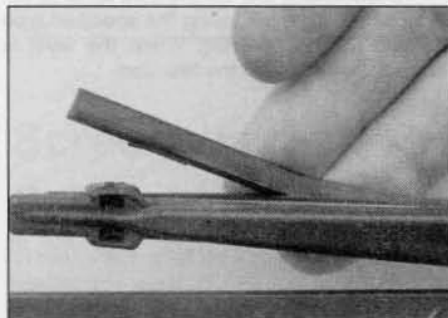

**1** Check the condition of the wiper blades; if they are cracked or show any signs of deterioration, or if the glass swept area is smeared, renew them. Wiper blades should be renewed annually.

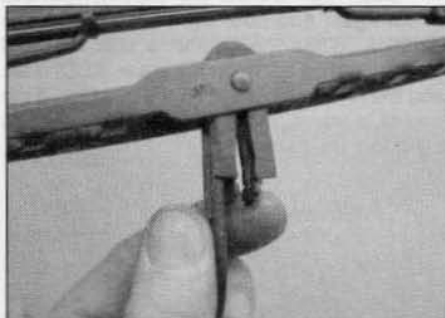

**2** To remove a windscreen wiper blade, pull the arm fully away from the screen until it locks. Swivel the blade through 90°, then depress the locking clip at the base of the mounting block.

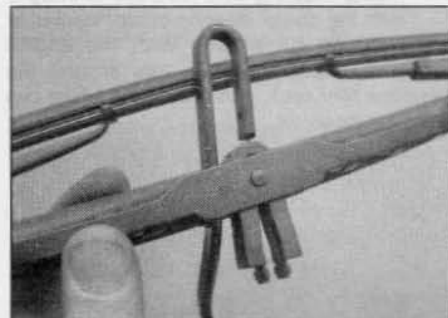

**3** Move the blade down the arm to disengage the mounting block, then slide the blade from the arm. Don't forget to check the rear wiper blade(s) as well (where applicable).

## Battery

**Caution:** Before carrying out any work on the vehicle battery, read the precautions given in 'Safety first!' at the start of this manual.

✓ Make sure that the battery tray is in good condition, and that the battery is secure. Corrosion on the tray and the battery itself can be removed with a solution of water and baking soda. Thoroughly rinse all cleaned areas with water. Any metal parts damaged by corrosion should be covered with a zinc-based primer, then painted.

✓ Periodically (approximately every three months), check the charge condition of the battery as described in Chapter 5A.

✓ If the battery is flat, and you need to jump start your vehicle, see *Roadside Repairs*.



**1** The battery is located on the left-hand side of the engine compartment. The exterior of the battery should be inspected periodically for damage such as a cracked case or cover.



**2** Check the tightness of the battery cable clamps to ensure good electrical connections. You should not be able to move them. Also check each cable for cracks and frayed conductors.



**Battery corrosion can be kept to a minimum by applying a layer of petroleum jelly to the clamps and terminals after they are reconnected.**



**3** If corrosion (white, fluffy deposits) is evident, remove the cables from the battery terminals, clean them with a small wire brush, then refit them. Automotive stores sell a useful tool for cleaning the battery post . . .

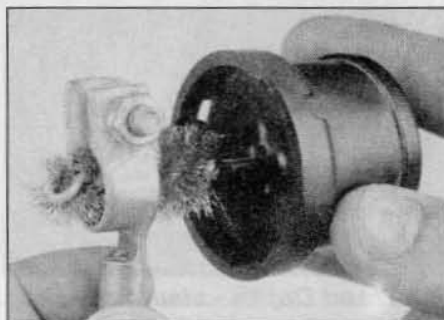

**4** . . . as well as the battery cable clamps.

## Electrical systems

✓ Check all external lights and the horn. Refer to the appropriate Sections of Chapter 12 for details if any of the circuits are found to be inoperative.

✓ Visually check all accessible wiring connectors, harnesses and retaining clips for security, and for signs of chafing or damage.

**HAYNES HiNT**

**If you need to check your brake lights and indicators unaided, back up to a wall or garage door and operate the lights. The reflected light should show if they are working properly.**

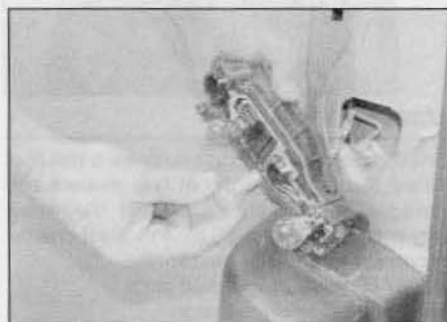

**1** If a single indicator light, brake light or headlight has failed, it is likely that a bulb has blown and will need to be renewed. Refer to Chapter 12 for details. If both brake lights have failed, it is possible that the brake/stop-light switch operated by the brake pedal has failed. Refer to Chapter 9 for details.

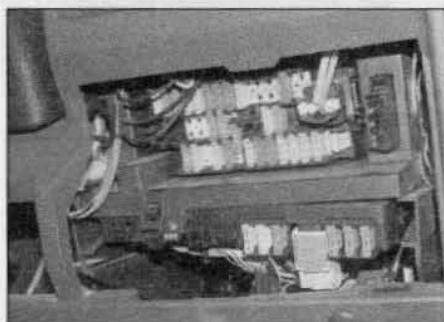

**2** If more than one indicator light or tail light has failed it is likely that either a fuse has blown or that there is a fault in the circuit (see Chapter 12). The main fuses are located behind the cover in the fascia on the driver's side . . .



**3** . . . and in the fuse/relay box in the engine compartment. To renew a blown fuse, remove it, where applicable, using the plastic tool provided. Fit a new fuse of the same rating, available from vehicle accessory shops. It is important that you find the reason that the fuse blew (see *Electrical fault finding* in Chapter 12).

## Tyre condition and pressure

It is very important that tyres are in good condition, and at the correct pressure - having a tyre failure at any speed is highly dangerous. Tyre wear is influenced by driving style - harsh braking and acceleration, or fast cornering, will all produce more rapid tyre wear. As a general rule, the front tyres wear out faster than the rears. Interchanging the tyres from front to rear ("rotating" the tyres) may result in more even wear. However, if this is completely effective, you may have the expense of replacing all four tyres at once! Remove any nails or stones embedded in the tread before they penetrate the tyre to cause deflation. If removal of a nail does reveal that

the tyre has been punctured, refit the nail so that its point of penetration is marked. Then immediately change the wheel, and have the tyre repaired by a tyre dealer.

Regularly check the tyres for damage in the form of cuts or bulges, especially in the sidewalls. Periodically remove the wheels, and clean any dirt or mud from the inside and outside surfaces. Examine the wheel rims for signs of rusting, corrosion or other damage. Light alloy wheels are easily damaged by "kerbing" whilst parking; steel wheels may also become dented or buckled. A new wheel is very often the only way to overcome severe damage.

New tyres should be balanced when they are fitted, but it may become necessary to re-balance them as they wear, or if the balance weights fitted to the wheel rim should fall off. Unbalanced tyres will wear more quickly, as will the steering and suspension components. Wheel imbalance is normally signified by vibration, particularly at a certain speed (typically around 50 mph). If this vibration is felt only through the steering, then it is likely that just the front wheels need balancing. If, however, the vibration is felt through the whole car, the rear wheels could be out of balance. Wheel balancing should be carried out by a tyre dealer or garage.

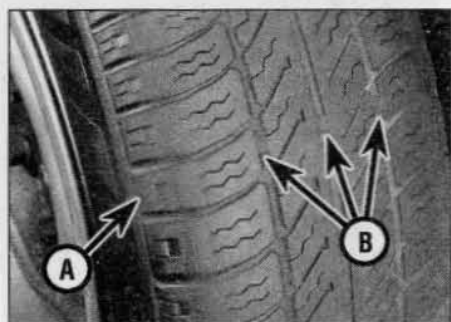

### 1 Tread Depth - visual check

The original tyres have tread wear safety bands (B), which will appear when the tread depth reaches approximately 1.6 mm. The band positions are indicated by a triangular mark on the tyre sidewall (A).

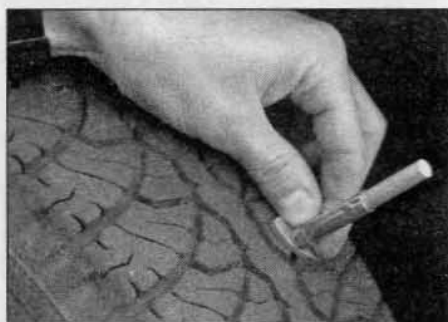

### 2 Tread Depth - manual check

Alternatively, tread wear can be monitored with a simple, inexpensive device known as a tread depth indicator gauge.

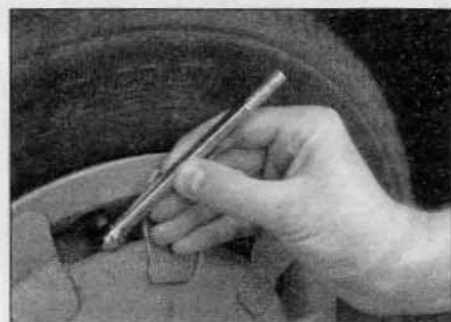

### 3 Tyre Pressure Check

Check the tyre pressures regularly with the tyres cold. Do not adjust the tyre pressures immediately after the vehicle has been used, or an inaccurate setting will result. Tyre pressures are shown on page 0•20.

## Tyre tread wear patterns



### Shoulder Wear

#### Underinflation (wear on both sides)

Under-inflation will cause overheating of the tyre, because the tyre will flex too much, and the tread will not sit correctly on the road surface. This will cause a loss of grip and excessive wear, not to mention the danger of sudden tyre failure due to heat build-up.

*Check and adjust pressures*

#### Incorrect wheel camber (wear on one side)

*Repair or renew suspension parts*

#### Hard cornering

*Reduce speed!*



### Centre Wear

#### Overinflation

Over-inflation will cause rapid wear of the centre part of the tyre tread, coupled with reduced grip, harsher ride, and the danger of shock damage occurring in the tyre casing.

*Check and adjust pressures*

*If you sometimes have to inflate your car's tyres to the higher pressures specified for maximum load or sustained high speed, don't forget to reduce the pressures to normal afterwards.*



### Uneven Wear

Front tyres may wear unevenly as a result of wheel misalignment. Most tyre dealers and garages can check and adjust the wheel alignment (or "tracking") for a modest charge.

#### Incorrect camber or castor

*Repair or renew suspension parts*

#### Malfunctioning suspension

*Repair or renew suspension parts*

#### Unbalanced wheel

*Balance tyres*

#### Incorrect toe setting

*Adjust front wheel alignment*

**Note:** *The feathered edge of the tread which typifies toe wear is best checked by feel.*



## Lubricants and fluids

### Engine:

Petrol .....	Synthetic or semi-synthetic multigrade engine oil, viscosity SAE 5W-40, 10W-40 or 5W-30* to specification API SH/SJ and/or ACEA A3: ESSO ULTRA/ULTRON or TOTAL QUARTZ
Diesel .....	Synthetic or semi-synthetic multigrade engine oil, viscosity SAE 5W-40, 10W-40 or 5W-30* to specification API CD and/or ACEA B3: ESSO ULTRA/ULTRON or TOTAL QUARTZ

**Cooling system** ..... Mixture of monoethylene glycol based antifreeze (PROCOR TM 108, GLYSANTIN G33 or REVKOGEL 2000) and clean de-ionised water

**Manual gearbox** ..... ESSO BV 75W-80W or TOTAL TRANSMISSION BV 75W-80

**Power steering fluid reservoir** ..... ESSO ATF D or TOTAL FLUIDE AT42

**Brake fluid reservoir** ..... Hydraulic fluid to SAE J1703, DOT 4

\* SAE 5W-30 engine oil may only be used in vehicles manufactured from the 2000 model year onward.

## Choosing your engine oil

Engines need oil, not only to lubricate moving parts and minimise wear, but also to maximise power output and to improve fuel economy.

### HOW ENGINE OIL WORKS

#### • **Beating friction**

Without oil, the moving surfaces inside your engine will rub together, heat up and melt, quickly causing the engine to seize. Engine oil creates a film which separates these moving parts, preventing wear and heat build-up.

#### • **Cooling hot-spots**

Temperatures inside the engine can exceed 1000° C. The engine oil circulates and acts as a coolant, transferring heat from the hot-spots to the sump.

#### • **Cleaning the engine internally**

Good quality engine oils clean the inside of your engine, collecting and dispersing combustion deposits and controlling them until they are trapped by the oil filter or flushed out at oil change.

### OIL CARE - FOLLOW THE CODE

To handle and dispose of used engine oil safely, always:



0800 66 33 66  
www.oilbankline.org.uk

- *Avoid skin contact with used engine oil. Repeated or prolonged contact can be harmful.*
- *Dispose of used oil and empty packs in a responsible manner in an authorised disposal site. Call 0800 663366 to find the one nearest to you. Never tip oil down drains or onto the ground.*

## 0.20 Tyre pressures

**Note:** On later models, the tyre pressure recommendations are marked on a label attached to the edge of the driver's door, or on the driver's door pillar. The following pressures are included as a guide, and apply to original-equipment tyres. The pressures may vary if any other make or type of tyre is fitted; check with the tyre manufacturer or supplier for correct pressures if necessary.

	Front	Rear
<b>Van models (600kg payload)</b>		
1.4 litre petrol:		
165/70 R14 89R tyres .....	2.5 bar (36 psi)	3.2 bar (46 psi)
175/65 R14 90T tyres .....	2.5 bar (36 psi)	2.9 bar (42 psi)
1.6 litre petrol:		
185/65 R15 88H tyres .....	2.2 bar (32 psi)	2.2 bar (32 psi)
1.8 and 1.9 litre diesel:		
165/70 R14 85R tyres .....	2.9 bar (42 psi)	3.2 bar (46 psi)
175/65 R14 90T tyres .....	2.5 bar (36 psi)	2.9 bar (42 psi)
2.0 litre diesel:		
175/65 R14 90T tyres .....	2.5 bar (36 psi)	2.9 bar (42 psi)
<b>Van models (800kg payload)</b>		
1.4 litre petrol:		
165/70 R14 89R tyres .....	2.5 bar (36 psi)	3.7 bar (54 psi)
175/65 R14 90T tyres .....	2.5 bar (36 psi)	3.3 bar (48 psi)
1.6 litre petrol:		
185/65 R15 88H tyres .....	2.2 bar (32 psi)	2.2 bar (32 psi)
1.8 and 1.9 litre diesel:		
165/70 R14 89R tyres .....	3.0 bar (44 psi)	3.7 bar (54 psi)
175/65 R14 90T tyres .....	2.7 bar (39 psi)	3.3 bar (48 psi)
2.0 litre diesel:		
175/65 R14 90T tyres .....	2.7 bar (39 psi)	3.3 bar (48 psi)
<b>Multispace and Combi models</b>		
1.4 litre petrol:		
175/65 R14 86T tyres:		
Normal use .....	2.6 bar (38 psi)	2.6 bar (38 psi)
Fully laden .....	2.6 bar (38 psi)	2.9 bar (42 psi)
175/70 R14 84T tyres:		
Normal use .....	2.3 bar (33 psi)	2.2 bar (32 psi)
Fully laden .....	2.3 bar (33 psi)	2.7 bar (39 psi)
1.6 litre petrol:		
185/65 R15 88H tyres:		
Normal use .....	2.2 bar (32 psi)	2.2 bar (32 psi)
Fully laden .....	2.5 bar (36 psi)	2.9 bar (42 psi)
1.8 and 1.9 litre diesel:		
175/65 R14 86T tyres:		
Normal use .....	2.6 bar (38 psi)	2.6 bar (38 psi)
Fully laden .....	2.6 bar (38 psi)	2.9 bar (42 psi)
175/70 R14 84T tyres:		
Normal use .....	2.3 bar (33 psi)	2.2 bar (32 psi)
Fully laden .....	2.5 bar (36 psi)	2.8 bar (41 psi)
2.0 litre diesel:		
175/70 R14 84T tyres:		
Normal use .....	2.3 bar (33 psi)	2.2 bar (32 psi)
Fully laden .....	2.3 bar (33 psi)	2.7 bar (39 psi)
185/65 R15 88H tyres:		
Normal use .....	2.3 bar (33 psi)	2.3 bar (33 psi)
Fully laden .....	2.3 bar (33 psi)	2.5 bar (36 psi)

# Chapter 1 Part A:

## Routine maintenance and servicing – petrol models

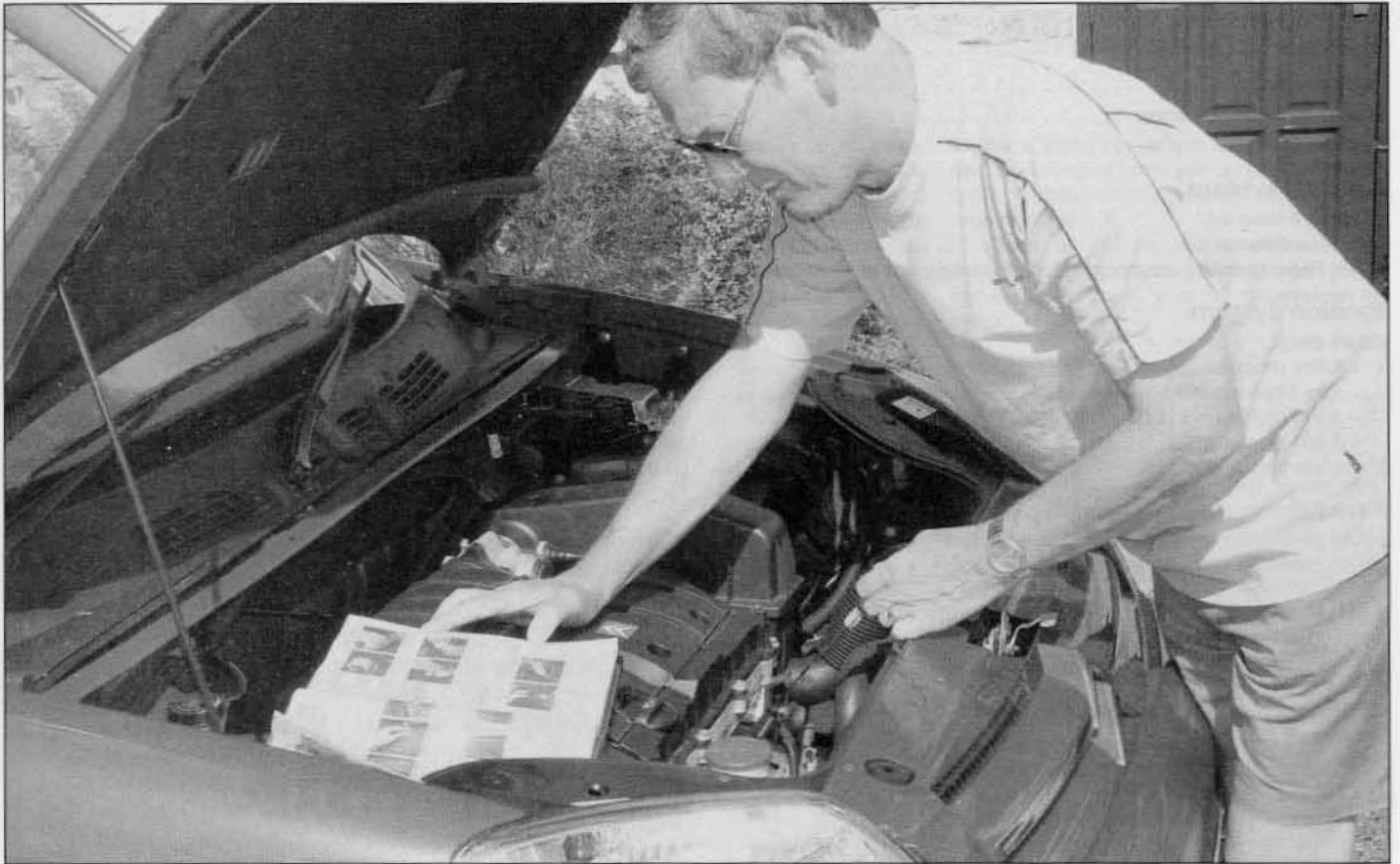

### Contents

	Section number		Section number
Airbags and seat belt pretensioners renewal .....	24	Handbrake check and adjustment .....	13
Air cleaner filter element renewal .....	19	Hinge and lock lubrication .....	6
Auxiliary drivebelt check and renewal .....	10	Hose and fluid leak check .....	4
Brake fluid renewal .....	17	Manual transmission oil level check .....	21
Coolant renewal .....	23	Pollen filter renewal .....	9
Driveshaft gaiter check .....	5	Rear brake shoe check .....	12
Emissions control systems check .....	22	Resetting the service indicator .....	8
Engine oil and filter renewal .....	3	Road test .....	7
Exhaust system check .....	14	Routine maintenance .....	2
Front brake pad check .....	11	Spark plug renewal .....	18
Fuel filter renewal .....	20	Steering and suspension check .....	15
General information .....	1	Timing belt renewal .....	16

### Degrees of difficulty

**Easy**, suitable for novice with little experience



**Fairly easy**, suitable for beginner with some experience



**Fairly difficult**, suitable for competent DIY mechanic



**Difficult**, suitable for experienced DIY mechanic



**Very difficult**, suitable for expert DIY or professional





# 1A•2 Specifications - petrol models

## Lubricants and fluids

Refer to *Weekly checks*

### Capacities (approximate)

Engine oil (including filter) .....	3.2 litres
Difference between MAX and MIN dipstick marks .....	1.5 litres

### Cooling system

Pre-September 2002 models:

Without air conditioning .....	6.5 litres
With air conditioning .....	7.0 litres
September 2002 models onward .....	8.0 litres

Transmission .....	2.0 litres
--------------------	------------

Power-assisted steering .....	1.0 litre
-------------------------------	-----------

Fuel tank .....	55.0 litres
-----------------	-------------

### Cooling system

Antifreeze mixture:

50% antifreeze .....	Protection down to -35°C
----------------------	--------------------------

**Note:** Refer to antifreeze manufacturer for latest recommendations.

### Ignition system

Spark plugs:

1.4 litre models:	
Pre-1999 models .....	Eyquem RFC52LSP or Bosch FR7LDC
1999 models onward .....	Eyquem RFN58LZ or Bosch FR7KDC
1.6 litre models .....	Bosch FR7ME
Electrode gap .....	0.9 mm

### Brakes

Brake pad friction material minimum thickness .....	2.0 mm
---	--------

Brake shoe friction material minimum thickness .....	1.5 mm
--	--------

### Tyre pressures

See end of *Weekly checks*

### Torque wrench settings

	Nm	lbf ft
Oil filter cover (later 1.4 and 1.6 litre engines) .....	25	18
Roadwheel bolts .....	90	66
Spark plugs .....	25	18
Transmission filler/level plugs .....	25	18

**Note:** This maintenance schedule is a guide recommended by Haynes, for servicing your own vehicle. For the manufacturer's maintenance schedule, check with your local dealer.

The maintenance intervals in this manual are provided with the assumption that you, not the dealer, will be carrying out the work. These are the minimum maintenance intervals

recommended by us for vehicles driven daily. If you wish to keep your vehicle in peak condition at all times, you may wish to perform some of these procedures more often. We encourage frequent maintenance, because it enhances the efficiency, performance and resale value of your vehicle. If the vehicle is driven in dusty areas, used

to tow a trailer, or driven frequently at slow speeds (idling in traffic) or on short journeys, more frequent maintenance intervals are recommended.

When the vehicle is new, it should be serviced by a factory-authorized dealer service department, in order to preserve the factory warranty.

## Every 250 miles (400 km) or weekly

- Refer to *Weekly checks*

## Every 10 000 miles (15 000 km) or 12 months – whichever comes first

- Renew the engine oil and filter (Section 3)\*.
- Check all underbonnet components or fluid leaks (Section 4).
- Check the condition of the driveshaft rubber gaiters (Section 5).
- Lubricate all hinges and locks (Section 6).
- Carry out a road test (Section 7).
- Reset the service interval indicator (Section 8).

**\*Note:** Peugeot/Citroën recommend the engine oil and filter are changed every 20 000 miles or two years. However, oil and filter changes are good for the engine and we recommend that the oil and filter are renewed at least once a year.

## Every 20 000 miles (30 000 km) or two years – whichever comes first

- Check the pollen filter (Section 9).
- Check the condition of the auxiliary drivebelt (Section 10).
- Check the condition of the front brake pads (Section 11).
- Check the condition of the rear brake shoes (Section 12).
- Check the operation of the handbrake (Section 13).
- Check the condition of the exhaust system (Section 14).
- Check the steering and suspension components (Section 15).

## Every 40 000 miles (60 000 km)

- Renew the timing belt (Section 16).

**Note:** Although the normal interval for timing belt renewal is 80 000 miles (120 000 km), it is strongly recommended that the interval is reduced to 40 000 miles (60 000 km), especially on vehicles which are subjected to intensive use, ie, mainly short journeys or a lot of stop-start driving. The actual belt renewal interval is therefore very much up to the individual owner, but bear in mind that severe engine damage will result if the belt breaks.

## Every 40 000 miles (60 000 km) or two years – whichever comes first

- Renew the brake fluid (Section 17).

## Every 40 000 miles (60 000 km) or four years – whichever comes first

- Renew the spark plugs (Section 18).
- Renew the air cleaner filter element (Section 19).
- Renew the fuel filter (Section 20).
- Check the manual transmission oil level (Section 21).
- Check the exhaust emissions (Section 22).
- Renew the coolant (Section 23).

## Every ten years

- Renew the airbags and seat belt pretensioners (Section 24).

## 1A•4 Component locations - petrol models

### Underbonnet view of a pre-September 2002 1.4 litre model

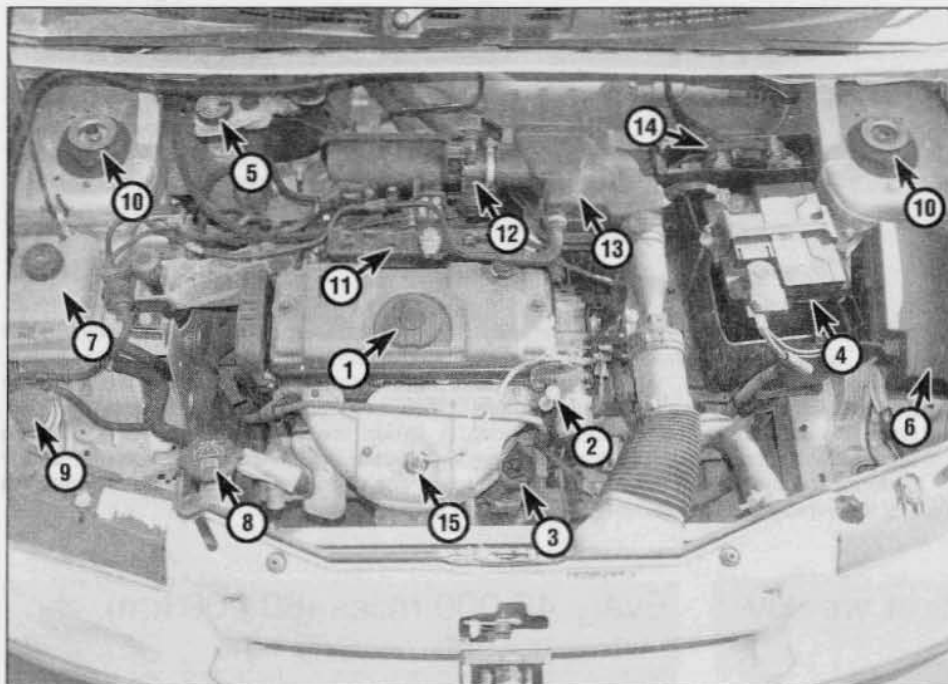

- 1 Engine oil filler cap
- 2 Engine oil dipstick
- 3 Engine oil filter
- 4 Battery
- 5 Master cylinder brake fluid reservoir
- 6 Fuse/relay box
- 7 Power steering fluid reservoir
- 8 Radiator filler cap
- 9 Windscreen/tailgate washer fluid reservoir
- 10 Suspension strut upper mounting
- 11 DIS ignition coil
- 12 Throttle housing
- 13 Air cleaner housing
- 14 Engine management system ECU
- 15 Lambda sensor

### Underbonnet view of a 1.6 litre model

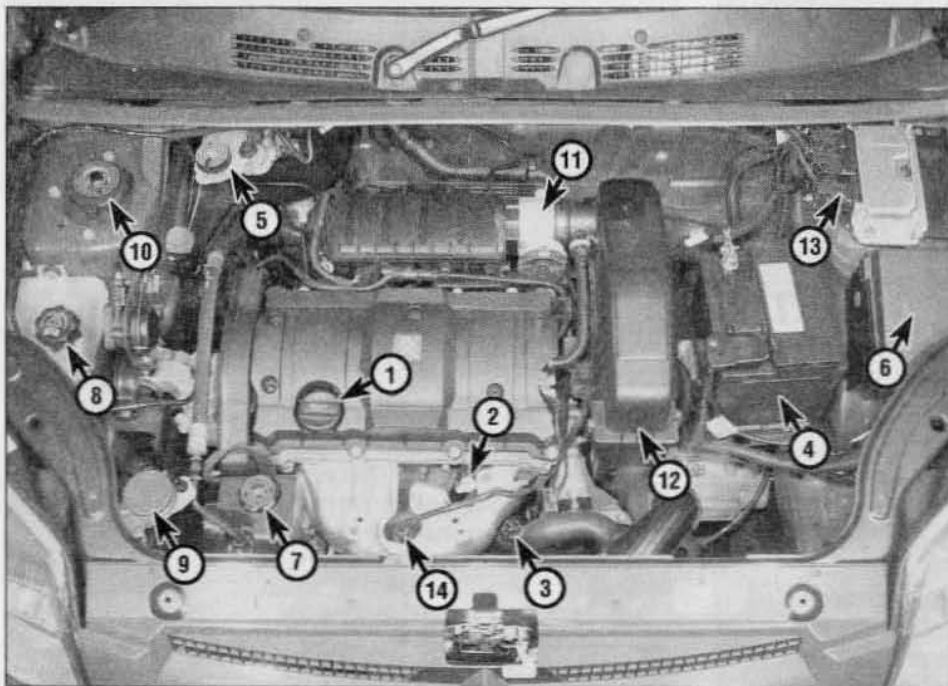

- 1 Engine oil filler cap
- 2 Engine oil dipstick
- 3 Engine oil filter
- 4 Battery
- 5 Master cylinder brake fluid reservoir
- 6 Fuse/relay box
- 7 Power steering pump fluid reservoir
- 8 Cooling system expansion tank
- 9 Windscreen/tailgate washer fluid reservoir
- 10 Suspension strut upper mounting
- 11 Throttle housing
- 12 Air cleaner housing
- 13 Engine management ECU
- 14 Lambda sensor



Front underbody view of a 1.6 litre model (1.4 litre similar)

- 1 Sump drain plug
- 2 Engine/transmission rear mounting
- 3 Exhaust front pipe/catalytic converter
- 4 Lambda sensor
- 5 Alternator
- 6 Radiator bottom hose
- 7 Clutch cable
- 8 Front suspension subframe
- 9 Front brake caliper
- 10 Front suspension lower arm
- 11 Track rod balljoint
- 12 Front anti-roll bar
- 13 Steering gear assembly

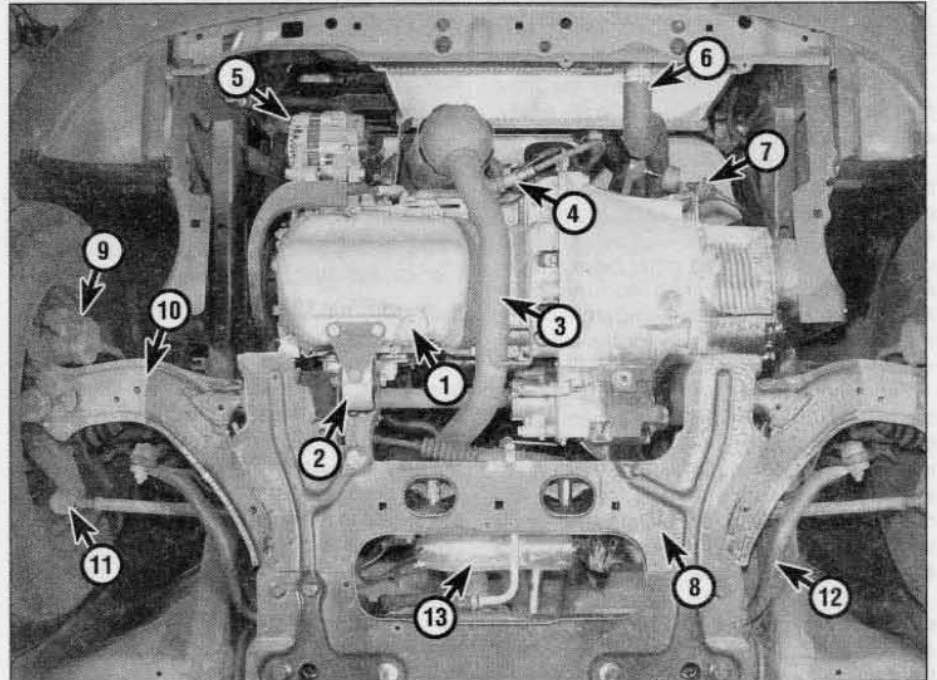

Rear underbody view

- 1 Spare wheel
- 2 Rear silencer
- 3 Fuel tank
- 4 Handbrake cable
- 5 Rear suspension torsion bar
- 6 Rear suspension tubular crossmember
- 7 Rear shock absorber
- 8 Rear suspension trailing arm

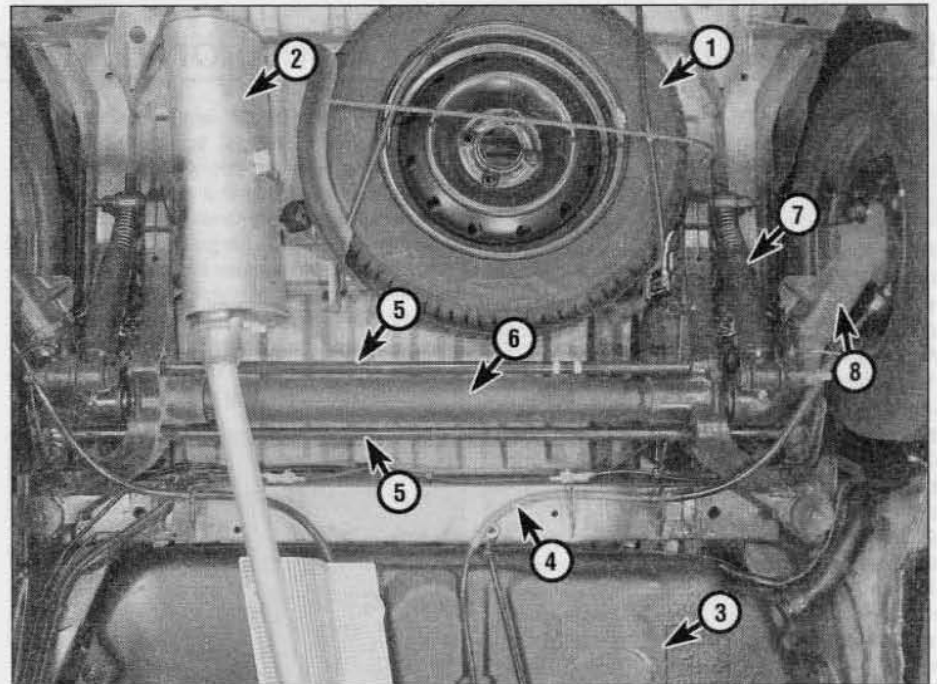

## 1 General information

This Chapter is designed to help the home mechanic maintain his/her vehicle for safety, economy, long life and peak performance.

The Chapter contains a master maintenance schedule, followed by Sections dealing specifically with each task in the schedule. Visual checks, adjustments, component renewal and other helpful items are included. Refer to the accompanying illustrations of the engine compartment and the underside of the vehicle for the locations of the various components.

Servicing your vehicle in accordance with the mileage/time maintenance schedule and the following Sections will provide a planned maintenance programme, which should result in a long and reliable service life. This is a comprehensive plan, so maintaining some items but not others at the specified service intervals, will not produce the same results.

As you service your vehicle, you will discover that many of the procedures can – and should – be grouped together, because of the particular procedure being performed, or because of the proximity of two otherwise-unrelated components to one another. For example, if the vehicle is raised for any reason, the exhaust can be inspected at the same time as the suspension and steering components.

The first step in this maintenance programme is to prepare yourself before the actual work begins. Read through all the Sections relevant to the work to be carried out, then make a list and gather all the parts and tools required. If a problem is encountered, seek advice from a parts specialist, or a dealer service department.

## 2 Routine maintenance

**1** If, from the time the vehicle is new, the routine maintenance schedule is followed closely, and frequent checks are made of fluid levels and high-wear items, as suggested throughout this manual, the engine will be kept in relatively good running condition, and the need for additional work will be minimised.

**2** It is possible that there will be times when the engine is running poorly due to the lack of regular maintenance. This is even more likely if a used vehicle, which has not received regular and frequent maintenance checks, is purchased. In such cases, additional work may need to be carried out, outside of the regular maintenance intervals.

**3** If engine wear is suspected, a compression test (refer to relevant Part of Chapter 2) will provide valuable information regarding the overall performance of the main internal components. Such a test can be used as a basis to decide on the extent of the work to

be carried out. If, for example, a test indicates serious internal engine wear, conventional maintenance as described in this Chapter will not greatly improve the performance of the engine, and may prove a waste of time and money, unless extensive overhaul work is carried out first.

**4** The following series of operations are those most often required to improve the performance of a generally poor-running engine:

### Primary operations

- Clean, inspect and test the battery (See 'Weekly checks').
- Check all the engine-related fluids (See 'Weekly checks').
- Check the condition and tension of the auxiliary drivebelt (Section 10).
- Renew the spark plugs (Section 18).
- Check the condition of the air cleaner filter element, and renew if necessary (Section 19).
- Renew the fuel filter (Section 20).
- Check the condition of all hoses, and check for fluid leaks (Section 4).

**5** If the above operations do not prove fully effective, carry out the following secondary operations:

### Secondary operations

All items listed under *Primary operations*, plus the following:

- Check the charging system (Chapter 5A).
- Check the ignition system (Chapter 5B).
- Check the fuel system (Chapter 4A).

## Every 10 000 miles (15 000 km) or 12 months

### 3 Engine oil and filter renewal

**Note:** A suitable square-section wrench may be required to undo the sump drain plug on some models. These wrenches can be obtained from most motor factors or your Peugeot/Citroën dealer.

**1** Frequent oil and filter changes are the most important preventative maintenance procedures which can be undertaken by the DIY owner. As engine oil ages, it becomes diluted and contaminated, which leads to premature engine wear.

**2** Before starting this procedure, gather together all the necessary tools and materials. Also make sure that you have plenty of clean rags and newspapers handy, to mop-up any spills. Ideally, the engine oil should be warm, as it will drain better, and more built-up sludge will be removed with it. Take care, however, not to touch the exhaust or any other hot parts of the engine when working under the vehicle. To avoid any possibility of scalding, and to protect yourself from

possible skin irritants and other harmful contaminants in used engine oils, it is advisable to wear gloves when carrying out this work. Access to the underside of the vehicle will be greatly improved if it can be raised on a lift, driven onto ramps, or jacked up and supported on axle stands (see *Jacking and vehicle support*). Whichever method is chosen, make sure that the vehicle remains level, or if it is at an angle, that the drain plug is at the lowest point.

**3** Slacken the drain plug about half a turn; on



**3.3** Slackening the sump drain plug with a square-section wrench

some models, a square-section wrench may be needed to slacken the plug (see **illustration**). Position the draining container under the drain plug, then remove the plug completely. If possible, try to keep the plug pressed into the sump while unscrewing it by hand the last couple of turns (see **Haynes Hint**). Recover the sealing washer from the drain plug.



**As the drain plug releases from the threads, move it away sharply so the stream of oil issuing from the sump runs into the container, not up your sleeve.**





3.7 Cartridge type oil filter housing location (arrowed) - later models

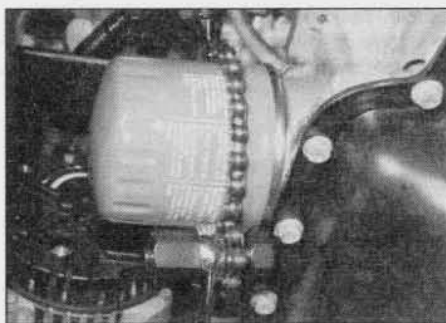

3.8 Using an oil filter removal tool to slacken the canister type oil filter

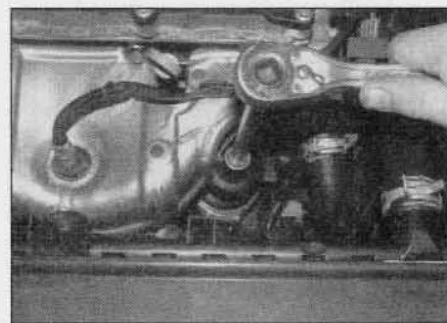

3.11a Slacken and remove the filter cover ...

4 Allow some time for the old oil to drain, noting that it may be necessary to reposition the container as the oil flow slows to a trickle.

5 After all the oil has drained, wipe off the drain plug with a clean rag, and fit a new sealing washer. Clean the area around the drain plug opening, and refit the plug. Tighten the plug securely.

6 Move the container into position under the oil filter, which is located on the front facing side of the cylinder block.

7 On early 1.4 litre models, the oil filter is of the disposable metal canister type screwed into the front of the cylinder block. However, on later 1.4 and all 1.6 litre models, the oil filter consists of a separate disposable cartridge contained in a plastic housing. The housing is located on the front of the cylinder block adjacent to the radiator hoses (see illustration). Proceed as follows according to filter type.

#### Metal canister type filter

8 Using an oil filter removal tool if necessary, slacken the filter initially, then unscrew it by hand the rest of the way (see illustration). Empty the oil in the old filter into the container. To ensure that the old filter is completely empty before disposal, puncture the filter dome in at least two places and allow any remaining oil to drain through the punctures and into the container.

9 Use a clean rag to remove all oil and dirt from the filter sealing area on the engine. Check the old filter to make sure that the rubber sealing ring hasn't stuck to the engine. If it has, carefully remove it.

10 Apply a light coating of clean engine oil to the sealing ring on the new filter, then screw it into position on the engine. Tighten the filter firmly by hand only - do not use any tools.

#### Disposable cartridge type filter

11 On these engines, the filter element is contained within a filter cover. Using a socket or spanner, slacken and remove the filter cover from above. Be prepared for fluid spillage, and recover the O-ring seal from the cover (see illustrations).

12 Pull the filter element from the filter cover.

13 Use a clean rag to remove all oil, dirt and sludge from the inside and outside of the filter cover.

14 Insert the new filter element in to the cover, then apply a little clean engine oil to the new O-ring seal, and fit it to the filter cover (see illustrations).

15 Refit the filter/cover to the housing and tighten the cover to the specified torque.

#### All engines

16 Remove the old oil and all tools from under the car. Lower the car to the ground (if applicable).

17 Remove the dipstick, then unscrew the oil filler cap from the cylinder head cover or oil filler/breather neck (as applicable). Fill the engine, using the correct grade and type of oil (see *Weekly checks*). An oil can spout or funnel may help to reduce spillage. Pour in half the specified quantity of oil first, then wait a few minutes for the oil to fall to the sump. Continue adding oil a small quantity at a time

until the level is up to the lower mark on the dipstick. Adding approximately 1.5 litres will bring the level up to the upper mark on the dipstick. Refit the filler cap.

18 Start the engine and run it for a few minutes; check for leaks around the oil filter seal and the sump drain plug. Note that there may be a delay of a few seconds before the oil pressure warning light goes out when the engine is first started, as the oil circulates through the engine oil galleries and the new oil filter before the pressure builds-up.

19 Switch off the engine, and wait a few minutes for the oil to settle in the sump once more. With the new oil circulated and the filter completely full, recheck the level on the dipstick, and add more oil as necessary.

20 Dispose of the used engine oil and filter safely, with reference to *General repair procedures* at the rear of this manual. Do not discard the old filter with domestic household waste. The facility for waste oil disposal provided by many local council refuse tips generally has a filter receptacle alongside.

#### 4 Hose and fluid leak check



#### Cooling system

**Warning:** Refer to the safety information given in 'Safety first!' and Chapter 3 before disturbing any of the cooling system components.



3.11b ... and recover the O-ring seal



3.14a Fit the new element into the cover ...



3.14b ... and apply a little clean engine oil to the O-ring seal



**HAYNES**  
**HiNT**



**A leak in the cooling system will usually show up as white- or rust-coloured deposits on the area adjoining the leak.**

**1** Carefully check the radiator and heater coolant hoses along their entire length. Renew any hose which is cracked, swollen or which shows signs of deterioration. Cracks will show up better if the hose is squeezed. Pay close attention to the clips that secure the hoses to the cooling system components. Hose clips that have been over-tightened can pinch and puncture hoses, resulting in cooling system leaks.

**2** Inspect all the cooling system components (hoses, joint faces, etc) for leaks. Where any problems of this nature are found on system components, renew the component or gasket with reference to Chapter 3.

**3** A leak from the cooling system will usually show up as white or rust-coloured deposits, on the area surrounding the leak (see Haynes Hint).

### Fuel



**Warning: Refer to the safety information given in 'Safety first!' and Chapter 4A before disturbing any of the fuel system components.**

**4** From within the engine compartment, check the security of all fuel pipe attachments and unions, and inspect the fuel pipes for kinks, chafing and deterioration.

**5** To identify fuel leaks between the fuel tank and the engine bay, the vehicle should be raised and securely supported on axle stands (see *Jacking and vehicle support*). Inspect the fuel tank and filler neck for punctures, cracks and other damage. The connection between the filler neck and tank is especially critical. Sometimes a rubber filler neck or connecting hose will leak due to loose retaining clamps or deteriorated rubber.

**6** Carefully check all rubber hoses and metal fuel lines leading away from the fuel tank. Check for loose connections, deteriorated hoses, kinked lines, and other damage. Pay particular attention to the vent pipes and hoses, which often loop up around the filler neck and can become blocked or kinked, making tank filling difficult. Follow the fuel supply and return lines to the front of the

vehicle, carefully inspecting them all the way for signs of damage or corrosion. Renew damaged sections as necessary.

### Engine oil

**7** Inspect the area around the cylinder head cover, cylinder head, oil filter and sump joint faces. Bear in mind that, over a period of time, some very slight seepage from these areas is to be expected - what you are really looking for is any indication of a serious leak caused by gasket failure. Engine oil seeping from the base of the timing belt cover or the transmission bellhousing may be an indication of crankshaft or input shaft oil seal failure. Should a leak be found, renew the failed gasket or oil seal by referring to the appropriate Chapters in this manual.

### Air conditioning refrigerant



**Warning: Refer to the safety information given in 'Safety first!' and Chapter 3, regarding the dangers of disturbing any of the air conditioning system components.**

**8** The air conditioning system is filled with a liquid refrigerant, which is retained under high pressure. If the air conditioning system is opened and depressurised without the aid of specialised equipment, the refrigerant will immediately turn into gas and escape into the atmosphere. If the liquid comes into contact with your skin, it can cause severe frostbite. In addition, the refrigerant contains substances which are environmentally damaging; for this reason, it should not be allowed to escape into the atmosphere.

**9** Any suspected air conditioning system leaks should be immediately referred to a Peugeot/Citroën dealer or air conditioning specialist. Leakage will be shown up as a steady drop in the level of refrigerant in the system.

**10** Note that water may drip from the condenser drain pipe, underneath the car, immediately after the air conditioning system has been in use. This is normal, and should not be cause for concern.

### Brake fluid



**Warning: Refer to the safety information given in 'Safety first!' and Chapter 9, regarding the dangers of handling brake fluid.**

**11** With reference to Chapter 9, examine the area surrounding the brake pipe unions at the master cylinder for signs of leakage. Check the area around the base of fluid reservoir, for signs of leakage caused by seal failure. Also examine the brake pipe unions at the ABS hydraulic modulator (where applicable).

**12** If fluid loss is evident, but the leak cannot be pinpointed in the engine bay, the front brake calipers, rear wheel cylinders and underbody brake lines and should be carefully

checked with the vehicle raised and supported on axle stands. Leakage of fluid from the braking system is serious fault that must be rectified immediately.

**13** Brake hydraulic fluid is a toxic substance with a watery consistency. New fluid is almost colourless, but it becomes darker with age and use.

### Unidentified fluid leaks

**14** If there are signs that a fluid of some description is leaking from the vehicle, but you cannot identify the type of fluid or its exact origin, park the vehicle overnight and slide a large piece of card underneath it. Providing that the card is positioned in roughly in the right location, even the smallest leak will show up on the card. Not only will this help you to pinpoint the exact location of the leak, it should be easier to identify the fluid from its colour. Bear in mind, though, that the leak may only be occurring when the engine is running!

### Vacuum hoses

**15** Although the braking system is hydraulically-operated, the brake servo unit amplifies the effort you apply at the brake pedal, by making use of the vacuum created in the inlet manifold. Vacuum is ported to the servo by means of a large-bore hose. Any leaks that develop in this hose will reduce the effectiveness of the braking system.

**16** In addition, many of the underbonnet components, particularly the emission control components, are driven by vacuum supplied from the inlet manifold via narrow-bore hoses. A leak in a vacuum hose means that air is being drawn into the hose (rather than escaping from it) and this makes leakage very difficult to detect. One method is to use an old length of vacuum hose as a kind of stethoscope - hold one end close to (but not in) your ear and use the other end to probe the area around the suspected leak. When the end of the hose is directly over a vacuum leak, a hissing sound will be heard clearly through the hose. Care must be taken to avoid contacting hot or moving components, as the engine must be running, when testing in this manner. Renew any vacuum hoses that are found to be defective.

### 5 Driveshaft gaiter check



**1** With the vehicle raised and securely supported on axle stands (see *Jacking and vehicle support*), turn the steering onto full lock, then slowly rotate the roadwheel. Inspect the condition of the outer constant velocity (CV) joint rubber gaiters, squeezing the gaiters to open out the folds (see

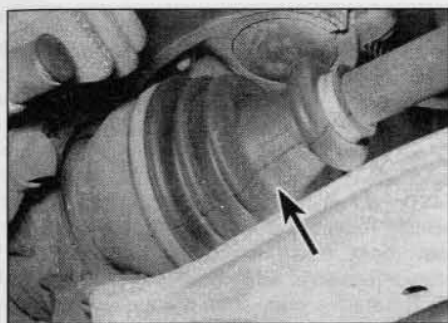

**5.1 Check the condition of the driveshaft gaiters (arrowed)**

**illustration).** Check for signs of cracking, splits or deterioration of the rubber, which may allow the grease to escape, and lead to water and grit entry into the joint. Also check the security and condition of the retaining clips. Repeat these checks on the inner CV joints. If any damage or deterioration is found, the gaiters should be renewed (see Chapter 8).

**2** At the same time, check the general condition of the CV joints themselves by first holding the driveshaft and attempting to rotate the wheel. Repeat this check by holding the inner joint and attempting to rotate the driveshaft. Any appreciable movement indicates wear in the joints, wear in the driveshaft splines, or a loose driveshaft retaining nut.

## 6 Hinge and lock lubrication

**1** Work around the vehicle and lubricate the hinges of the bonnet, doors and tailgate with a small amount of general-purpose oil.

**2** Lightly lubricate the bonnet release mechanism and exposed section of inner cable with a smear of grease.

**3** Check carefully the security and operation of all hinges, latches and locks, adjusting them where required. Check the operation of the central locking system.

**4** Check the condition and operation of the tailgate struts, renewing them if either is leaking or no longer able to support the tailgate securely when raised.

## 7 Road test

### Instruments and electrical equipment

**1** Check the operation of all instruments and electrical equipment.

**2** Make sure that all instruments read correctly, and switch on all electrical equipment in turn to check it functions properly.

### Steering and suspension

**3** Drive the vehicle, and check that there are no unusual vibrations or noises.

**4** Check for any abnormalities in the steering, suspension, handling or road 'feel'.

**5** Check that the steering feels positive, with no excessive 'sloppiness', or roughness, and check for any suspension noises when cornering, or when driving over bumps.

### Drivetrain

**6** Check the performance of the engine, clutch, transmission and driveshafts.

**7** Listen for any unusual noises from the engine, clutch and transmission.

**8** Make sure the engine idles smoothly, and that there is no hesitation when accelerating.

**9** Check that the clutch action is smooth and progressive, that the drive is taken up smoothly, and that the pedal travel is not excessive. Also listen for any noises when the clutch pedal is depressed.

**10** Check that all gears can be engaged smoothly, without noise, and that the gear lever action is smooth and not vague or 'notchy'.

**11** Listen for a metallic clicking sound from the front of the vehicle, as the vehicle is driven slowly in a circle with the steering on full lock. Carry out this check in both directions. If a

clicking noise is heard, this generally indicates lack of lubrication or wear in a driveshaft outer constant velocity joint (see Chapter 8).

### Braking system

**12** Make sure that the vehicle does not pull to one side when braking, and that the wheels do not lock when braking hard.

**13** Check that there is no vibration through the steering when braking.

**14** Check that the handbrake operates correctly, without excessive movement of the lever, and that it holds the vehicle on a slope.

**15** Test the operation of the brake servo unit as follows. With the engine off, depress the footbrake four or five times to exhaust the vacuum. Start the engine, holding the brake pedal depressed. As the engine starts, there should be a noticeable 'give' in the brake pedal as vacuum builds-up. Allow the engine to run for at least two minutes, and then switch it off. If the brake pedal is depressed now, it should be possible to detect a hiss from the servo as the pedal is depressed. After about four or five applications, no further hissing should be heard, and the pedal should feel considerably firmer.

## 8 Resetting the service indicator

**1** On completion of the service, reset the service interval indicator as follows.

**2** With the ignition switched off, press and hold the trip meter button.

**3** Turn on the ignition switch, and the display begins a countdown. When the countdown reaches 0, release the trip meter button, and the spanner service symbol in the display will disappear.

**4** Turn off the ignition switch.

**5** Turn on the ignition switch and check the correct mileage to the next service interval is displayed on the indicator.

**Note:** If you need to disconnect the battery after carrying out this procedure, lock the vehicle and wait at least 5 minutes. Otherwise the display reset may not register.

# Every 20 000 miles (30 000 km) or two years

## 9 Pollen filter renewal

**1** Release the carpet trim panel from under the fascia on the passenger's side.

**2** Remove the three securing screws, and withdraw the lid from the pollen filter housing on the heater assembly. If no screws are visible, slide the lid sideways to release the internal retaining lugs.

**3** Withdraw the pollen filter.

**4** Clean the filter housing and the lid, then fit the new filter using a reversal of the removal procedure.

## 10 Auxiliary drivebelt check and renewal

**Note:** Peugeot/Citroën specify the use of a special electronic tool (SEEM C.TRONIC type 105 belt tensioning measuring tool) to correctly set the auxiliary drivebelt tension on manually-adjusted drivebelts. This is an

involved process that varies significantly according to engine type, model year, and belt type and condition. The following procedure is an alternative method assuming that the electronic equipment is not being used. If any problems arise (such as screeching noises when driving) the tension should be checked by a dealer using the special electronic tool at the earliest opportunity.

**1** Depending on specification, either one or two auxiliary drivebelts are fitted. Where two belts are fitted, it will obviously be necessary to remove the outer belt in order to renew the inner belt.



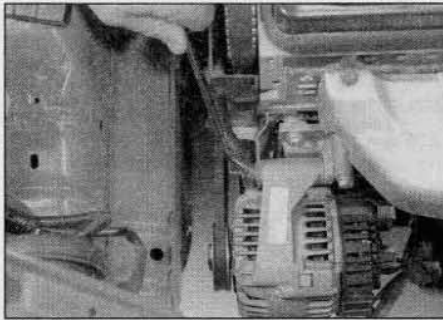

10.8a Slacken the alternator upper mounting bolt . . .

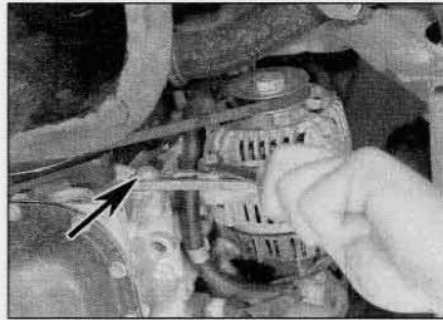

10.8b . . . the lower mounting bolt and the adjuster strap (arrowed) - models with a manual adjuster on the alternator lower mounting

**HAYNES HINT** Correct tensioning of the drivebelt will ensure it has a long life. A belt which is too slack will slip and squeal. Beware of overtightening, as this can cause wear in the alternator bearings.

**Check**

2 Chock the rear wheels then jack up the front of the vehicle and support it on axle stands (see *Jacking and vehicle support*). Remove the right-hand front roadwheel.

3 From underneath the front of the car, undo the screws, prise out the retaining clips, and remove the wheel arch liner from the wing valance to gain access to the crankshaft sprocket/pulley bolt. Where necessary, unclip the coolant hoses from the wing to improve access further.

4 Using a suitable socket and extension bar fitted to the crankshaft sprocket/pulley bolt, rotate the crankshaft so that the entire length of the drivebelt(s) can be examined. Examine the drivebelt(s) for cracks, splitting, fraying or damage. Check also for signs of glazing (shiny patches) and for separation of the belt plies. Renew the belt if worn or damaged.

5 If the condition of the belt is satisfactory, on models where the belt is adjusted manually, check the drivebelt tension as described below, bearing in mind the Note at the start of this Section. On models with an automatic spring-loaded tensioner, there is no need to check the drivebelt tension.

**Manual adjuster on alternator lower mounting**

**Removal**

6 If not already done, proceed as described in paragraphs 2 and 3.

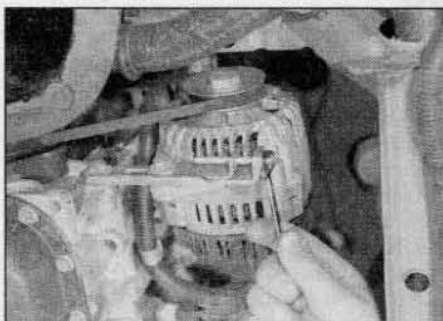

10.9a Turn the adjuster bolt to relieve the tension in the drivebelt . . .



10.9b . . . then slip the drivebelt from the pulleys - models with a manual adjuster on the alternator lower mounting

7 Disconnect the battery negative terminal (refer to *Disconnecting the battery* in the Reference Chapter).

8 Slacken the alternator upper and lower mounting bolts and, where applicable, the adjuster strap mounting bolt (see *illustrations*).

9 Turn the adjuster bolt as necessary to relieve the tension in the drivebelt, then slip the drivebelt from the pulleys (see *illustrations*). **Note:** *If the belt is going to be re-used, mark the direction of rotation on the belt prior to removal. This will ensure it is refitted the correct way around.*

**Refitting**

10 If the belt is being renewed, ensure that the correct type is used and if the original belt is being refitted, use the mark made on removal to ensure it is fitted the correct way around. Fit the belt around the pulleys, and take up the slack in the belt by means of the adjuster bolt.

11 Tension the drivebelt as described in the following paragraphs.

**Tensioning**

12 If not already done, proceed as described in paragraphs 2 and 3.

13 The belt should be tensioned so that, under firm thumb pressure, there is about 5.0 mm of free movement at the mid-point between the pulleys on the longest belt run (see the note at the start of this Section).

14 To adjust, with the mounting bolts just holding the alternator, but still allowing slight movement, turn the adjuster bolt until the correct tension is achieved.

15 Rotate the crankshaft a couple of times, recheck the tension, then tighten both the alternator mountings. Where applicable, also tighten the bolt securing the adjuster strap to its mounting bracket.

16 Reconnect the battery negative terminal.

17 Clip the coolant hoses into position (where necessary), then refit the wheel arch liner. Refit the roadwheel, and lower the vehicle to the ground.

**Manually-adjusted sliding tensioning pulley**

**Removal**

18 If not already done, proceed as described in paragraphs 2 and 3.

19 Disconnect the battery negative terminal (refer to *Disconnecting the battery* in the Reference Chapter).

20 Slacken the two bolts securing the tensioning pulley assembly to the engine (see *illustration*).

21 Rotate the adjuster bolt to move the tensioning pulley away from the drivebelt until there is sufficient slack for the drivebelt to be removed from the pulleys. **Note:** *If the belt is going to be re-used, mark the direction of rotation on the belt prior to removal. This will ensure it is refitted the correct way around.*

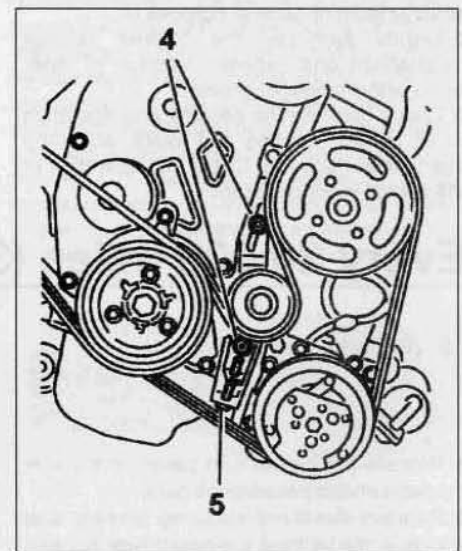

10.20 Tensioning pulley securing screws (4) and adjuster bolt (5) - models with a manually-adjusted sliding tensioning pulley



**Refitting**

22 If the belt is being renewed, ensure that the correct type is used and if the original belt is being refitted, use the mark made on removal to ensure it is fitted the correct way around. Fit the belt around the pulleys, ensuring that the ribs on the belt are correctly engaged with the grooves in the pulleys, and that the drivebelt is correctly routed. Take all the slack out of the belt by turning the tensioner pulley adjuster bolt. Tension the belt as follows.

**Tensioning**

23 If not already done, proceed as described in paragraphs 2 and 3.

24 Correct tensioning of the drivebelt will ensure that it has a long life - see Haynes Hint above.

25 The belt should be tensioned so that, under firm thumb pressure, there is approximately 5.0 mm of free movement at the mid-point between the pulleys on the longest belt run (see Note at the start of this Section).

26 To adjust the tension, with the two tensioner pulley assembly retaining bolts slackened, rotate the adjuster bolt until the correct tension is achieved. Once the belt is correctly tensioned, rotate the crankshaft a couple of times and recheck the tension.

27 When the belt is correctly tensioned, securely tighten the tensioner pulley assembly retaining bolts, then reconnect the battery negative terminal.

28 Clip the coolant hoses into position, then refit the wheel arch liner. Refit the roadwheel, and lower the vehicle to the ground.

**Manually-adjusted fixed tensioning pulley**

**Removal**

29 If not already done, proceed as described in paragraphs 2 and 3.

30 Disconnect the battery negative terminal (refer to *Disconnecting the battery* in the Reference Chapter).

31 Slacken the tensioning pulley nut and rotate the centre bolt to move the pulley away from the drivebelt until there is sufficient slack for the belt to be removed from the pulleys (see illustration). **Note:** If the belt is going to be re-used, mark the direction of rotation on the belt prior to removal. This will ensure it is refitted the correct way around.

**Refitting**

32 If the belt is being renewed, ensure that the correct type is used and if the original belt is being refitted, use the mark made on removal to ensure it is fitted the correct way around. Fit the belt around the pulleys, ensuring that the ribs on the belt are correctly engaged with the grooves in the pulleys, and that the drivebelt is correctly routed. Tension the belt as follows.

**Tensioning**

33 If not already done, proceed as described in paragraphs 2 and 3.

34 Correct tensioning of the drivebelt will ensure that it has a long life - see Haynes Hint above.

35 The belt should be tensioned so that, under firm thumb pressure, there is approximately 5.0 mm of free movement at the mid-point between the pulleys on the longest belt run (see Note at the start of this Section).

36 To adjust the tension, slacken the tensioning pulley nut and rotate the centre bolt until the correct tension is achieved. Once the belt is correctly tensioned, hold the centre bolt stationary and securely tighten the pulley nut. Rotate the crankshaft a couple of times and recheck the tension.

37 Clip the coolant hoses into position, then refit the wheel arch liner. Refit the roadwheel, and lower the vehicle to the ground.

**Automatic spring-loaded tensioning pulley**

**Removal**

38 If not already done, proceed as described in paragraphs 2 and 3.

39 Disconnect the battery negative terminal (refer to *Disconnecting the battery* in the Reference Chapter).

40 Where necessary, remove the retaining screws from the power steering pump pulley shield, and remove the shield to gain access to the top of the drivebelt.

41 Move the tensioning pulley away from the drivebelt, using a spanner on the tensioning pulley retaining nut. Rotate the tensioning pulley anti-clockwise away from the belt.

**Note:** The tensioning pulley has a left-hand

thread so it will not slacken when releasing the tension on the belt.

42 Once the tension is released, retain the pulley in the released position by inserting a 4.0 mm Allen key in the hole provided in the base of the assembly. Disengage the drivebelt from all the pulleys, noting its correct routing, and remove the drivebelt from the engine.

**Note:** If the belt is going to be re-used, mark the direction of rotation on the belt prior to removal. This will ensure it is refitted the correct way around.

**Refitting and tensioning**

43 If the belt is being renewed, ensure that the correct type is used and if the original belt is being refitted, use the mark made on removal to ensure it is fitted the correct way around. Fit the belt around the pulleys, ensuring that the ribs on the belt are correctly engaged with the grooves in the pulleys, and that the drivebelt is correctly routed.

44 Take the load off the tensioning pulley and remove the Allen key. Release the pulley and allow the tensioner to automatically tension the belt.

45 Refit the power steering pump pulley shield (where removed), and securely tighten its retaining screws.

46 Reconnect the battery negative terminal.

47 Clip the coolant hoses into position, then refit the wheel arch liner. Refit the roadwheel, and lower the vehicle to the ground.

**11 Front brake pad check**



1 Firmly apply the handbrake, then jack up the front of the car and support it securely on

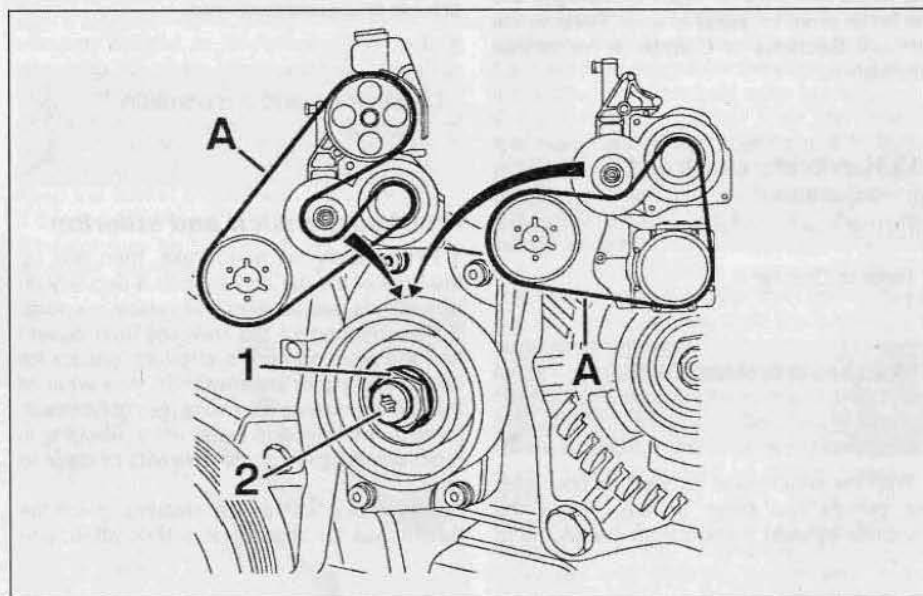

10.31 Slacken the pulley nut (1) and rotate the centre bolt (2) to adjust the drivebelt tension. Inset shows belt tension checking point (A) - models with a manually-adjusted fixed tensioning pulley

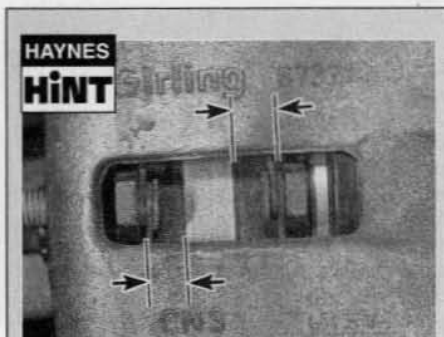

**HAYNES HINT**  
For a quick check, the thickness of friction material on each brake pad can be measured through the aperture in the caliper body.

axle stands (see *Jacking and vehicle support*). Remove the front roadwheels.

2 If any pad's friction material is worn to the specified thickness or less, all four pads must be renewed as a set.

3 For a comprehensive check, the brake pads should be removed and cleaned (see **Haynes Hint**). The operation of the caliper can then be checked, and the brake disc itself can be fully examined on both sides. Refer to Chapter 9 for details.

### 12 Rear brake shoe check



1 Remove the rear brake drums, and check the brake shoes for signs of wear or contamination. At the same time, also inspect the wheel cylinders for signs of leakage, and the brake drum for signs of wear. Refer to the relevant Sections of Chapter 9 for further information.

### 13 Handbrake check and adjustment

Refer to Chapter 9.

### 14 Exhaust system check



1 With the engine cold (at least an hour after the vehicle has been driven), check the complete exhaust system from the engine to



15.4 Check for wear in the hub bearings by grasping the wheel and trying to rock it

the end of the tailpipe. The exhaust system is most easily checked with the vehicle raised on a hoist, or suitably-supported on axle stands, so that the exhaust components are readily visible and accessible (see *Jacking and vehicle support*).

2 Check the exhaust pipes and connections for evidence of leaks, severe corrosion and damage. Make sure that all brackets and mountings are in good condition, and that all relevant nuts and bolts are tight. Leakage at any of the joints or in other parts of the system will usually show up as a black sooty stain in the vicinity of the leak.

3 Rattles and other noises can often be traced to the exhaust system, especially the brackets and mountings. Try to move the pipes and silencers. If the components are able to come into contact with the body or suspension parts, secure the system with new mountings. Otherwise separate the joints (if possible) and twist the pipes as necessary to provide additional clearance.

### 15 Steering and suspension check



#### Front suspension and steering

1 Firmly apply the handbrake, then jack up the front of the car and support it securely on axle stands (see *Jacking and vehicle support*).

2 Visually inspect the balljoint dust covers and the steering rack-and-pinion gaiters for splits, chafing or deterioration. Any wear of these components will cause loss of lubricant, together with dirt and water entry, resulting in rapid deterioration of the balljoints or steering gear.

3 On vehicles with power steering, check the fluid hoses for chafing or deterioration, and

the pipe and hose unions for fluid leaks. Also check for signs of fluid leakage under pressure from the steering gear rubber gaiters, which would indicate failed fluid seals within the steering gear.

4 Grasp the roadwheel at the 12 o'clock and 6 o'clock positions, and try to rock it (see **illustration**). Very slight free play may be felt, but if the movement is appreciable, further investigation is necessary to determine the source. Continue rocking the wheel while an assistant depresses the footbrake. If the movement is now eliminated or significantly reduced, it is likely that the hub bearings are at fault. If the free play is still evident with the footbrake depressed, then there is wear in the suspension joints or mountings.

5 Now grasp the wheel at the 9 o'clock and 3 o'clock positions, and try to rock it as before. Any movement felt now may again be caused by wear in the hub bearings or the steering track rod balljoints. If the inner or outer balljoint is worn, the visual movement will be obvious.

6 Using a large screwdriver or flat bar, check for wear in the suspension mounting bushes by levering between the relevant suspension component and its attachment point. Some movement is to be expected as the mountings are made of rubber, but excessive wear should be obvious. Also check the condition of any visible rubber bushes, looking for splits, cracks or contamination of the rubber.

7 With the car standing on its wheels, have an assistant turn the steering wheel back-and-forth about an eighth of a turn each way. There should be very little, if any, lost movement between the steering wheel and roadwheels. If this is not the case, closely observe the joints and mountings previously described, but in addition, check the steering column universal joints for wear, and the rack-and-pinion steering gear itself.

#### Strut/shock absorbers

8 Check for any signs of fluid leakage around the suspension strut/shock absorber body, or from the rubber gaiter around the piston rod. Should any fluid be noticed, the suspension strut/shock absorber is defective internally, and should be renewed.

**Note:** Suspension struts/shock absorbers should always be renewed in pairs on the same axle.

9 The efficiency of the suspension strut/shock absorber may be checked by bouncing the vehicle at each corner. Generally speaking, the body will return to its normal position and stop after being depressed. If it rises and returns on a rebound, the suspension strut/shock absorber is probably suspect. Examine also the suspension strut/shock absorber upper and lower mountings for any signs of wear.



## Every 40 000 miles (60 000 km)

### 16 Timing belt renewal

Refer to Chapter 2A.

## Every 40 000 miles (60 000 km) or two years

### 17 Brake fluid renewal



**Warning:** Brake hydraulic fluid can harm your eyes and damage painted surfaces, so use extreme caution when handling and pouring it. Do not use fluid that has been standing open for some time, as it absorbs moisture from the air. Excess moisture can cause a dangerous loss of braking effectiveness.

1 The procedure is similar to that for the bleeding of the hydraulic system as described in Chapter 9, except that the brake fluid reservoir should be emptied by syphoning,

using a clean poultry baster or similar before starting, and allowance should be made for the old fluid to be expelled when bleeding a section of the circuit.

2 Working as described in Chapter 9, open the first bleed screw in the sequence, and pump the brake pedal gently until nearly all the old fluid has been emptied from the master cylinder reservoir.



*Old hydraulic fluid is invariably much darker in colour than the new, making it easy to distinguish the two.*

3 Top-up to the MAX level with new fluid, and continue pumping until only the new fluid

remains in the reservoir, and new fluid can be seen emerging from the bleed screw. Tighten the screw, and top the reservoir level up to the MAX level line.

4 Work through all the remaining bleed screws in the sequence until new fluid can be seen at all of them. Be careful to keep the master cylinder reservoir topped-up to above the MIN level at all times, or air may enter the system and increase the length of the task.

5 When the operation is complete, check that all bleed screws are securely tightened, and that their dust caps are refitted. Wash off all traces of spilled fluid, and recheck the master cylinder reservoir fluid level.

6 Check the operation of the brakes before taking the car on the road.

## Every 40 000 miles (60 000 km) or four years

### 18 Spark plug renewal

1 The correct functioning of the spark plugs is vital for the correct running and efficiency of the engine. It is essential that the plugs fitted are appropriate for the engine (a suitable type is specified at the beginning of this Chapter). If this type is used and the engine is in good condition, the spark plugs should not need attention between scheduled renewal intervals. Spark plug cleaning is rarely necessary, and should not be attempted unless specialised equipment is available, as damage can easily be caused to the firing ends.

2 On later 1.4 litre models and all 1.6 litre models, to gain access to the spark plugs, remove the ignition HT coil as described in Chapter 5B.

3 On early 1.4 litre models, if the marks on the original-equipment spark plug (HT) leads cannot be seen, mark the leads 1 to 4, to correspond to the cylinder the lead serves (No 1 cylinder is at the transmission end of the engine). Pull the leads from the plugs by gripping the end fitting, not the lead,

otherwise the lead connection may be fractured.

4 It is advisable to remove the dirt from the spark plug recesses using a clean brush, vacuum cleaner or compressed air before removing the plugs, to prevent dirt dropping into the cylinders.

5 Unscrew the plugs using a spark plug spanner, suitable box spanner or a deep socket and extension bar (see illustration). Keep the socket aligned with the spark plug – if it is forcibly moved to one side, the ceramic insulator may be broken off. As each plug is removed, examine it as follows.



18.5 Tools required for spark plug removal, gap adjustment and refitting

6 Examination of the spark plugs will give a good indication of the condition of the engine. If the insulator nose of the spark plug is clean and white, with no deposits, this is indicative of a weak mixture or too hot a plug (a hot plug transfers heat away from the electrode slowly, a cold plug transfers heat away quickly).

7 If the tip and insulator nose are covered with hard black-looking deposits, then this is indicative that the mixture is too rich. Should the plug be black and oily, then it is likely that the engine is fairly worn, as well as the mixture being too rich.

8 If the insulator nose is covered with light tan to greyish-brown deposits, then the mixture is correct and it is likely that the engine is in good condition.

9 The spark plug electrode gap is of considerable importance as, if it is too large or too small, the size of the spark and its efficiency will be seriously impaired. Where given, the gap should be set as specified.

**Note:** Spark plugs with multiple earth electrodes are becoming an increasingly common fitment, especially to vehicles equipped with catalytic converters. Unless there is clear information to the contrary, no attempt should be made to adjust the plug gap on a spark plug with more than one earth electrode.



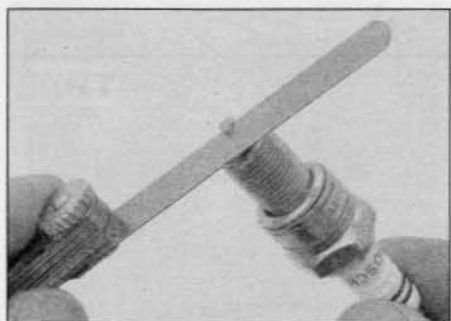

**18.10 Measuring the spark plug gap with a feeler blade**

10 To set the gap, measure it with a feeler blade, and then bend open, or closed, the outer plug electrode until the correct gap is achieved (see illustration). The centre electrode should never be bent, as this may crack the insulator and cause plug failure, if nothing worse. If using feeler blades, the gap is correct when the appropriate-size blade is a firm sliding fit.

11 Special spark plug electrode gap adjusting tools are available from most motor accessory shops, or from spark plug manufacturers.

12 Before fitting the spark plugs, check that the threaded connector sleeves are tight, and that the plug exterior and threads are clean (see Haynes Hint).

13 Remove the rubber hose (if used), and tighten the plug to the specified torque using

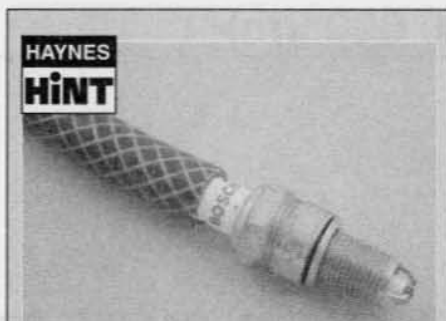

**HAYNES**  
**HINT**

*It is very often difficult to insert spark plugs into their holes without cross-threading them. To avoid this possibility, fit a short length of 5/16 inch internal diameter rubber hose over the end of the spark plug. The flexible hose acts as a universal joint to help align the plug with the plug hole. Should the plug begin to cross-thread, the hose will slip on the spark plug, preventing thread damage to the cylinder head.*

the spark plug socket and a torque wrench. Refit the remaining spark plugs in the same manner.

14 On later models, refit the ignition HT coil as described in Chapter 5B.

15 On early models, connect the HT leads in the correct order, and refit any components removed for access.

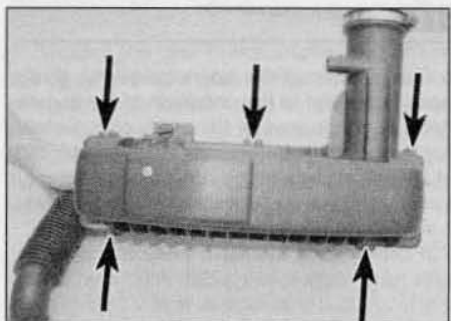

**19.2a Undo the screws (arrowed) securing the air cleaner lid to the base ...**



**19.2b ... lift off the air cleaner lid ...**

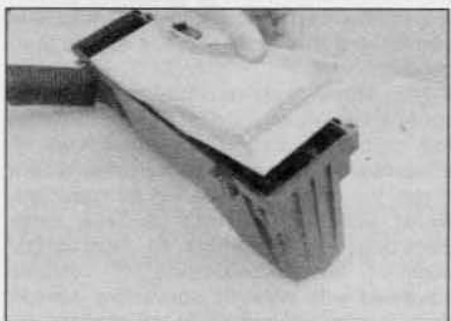

**19.2c ... and remove the air filter element**



**20.3 Depress the retaining clips and disconnect the fuel pipes from the fuel filter**

**19 Air cleaner filter element renewal**

- 1 Remove the air cleaner assembly from the car as described in Chapter 4A.
- 2 With the air cleaner assembly on the bench, undo the screws securing the air cleaner lid to the base. Lift off the lid and remove the air filter element, noting which way up it is fitted (see illustrations).
- 3 Wipe clean the inside of the air cleaner lid and base then fit the new element, ensuring it is correctly located.
- 4 Locate the lid correctly on the base and securely tighten the retaining screws.
- 5 Refit the air cleaner assembly to the car as described in Chapter 4A.

**20 Fuel filter renewal**



**Warning:** Before carrying out the following operation, refer to the precautions given in 'Safety first!' at the beginning of this manual, and follow them implicitly. Petrol is a highly-dangerous and volatile liquid, and the precautions necessary when handling it cannot be overstressed.

- 1 The fuel filter is situated underneath the rear of the vehicle, on the side of the fuel tank. To gain access to the filter, chock the front wheels then jack up the rear of the car and support it on axle stands (see *Jacking and vehicle support*).
- 2 Place a container beneath the filter to catch any spilt fuel.
- 3 Position a large rag around the fuel pipe union, to catch any fuel spray which may be expelled as the fuel pressure is released, then depress the retaining clips and slowly disconnect the fuel pipe. Disconnect the other pipe from the opposite end of the filter and allow the filter contents to drain into the container (see illustration).
- 4 Release the tab of the retaining strap and slide the fuel filter out of its holder, noting which way around it is fitted (see illustration). Dispose of



**20.4 Release the tab of the retaining strap and slide the fuel filter out of its holder**

the old filter safely; it will be highly inflammable, and may explode if thrown on a fire.

5 Slide the new filter into position, ensuring it is fitted the correct way around; the filter will either have an arrow on its body (indicating the correct direction of fuel flow) or be stamped OUT on one end (indicating the fuel outlet end of the filter).

6 Ensure the filter is clipped securely in its holder then reconnect both fuel pipes. Ensure the pipes 'click' into position on the filter and are securely retained by their quick-release fittings.

7 Start the engine and check the fuel filter for signs leaks.

## 21 Manual transmission oil level check

**Note:** A suitable square-section wrench may be required to undo the transmission filler/level plug on some models. These wrenches can be obtained from most motor factors or your Peugeot/Citroën dealer.

1 Park the car on a level surface. The oil level must be checked before the car is driven, or at least 5 minutes after the engine has been switched off. If the oil is checked immediately after driving the car, some of the oil will remain distributed around the transmission, resulting in an inaccurate level reading.

2 Prise out the clips and remove the access cover from the left-hand wheel arch liner.

3 Wipe clean the area around the filler/level plug, which is on the left-hand end of the transmission (see illustrations). Unscrew the plug and clean it; discard the sealing washer.

4 The oil level should reach the lower edge of the filler/level hole. A certain amount of oil will have gathered behind the filler/level plug, and will trickle out when it is removed; this does not necessarily indicate that the level is correct. To ensure that a true level is established, wait until the initial trickle has stopped, then add oil as necessary until a trickle of new oil can be seen emerging. The level will be correct when the flow ceases; use only good-quality oil of the specified type (refer to *Lubricants and fluids*).

5 Filling the transmission with oil is an extremely awkward operation; above all, allow plenty of time for the oil level to settle properly before checking it. If a large amount is added to the transmission, and a large amount flows out on checking the level, refit the filler/level plug and take the vehicle on a short journey so that the new oil is distributed fully around the transmission components, then recheck the level when it has settled again.

6 If the transmission has been overfilled so that oil flows out as soon as the filler/level plug is removed, check that the car is completely level (front-to-rear and side-to-side), and allow the surplus to drain off into a container.

7 When the level is correct, fit a new sealing washer to the filler/level plug. Refit the plug, tightening it to the specified torque setting.

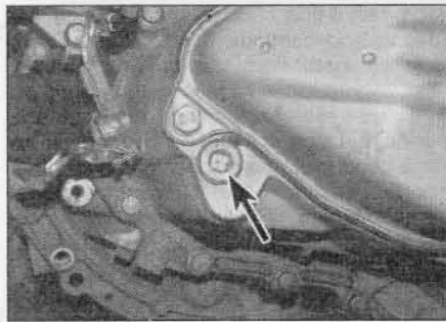

21.3a Oil filler/level plug (arrowed) – 1.4 litre models

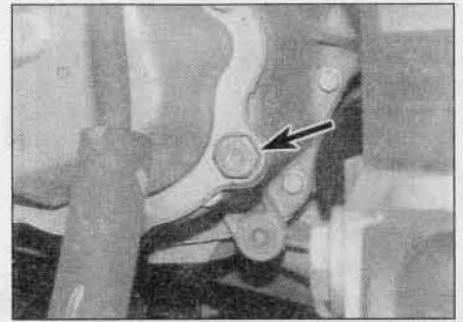

21.3b Oil filler/level plug (arrowed) – 1.6 litre models

Wash off any spilt oil then refit the access cover securing it in position with the clips.

## 22 Emissions control systems check

1 Details of the emissions control system components are given in Chapter 4D.

2 Checking consists simply of a visual check for obvious signs of damaged or leaking hoses and joints.

3 Detailed checking of the evaporative and/or exhaust emissions systems (as applicable) should be entrusted to a Peugeot/Citroën dealer.

## 23 Coolant renewal



**Warning:** Wait until the engine is cold before starting this procedure. Do not allow antifreeze to come in contact with your skin, or with the painted surfaces of the vehicle. Rinse off spills immediately with plenty of water. Never leave antifreeze lying around in an open container, or in a puddle in the driveway or on the garage floor. Children and pets are attracted by its sweet smell, but antifreeze can be fatal if ingested.

### Cooling system draining

1 With the engine completely cold, remove

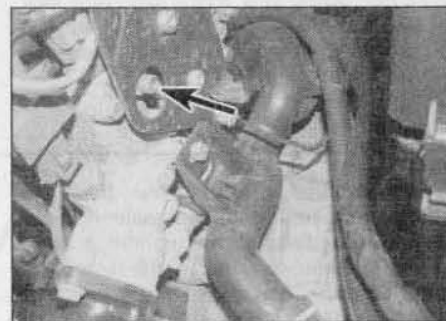

23.3b ... thermostat housing bleed screw (arrowed) ...

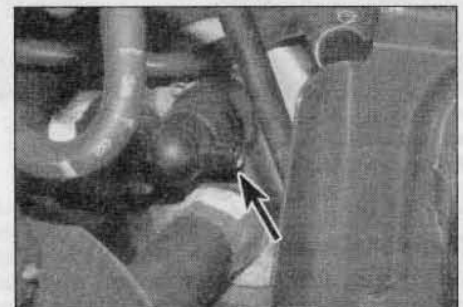

23.3a Heater matrix bleed screw (arrowed) ...

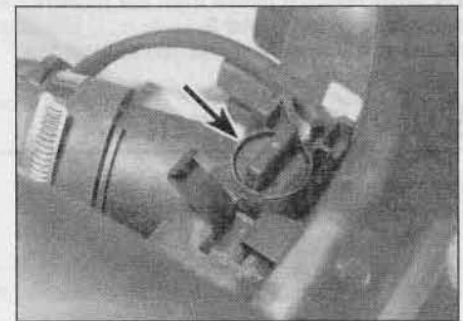

23.3c ... and radiator bleed screw (arrowed)

the expansion tank filler cap. Turn the cap anti-clockwise until it reaches the first stop. Wait until any pressure remaining in the system is released, then push the cap down, turn it anti-clockwise to the second stop, and lift it off.

2 Position a suitable container beneath the lower left-hand side of the radiator. On early models, loosen the drain plug (there is no need to remove it completely) and allow the coolant to drain into the container. On later models a drain plug is not provided, so it will be necessary to disconnect the radiator bottom hose to allow the coolant to drain.

3 To assist draining, open the cooling system bleed screws. These are located in the heater matrix outlet hose union (to improve access, it may be located in an extension hose), on the engine compartment bulkhead, and on the thermostat housing. On some models, there may also be a bleed screw in the top left-hand end of the radiator (see illustrations).



**HAYNES  
HINT**



**Cut the bottom off an old antifreeze container to make a 'header tank' for use when refilling the cooling system. The seal at the point arrowed must be as airtight as possible.**

**4** When the flow of coolant stops, reposition the container below the cylinder block drain plug located at the front left-hand side of the cylinder block.

**5** Remove the drain plug, and allow the coolant to drain into the container.

**6** If the coolant has been drained for a reason other than renewal, then provided it is clean and less than four years old, it can be re-used, though this is not recommended.

**7** Refit the radiator and cylinder block drain plugs on completion of draining. Also refit the radiator bottom hose (later models) if the system is not to be flushed.

### Cooling system flushing

**8** If coolant renewal has been neglected, or if the antifreeze mixture has become diluted, then in time, the cooling system may gradually lose efficiency, as the coolant passages become restricted due to rust, scale deposits, and other sediment. The cooling system efficiency can be restored by flushing the system clean.

**9** The radiator should be flushed separately from the engine, to avoid excess contamination.

### Radiator flushing

**10** To flush the radiator, first tighten the radiator drain plug, and the radiator bleed screw, where applicable.

**11** Disconnect the top and bottom hoses and any other relevant hoses from the radiator, with reference to Chapter 3.

**12** Insert a garden hose into the radiator top

inlet. Direct a flow of clean water through the radiator, and continue flushing until clean water emerges from the radiator bottom outlet.

**13** If after a reasonable period, the water still does not run clear, the radiator can be flushed with a good proprietary cleaning agent. It is important that their manufacturer's instructions are followed carefully. If the contamination is particularly bad, insert the hose in the radiator bottom outlet, and reverse-flush the radiator.

### Engine flushing

**14** To flush the engine, first refit the cylinder block drain plug, and tighten the cooling system bleed screws.

**15** Remove the thermostat (see Chapter 3), then temporarily refit the thermostat cover.

**16** With the top and bottom hoses disconnected from the radiator, insert a garden hose into the radiator top hose. Direct a clean flow of water through the engine, and continue flushing until clean water emerges from the radiator bottom hose.

**17** When flushing is complete, refit the thermostat and reconnect the hoses with reference to Chapter 3.

### Cooling system filling

**18** Before attempting to fill the cooling system, make sure that all hoses and clips are in good condition, and that the clips are tight. Note that an antifreeze mixture must be used all year round, to prevent corrosion of the engine components (see following sub-Section). Also check that the radiator and cylinder block drain plugs are in place and tight.

**19** Remove the expansion tank filler cap.

**20** Open all the cooling system bleed screws (see paragraph 3).

**21** Some of the cooling system hoses are positioned at a higher level than the top of the radiator expansion tank. It is therefore necessary to use a 'header tank' when refilling the cooling system, to reduce the possibility of air being trapped in the system. Although Peugeot/Citroën dealers use a special header tank, the same effect can be achieved by using a suitable bottle, with a seal between the bottle and the expansion tank (see **Haynes Hint**).

**22** Fit the 'header tank' to the expansion tank and slowly fill the system. Coolant will emerge from each of the bleed screws in turn, starting

with the lowest screw. As soon as coolant free from air bubbles emerges from the lowest screw, tighten that screw, and watch the next bleed screw in the system. Repeat the procedure until the coolant is emerging from the highest bleed screw in the cooling system and all bleed screws are securely tightened.

**23** Continue to fill the cooling system until bubbles stop appearing in the expansion tank. Help to bleed the air from the system by repeatedly squeezing the radiator bottom hose.

**24** When no more bubbles appear, ensure the header tank is full (at least 1.0 litre of coolant) then start the engine. Run the engine at a fast idle speed (do not exceed 2000 rpm) until the cooling fan cuts in and out TWICE, then when the fan has stopped for the second time, switch the engine off.

**Caution: The coolant will be hot. Take great care not to scald yourself.**

**25** Allow the engine to cool, then remove the 'header tank'.

**26** When the engine has cooled, check the coolant level with reference to *Weekly checks*. Top-up the level if necessary, and refit the expansion tank cap.

### Antifreeze mixture

**27** The antifreeze should always be renewed at the specified intervals. This is necessary not only to maintain the antifreeze properties, but also to prevent corrosion which would otherwise occur as the corrosion inhibitors become progressively less effective.

**28** Always use an ethylene-glycol based antifreeze of the specified type (see *Lubricants and fluids*). The quantity of antifreeze and level of protection are indicated in the Specifications.

**29** Before adding antifreeze, the cooling system should be completely drained, preferably flushed, and all hoses checked for condition and security.

**30** After filling with antifreeze, a label should be attached to the expansion tank, stating the type and concentration of antifreeze used, and the date installed. Any subsequent topping-up should be made with the same type and concentration of antifreeze.

**31** Do not use engine antifreeze in the windscreen/tailgate washer system, as it will damage the vehicle paintwork. A screenwash additive should be added to the washer system in the quantities stated on the bottle.

## Every ten years

### 24 Airbags and seat belt pretensioners renewal



**1** Peugeot/Citroën recommend that the airbags and seat belt pretensioners are renewed regardless of their condition every ten years. Refer to Chapter 12 for airbag renewal, and Chapter 11 for seat belt pretensioner renewal.



# Chapter 1 Part B:

## Routine maintenance and servicing – diesel models

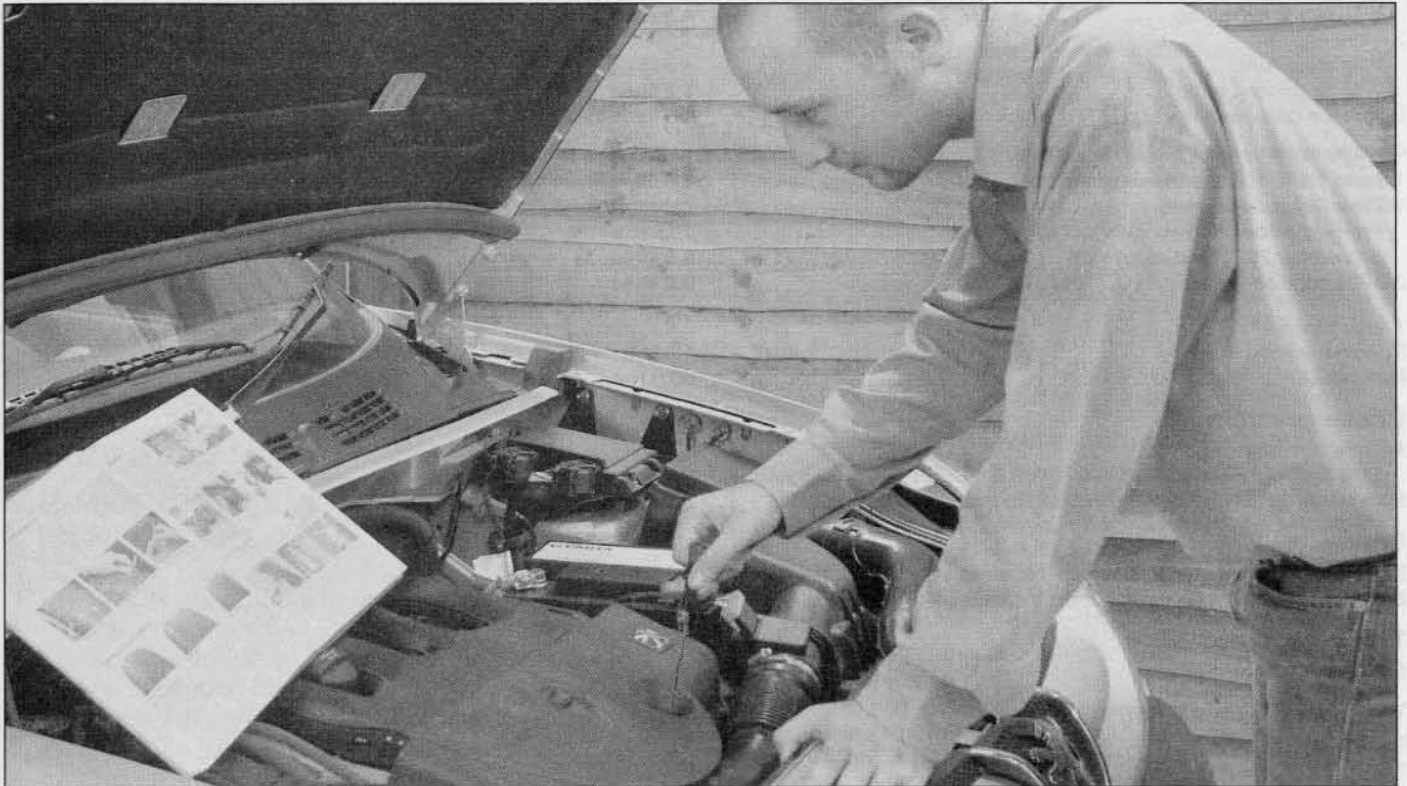

### Contents

	Section number		Section number
Airbags and seat belt pretensioners renewal .....	26	Handbrake check and adjustment .....	16
Air cleaner filter element renewal .....	20	Hinge and lock lubrication .....	7
Auxiliary drivebelt check and renewal – 1.8 and 1.9 litre engines .....	12	Hose and fluid leak check .....	5
Auxiliary drivebelt check and renewal – 2.0 litre engines .....	13	Idle speed and anti-stall speed check and adjustment –	
Brake fluid renewal .....	24	1.8 and 1.9 litre engines .....	11
Coolant renewal .....	25	Manual transmission oil level check .....	21
Driveshaft gaiter check .....	6	Pollen filter renewal .....	10
Emissions control systems check .....	22	Rear brake shoe check .....	15
Exhaust system check .....	17	Resetting the service indicator .....	9
Engine oil and filter renewal .....	3	Road test .....	8
Front brake pad check .....	14	Routine maintenance .....	2
Fuel filter renewal .....	19	Steering and suspension check .....	18
Fuel filter water draining .....	4	Timing belt renewal .....	23
General information .....	1		

### Degrees of difficulty

**Easy**, suitable for novice with little experience



**Fairly easy**, suitable for beginner with some experience



**Fairly difficult**, suitable for competent DIY mechanic



**Difficult**, suitable for experienced DIY mechanic



**Very difficult**, suitable for expert DIY or professional



# 1B•2 Specifications – diesel models

## Lubricants and fluids

Refer to *Weekly checks*

## Capacities (approximate)

### Engine oil (including filter)

1.8 and 1.9 litre XUD series engines:	
With steel sump	4.2 litres
With aluminium sump	4.0 litres
1.9 litre DW series engines:	
With steel sump	4.7 litres
With aluminium sump	4.5 litres
2.0 litre engines:	
With steel sump	4.5 litres
With aluminium sump	4.2 litres
Difference between MAX and MIN dipstick marks	1.5 litres

### Cooling system

1.8 and 1.9 litre XUD series engines	8.0 litres
1.9 litre DW series engines:	
Pre-September 2002 models	10.5 litres
September 2002 models onward	9.0 litres
2.0 litre engines	9.0 litres

Transmission ..... 2.0 litres

Power-assisted steering ..... 1.0 litre

Fuel tank ..... 60.0 litres

## Cooling system

Antifreeze mixture:  
50% antifreeze ..... Protection down to  $-35^{\circ}\text{C}$

**Note:** Refer to antifreeze manufacturer for latest recommendations.

## Brakes

Brake pad friction material minimum thickness	2.0 mm
Brake shoe friction material minimum thickness	1.5 mm

## Tyre pressures

See end of *Weekly checks*

## Torque wrench settings

	Nm	lbf ft
Roadwheel bolts	90	66
Transmission filler/level plugs	25	18

**Note:** This maintenance schedule is a guide recommended by Haynes, for servicing your own vehicle. For the manufacturer's maintenance schedule, check with your local dealer.

The maintenance intervals in this manual are provided with the assumption that you, not the dealer, will be carrying out the work. These are the minimum maintenance intervals

recommended by us for vehicles driven daily. If you wish to keep your vehicle in peak condition at all times, you may wish to perform some of these procedures more often. We encourage frequent maintenance, because it enhances the efficiency, performance and resale value of your vehicle.

If the vehicle is driven in dusty areas, used

to tow a trailer, or driven frequently at slow speeds (idling in traffic) or on short journeys, more frequent maintenance intervals are recommended.

When the vehicle is new, it should be serviced by a factory-authorised dealer service department, in order to preserve the factory warranty.

## Every 250 miles (400 km) or weekly

- Refer to *Weekly checks*

## Every 5000 miles (7500 km) or 12 months – whichever comes first

- Renew the engine oil and filter (Section 3)\*.
- Drain any water from the fuel filter (Section 4).
- Check all underbonnet components or fluid leaks (Section 5).
- Check the condition of the driveshaft rubber gaiters (Section 6).
- Lubricate all hinges and locks (Section 7).
- Carry out a road test (Section 8).
- Reset the service interval indicator (Section 9).

**\*Note:** On 1.9 litre (DW series) engines, Peugeot/Citroën recommend the engine oil and filter are changed every 10 000 miles or two years. However, oil and filter changes are good for the engine and we recommend that the oil and filter are renewed at least once a year, especially if the vehicle is used on a lot of short journeys.

## Every 10 000 miles (15 000 km) or two years – whichever comes first

- Check the pollen filter (Section 10).
- Check the idle speed and anti-stall speed (Section 11).
- Check the condition of the auxiliary drivebelt (Section 12).
- Check the condition of the front brake pads (Section 14).
- Check the condition of the rear brake shoes (Section 15).
- Check the operation of the handbrake (Section 16).
- Check the condition of the exhaust system (Section 17).
- Check the steering and suspension components (Section 18).

## Every 30 000 miles (45 000 km) or four years – whichever comes first

- Renew the fuel filter (Section 19).
- Renew the air cleaner filter element (Section 20).
- Check the manual transmission oil level (Section 21).
- Check the exhaust emissions (Section 22).

## Every 40 000 miles (60 000 km)

- Renew the timing belt (Section 23).

**Note:** Although the normal interval for timing belt renewal is 80 000 miles (120 000 km), it is strongly recommended that the interval is reduced to 40 000 miles (60 000 km), especially on vehicles which are subjected to intensive use, ie, mainly short journeys or a lot of stop-start driving. The actual belt renewal interval is therefore very much up to the individual owner, but bear in mind that severe engine damage will result if the belt breaks.

## Every 40 000 miles (60 000 km) or two years – whichever comes first

- Renew the brake fluid (Section 24).

## Every 40 000 miles (60 000 km) or four years – whichever comes first

- Renew the coolant (Section 25).

## Every ten years

- Renew the airbags and seat belt pretensioners (Section 26).



**Note:** This maintenance schedule is a guide recommended by Haynes, for servicing your own vehicle. For the manufacturer's maintenance schedule, check with your local dealer.

The maintenance intervals in this manual are provided with the assumption that you, not the dealer, will be carrying out the work. These are the minimum maintenance intervals

recommended by us for vehicles driven daily. If you wish to keep your vehicle in peak condition at all times, you may wish to perform some of these procedures more often. We encourage frequent maintenance, because it enhances the efficiency, performance and resale value of your vehicle.

If the vehicle is driven in dusty areas, used

to tow a trailer, or driven frequently at slow speeds (idling in traffic) or on short journeys, more frequent maintenance intervals are recommended.

When the vehicle is new, it should be serviced by a factory-authorised dealer service department, in order to preserve the factory warranty.

### Every 250 miles (400 km) or weekly

- Refer to *Weekly checks*

### Every 6000 miles (10 000 km) or 12 months – whichever comes first

- Renew the engine oil and filter (Section 3)\*.
- Drain any water from the fuel filter (Section 4).
- Check all underbonnet components or fluid leaks (Section 5).
- Check the condition of the driveshaft rubber gaiters (Section 6).
- Lubricate all hinges and locks (Section 7).
- Carry out a road test (Section 8).
- Reset the service interval indicator (Section 9).

**\*Note:** Peugeot/Citroën recommend the engine oil and filter are changed every 12 000 miles or two years. However, oil and filter changes are good for the engine and we recommend that the oil and filter are renewed at least once a year, especially if the vehicle is used on a lot of short journeys.

### Every 12 000 miles (20 000 km) or two years – whichever comes first

- Check the pollen filter (Section 10).
- Check the condition of the auxiliary drivebelt (Section 13).
- Check the condition of the front brake pads (Section 14).
- Check the condition of the rear brake shoes (Section 15).
- Check the operation of the handbrake (Section 16).
- Check the condition of the exhaust system (Section 17).
- Check the steering and suspension components (Section 18).

### Every 36 000 miles (60 000 km) or two years – whichever comes first

- Renew the brake fluid (Section 24).

### Every 36 000 miles (60 000 km) or 4 years – whichever comes first

- Renew the fuel filter (Section 19).
- Renew the air cleaner filter element (Section 20).
- Check the manual transmission oil level (Section 21).
- Check the exhaust emissions (Section 22).
- Renew the coolant (Section 25).

### Every 48 000 miles (80 000 km)

- Renew the timing belt (Section 23).

**Note:** Although the normal interval for timing belt renewal is 96 000 miles (160 000 km), it is strongly recommended that the interval is reduced to 48 000 miles (80 000 km), especially on vehicles which are subjected to intensive use, ie, mainly short journeys or a lot of stop-start driving. The actual belt renewal interval is therefore very much up to the individual owner, but bear in mind that severe engine damage will result if the belt breaks.

### Every ten years

- Renew the airbags and seat belt pretensioners (Section 26).

## Underbonnet view of a pre-September 2002 1.9 litre model (DW series)

- 1 Engine oil filler cap
- 2 Engine oil dipstick
- 3 Battery
- 4 Master cylinder brake fluid reservoir
- 5 Fuse/relay box
- 6 Cooling system expansion tank
- 7 Windscreen/tailgate washer fluid reservoir
- 8 Power steering fluid reservoir
- 9 Suspension strut upper mounting
- 10 Engine management ECU

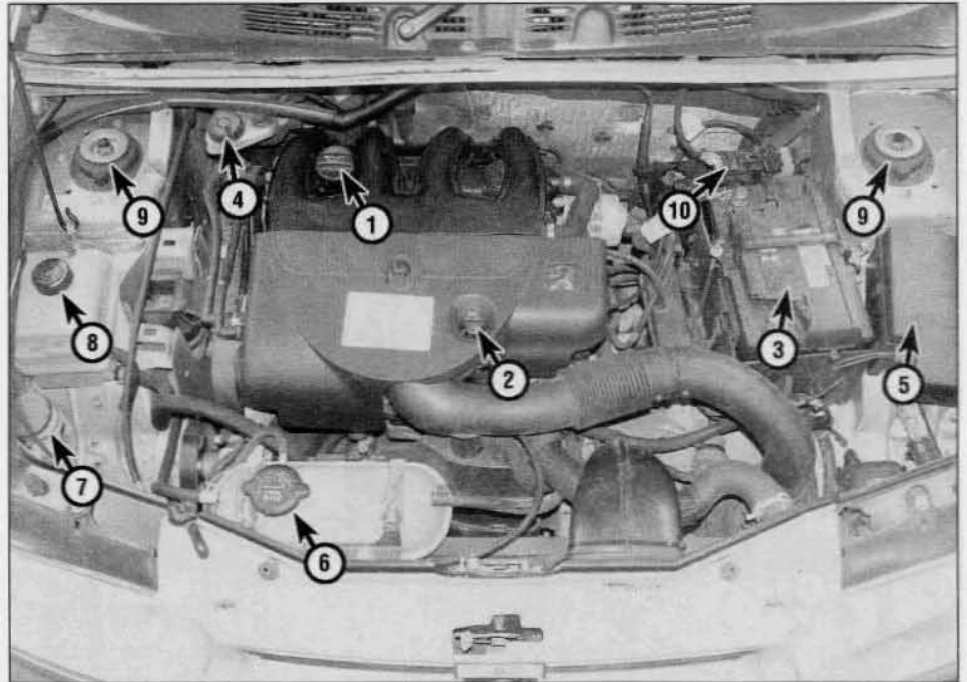

## Underbonnet view of a post-September 2002 1.9 litre model (DW series)

- 1 Engine oil filler cap
- 2 Engine oil dipstick
- 3 Battery
- 4 Master cylinder brake fluid reservoir
- 5 Fuse/relay box
- 6 Cooling system expansion tank
- 7 Windscreen/tailgate washer fluid reservoir
- 8 Power steering fluid reservoir
- 9 Suspension strut upper mounting
- 10 Engine management ECU
- 11 Airflow meter
- 12 Air cleaner housing

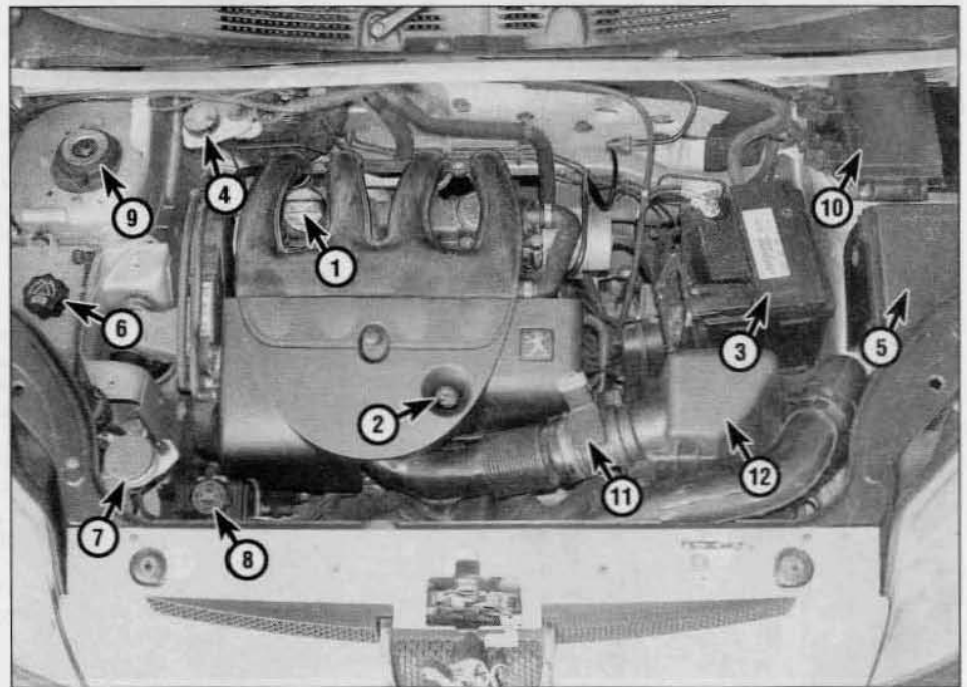

## 1B•6 Routine maintenance and servicing – diesel models

### Underbonnet view of a 2.0 litre model

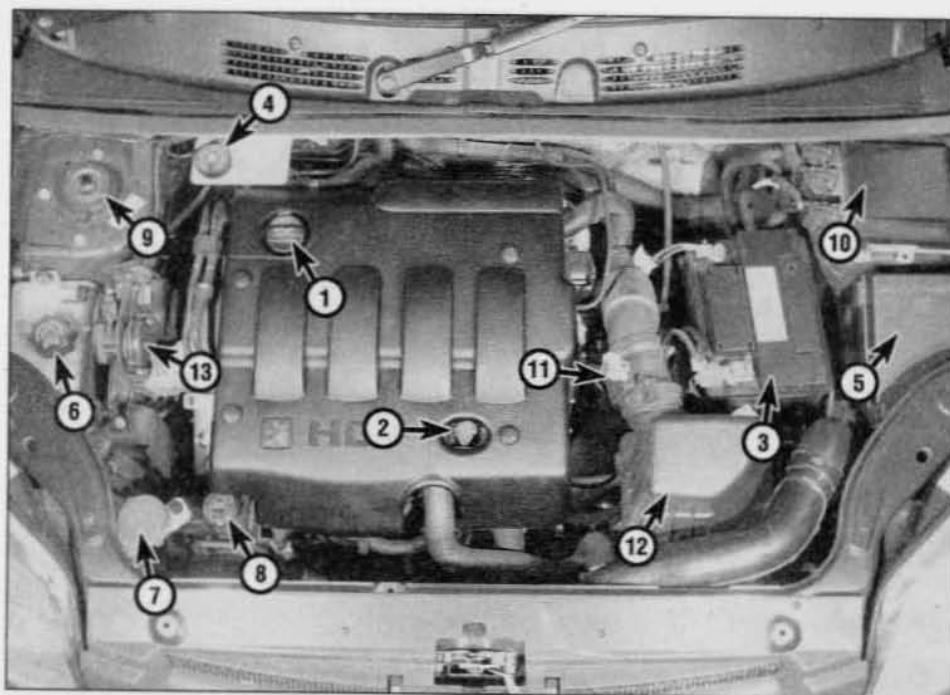

- 1 Engine oil filler cap
- 2 Engine oil dipstick
- 3 Battery
- 4 Master cylinder brake fluid reservoir
- 5 Fuse/relay box
- 6 Cooling system expansion tank
- 7 Windscreen/tailgate washer fluid reservoir
- 8 Power steering fluid reservoir
- 9 Suspension strut upper mounting
- 10 Engine management ECU
- 11 Airflow meter
- 12 Air cleaner housing
- 13 Accelerator pedal position sensor

### Front underbody view

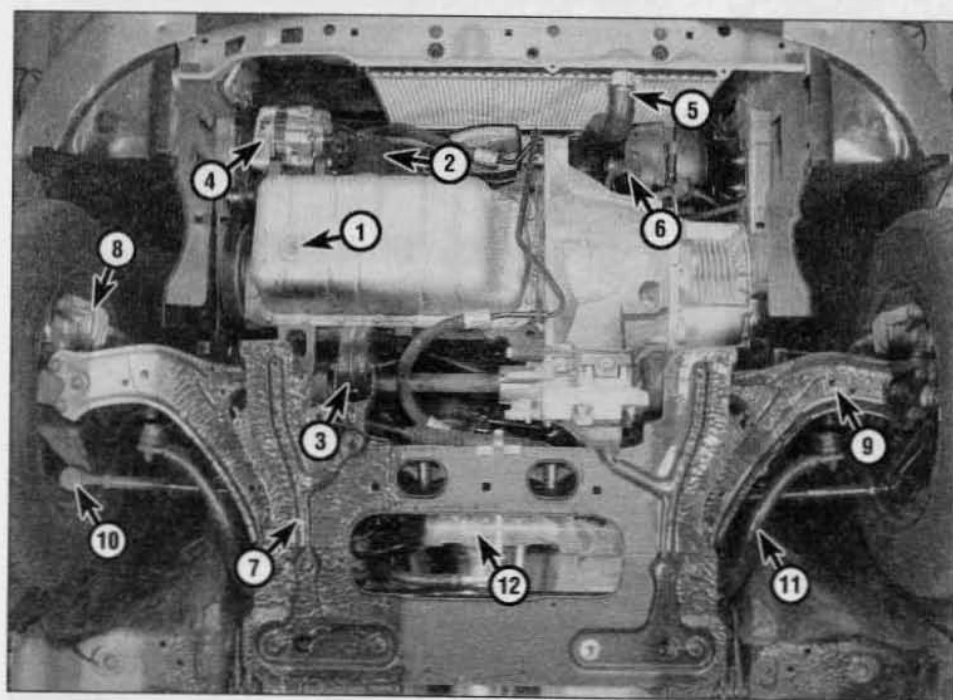

- 1 Sump drain plug
- 2 Oil filter
- 3 Engine/transmission rear mounting
- 4 Alternator
- 5 Radiator bottom hose
- 6 Clutch cable
- 7 Front suspension subframe
- 8 Front brake caliper
- 9 Front suspension lower arm
- 10 Track rod balljoint
- 11 Front anti-roll bar
- 12 Steering gear assembly



## Rear underbody view

- 1 Spare wheel
- 2 Rear silencer
- 3 Fuel tank
- 4 Handbrake cable
- 5 Rear suspension torsion bar
- 6 Rear suspension tubular crossmember
- 7 Rear shock absorber
- 8 Rear suspension trailing arm

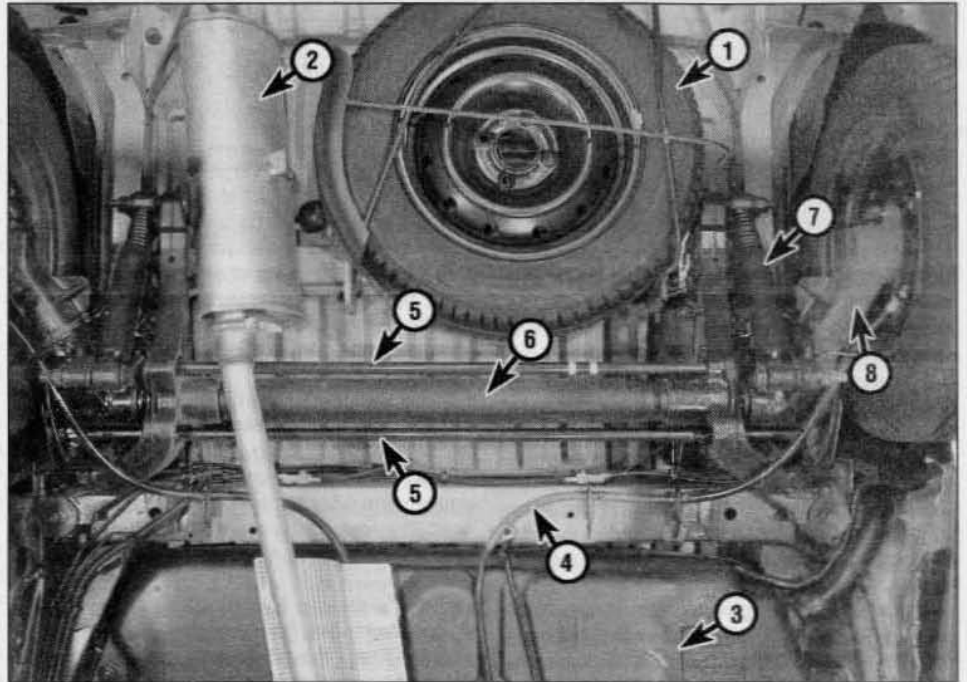

### 1 General information

This Chapter is designed to help the home mechanic maintain his/her vehicle for safety, economy, long life and peak performance.

The Chapter contains a master maintenance schedule, followed by Sections dealing specifically with each task in the schedule. Visual checks, adjustments, component renewal and other helpful items are included. Refer to the accompanying illustrations of the engine compartment and the underside of the vehicle for the locations of the various components.

Servicing your vehicle in accordance with the mileage/time maintenance schedule and the following Sections will provide a planned maintenance programme, which should result in a long and reliable service life. This is a comprehensive plan, so maintaining some items but not others at the specified service intervals will not produce the same results.

As you service your vehicle, you will discover that many of the procedures can – and should – be grouped together, because of the particular procedure being performed, or because of the proximity of two otherwise-unrelated components to one another. For example, if the vehicle is raised for any reason, the exhaust can be inspected at the same time as the suspension and steering components.

The first step in this maintenance

programme is to prepare yourself before the actual work begins. Read through all the Sections relevant to the work to be carried out, then make a list and gather all the parts and tools required. If a problem is encountered, seek advice from a parts specialist, or a dealer service department.

### 2 Routine maintenance

**1** If, from the time the vehicle is new, the routine maintenance schedule is followed closely, and frequent checks are made of fluid levels and high-wear items, as suggested throughout this manual, the engine will be kept in relatively good running condition, and the need for additional work will be minimised.

**2** It is possible that there will be times when the engine is running poorly due to the lack of regular maintenance. This is even more likely if a used vehicle, which has not received regular and frequent maintenance checks, is purchased. In such cases, additional work may need to be carried out, outside of the regular maintenance intervals.

**3** If engine wear is suspected, a compression test or leakdown test (refer to the relevant Part of Chapter 2) will provide valuable information regarding the overall performance of the main internal components. Such a test can be used as a basis to decide on the extent of the work to be carried out. If, for example, a compression or leakdown test indicates

serious internal engine wear, conventional maintenance as described in this Chapter will not greatly improve the performance of the engine, and may prove a waste of time and money, unless extensive overhaul work is carried out first.

**4** The following series of operations are those most often required to improve the performance of a generally poor-running engine:

#### Primary operations

- a) Clean, inspect and test the battery (See 'Weekly checks').
- b) Check all the engine-related fluids (See 'Weekly checks').
- c) Check the condition and tension of the auxiliary drivebelt (Sections 12 and 13).
- d) Check the condition of the air cleaner filter element, and renew if necessary (Section 20).
- e) Check the fuel filter (Section 19).
- f) Check the condition of all hoses, and check for fluid leaks (Section 5).
- g) Check the idle speed and anti-stall speed – 1.8 and 1.9 litre engines (Section 11).

**5** If the above operations do not prove fully effective, carry out the following secondary operations:

#### Secondary operations

All items listed under *Primary operations*, plus the following:

- a) Check the charging system (Chapter 5A).
- b) Check the preheating system (Chapter 5C).
- c) Check the fuel system (Chapter 4B or 4C).

**Every 5000/6000 miles (7500/10 000 km) or 12 months****1.8 and 1.9 litre engines – every 5000 miles (7500 km)****2.0 litre engines – every 6000 miles (10 000 km)****3 Engine oil and filter renewal**

**Note:** A suitable square-section wrench may be required on some models to undo the sump drain plug. These wrenches can be obtained from most motor factors, or from your Peugeot/Citroën dealer.

**1** Frequent oil and filter changes are among the most important preventative maintenance procedures for the DIY owner. As engine oil ages, it becomes diluted and contaminated, which leads to premature engine wear.

**2** Before starting this procedure, gather together all the necessary tools and materials. Also make sure that you have plenty of clean rags and newspapers handy, to mop-up any spills. Ideally, the engine oil should be warm, as it will drain better, and more built-up sludge will be removed with it. Take care, however, not to touch the exhaust or any other hot parts of the engine when working under the vehicle. To avoid any possibility of scalding, and to protect yourself from possible skin irritants and other harmful contaminants in used engine oils, it is advisable to wear gloves when carrying out this work. Access to the underside of the vehicle will be greatly improved if it can be raised on a lift, driven onto ramps, or jacked up and supported on axle stands (see *Jacking and vehicle support*). Whichever method is chosen, make sure that the vehicle remains level, or if it is at an angle, that the drain plug is at the lowest point. Where fitted, undo the retaining screws and remove the engine undertray.

**3** Slacken the drain plug about half a turn; on some models, a square-section wrench may be needed to slacken the plug (see *illustration*). Position the draining container under the drain plug, then remove the plug completely. If possible, try to keep the plug pressed into the



**3.3** Slackening the sump drain plug with a square-section wrench

sump while unscrewing it by hand the last couple of turns (see *Haynes Hint*). Recover the sealing ring from the drain plug.

**4** Allow some time for the old oil to drain, noting that it may be necessary to reposition the container as the oil flow slows to a trickle.

**5** After all the oil has drained, wipe off the drain plug with a clean rag, and fit a new sealing washer. Clean the area around the drain plug opening, and refit the plug. Tighten the plug securely.

**6** Move the container into position under the oil filter, which is located on the front side of the cylinder block, below the inlet manifold.

**7** Using an oil filter removal tool if necessary, slacken the filter initially, then unscrew it by hand the rest of the way (see *illustration*). Empty the oil in the old filter into the container.

**8** Use a clean rag to remove all oil, dirt and sludge from the filter sealing area on the engine. Check the old filter to make sure that the rubber sealing ring hasn't stuck to the engine. If it has, carefully remove it.

**9** Apply a light coating of clean engine oil to the sealing ring on the new filter, then screw it into position on the engine. Tighten the filter firmly by hand only – **do not** use any tools.

**10** Remove the old oil and all tools from under the car, then lower the car to the ground (if applicable).

**11** Remove the dipstick, then unscrew the oil filler cap from the cylinder head cover or oil filler/breather neck (as applicable). Fill the engine, using the correct grade and type of oil (see *Weekly checks*). An oil can spout or funnel may help to reduce spillage. Pour in half the specified quantity of oil first, then wait a few minutes for the oil to fall to the sump. Continue adding oil a small quantity at a time until the level is up to the lower mark on the

**HAYNES  
HINT**



As the drain plug releases from the threads, move it away sharply so the stream of oil issuing from the sump runs into the container, not up your sleeve

dipstick. Adding approximately 1.5 litres will bring the level up to the upper mark on the dipstick. Refit the filler cap.

**12** Start the engine and run it for a few minutes; check for leaks around the oil filter seal and the sump drain plug. Note that there may be a brief delay before the oil pressure warning light goes out when the engine is first started, as the oil circulates through the engine oil galleries and the new oil filter (where fitted) before the pressure builds-up.

**13** Switch off the engine, and wait a few minutes for the oil to settle in the sump once more. With the new oil circulated and the filter completely full, recheck the level on the dipstick, and add more oil as necessary.

**14** Dispose of the used engine oil and filter safely, with reference to *General repair procedures* at the rear of this manual. Do not discard the old filter with domestic household waste. The facility for waste oil disposal provided by many local council refuse tips generally has a filter receptacle alongside.

**4 Fuel filter water draining**

**HAYNES  
HINT**

This is a somewhat messy operation. Wear disposable plastic gloves and spread out a good quantity of rags or newspapers to catch any spillage. Be particularly careful not to spill fuel onto cooling system hoses, wiring harnesses, engine mountings or accessory drivebelts; protect them with a plastic sheet. Catch the fuel in a clean container in order to be able to observe any water or foreign bodies drained from the filter.

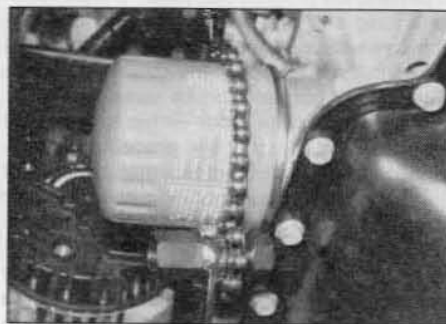

**3.7** Using an oil filter removal tool to slacken the oil filter



**1.8 and 1.9 litre XUD series engines**

- 1 A water drain plug and tube are provided at the base of the fuel filter housing.
- 2 Place a suitable container beneath the drain tube, and cover the clutch bellhousing.
- 3 Open the drain plug by turning it anti-clockwise, and allow fuel and water to drain until fuel, free from water, emerges from the end of the tube (see illustration). Close the drain plug, and tighten it securely.
- 4 Dispose of the drained fuel safely.
- 5 Start the engine. If difficulty is experienced, prime the fuel system (see Chapter 4B).

**1.9 litre DW series engines**

- 6 Release the fasteners from the right-hand side and top of the engine cover then lift off the cover, taking care not to lose its mounting rubbers (see illustrations).
- 7 Wipe clean the exterior of the fuel filter housing then position a suitable container beneath the drain plug at the base of the housing (see illustration). If necessary attach a short length of hose to the housing drain outlet to allow the flow of fuel to be directed into the container (on some models a hose may be fitted in production).
- 8 Open the drain plug by turning it anti-clockwise. Operate the priming pump on the side of the filter housing to allow fuel and water to drain. Continue until fuel, free from water, emerges from the end of the hose. Close the drain plug, and tighten it securely.
- 9 Dispose of the drained fuel safely.
- 10 Refit the engine cover and start the

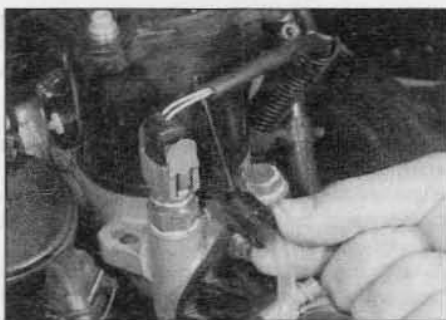

4.3 Opening the fuel filter drain plug – XUD series engines



4.6a On 1.9 litre DW series engines, remove the fasteners from the right-hand side ...

engine. If difficulty is experienced, prime the fuel system (see Chapter 4C).

**2.0 litre engines**

**Caution:** It is vital to observe the intervals specified for draining the water from the fuel filter. The high pressure injection system is particularly susceptible to the presence of water in the fuel, which can cause seizure of the injectors and/or injection pump. The result is the destruction of the engine, either as a result of the 'blowlamp' effect of an injector stuck open, or by breakage of the timing belt consequent upon the seizure of the pump. **Note:** Always renew the drain plug and its O-ring after each draining. On completion, prime the fuel system (see Chapter 4C) and make sure that there are no signs of leakage at the drain plug after restarting the engine.

- 11 Release the fixings by turning them through 90°, and remove the engine cover (see illustrations).
- 12 Cover the clutch bellhousing with rags to protect it from any fuel spillage.
- 13 Clean the outside of the filter housing, then place a suitable container below the drain plug at the base of the housing (see illustration). If necessary attach a short length of hose to the housing drain outlet to allow the flow of fuel to be directed into the container (on some models a hose may be fitted in production).
- 14 Undo the drain plug and allow the contents of the filter housing to drain into the container. Note that it may be necessary to release one of the fuel hose unions on the filter housing cover to allow the draining to take place. Discard the drain plug and its O-ring.



4.6b ... and top of the engine cover ...



4.6c ... then remove the cover from the engine

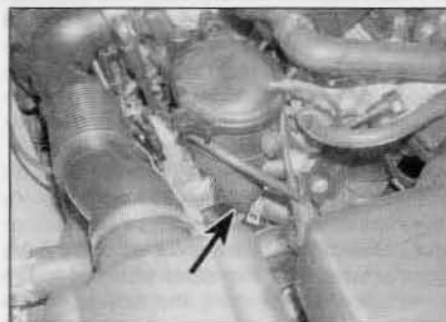

4.7 Fuel filter drain plug location – 1.9 litre DW series engines



4.11a Release the fixings by turning them through 90° ...

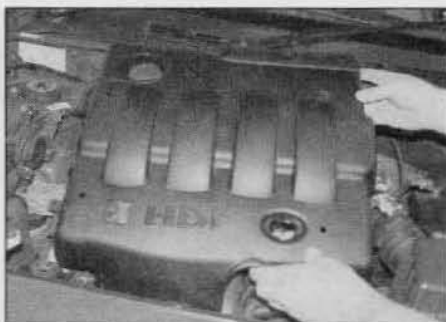

4.11b ... and remove the engine cover



4.13 Fuel filter drain plug location – 2.0 litre engines



15 Once the housing is empty, fit a new drain plug and O-ring. Tighten the drain plug and, if necessary, reconnect the hose union on the housing cover, making sure it is correctly engaged.

16 Move the container away and if necessary remove the hose. Wipe up any spillage and recover the rags.

17 Dispose of the drained fuel safely.

18 Prime the fuel system as described in Chapter 4C, then refit the engine cover.

## 5 Hose and fluid leak check



1 On 1.9 litre DW series engines, release the fasteners from the right-hand side and top of the engine cover then lift off the cover, taking care not to lose its mounting rubbers (see illustrations 4.6a to 4.6c). On 2.0 litre engines, release the fixings by turning them through 90°, and remove the engine cover (see illustrations 4.11a and 4.11b).

2 Visually inspect the engine joint faces, gaskets and seals for any signs of water or oil leaks. Pay particular attention to the areas around the camshaft cover, cylinder head, oil filter and sump joint faces. Bear in mind that, over a period of time, some very slight seepage from these areas is to be expected – what you are really looking for is any indication of a serious leak. Should a leak be found, renew the gasket or oil seal by referring to the appropriate Chapters in this manual.

3 Also check the security and condition of all the engine-related pipes and hoses. Ensure that all cable ties or securing clips are in place, and in good condition. Clips which are broken or missing can lead to chafing of the hoses, pipes or wiring, which could cause more serious problems in the future.

4 Carefully check the radiator hoses and heater hoses along their entire length. Renew any hose which is cracked, swollen or deteriorated. Cracks will show up better if the hose is squeezed. Pay close attention to the hose clips that secure the hoses to the cooling system components. Hose clips can

pinch and puncture hoses, resulting in cooling system leaks. If the original Peugeot/Citroën crimped-type hose clips are used, it may be a good idea to use worm-drive clips.

5 Inspect all the cooling system components (hoses, joint faces, etc) for leaks (see Haynes Hint).

6 Where any problems are found on system components, renew the component or gasket with reference to Chapter 3.

7 With the vehicle raised, inspect the fuel tank and filler neck for punctures, cracks and other damage. The connection between the filler neck and tank is especially critical. Sometimes a rubber filler neck or connecting hose will leak due to loose retaining clamps or deteriorated rubber.

8 Carefully check all rubber hoses and metal fuel lines leading away from the fuel tank. Check for loose connections, deteriorated hoses, crimped lines, and other damage. Pay particular attention to the vent pipes and hoses, which often loop up around the filler neck and can become blocked or crimped. Follow the lines to the front of the vehicle, carefully inspecting them all the way. Renew damaged sections as necessary.

9 From within the engine compartment, check the security of all fuel hose attachments and pipe unions, and inspect the fuel hoses and vacuum hoses for kinks, chafing and deterioration.

10 Where applicable, check the condition of the power steering fluid hoses and pipes.

11 On completion, refit the engine covers (where applicable).

## 6 Driveshaft gaiter check

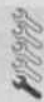

1 With the vehicle raised and securely supported on axle stands (see *Jacking and vehicle support*), turn the steering onto full lock, then slowly rotate the roadwheel. Inspect the condition of the outer constant velocity (CV) joint rubber gaiters, squeezing the gaiters to open out the folds (see illustration). Check for signs of cracking, splits or deterioration of the rubber, which may allow the grease to escape, and lead to

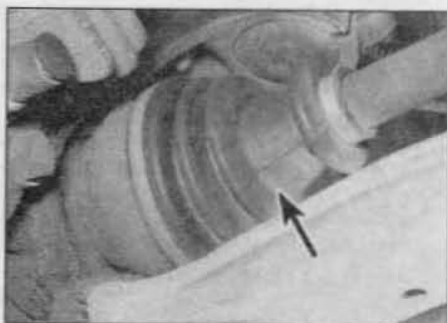

6.1 Check the condition of the driveshaft gaiters (arrowed)

water and grit entry into the joint. Also check the security and condition of the retaining clips. Repeat these checks on the inner CV joints. If any damage or deterioration is found, the gaiters should be renewed (see Chapter 8).

2 At the same time, check the general condition of the CV joints themselves by first holding the driveshaft and attempting to rotate the wheel. Repeat this check by holding the inner joint and attempting to rotate the driveshaft. Any appreciable movement indicates wear in the joints, wear in the driveshaft splines, or a loose driveshaft retaining nut.

## 7 Hinge and lock lubrication



1 Work around the vehicle, and lubricate the hinges of the bonnet, doors and tailgate with a general-purpose light oil.

2 Lightly lubricate the bonnet release mechanism and exposed section of inner cable with a smear of grease.

3 Check carefully the security and operation of all hinges, latches and locks, adjusting them where required. Check the operation of the central locking system (if fitted).

4 Check the condition and operation of the tailgate struts, renewing them if either is leaking or no longer able to support the tailgate securely when raised.

## 8 Road test



### Instruments and electrical equipment

1 Check the operation of all instruments and electrical equipment.

2 Make sure that all instruments read correctly, and switch on all electrical equipment in turn to check that it works properly.

### Steering and suspension

3 Check for any abnormalities in the steering, suspension, handling or road 'feel'.

4 Drive the vehicle, and check that there are no unusual vibrations or noises.

5 Check that the steering feels positive, with no excessive 'sloppiness', or roughness, and check for any suspension noises when cornering, or when driving over bumps.

### Drivetrain

6 Check the performance of the engine, clutch, transmission and driveshafts.

7 Listen for any unusual noises from the engine, clutch and transmission.

HAYNES  
HiNT



A leak in the cooling system will usually show up as white- or rust-coloured deposits on the area adjoining the leak.

8 Make sure that the engine runs smoothly when idling, and that there is no hesitation when accelerating.

9 Check that the clutch action is smooth and progressive, that the drive is taken up smoothly, and that the pedal travel is not excessive. Also listen for any noises when the clutch pedal is depressed.

10 Check that all gears can be engaged smoothly, without noise, and that the gear lever action is smooth and not abnormally vague or 'notchy'.

11 Listen for a metallic clicking sound from the front of the vehicle, as the vehicle is driven slowly in a circle with the steering on full lock. Carry out this check in both directions. If a clicking noise is heard, this indicates wear in a driveshaft joint, in which case, the complete driveshaft must be renewed (see Chapter 8).

### Braking system

12 Make sure that the vehicle does not pull to

one side when braking, and that the wheels do not lock prematurely when braking hard.

13 Check that there is no vibration through the steering when braking.

14 Check that the handbrake operates correctly, without excessive movement of the lever, and that it holds the vehicle stationary on a slope.

15 Test the operation of the brake servo unit as follows. With the engine off, depress the footbrake four or five times to exhaust the vacuum. Start the engine, holding the brake pedal depressed. As the engine starts, there should be a noticeable 'give' in the brake pedal as vacuum builds-up. Allow the engine to run for at least two minutes, and then switch it off. If the brake pedal is depressed now, it should be possible to detect a hiss from the servo as the pedal is depressed. After about four or five applications, no further hissing should be heard, and the pedal should feel considerably firmer.

### 9 Resetting the service indicator

1 On completion of the service, reset the service interval indicator as follows.

2 With the ignition switched off, press and hold the trip meter button.

3 Turn on the ignition switch, and the display begins a countdown. When the countdown reaches 0, release the trip meter button, and the spanner service symbol in the display will disappear.

4 Turn off the ignition switch.

5 Turn on the ignition switch and check the correct mileage to the next service interval is displayed on the indicator.

**Note:** If you need to disconnect the battery after carrying out this procedure, lock the vehicle and wait at least 5 minutes. Otherwise the display reset may not register.

## Every 10 000/12 000 miles (15 000/20 000km) or two years

1.8 and 1.9 litre engines – every 10 000 miles (15 000 km)

2.0 litre engines – every 12 000 miles (20 000 km)

### 10 Pollen filter renewal

1 Release the carpet trim panel from under the fascia on the passenger's side.

2 Remove the three securing screws, and

withdraw the lid from the pollen filter housing on the heater assembly. If no screws are visible, slide the lid sideways to release the internal retaining lugs.

3 Withdraw the pollen filter.

4 Clean the filter housing and the lid, then fit the new filter using a reversal of the removal procedure.

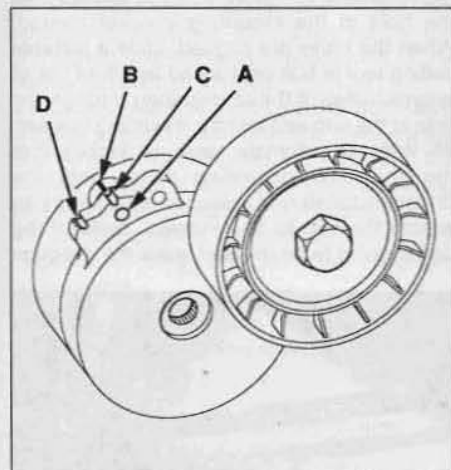

12.4 Auxiliary drivebelt automatic tensioner details

- A Tensioner arm locking pin hole
- B Backplate indicator mark and locking pin locating hole
- C Tensioner arm right-hand (zero) wear mark
- D Tensioner arm left-hand (maximum) wear mark

### 11 Idle speed and anti-stall speed check and adjustment – 1.8 and 1.9 litre engines

Refer to Chapter 4B, Section 9.

### 12 Auxiliary drivebelt check and renewal – 1.8 and 1.9 litre engines

**Note:** Peugeot/Citroën specify the use of a special electronic tool (SEEM C.TRONIC type 105 belt tensioning measuring tool) to correctly set the auxiliary drivebelt tension on manually-adjusted drivebelts. This is an involved process that varies significantly according to engine type, model year, and belt type and condition. The following procedure is an alternative method assuming that the electronic equipment is not being used. If any problems arise (such as screeching noises when driving) the tension should be checked by a Peugeot/Citroën dealer using the special electronic tool at the earliest opportunity.

### Check

1 Check the rear wheels then jack up the front of the vehicle and support it on axle stands (see *Jacking and vehicle support*). Remove the right-hand front roadwheel.

2 From underneath the front of the car, undo the screws, prise out the retaining clips, and remove the wheel arch liner to gain access to the crankshaft sprocket/pulley bolt. Where necessary, unclip the coolant hoses from the wing to improve access further.

3 Using a suitable socket and extension bar fitted to the crankshaft sprocket/pulley bolt, rotate the crankshaft so that the entire length of the drivebelt(s) can be examined. Examine the drivebelt(s) for cracks, splitting, fraying or damage. Check also for signs of glazing (shiny patches) and for separation of the belt plies. Renew the belt if worn or damaged.

4 On 1.9 litre DW series engines with power steering (but without air conditioning) which are equipped with an automatic belt tensioner, check the position of the wear indicators on the tensioner pulley arm and backplate (see illustration). The indicator mark on the backplate must be positioned between the two marks on the tensioner arm. If not, the belt is stretched and should be renewed.

5 If the condition of the belt is satisfactory, on models where the belt is adjusted manually, check the drivebelt tension as described below, bearing in mind the Note at the start of this Section. On models with an automatic spring-loaded tensioner, there is no need to check the drivebelt tension.



**XUD series engines with manual adjuster on alternator upper mounting**

**Removal**

6 If not already done, proceed as described in paragraphs 1 and 2.

7 Disconnect the battery negative terminal (refer to *Disconnecting the battery* in the Reference Chapter).

8 Slacken both the alternator upper and lower mounting nuts/bolts (as applicable) and the adjuster strap bolt.

9 Back off the adjuster bolt to relieve the tension in the drivebelt, then slip the drivebelt from the pulleys (see illustration). **Note:** If the belt is going to be re-used, mark the direction of rotation on the belt prior to removal. This will ensure it is refitted the correct way around.

**Refitting**

10 If the belt is being renewed, ensure that the correct type is used and if the original belt is being refitted, use the mark made on removal to ensure it is fitted the correct way around. Fit the belt around the pulleys, and take up the slack in the belt by tightening the adjuster bolt.

11 Tension the drivebelt as described in the following paragraphs.

**Tensioning**

**HAYNES HINT** Correct tensioning of the drivebelt will ensure that it has a long life. A belt which is too slack will slip and squeal. Beware, however, of over-tightening, as this can cause wear in the alternator bearings.

12 If not already done, proceed as described in paragraphs 1 and 2.

13 The belt should be tensioned so that, under firm thumb pressure, there is about 5.0 mm of free movement at the mid-point between the pulleys on the longest belt run (see the note at the start of this Section).

14 To adjust, with the mounting nut/bolts just holding the alternator firm, turn the adjuster bolt until the correct tension is achieved.

15 Rotate the crankshaft a couple of times,

recheck the tension, then securely tighten both the alternator mounting nuts/bolts. Where applicable, also tighten the bolt securing the adjuster strap to its mounting bracket.

16 Reconnect the battery negative terminal.

17 Clip the coolant hoses into position (where necessary), then refit the wheel arch liner. Refit the roadwheel, and lower the vehicle to the ground.

**XUD series engines with manually-adjusted tensioning pulley**

**Removal**

18 If not already done, proceed as described in paragraphs 1 and 2.

19 Disconnect the battery negative terminal (refer to *Disconnecting the battery* in the Reference Chapter).

20 Slacken the two bolts securing the tensioning pulley assembly to the engine (see illustration).

21 Rotate the adjuster bolt to move the tensioning pulley away from the drivebelt until there is sufficient slack for the drivebelt to be removed from the pulleys (see illustration).

**Note:** If the belt is going to be re-used, mark the direction of rotation on the belt prior to removal. This will ensure it is refitted the correct way around.

**Refitting**

22 If the belt is being renewed, ensure that the correct type is used and if the original belt is being refitted, use the mark made on removal to ensure it is fitted the correct way around. Fit the drivebelt around the pulleys ensuring that the ribs on the belt are correctly engaged with the pulley grooves, and that the drivebelt is correctly routed.

23 Take all the slack out of the belt by turning the tensioner pulley adjuster bolt, then tension the belt as follows.

**Tensioning**

24 If not already done, proceed as described in paragraphs 1 and 2.

25 Correct tensioning of the drivebelt will ensure that it has a long life – see Haynes Hint above.

26 The belt should be tensioned so that, under firm thumb pressure, there is approximately 5.0

mm of free movement at the mid-point between the pulleys on the longest belt run.

27 To adjust the tension, with the two tensioner pulley assembly retaining screws slackened, rotate the adjuster bolt until the correct tension is achieved. Once the belt is correctly tensioned, rotate the crankshaft a couple of times and recheck the tension.

28 When the belt is correctly tensioned, securely tighten the tensioner pulley assembly retaining screws, then reconnect the battery negative terminal.

29 Clip the coolant hoses into position, then refit the plastic cover to the wing valance. Refit the roadwheel, and lower the vehicle to the ground.

**XUD series engines with automatic spring-loaded tensioning pulley**

**Removal**

30 If not already done, proceed as described in paragraphs 1 and 2.

31 Disconnect the battery negative terminal (refer to *Disconnecting the battery* in the Reference Chapter).

32 Where necessary, remove the retaining screws from the power steering pump pulley shield, and remove the shield to gain access to the top of the drivebelt.

33 Working under the wheel arch, slacken the retaining bolt located in the centre of the eccentric tensioning pulley.

34 Insert a cranked 7.0 mm square section bar (a quarter inch square section drive socket bar for example) into the square hole on the front face of the eccentric tensioning pulley.

35 Using the bar, turn the eccentric tensioning pulley until the hole in the arm of the automatic tensioner pulley is aligned with the hole in the mounting bracket behind. When the holes are aligned, slide a suitable setting tool (a bolt or cranked length of bar of approximately 8.0 mm diameter) through the hole in the arm and into the mounting bracket.

36 With the automatic tensioner locked, turn the eccentric tensioning pulley until the drivebelt tension is released sufficiently to enable the belt to be removed. **Note:** If the belt is going to be re-used, mark the direction

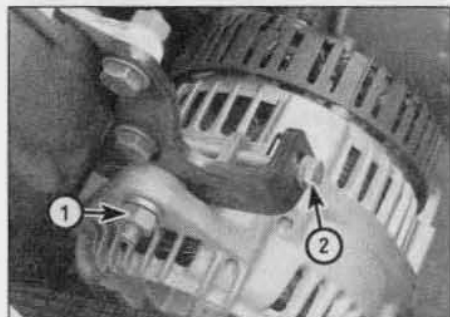

12.9 Alternator upper mounting nut (1) and adjuster bolt (2) – XUD series engines

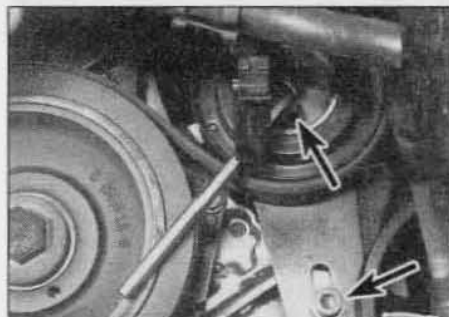

12.20 Slacken the two tensioner roller retaining screws (arrowed) . . .

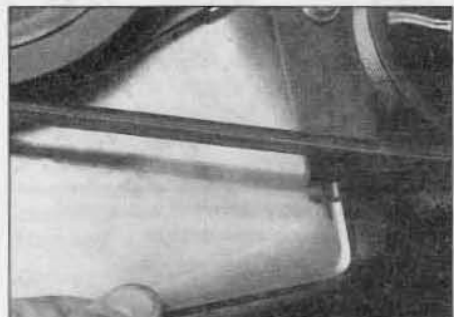

12.21 . . . then turn the tensioner roller adjuster bolt to release the belt tension – XUD series engines



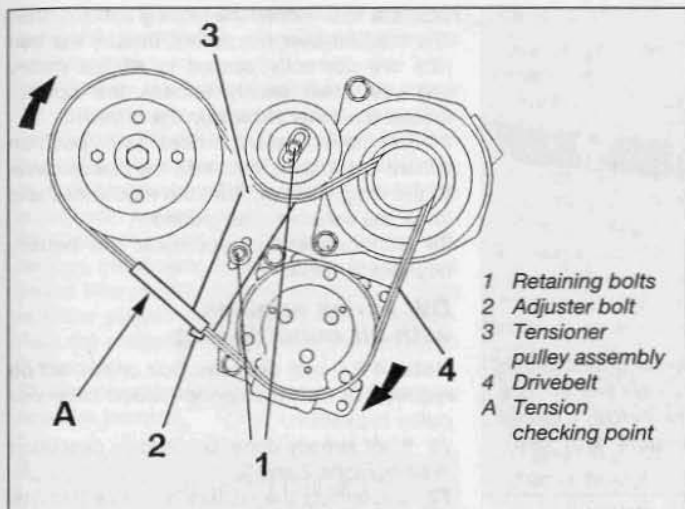

12.44 Auxiliary drivebelt and tensioner details – DW series engines without power steering

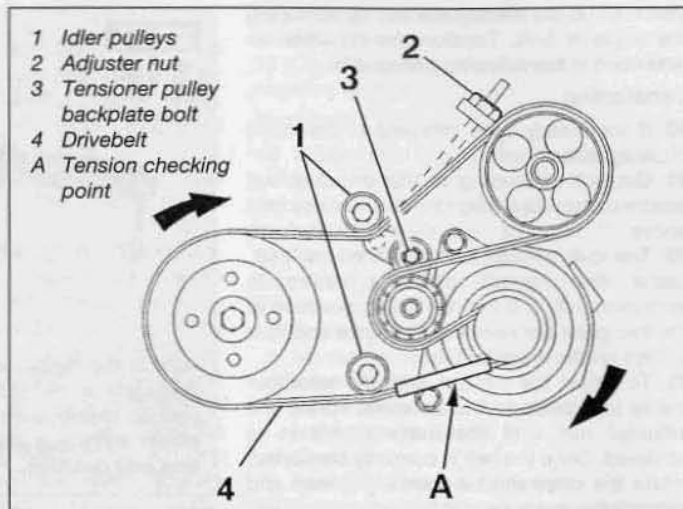

12.57 Auxiliary drivebelt and tensioner details – DW series engines with power steering and manual tensioner assembly

of rotation on the belt prior to removal. This will ensure it is refitted the correct way around.

### Refitting and tensioning

**37** If the belt is being renewed, ensure that the correct type is used and if the original belt is being refitted, use the mark made on removal to ensure it is fitted the correct way around. Fit the drivebelt around the pulleys ensuring that the ribs on the belt are correctly engaged with the pulley grooves, and that the drivebelt is correctly routed.

**38** Turn the eccentric tensioning pulley to apply tension to the drivebelt, until the load is released from the setting bolt. Without altering the position of the eccentric tensioning pulley, tighten its retaining bolt securely.

**39** Remove the setting bolt from the automatic tensioner arm, then rotate the crankshaft four complete revolutions in the normal direction of rotation.

**40** Check that the holes in the automatic adjuster arm and the mounting bracket are still aligned by re-inserting the setting bolt. If the bolt will not slide in easily, repeat the tensioning procedure from paragraph 38 onward.

**41** On completion, reconnect the battery negative terminal, and all other disturbed components.

### DW series engines without power steering

#### Removal

**42** If not already done, proceed as described in paragraphs 2 and 3.

**43** Disconnect the battery negative terminal (refer to *Disconnecting the battery* in the Reference Chapter).

**44** Slacken the two bolts securing the tensioner pulley assembly to the engine (see illustration).

**45** Rotate the adjuster bolt to move the tensioner pulley away from the drivebelt until there is sufficient slack for the drivebelt to be

removed from the pulleys. **Note:** If the belt is going to be re-used, mark the direction of rotation on the belt prior to removal. This will ensure it is refitted the correct way around.

#### Refitting

**46** If the belt is being renewed, ensure that the correct type is used and if the original belt is being refitted, use the mark made on removal to ensure it is fitted the correct way around.

**47** Fit the drivebelt around the pulleys ensuring that the ribs on the belt are correctly engaged with the pulley grooves, and that the drivebelt is correctly routed.

**48** Take all the slack out of the belt by turning the tensioner pulley adjuster bolt, then tension the belt as follows.

#### Tensioning

**HAYNES** **HiNT** Correct tensioning of the drivebelt will ensure that it has a long life. A belt which is too slack will slip and squeal. Beware, however, of over-tightening, as this can cause wear in the alternator bearings.

**49** If not already done, proceed as described in paragraphs 2 and 3.

**50** The belt should be tensioned so that, under firm thumb pressure, there is approximately 5.0 mm of free movement at the mid-point between the pulleys on the longest belt run.

**51** To adjust the tension, with the two tensioner pulley assembly retaining bolts slackened, rotate the adjuster bolt until the correct tension is achieved. Once the belt is correctly tensioned, rotate the crankshaft a couple of times and recheck the tension.

**52** When the belt is correctly tensioned, securely tighten the tensioner pulley assembly retaining bolts, then reconnect the battery negative terminal.

**53** Clip the coolant hoses into position (where applicable), then refit the plastic cover to the wing valance. Refit the roadwheel, and lower the vehicle to the ground.

### DW series engines with power steering (without air conditioning) with a manual tensioner

#### Removal

**54** If not already done, proceed as described in paragraphs 2 and 3.

**55** Disconnect the battery negative terminal (refer to *Disconnecting the battery* in the Reference Chapter).

**56** Release the fasteners from the right-hand side and top of the engine cover then lift off the cover, taking care not to lose its mounting rubbers (see illustrations 4.6a to 4.6c).

**57** Slacken the tensioner pulley backplate bolt and back off the pulley adjuster nut, located behind the power steering pump, to move the pulley away from the drivebelt (see illustration). Once there is sufficient slack in the drivebelt, slip the belt off the pulleys and remove it from the engine. **Note:** If the belt is going to be re-used, mark the direction of rotation on the belt prior to removal. This will ensure it is refitted the correct way around.

#### Refitting

**58** If the belt is being renewed, ensure that the correct type is used and if the original belt is being refitted, use the mark made on removal to ensure it is fitted the correct way around. Fit the belt around the pulleys in the following order:

- a) Power steering pump.
- b) Tensioner pulley.
- c) Alternator.
- d) Lower idler pulley.
- e) Crankshaft.
- f) Upper idler pulley.

**59** Ensure that the ribs on the belt are correctly engaged with the pulley grooves,

then take up the slack in the belt by tightening the adjuster bolt. Tension the drivebelt as described in the following paragraphs.

### Tensioning

**60** If not already done, proceed as described in paragraphs 2 and 3.

**61** Correct tensioning of the drivebelt will ensure that it has a long life – see Haynes Hint above.

**62** The belt should be tensioned so that, under firm thumb pressure, there is approximately 5.0 mm of free movement at the mid-point between the alternator and idler pulleys on the lower belt run.

**63** To adjust the tension, with the tensioner pulley backplate bolt slackened, rotate the adjuster nut until the correct tension is achieved. Once the belt is correctly tensioned, rotate the crankshaft a couple of times and recheck the tension.

**64** When the belt is correctly tensioned, securely tighten the tensioner pulley backplate bolt, then lightly tighten the adjuster nut.

**65** Clip the coolant hoses into position (where applicable), then refit the plastic cover to the wing valance. Refit the roadwheel, and lower the vehicle to the ground.

**66** Ensure that the mounting rubbers are all correctly fitted then install the engine cover, securing it in position with the fasteners.

**67** On completion, reconnect the battery negative terminal.

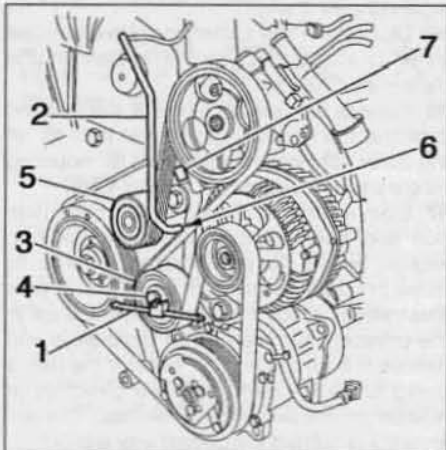

**12.79** Auxiliary drivebelt and tensioner details – DW series engines with air conditioning

- 1 Peugeot/Citroën tool for moving the manual tensioner pulley
- 2 Peugeot/Citroën locking pin for spring-loaded tensioner
- 3 Drivebelt
- 4 Manual tensioner pulley
- 5 Spring-loaded tensioner pulley
- 6 Spring-loaded tensioner pulley arm locking hole
- 7 Spring-loaded tensioner pulley arm square-section hole (only accessible with drivebelt removed)

### TOOL TIP



**Attach the tensioner locking bolt/pin to a length of metal bar. This will enable you to manoeuvre the bolt/pin easily down between the engine and body and into position.**

### DW series engines with power steering (without air conditioning) with an automatic tensioner

**Note:** A 4.0 mm diameter bolt or pin will be required to lock the spring-loaded tensioner pulley in position (see *Tool Tip*).

### Removal

**68** If not already done, proceed as described in paragraphs 2 and 3.

**69** Disconnect the battery negative terminal (refer to *Disconnecting the battery* in the Reference Chapter).

**70** Using a spanner/socket fitted to the spring-loaded tensioner pulley centre bolt, move the tensioner pulley away from the belt until it is possible to slip the drivebelt off one of the pulleys. Once the drivebelt has been displaced, align the tensioner arm right-hand (zero) wear mark (see *illustration 12.4*) with the backplate indicator mark and lock the tensioner in position by inserting the 4.0 mm diameter bolt/pin (see *illustrations 13.8a* and *13.8b*). Ensure the bolt/pin is correctly located in the backplate, then release the tensioner.

**71** Disengage the drivebelt from all the pulleys, noting its correct routing, and remove it from the engine. **Note:** If the belt is going to be re-used, mark the direction of rotation on the belt prior to removal. This will ensure it is refitted the correct way around.

### Refitting and tensioning

**72** If the belt is being renewed, ensure that the correct type is used and if the original belt is being refitted, use the mark made on removal to ensure it is fitted the correct way around. Fit the belt around the pulleys in the following order:

- a) Power steering pump.
- b) Upper idler pulley.
- c) Alternator.
- d) Lower idler pulley.
- e) Crankshaft.

**73** Fit the spanner/socket to the spring-loaded tensioner pulley bolt. Move the tensioner pulley away from the belt until it is

possible to withdraw the locking bolt/pin, then slip the belt over the pulley. Ensure the belt ribs are correctly seated in all the pulley grooves, then slowly release the spring-loaded tensioner to tension the drivebelt.

**74** Clip the coolant hoses into position (where applicable), then refit the plastic cover to the wing valance. Refit the roadwheel, and lower the vehicle to the ground.

**75** On completion, reconnect the battery negative terminal.

### DW series engines with air conditioning

**Note:** A 6.0 mm diameter bolt or pin will be required to lock the spring-loaded tensioner pulley in position.

**76** If not already done, proceed as described in paragraphs 2 and 3.

**77** Disconnect the battery negative terminal (refer to *Disconnecting the battery* in the Reference Chapter).

**78** Slacken the manual tensioner pulley bolt.

**79** Pivot the manual tensioner pulley in a clockwise direction, using a square-section key fitted to the hole in the pulley hub, to move the spring-loaded tensioner pulley. Position the tensioner pulley so that the hole in its arm aligns with the corresponding hole in the bracket, then lock the pulley in position by inserting the 6.0 mm diameter bolt/pin (see *illustration*). Ensure that the spring-loaded tensioner pulley is locked securely in position, then release the manual tensioner pulley.

**80** Disengage the drivebelt from all the pulleys, noting its correct routing, and remove it from the engine. **Note:** If the belt is going to be re-used, mark the direction of rotation on the belt prior to removal. This will ensure it is refitted the correct way around.

### Refitting and tensioning

**81** Ensure that the spring loaded tensioner pulley is locked in position (see paragraph 79).

**Note:** The pulley arm has a square-section cut-out to allow the pulley to be moved using a ratchet/bar, but this hole is only accessible with the drivebelt removed.

**82** If the belt is being renewed, ensure that the correct type is used and if the original belt is being refitted, use the mark made on removal to ensure it is fitted the correct way around. Fit the belt around the pulleys in the following order:

- a) Power steering pump.
- b) Manual tensioner pulley.
- c) Alternator.
- d) Air conditioning compressor.
- e) Crankshaft.
- f) Spring-loaded tensioner pulley.

**83** Ensure the belt ribs are correctly seated in all the pulley grooves, then rotate the manual tensioner pulley in a clockwise direction to remove all slack from the belt.

**84** To correctly set the drivebelt tension, position the manual tensioner pulley so that all spring pressure is removed from the locking bolt/pin fitted to the spring-loaded tensioner



arm. Once the manual tensioner pulley is correctly positioned, securely tighten its retaining bolt.

**85** Remove the locking bolt/pin then rotate the crankshaft through four complete revolutions. Check that the locking bolt/pin can still be easily inserted. If not, slacken the manual tensioner pulley bolt and repeat the adjustment procedure.

**86** Once the belt is correctly tensioned, remove the locking bolt/pin, clip the coolant hoses into position (where applicable), then refit the plastic cover to the wing valance. Refit the roadwheel, and lower the vehicle to the ground.

**87** On completion, reconnect the battery negative terminal.

### 13 Auxiliary drivebelt check and renewal – 2.0 litre engines



#### Check

**1** Chock the rear wheels then jack up the front of the vehicle and support it on axle stands (see *Jacking and vehicle support*). Remove the right-hand front roadwheel.

**2** From underneath the front of the car, undo the screws, prise out the retaining clips, and remove the wheel arch liner to gain access to the crankshaft sprocket/pulley bolt. Where necessary, unclip the coolant hoses from the wing to improve access further.

**3** Using a suitable socket and extension bar fitted to the crankshaft sprocket/pulley bolt, rotate the crankshaft so that the entire length of the drivebelt can be examined. Examine the drivebelt for cracks, splitting, fraying or damage. Check also for signs of glazing (shiny patches) and for separation of the belt plies. Renew the belt if worn or damaged.

**4** Check the position of the wear indicators on the tensioner pulley arm and backplate (see *illustration 12.4*). The indicator mark on the backplate must be positioned between the two marks on the tensioner arm. If not, the belt is stretched and should be renewed.

**5** If the condition of the belt is satisfactory, refit the wheel arch liner and roadwheel, then lower the vehicle to the ground.

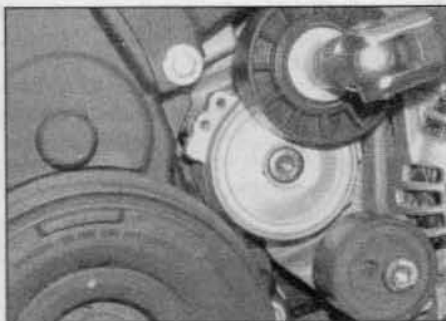

**13.8a** Using a spanner/socket on the tensioner pulley bolt, align the arm zero wear mark with the backplate indicator ...

#### Removal

**Note:** A 4.0 mm diameter bolt or pin will be required to lock the spring-loaded tensioner pulley in position (see *Tool Tip in Section 12*).

**6** If not already done, proceed as described in paragraphs 1 and 2.

**7** Disconnect the battery negative terminal (refer to *Disconnecting the battery* in the Reference Chapter).

**8** Using a spanner/socket fitted to the spring-loaded tensioner pulley centre bolt, move the tensioner pulley away from the belt until it is possible to slip the drivebelt off one of the pulleys. Once the drivebelt has been displaced, align the tensioner arm right-hand (zero) wear mark (see *illustration 12.4*) with the backplate indicator mark and lock the tensioner in position by inserting the 4.0 mm diameter bolt/pin (see *illustrations*). Ensure the bolt/pin is correctly located in the backplate, then release the tensioner.

**9** Disengage the drivebelt from all the pulleys, noting its correct routing, and remove it from the engine. **Note:** If the belt is going to be re-used, mark the direction of rotation on the belt prior to removal. This will ensure it is refitted the correct way around.

#### Refitting

##### Used belt

**10** If the original belt is being refitted, use the mark made on removal to ensure it is fitted the correct way around. Fit the belt around the pulleys in the following order:

- a) Power steering pump.
- b) Manual tensioner pulley.
- c) Alternator.
- d) Air conditioning compressor/lower idler pulley (as applicable).
- e) Crankshaft.

**11** Fit the spanner/socket to the spring-loaded tensioner pulley bolt. Move the tensioner pulley away from the belt until it is possible to withdraw the locking bolt/pin, then slip the belt over the pulley. Ensure the belt ribs are correctly seated in all the pulley grooves, then slowly release the spring-loaded tensioner to tension the drivebelt.

**12** Clip the coolant hoses into position (where applicable), then refit the wheel arch

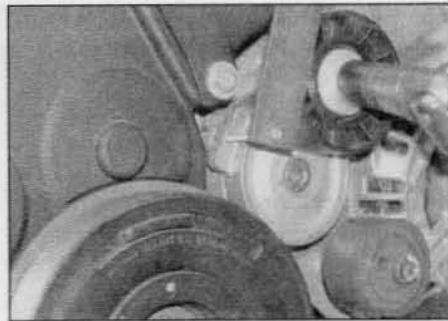

**13.8b** ... and lock it in position by inserting the bolt/pin through the arm and backplate holes – 2.0 litre engines

liner. Refit the roadwheel, and lower the vehicle to the ground.

**13** On completion, reconnect the battery negative terminal.

#### New belt

**14** Ensure that the spring loaded tensioner pulley is locked in position with its right-hand (zero) wear mark correctly aligned with the backplate indicator (see paragraph 8).

**15** Slacken the manual tensioner pulley bolt, then fit the new drivebelt around the pulleys in the following order:

- a) Power steering pump.
- b) Manual tensioner pulley.
- c) Alternator.
- d) Air conditioning compressor/lower idler pulley (as applicable).
- e) Crankshaft.
- f) Spring-loaded tensioner pulley.

**16** Ensure the belt ribs are correctly seated in all the pulley grooves, then rotate the manual tensioner pulley in a clockwise direction to remove all slack from the belt. Rotate the pulley using a square-section key fitted to the hole in the pulley hub.

**17** To correctly set the drivebelt tension, position the manual tensioner pulley so that all spring pressure is removed from the locking bolt/pin fitted to the spring-loaded tensioner pulley backplate (see *illustration*). Once the manual tensioner pulley is correctly positioned, securely tighten its retaining bolt.

**18** Remove the locking bolt/pin then rotate the crankshaft through four complete revolutions. Check that the holes in the tensioner pulley and backplate are still

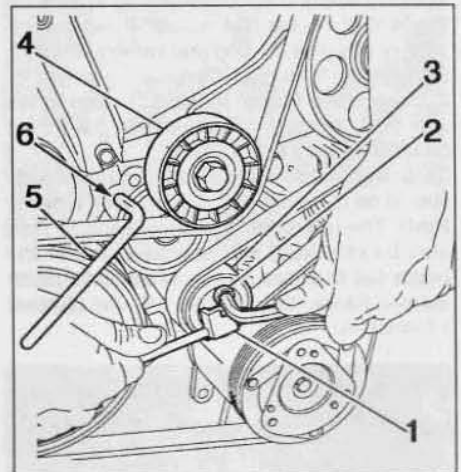

**13.17** Auxiliary drivebelt adjustment details – 2.0 litre engines

- 1 Peugeot/Citroën tool for moving the manual tensioner pulley
- 2 Manual tensioner pulley retaining bolt
- 3 Manual tensioner pulley
- 4 Spring loaded tensioner pulley
- 5 Peugeot/Citroën locking pin for spring-loaded tensioner
- 6 Spring-loaded tensioner pulley arm locking hole



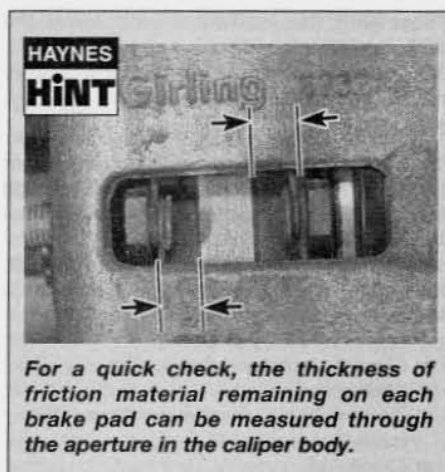

**For a quick check, the thickness of friction material remaining on each brake pad can be measured through the aperture in the caliper body.**

aligned, and that it is now possible to insert a setting tool of 2.0 mm diameter through both holes. If not, slacken the manual tensioner pulley bolt and repeat the adjustment procedure.

19 Once the belt is correctly tensioned, remove the setting tool, clip the coolant hoses into position (where applicable), then refit the wheel arch liner. Refit the roadwheel, and lower the vehicle to the ground.

20 On completion, reconnect the battery negative terminal.

#### 14 Front brake pad check

1 Firmly apply the handbrake, then jack up the front of the car and support it securely on axle stands (see *Jacking and vehicle support*). Remove the front roadwheels.

2 If any pad's friction material is worn to the specified thickness or less, *all four pads must be renewed as a set*.

3 For a comprehensive check, the brake pads should be removed and cleaned (see **Haynes Hint**). The operation of the caliper can then also be checked, and the condition of the brake disc itself can be fully examined on both sides. Refer to Chapter 9 for further information.



**18.4 Check for wear in the hub bearings by grasping the wheel and trying to rock it**

#### 15 Rear brake shoe check

1 Remove the rear brake drums, and check the brake shoes for wear or contamination. At the same time, also inspect the wheel cylinders for signs of leakage, and the brake drum for signs of wear. Refer to the relevant Sections of Chapter 9 for further information.

#### 16 Handbrake check and adjustment

Refer to Chapter 9.

#### 17 Exhaust system check

1 With the engine cold (at least an hour after the vehicle has been driven), check the complete exhaust system from the engine to the end of the tailpipe. The exhaust system is most easily checked with the vehicle raised on a hoist, or suitably-supported on axle stands, so that the exhaust components are readily visible and accessible (see *Jacking and vehicle support*).

2 Check the exhaust pipes and connections for evidence of leaks, severe corrosion and damage. Make sure that all brackets and mountings are in good condition, and that all relevant nuts and bolts are tight. Leakage at any of the joints or in other parts of the system will usually show up as a black sooty stain in the vicinity of the leak.

3 Rattles and other noises can often be traced to the exhaust system, especially the brackets and mountings. Try to move the pipes and silencers. If the components are able to come into contact with the body or suspension parts, secure the system with new mountings. Otherwise separate the joints (if possible) and twist the pipes as necessary to provide additional clearance.

#### 18 Steering and suspension check

##### Front suspension and steering

1 Raise the front of the vehicle, and securely support it on axle stands (see *Jacking and vehicle support*).

2 Inspect the balljoint dust covers and the steering rack-and-pinion gaiters for splits, chafing or damage. Any wear of these parts will cause loss of lubricant, together with dirt

and water entry, resulting in rapid deterioration of the balljoints or steering gear.

3 On models with power steering, check the fluid hoses for chafing or damage, and the pipe and hose unions for leaks. Also check for signs of leakage under pressure from the steering gear rubber gaiters, which would indicate failed fluid seals within the steering gear.

4 Grasp the roadwheel at the 12 o'clock and 6 o'clock positions, and try to rock it (see **illustration**). Very slight free play may be felt, but if the movement is appreciable, further investigation is necessary to determine the source. Continue rocking the wheel while an assistant depresses the footbrake. If the movement is now eliminated or significantly reduced, it is likely that the hub bearings are at fault. If the free play is still evident with the footbrake depressed, then there is wear in the suspension joints or mountings.

5 Now grasp the wheel at the 9 o'clock and 3 o'clock positions, and try to rock it as before. Any movement felt now may again be caused by wear in the hub bearings or the steering track rod balljoints. If the inner or outer balljoint is worn, the movement will be obvious.

6 Using a large screwdriver or flat bar, check for wear in the suspension mounting bushes by levering between the relevant suspension component and its attachment point. Some movement is to be expected as the mountings are made of rubber, but excessive wear should be obvious. Also check the condition of any visible rubber bushes, looking for splits, cracks or contamination of the rubber.

7 With the car standing on its wheels, have an assistant turn the steering wheel back-and-forth about an eighth of a turn each way. There should be very little, if any, lost movement between the steering wheel and roadwheels. If this is not the case, closely observe the joints and mountings previously described, but in addition, check the steering column universal joints for wear, and the steering gear itself.

##### Strut/shock absorbers

8 Check for any signs of fluid leakage around the suspension strut/shock absorber body, or from the rubber gaiter around the piston rod. Should any fluid be noticed, the suspension strut/shock absorber is defective internally, and should be renewed.

**Note:** *Suspension struts/shock absorbers should always be renewed in pairs on the same axle.*

9 The efficiency of the suspension strut/shock absorber may be checked by bouncing the vehicle at each corner. Generally speaking, the body will return to its normal position and stop after being depressed. If it rises and returns on a rebound, the suspension strut/shock absorber is probably suspect. Examine also the suspension strut/shock absorber upper and lower mountings for any signs of wear.

**Every 30 000/36 000 miles (45 000/60 000 km) or four years**

**1.8 and 1.9 litre engines – every 30 000 miles (45 000 km)**

**2.0 litre engines – every 36 000 miles (60 000 km)**

**9 Fuel filter renewal**



**Caution:** Take care not to allow dirt into the fuel filter housing during this procedure or to spill fuel onto the clutch assembly

**1.8 and 1.9 litre XUD series engines**

- 1 The fuel filter is located in a plastic housing at the front of the engine.
- 2 Where applicable, cover the clutch bellhousing with a piece of plastic sheeting, to protect the clutch from fuel spillage.
- 3 Remove all traces of dirt from the exterior of the filter housing then drain the fuel filter as described in Section 4.
- 4 Undo the four retaining bolts and lift off the filter housing cover (see illustration).
- 5 Lift the filter from the housing (see illustration). Ensure that the rubber sealing ring comes away with the filter, and does not stick to the housing/lid.
- 6 Remove all traces of dirt or debris from inside the filter housing then, making sure its sealing ring is in position, fit the new fuel filter.
- 7 Coat the threads of the filter cover securing bolts with thread-locking compound, then refit the cover and secure with the bolts.
- 8 Prime the fuel system as described in Chapter 4B.

**1.9 litre DW series engines**

- 9 Release the fasteners from the right-hand side and top of the engine cover then lift off the cover, taking care not to lose its mounting rubbers (see illustrations 4.6a to 4.6c).
- 10 Remove all traces of dirt from the exterior of the filter housing then drain the fuel filter as described in Section 4.
- 11 Release the retaining clip and detach the

fuel outlet pipe from the filter housing cover (see illustration).

- 12 Unclip the filter housing cover retaining clip then position the cover clear of the housing (see illustration). Discard the cover sealing ring – a new ring must be used on refitting.
- 13 Lift the fuel filter and sealing ring out of the housing (see illustration).
- 14 Remove all traces of dirt or debris from inside the filter housing.
- 15 Ensure that the housing and cover are spotlessly clean then fit the new fuel filter.

16 Ensure that the new small sealing ring is correctly fitted to the top of the filter, then fit the new large sealing ring to the cover (see illustrations).

- 17 Locate the cover correctly on the filter housing and refit the retaining clip. Ensure that the clip is correctly engaged with the housing and cover and secure it firmly in position.
- 18 Reconnect the fuel outlet pipe to the cover.
- 19 Check that the filter housing drain plug is



19.4 Lift off the fuel filter cover . . .



19.5 . . . then lift the filter from the housing – XUD series engines



19.11 Release the retaining clip and detach the fuel outlet pipe from the filter housing cover – 1.9 litre DW series engines



19.12 Release the clip and lift off the filter housing cover – 1.9 litre DW series engines



19.13 Lift the fuel filter and sealing ring out of the housing – 1.9 litre DW series engines



19.16a Ensure that the new small sealing ring (arrowed) is correctly fitted to the fuel filter . . .



19.16b . . . and the new large sealing ring (arrowed) is correctly fitted to the housing cover – 1.9 litre DW series engines



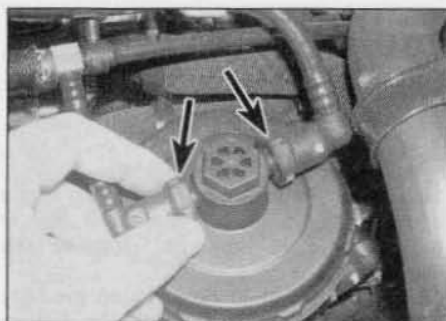

**19.24** Disconnect the fuel supply and return hose quick-release fittings (arrowed) from the filter housing cover – early 2.0 litre engines



**19.26a** Lift off the filter housing cover . . .



**19.26b** . . . remove the metal sealing ring . . .



**19.26c** . . . and the O-ring seal . . .



**19.26d** . . . then lift out the filter element – early 2.0 litre engines

securely closed, then prime the fuel system as described in Chapter 4C.

**20** Once the engine is idling smoothly, ensure that the mounting rubbers are all correctly fitted then install the engine cover, securing it in position with the fasteners.

### 2.0 litre engines

**Note:** Check with your dealer for the availability of fuel filter/housing before removal. On some models the fuel filter/housing may come as a complete assembly.

**Caution:** The need for scrupulous cleanliness when working on the fuel system of HDi engines cannot be over-emphasised. It is particularly important to keep foreign matter – dust, water or any other contaminant – out of the fuel lines. Bear in mind also, the following specific points:

- When renewing the fuel filter element, the filter housing must be cleaned in a solvent bath using injector test fluid, paraffin or similar. DO NOT use compressed air or ordinary rags to dry it off; special Resistel cleaning cloths, available from Peugeot/Citroën dealers, are the only items approved for this purpose.

- Before undertaking any work on the high pressure side of the system, remove any loose debris with a vacuum cleaner, then clean around the components to be removed with a paint brush and an approved solvent (Sodimac No 35, Mecanet or equivalent).

- DO NOT clean the engine using a steam cleaner or a high pressure water jet; use one of the solvents mentioned above.

- After disconnection of any fuel union, cover the open ends immediately to keep dirt out. Special plugs for this purpose can be obtained from your dealer.

**21** Two different filter assemblies may be encountered and can be identified by the design of the filter housing cover. On early engines the housing cover has a hexagonal moulding to enable it to be unscrewed using a suitable socket. On later engines the filter

housing cover is secured by a ribbed locking ring which can be unscrewed using a strap wrench. Identify the type of filter fitted and proceed as described under the relevant sub-heading.

### Early models

**22** Release the fixings by turning them through 90°, and remove the engine cover (see illustrations 4.11a and 4.11b).

**23** Remove all traces of dirt from the exterior of the filter housing then drain the fuel filter as described in Section 4.

**24** At the connections on the filter housing cover, disconnect the fuel supply and return hose quick-release fittings using a small screwdriver to release the locking clip (see illustration). Suitably plug or cover the open hose unions to prevent dirt entry.

**25** Using a suitable socket engaged with the hexagonal moulding on the filter housing cover, turn the cover approximately a quarter turn anti-clockwise to release the locking lugs.

**26** Lift off the housing cover, and collect the metal sealing ring and the O-ring seal, then lift out the filter element (see illustrations).

**27** Undo the two bolts and remove the filter housing from its mounting bracket. Thoroughly clean the filter housing and cover, bearing in mind the information on cleanliness given above. When the cleaning operations are complete, refit the housing to its mounting bracket and secure with the two retaining bolts.

**28** Fit the new fuel filter element to the housing.

**29** Lubricate the new O-ring with clean diesel

fuel and locate the seal in position, followed by the metal sealing ring.

**30** Refit the housing cover and turn it clockwise until the arrow on the housing cover is in line with the filter drain outlet.

**31** Reconnect the fuel supply and return hoses, then prime the fuel system as described in Chapter 4C.

**32** On completion, refit the engine cover.

### Later models

**33** Release the fixings by turning them through 90°, and remove the engine cover (see illustrations 4.11a and 4.11b).

**34** Remove all traces of dirt from the exterior of the filter housing then drain the fuel filter as described in Section 4.

**35** Where applicable, disconnect the wiring connector from the top of the filter housing cover (see illustration).



**19.35** Disconnect the wiring connector from the top of the filter housing cover – later 2.0 litre engines



36 Disconnect the fuel lines from the top of the fuel filter housing by releasing the quick-release fittings using a small screwdriver (see illustration). Move them to one side, covering the ends of the fuel lines to prevent dirt entry.

37 Using a strap wrench or similar tool, unscrew the locking ring from the filter housing. Lift off the housing cover then remove the filter element and the O-ring seal (see illustration). **Note:** Although in theory the locking ring on the filter housing unscrews, in practice we have found it impossible to unscrew the locking ring without damaging the housing, necessitating the renewal of the complete filter housing.

38 Undo the two bolts and remove the filter housing from its mounting bracket. Thoroughly clean the filter housing and cover, bearing in mind the information on cleanliness given above. When the cleaning operations are complete, refit the housing to its mounting bracket and secure with the two retaining bolts.

39 Fit the new fuel filter element to the housing.

40 Lubricate the new O-ring with clean diesel fuel and locate the seal in position on the housing.

41 Refit the housing cover and position it so the fuel inlet and outlet unions are parallel with the engine.

42 Screw the locking ring onto the housing and tighten it until the notches on the ring and housing are aligned.

43 Reconnect the fuel supply and return hoses and, where applicable, the wiring connector. Prime the fuel system as described in Chapter 4C.

44 On completion, refit the engine cover.

## 20 Air cleaner filter element renewal

### 1.8 and 1.9 litre XUD series engines

1 Slacken the retaining clip and disconnect the intake duct from the top of the filter housing. Slacken the retaining clips, and



20.3 ... and withdraw the filter element – XUD series engines

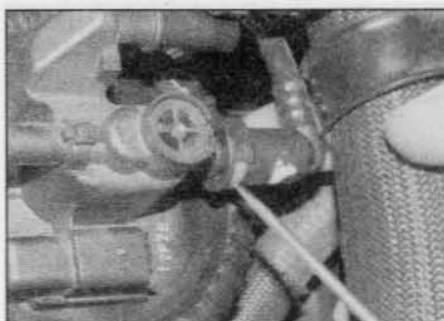

19.36 Disconnect the fuel supply and return hose quick-release fittings – later 2.0 litre engines

remove the duct linking the intake to the rear of the filter housing.

2 Release the retaining clips, then lift off the filter housing lid (see illustrations).

3 Remove the filter element from the housing (see illustration).

4 Wipe clean the inside of the filter housing and fit the new filter element, making sure that it is correctly seated.

5 Refit the lid, and secure it in position with the retaining clips.

6 Reconnect the intake ducts, securing them in position with the retaining clips.

### 1.9 litre DW series engines

#### WJZ engine models

7 Proceed as described above for XUD series engines.

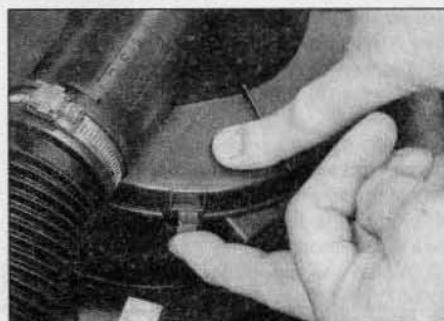

20.2a Release the clips securing the filter housing lid ...

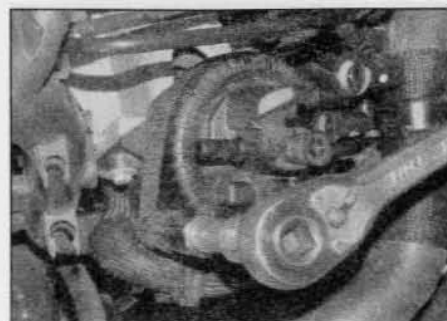

19.37 Using a strap wrench or similar, unscrew the locking ring from the filter housing – later 2.0 litre engines

### WJY engine models – pre-September 2002

8 Access to the filter element is obtained from under the front of the vehicle. If necessary, to improve access, firmly apply the handbrake then jack up the front of the vehicle and support it on axle stands (see *Jacking and vehicle support*).

9 Release the retaining clips, and remove the cover from the base of the air filter housing (see illustration).

10 Withdraw the filter element from the housing (see illustration).

11 Wipe clean the inside of the filter housing, then fit the new filter.

12 Refit the cover to the base of the housing, and secure it in position with the retaining clips. Where necessary, lower the vehicle to the ground.

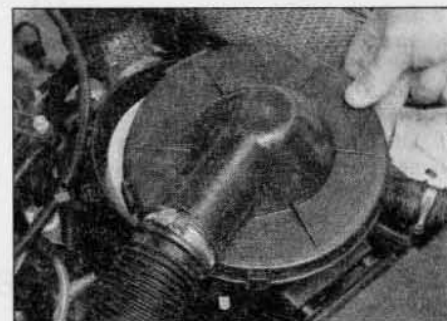

20.2b ... then lift off the lid ...



20.9 Release the retaining clips, and remove the cover from the base of the air cleaner filter housing – early DW series engines



20.10 Withdraw the filter element from the housing – early DW series engines



20.13 Disconnect the wiring connector from the airflow meter – later DW series engines

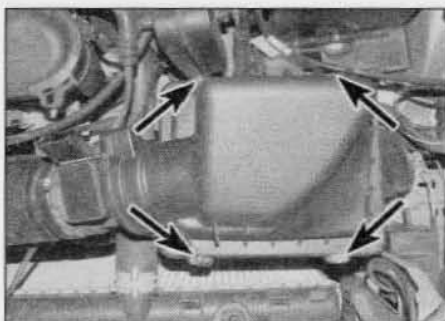

20.14 Undo the screws securing the lid to the air filter housing – later DW series engines



20.15 Lift up the lid and withdraw the filter element – later DW series engines



20.19 Disconnect the wiring connector from the airflow meter – 2.0 litre engines



20.20 Slacken the retaining clip and disconnect the air inlet duct from the airflow meter – 2.0 litre engines



20.21a Undo the two screws securing the lid to the air cleaner housing . . .

#### WJY engine models – post-September 2002

13 Disconnect the wiring connector from the airflow meter, mounted on the side of the air cleaner lid (see illustration).

14 Undo the screws securing the lid to the air filter housing (see illustration).

15 Lift up the lid and withdraw the filter element from the housing (see illustration).

16 Wipe clean the inside of the filter housing, then fit the new filter element making sure that it is correctly seated.

17 Refit the lid to the filter housing and secure with the retaining screws.

18 Reconnect the airflow meter wiring connector.

#### 2.0 litre engines

19 Disconnect the wiring connector from the airflow meter, located on the air cleaner lid (see illustration).

20 Slacken the retaining clip and disconnect the air inlet duct from the airflow meter (see illustration).

21 Undo the two screws securing the lid to the air cleaner housing. Lift up the right-hand side of the lid and disengage the two left-hand retaining lugs from the air cleaner housing (see illustrations).

22 Withdraw the filter element from the housing (see illustration).

23 Wipe clean the inside of the filter housing, then fit the new filter element making sure that it is correctly seated.

24 Refit the lid to the filter housing and secure with the retaining screws.

25 Reconnect the air inlet duct to the airflow meter, then reconnect the wiring connector.

#### 21 Manual transmission oil level check



**Note:** A suitable square-section wrench may be required to undo the transmission filler/level plug on some models. These wrenches can be obtained from most motor factors or your Peugeot/Citroën dealer.

1 Park the car on a level surface. The oil level must be checked before the car is driven, or at least 5 minutes after the engine has been switched off. If the oil is checked immediately after driving the car, some of the oil will remain distributed around the transmission, resulting in an inaccurate level reading.

2 Prise out the clips and remove the access cover from the left-hand wheel arch liner.

3 Wipe clean the area around the filler/level plug, which is on the left-hand end of the transmission (see illustration). Unscrew the plug and clean it; discard the sealing washer.

4 The oil level should reach the lower edge of the filler/level hole. A certain amount of oil will have gathered behind the filler/level plug, and will trickle out when it is removed; this does not necessarily indicate that the level is correct. To ensure that a true level is



20.21b . . . lift up the lid and disengage the two retaining lugs from the air cleaner housing – 2.0 litre engines



20.22 Withdraw the filter element from the housing – 2.0 litre engines



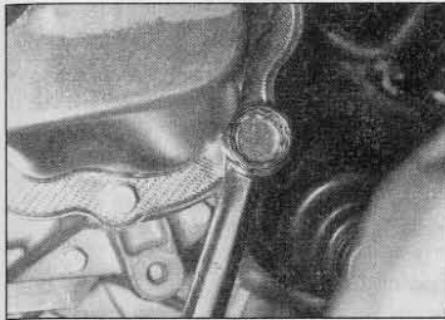

21.3 Removing the manual transmission filler/level plug

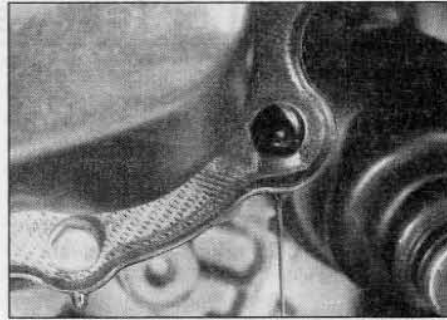

21.4 Oil level is correct when the oil stops flowing out of the filler/level hole

plug is removed, check that the car is completely level (front-to-rear and side-to-side), and allow the surplus to drain off into a suitable container.

7 When the level is correct, fit a new sealing washer to the filler/level plug. Refit the plug, tightening it to the specified torque wrench setting. Wash off any spilt oil then refit the access cover securing it in position with the retaining clips.

established, wait until the initial trickle has stopped, then add oil as necessary until a trickle of new oil can be seen emerging (see illustration). The level will be correct when the flow ceases; use only good-quality oil of the specified type (refer to *Lubricants and fluids*).  
5 Filling the transmission with oil is an extremely awkward operation; above all, allow plenty of time for the oil level to settle properly

before checking it. If a large amount is added to the transmission, and a large amount flows out on checking the level, refit the filler/level plug and take the vehicle on a short journey so that the new oil is distributed fully around the transmission components, then recheck the level when it has settled again.

6 If the transmission has been overfilled so that oil flows out as soon as the filler/level

## 22 Emissions control systems check



1 Details of the emissions control system components are given in Chapter 4D.

2 Checking consists simply of a visual check for obvious signs of damaged or leaking hoses and joints.

3 Detailed checking and testing of the evaporative and/or exhaust emissions systems (as applicable) should be entrusted to a Peugeot/Citroën dealer.

## Every 40 000/48 000 miles (60 000/80 000 km)

1.8 and 1.9 litre engines – every 40 000 miles (60 000 km)

2.0 litre engines – every 48 000 miles (80 000 km)

### 23 Timing belt renewal

Refer to the relevant Part of Chapter 2.

## Every 40 000 miles (60 000 km) or two years

### 24 Brake fluid renewal



**Warning: Brake hydraulic fluid can harm your eyes and damage painted surfaces, so use extreme caution when handling and pouring it. Do not use fluid that has been standing open for some time, as it absorbs moisture from the air. Excess moisture can cause a dangerous loss of braking effectiveness.**

1 The procedure is similar to that for the bleeding of the hydraulic system as described in Chapter 9, except that the brake fluid reservoir should be emptied

by syphoning, using a clean poultry baster or similar before starting, and allowance should be made for the old fluid to be expelled when bleeding a section of the circuit.

2 Working as described in Chapter 9, open the first bleed screw in the sequence, and pump the brake pedal gently until nearly all the old fluid has been emptied from the master cylinder reservoir.

3 Top-up to the MAX level with new fluid, and continue pumping until only the new fluid remains in the reservoir, and new fluid can be seen emerging from the bleed screw. Tighten the screw, and top the reservoir level up to the MAX level line.

4 Work through all the remaining bleed screws in the sequence until new fluid can be



**Old hydraulic fluid is invariably much darker in colour than the new, making it easy to distinguish the two.**

seen at all of them. Be careful to keep the master cylinder reservoir topped-up to above the MIN level at all times, or air may enter the system and greatly increase the length of the task.

5 When the operation is complete, check that all bleed screws are securely tightened, and that their dust caps are refitted. Wash off all traces of spilt fluid, and recheck the master cylinder reservoir fluid level.

6 Check the operation of the brakes before taking the car on the road.



## Every 40 000 miles (60 000 km) or four years

## 25 Coolant renewal



## Cooling system draining



**Warning:** Wait until the engine is cold before starting this procedure. Do not allow antifreeze to come in contact with

your skin, or with the painted surfaces of the vehicle. Rinse off spills immediately with plenty of water. Never leave antifreeze lying around in an open container, or in a puddle in the driveway or on the garage floor. Children and pets are attracted by its sweet smell, but antifreeze can be fatal if ingested.

1 On 1.9 litre DW series engines, release the fasteners from the right-hand side and top of the engine cover then lift off the cover, taking care not to lose its mounting rubbers (see illustrations 4.6a to 4.6c). On 2.0 litre engines, release the fixings by turning them through 90°, and remove the engine cover (see illustrations 4.11a and 4.11b).

2 With the engine completely cold, remove the expansion tank filler cap. Turn the cap anti-clockwise until it reaches the first stop. Wait until any pressure remaining in the system is released, then push the cap down, turn it anti-clockwise to the second stop, and lift it off.

3 Position a suitable container beneath the lower left-hand side of the radiator. On early models, loosen the drain plug (there is no need to remove it completely) and allow the coolant to drain into the container. On later models a drain plug is not provided, so it will be necessary to disconnect the radiator bottom hose to allow the coolant to drain.

4 To assist draining, open the cooling system bleed screws. These are located in the heater

matrix outlet hose union (to improve access, it may be located in an extension hose), on the engine compartment bulkhead and, on 2.0 litre engines, on the top of the thermostat housing (see illustrations).

5 When the flow of coolant stops, reposition the container below the cylinder block drain plug. The drain plug is located at the rear of the cylinder block.

6 Remove the drain plug, and allow the coolant to drain into the container.

7 If the coolant has been drained for a reason other than renewal, then provided it is clean and less than two years old, it can be re-used, though this is not recommended.

8 Refit the radiator and cylinder block drain plugs on completion of draining. Also refit the radiator bottom hose (later models) if the system is not to be flushed.

## Cooling system flushing

9 If coolant renewal has been neglected, or if the antifreeze mixture has become diluted, then in time, the cooling system may gradually lose efficiency, as the coolant passages become restricted due to rust, scale deposits, and other sediment. The cooling system efficiency can be restored by flushing the system clean.

10 The radiator should be flushed independently of the engine, to avoid unnecessary contamination.

## Radiator flushing

11 To flush the radiator, first tighten the radiator drain plug, and the radiator bleed screw, where applicable.

12 Disconnect the top and bottom hoses and any other relevant hoses from the radiator, with reference to Chapter 3.

13 Insert a garden hose into the radiator top inlet. Direct a flow of clean water through the radiator, and keep flushing until clean water emerges from the radiator bottom outlet.

14 If after a reasonable period, the water still does not run clear, the radiator can be flushed with a good proprietary cleaning agent. It is important that their manufacturer's instructions are followed carefully. If the contamination is particularly bad, insert the hose in the radiator bottom outlet, and reverse-flush the radiator.

## Engine flushing

15 To flush the engine, first refit the cylinder block drain plug, and tighten the cooling system bleed screws.

16 Remove the thermostat as described in Chapter 3, then temporarily refit the thermostat cover.

17 With the top and bottom hoses disconnected from the radiator, insert a garden hose into the radiator top hose. Direct a clean flow of water through the engine, and continue flushing until clean water emerges from the radiator bottom hose.

18 On completion of flushing, refit the thermostat and reconnect the hoses with reference to Chapter 3.

## Cooling system filling

19 Before attempting to fill the cooling system, make sure that all hoses and clips are in good condition, and that the clips are tight. An antifreeze mixture must be used all year round, to prevent corrosion of the engine components (see following sub-Section). Also check that the radiator and cylinder block drain plugs are in place and tight.

20 Remove the expansion tank filler cap.

21 Open all the cooling system bleed screws (see paragraph 4).

22 Some of the cooling system hoses are positioned at a higher level than the top of the radiator expansion tank. It is therefore necessary to use a 'header tank' when refilling the cooling system, to reduce the possibility of air being trapped in the system. Although



25.4a Heater hose bleed screw (arrowed)

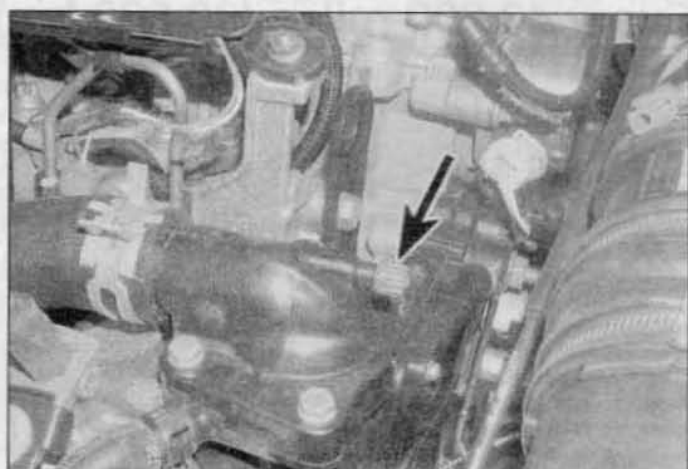

25.4b Thermostat housing bleed screw (arrowed)

**HAYNES  
HiNT**

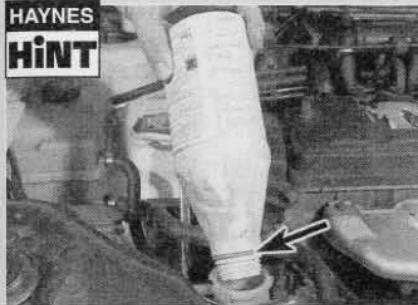

**Cut the bottom off an old antifreeze container to make a 'header tank' for use when refilling the cooling system. The seal at the point arrowed should be as airtight as possible – use an O-ring if available, or seal the joint by some other means.**

Peugeot/Citroën dealers use a special header tank, the same effect can be achieved by using a suitable bottle, with a seal between the bottle and the expansion tank (see **Haynes Hint**).

**23** Fit the 'header tank' to the expansion tank and slowly fill the system. Coolant will emerge

from each of the bleed screws in turn, starting with the lowest screw. As soon as coolant free from air bubbles emerges from the lowest screw, tighten that screw and, where applicable, watch the next bleed screw in the system. Repeat the procedure until the coolant is emerging from the highest bleed screw in the cooling system and all bleed screws are securely tightened.

**24** Continue to fill the cooling system until bubbles stop appearing in the expansion tank. Help to bleed the air from the system by repeatedly squeezing the radiator bottom hose.

**25** Ensure that the 'header tank' is full (at least 0.5 litres of coolant). Start the engine, and run it at a fast idle speed (do not exceed 2000 rpm) until the cooling fan cuts in, and then cuts out. Stop the engine. **Note:** Take great care not to scald yourself with the hot coolant during this operation.

**26** Allow the engine to cool, then remove the 'header tank'.

**27** When the engine has cooled, check the coolant level as described in *Weekly checks*. Top-up the level if necessary, and refit the expansion tank cap. Refit the engine cover (where applicable).

### **Antifreeze mixture**

**28** The antifreeze should always be renewed at the specified intervals. This is necessary not only to maintain the antifreeze properties, but also to prevent corrosion which would otherwise occur as the corrosion inhibitors become progressively less effective.

**29** Always use an ethylene-glycol based antifreeze of the specified type (see *Lubricants and fluids*). The quantity of antifreeze and level of protection are indicated in the Specifications.

**30** Before adding antifreeze, the cooling system should be completely drained, preferably flushed, and all hoses checked for condition and security.

**31** After filling with antifreeze, a label should be attached to the expansion tank, stating the type and concentration of antifreeze used, and the date installed. Any subsequent topping-up should be made with the same type and concentration of antifreeze.

**32** Do not use engine antifreeze in the windscreen/tailgate washer system, as it will cause damage to the vehicle paintwork. A screenwash additive should be added to the washer system in the quantities stated on the bottle.

## Every ten years

### **26 Airbags and seat belt pretensioners renewal**



**1** Peugeot/Citroën recommend that the airbags and seat belt pretensioners are renewed regardless of their condition every ten years. Refer to Chapter 12 for airbag renewal, and Chapter 11 for seat belt pretensioner renewal.

Every ten years... The first ten years of a child's life are crucial for development. During this period, the brain undergoes rapid growth and maturation. The first three years are particularly important, as they lay the foundation for all future learning and behavior. Children who experience neglect or abuse during this time may have long-term effects on their cognitive and emotional well-being.

Every ten years... The second ten years of a child's life are also critical. This period is characterized by continued brain development and the emergence of more complex cognitive and social skills. Children who experience trauma or neglect during this time may have difficulties with learning and social interaction later in life.



Figure 1: A large, dark, rectangular area, possibly a scan artifact or a very dark photograph.

Every ten years... The third ten years of a child's life are also critical. This period is characterized by continued brain development and the emergence of more complex cognitive and social skills. Children who experience trauma or neglect during this time may have difficulties with learning and social interaction later in life.

Every ten years... The fourth ten years of a child's life are also critical. This period is characterized by continued brain development and the emergence of more complex cognitive and social skills. Children who experience trauma or neglect during this time may have difficulties with learning and social interaction later in life.



Figure 2: A large, dark, rectangular area, possibly a scan artifact or a very dark photograph.

Every ten years... The fifth ten years of a child's life are also critical. This period is characterized by continued brain development and the emergence of more complex cognitive and social skills. Children who experience trauma or neglect during this time may have difficulties with learning and social interaction later in life.

Every ten years... The sixth ten years of a child's life are also critical. This period is characterized by continued brain development and the emergence of more complex cognitive and social skills. Children who experience trauma or neglect during this time may have difficulties with learning and social interaction later in life.



Figure 3: A large, dark, rectangular area, possibly a scan artifact or a very dark photograph.



# Chapter 2 Part A:

## Petrol engine in-car repair procedures

### Contents

	Section number		Section number
Camshaft(s) and rocker arms/followers – removal, inspection and refitting	10	Engine/transmission mountings – inspection and renewal	16
Camshaft oil seal(s) – renewal	8	Flywheel – removal, inspection and refitting	15
Compression test – description and interpretation	2	General information	1
Crankshaft oil seals – renewal	14	Oil pump – removal, inspection and refitting	13
Cylinder head – removal and refitting	11	Sump – removal and refitting	12
Cylinder head cover – removal and refitting	4	Timing belt – general information, removal and refitting	6
Engine assembly/valve timing holes – general information and usage	3	Timing belt covers – removal and refitting	5
Engine oil and filter renewal	See Chapter 1A	Timing belt tensioner and sprockets – removal, inspection and refitting	7
Engine oil level check	See <i>Weekly checks</i>	Valve clearances – checking and adjustment	9

### Degrees of difficulty

**Easy**, suitable for novice with little experience



**Fairly easy**, suitable for beginner with some experience



**Fairly difficult**, suitable for competent DIY mechanic



**Difficult**, suitable for experienced DIY mechanic



**Very difficult**, suitable for expert DIY or professional



### Specifications

#### Engine (general)

##### Designation:

1.4 litre (1360 cc) engine	TU3JP
1.6 litre (1587 cc) engine	TU5JP4

##### Engine codes\*:

1.4 litre engine:	
Up to 2001	KFX
2001 onwards	KFW
1.6 litre engine	NFU

##### Bore:

1.4 litre engine	75.00 mm
1.6 litre engine	78.50 mm

##### Stroke:

1.4 litre engine	77.00 mm
1.6 litre engine	82.00 mm

##### Direction of crankshaft rotation

Clockwise (viewed from right-hand side of vehicle)

##### No 1 cylinder location

At transmission end of the block

##### Compression ratio:

1.4 litre engine	10.5 : 1
1.6 litre engine	11.0 : 1

##### Maximum power output:

1.4 litre engine	55 kW @ 5400 rpm
1.6 litre engine	80 kW @ 5800 rpm

##### Maximum torque output:

1.4 litre engine	120 Nm @ 3400 rpm
1.6 litre engine	147 Nm @ 4000 rpm

\* The engine code is situated on front, left-hand end of the cylinder block.

**Camshaft(s)**

Drive ..... Toothed belt

**Valve clearances (engine cold)**

1.4 litre engine:

Inlet ..... 0.20 mm

Exhaust ..... 0.40 mm

1.6 litre engine ..... Hydraulic adjusters

**Lubrication system**

Oil pump type ..... Gear type, chain-driven off the crankshaft

Minimum oil pressure at 80°C ..... 4 bars @ 4000 rpm

Oil pressure warning switch operating pressure ..... 0.8 bars

**Torque wrench settings**

	Nm	lbf ft
Big-end bearing cap nuts*	40	30
Camshaft bearing housing to cylinder head (1.6 litre engine)	10	7
Camshaft sprocket retaining bolt(s):		
1.4 litre engine:		
M11 bolt with plain washer	80	59
M10 bolt with captive washer	45	33
1.6 litre engine	45	33
Camshaft thrust fork retaining bolt (1.4 litre engine)	16	12
Crankshaft oil seal housing bolts	8	6
Crankshaft pulley retaining bolts	25	18
Crankshaft sprocket retaining bolt*:		
Stage 1	40	30
Stage 2	Angle-tighten a further 45°	
Cylinder head bolts:		
1.4 litre engine:		
Stage 1	20	15
Stage 2	Angle-tighten a further 240°	
1.6 litre engine:		
Stage 1	20	15
Stage 2	Angle-tighten a further 260°	
Cylinder head cover screws/nuts	8	6
Engine-to-transmission bolts:		
1.4 litre engine	40	30
1.6 litre engine	50	37
Engine/transmission left-hand mounting:		
Centre nut	65	48
Mounting bracket-to-transmission nuts:		
1.4 litre engine	25	18
1.6 litre engine	60	44
Mounting bracket-to-body bolts	22	16
Mounting rubber nuts/bolts	25	18
Engine/transmission rear mounting:		
Connecting link-to-mounting rubber nut/bolt	54	40
Connecting link-to-subframe nut/bolt	65	48
Engine/transmission right-hand mounting:		
1.4 litre engine:		
Rubber mounting to body	40	30
Upper bracket-to-cylinder block bracket nuts	45	33
Upper bracket-to-rubber mounting nut	45	33
Support bracket (later models):		
Bracket-to-mounting upper bracket bolt	45	33
Bracket-to-cylinder head bolt	25	18
Lower bracket-to-engine nut/bolt	25	18
1.6 litre engine:		
Rubber mounting to body	40	30
Upper bracket-to-engine bracket bolts	60	44
Upper bracket-to-rubber mounting nut	45	33
Engine bracket-to-cylinder head bolts	45	33
Flywheel bolts*	70	52
Main bearing cap bolts (1.6 litre engine):		
Stage 1	20	15
Stage 2	Angle-tighten a further 49°	

**Torque wrench settings (continued)**

	Nm	lbf ft
Main bearing ladder casting (1.4 litre engine):		
M11 bolts:		
Stage 1 .....	20	15
Stage 2 .....	Angle-tighten a further 44°	
M6 bolts .....	8	6
Oil filter plastic housing (later models) .....	25	18
Oil filter housing to engine block (1.6 litre engine) .....	10	7
Oil pressure switch .....	30	22
Oil pump retaining bolts .....	9	7
Piston oil jet spray tube bolts .....	10	7
Roadwheel bolts .....	90	66
Sump drain plug .....	30	22
Sump retaining nuts and bolts .....	8	6
Timing belt cover bolts .....	8	6
Timing belt tensioner/idler pulley nut:		
1.4 litre engine .....	20	15
1.6 litre engine .....	22	16

\* New nuts/bolts must be used

## 1 General information

### How to use this Chapter

This Part of Chapter 2 describes those repair procedures that can reasonably be carried out on the engine while it remains in the car. If the engine has been removed from the car and is being dismantled, as described in Part D, any preliminary dismantling procedures can be ignored.

Note that, while it may be possible physically to overhaul items such as the piston/connecting rod assemblies while the engine is in the car, such tasks are not normally carried out as separate operations. Usually, several additional procedures (not to mention the cleaning of components and of oilways) have to be carried out. For this reason, all such tasks are classed as major overhaul procedures, and are described in Part D of this Chapter.

Part D describes the removal of the engine/transmission from the vehicle, and the full overhaul procedures that can then be carried out.

### Engine description

The TU series engine is a well-proven unit which has been fitted to many previous Peugeot and Citroën vehicles. The engine is of the in-line four-cylinder, single overhead camshaft (SOHC) 8-valve type on 1.4 litre models, or double overhead camshaft (DOHC) 16-valve type on 1.6 litre models, mounted transversely at the front of the car with the transmission attached to its left-hand end.

The crankshaft runs in five main bearings. Thrustwashers are fitted to No 2 main bearing (upper half) to control crankshaft endfloat.

The connecting rods rotate on horizontally-split bearing shells at their big-ends. The pistons are attached to the connecting rods

by gudgeon pins, which are an interference fit in the connecting rod small-end eyes. The aluminium-alloy pistons are fitted with three piston rings – two compression rings and an oil control ring.

On 1.4 litre engines, the cylinder block is made of aluminium, and wet liners are fitted to the cylinder bores. Sealing O-rings are fitted at the base of each liner, to prevent the escape of coolant into the sump.

On 1.6 litre engines, the cylinder block is made from cast-iron, and the cylinder bores are an integral part of the cylinder block. On this type of engine, the cylinder bores are sometimes referred to as having dry liners.

The inlet and exhaust valves are each closed by coil springs, and operate in guides pressed into the cylinder head; the valve seat inserts are also pressed into the cylinder head, and can be renewed separately if worn.

On 1.4 litre engines, the camshaft is driven by a toothed timing belt, and operates the eight valves via rocker arms. Valve clearances are adjusted by a screw-and-locknut arrangement. The camshaft rotates directly in the cylinder head. The timing belt also drives the coolant pump.

On 1.6 litre engines, the camshafts are driven by a timing belt, and operate the 16 valves via followers incorporating hydraulic compensator units (clearance adjusters). The camshafts rotate directly in the cylinder head and are retained by a one-piece bearing housing. The belt also drives the coolant pump.

Lubrication is by means of an oil pump, which is driven (via a chain and sprocket) off the right-hand end of the crankshaft. It draws oil through a strainer located in the sump, and then forces it through an externally-mounted filter into galleries in the cylinder block/crankcase. From there, the oil is distributed to the crankshaft (main bearings) and camshaft. The big-end bearings are supplied with oil via internal drillings in the crankshaft, while the camshaft bearings also receive a pressurised supply. On 1.6 litre

engines, piston cooling oil spray jets are fitted to spray oil on the underside of each piston. The camshaft lobes and valves are lubricated by splash, as are all other engine components.

### Operations with engine in car

The following work can be carried out with the engine in the car:

- Compression pressure – testing.
- Cylinder head cover – removal and refitting.
- Timing belt covers – removal and refitting.
- Timing belt – removal, refitting and adjustment.
- Timing belt tensioner and sprockets – removal and refitting.
- Camshaft oil seal(s) – renewal.
- Camshaft(s) and rocker arms/followers – removal, inspection and refitting.
- Cylinder head – removal and refitting.
- Cylinder head and pistons – decarbonising.
- Sump – removal and refitting.
- Oil pump – removal, overhaul and refitting.
- Crankshaft oil seals – renewal.
- Engine/transmission mountings – inspection and renewal.
- Flywheel – removal, inspection and refitting.

## 2 Compression test – description and interpretation

**1** When engine performance is down, or if misfiring occurs which cannot be attributed to the ignition or fuel systems, a compression test can provide diagnostic clues as to the engine's condition. If the test is performed regularly, it can give warning of trouble before any other symptoms become apparent.

**2** The engine must be fully warmed-up to normal operating temperature and the battery must be fully charged. The aid of an assistant will also be required.



**3** Referring to Chapter 5B, on early 1.4 litre models, disconnect the LT wiring connector from the ignition HT coil(s). On later 1.4 litre, and all 1.6 litre models, remove the ignition HT coil assembly from the top of the spark plugs. On all models, remove the spark plugs as described in Chapter 1A.

**4** Fit a compression tester to the No 1 cylinder spark plug hole – the type of tester which screws into the plug thread is to be preferred.

**5** Have the assistant hold the throttle wide open, and crank the engine on the starter motor; after one or two revolutions, the compression pressure should build-up to a maximum figure, and then stabilise. Record the highest reading obtained.

**6** Repeat the test on the remaining cylinders, recording the pressure in each.

**7** All cylinders should produce very similar pressures; a difference of more than 2 bars between any two cylinders indicates a fault. Note that the compression should build-up quickly in a healthy engine; low compression on the first stroke, followed by gradually-increasing pressure on successive strokes, indicates worn piston rings. A low compression reading on the first stroke, which does not build-up during successive strokes, indicates leaking valves or a blown head gasket (a cracked head could also be the cause). Deposits on the undersides of the valve heads can also cause low compression.

**8** Although the manufacturer does not specify exact compression pressures, as a guide, any cylinder pressure of below 10 bars can be considered as less than healthy. Refer to a Peugeot/Citroën dealer or other specialist if in doubt as to whether a particular pressure reading is acceptable.

**9** If the pressure in any cylinder is low, carry out the following test to isolate the cause. Introduce a teaspoonful of clean oil into that cylinder through its spark plug hole, and repeat the test.

**10** If the addition of oil temporarily improves the compression pressure, this indicates that

bore or piston wear is responsible for the pressure loss. No improvement suggests that leaking or burnt valves, or a blown head gasket, may be to blame.

**11** A low reading from two adjacent cylinders is almost certainly due to the head gasket having blown between them; the presence of coolant in the engine oil will confirm this.

**12** If one cylinder is about 20 percent lower than the others and the engine has a slightly rough idle, a worn camshaft lobe could be the cause.

**13** If the compression reading is unusually high, the combustion chambers are probably coated with carbon deposits. If this is the case, the cylinder head should be removed and decarbonised.

**14** On completion of the test, refit the spark plugs, ignition HT coil and/or wiring connectors (see Chapters 1A and 5B).

### 3 Engine assembly/valve timing holes – general information and usage

**Note:** Do not attempt to rotate the engine whilst the crankshaft/camshaft are locked in position. If the engine is to be left in this state for a long period of time, it is a good idea to place warning notices inside the vehicle, and in the engine compartment. This will reduce the possibility of the engine being accidentally cranked on the starter motor, which is likely to cause damage with the locking pins in place.

**1** On all models, timing holes are drilled in the camshaft sprocket(s) and in the rear of the flywheel. The holes are used to ensure that the crankshaft and camshaft(s) are correctly positioned when assembling the engine (to prevent the possibility of the valves contacting the pistons when refitting the cylinder head), or refitting the timing belt. When the timing holes are aligned with access holes in the cylinder head and the front of the cylinder block, suitable diameter bolts/pins can be

inserted to lock both the camshaft and crankshaft in position, preventing them from rotating. Proceed as follows.

**2** Remove the timing belt upper cover as described in Section 5.

**3** On later engines with a plastic oil filter housing, access to the flywheel timing hole is improved if the oil filter is removed (see Chapter 1A).

#### 1.4 litre engines

**4** The crankshaft must now be turned until the timing hole in the camshaft sprocket is aligned with the corresponding hole in the cylinder head. The holes are aligned when the camshaft sprocket hole is in the 2 o'clock position, when viewed from the right-hand end of the engine. The crankshaft can be turned by using a spanner on the crankshaft sprocket bolt, noting that it should always be rotated in a clockwise direction (viewed from the right-hand end of the engine).

**5** With the camshaft sprocket hole correctly positioned, insert a 6 mm diameter stud or pin, 90 mm long, (ideally, welded to a length of weld rod bent to the appropriate shape), through the hole in the front left-hand flange of the cylinder block, and locate it in the timing hole in the rear of the flywheel (see illustration). A purpose-made tool is available from dealers. Note that it may be necessary to rotate the crankshaft slightly to get the holes to align.

**6** With the flywheel correctly positioned, insert a 10 mm diameter bolt or pin through the timing hole in the camshaft sprocket, and locate it in the hole in the cylinder head (see illustration).

**7** The crankshaft and camshaft are now locked in position, preventing unnecessary rotation.

#### 1.6 litre engines

**8** Turn the crankshaft until the holes in the camshaft sprockets align with the corresponding holes in the cylinder head. The crankshaft can be turned by using a spanner

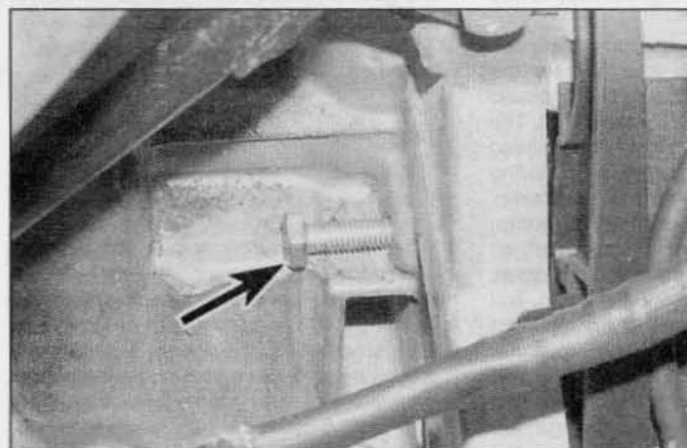

**3.5** Insert a 6 mm diameter bolt/pin (arrowed) into the hole in the cylinder block flange and into the flywheel hole

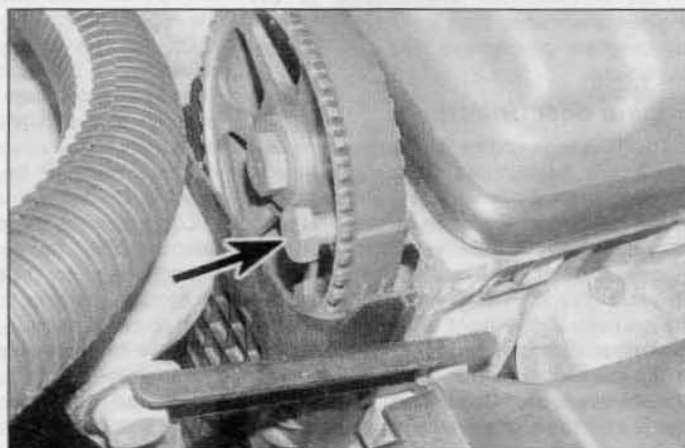

**3.6** Lock the camshaft sprocket in position with a 10 mm diameter bolt/pin (arrowed) – 1.4 litre engines

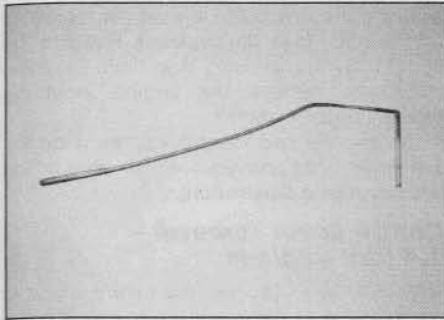

3.9a Weld a 90 mm length of 6 mm rod/stud to a length of weld rod . . .

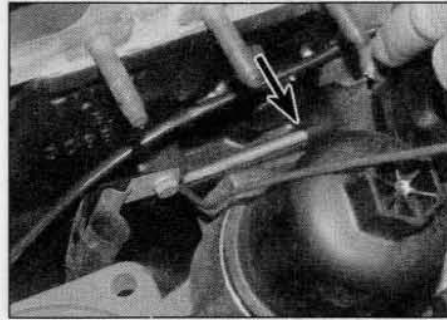

3.9b . . . and insert it into the hole in the cylinder block flange (arrowed)

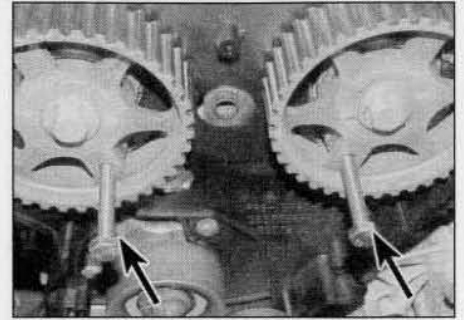

3.10 Use 10 mm diameter bolts/pins (arrowed) to lock the camshaft sprockets in position – 1.6 litre engines

on the crankshaft sprocket bolt, noting that it should always be rotated in a clockwise direction (viewed from the right-hand end of the engine).

9 With the camshaft sprocket holes correctly positioned, insert a 6 mm diameter stud or pin, 80 mm long, welded to a length of weld rod bent to the appropriate shape, through the hole in the front left-hand flange of the cylinder block, and locate it in the timing hole in the rear of the flywheel (see illustrations). A purpose-made tool is available from dealers. Note that it may be necessary to rotate the crankshaft slightly to get the holes to align.

10 With the crankshaft correctly positioned, insert 10 mm diameter bolts or pins through the timing holes in the camshaft sprockets, and locate them in the holes in the cylinder head (see illustration).

11 The crankshaft and camshafts are now locked in position, preventing unnecessary rotation.

#### 4 Cylinder head cover – removal and refitting



##### 1.4 litre engines

###### Removal

1 Disconnect the battery negative terminal (refer to *Disconnecting the battery* in the Reference Chapter).

2 Depress the clip and disconnect the breather hose from the cylinder head cover (see illustration).

3 On later models, remove the ignition HT coil assembly from the top of the spark plugs as described in Chapter 5B.

4 Undo the two retaining nuts and sealing washers (where fitted) then lift off the cylinder head cover, complete with its rubber seal. Examine the seal for signs of damage and deterioration, and if necessary, renew it.

5 Remove the spacer from each cover stud then lift off the oil baffle plate (see illustrations).

###### Refitting

6 Carefully clean the cylinder head and cover mating surfaces, and remove all traces of oil.

7 Fit the rubber seal over the edge of the cylinder head cover, ensuring that it is correctly located along its entire length (see illustration).

8 Refit the oil baffle plate then fit the spacers to the cover studs.

9 Carefully refit the cylinder head cover to the engine, taking great care not to displace the rubber seal.

10 Fit the sealing washers (where fitted) and cover retaining nuts, tightening them to the specified torque.

11 Where applicable, refit the ignition HT coil (see Chapter 5B) then reconnect the breather hose to the cylinder head cover. On completion reconnect the battery.

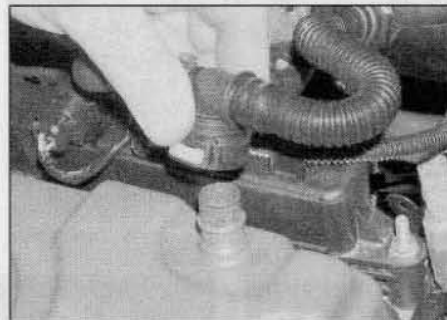

4.2 Disconnect the breather hose from the cylinder head cover



4.5a Remove the spacers (arrowed) from the studs . . .

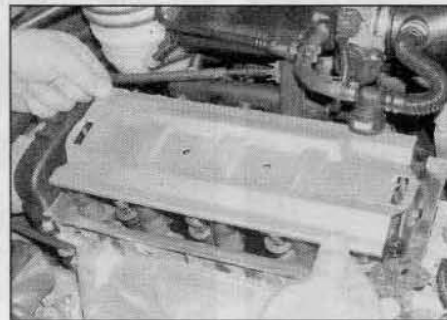

4.5b . . . then lift off the baffle plate

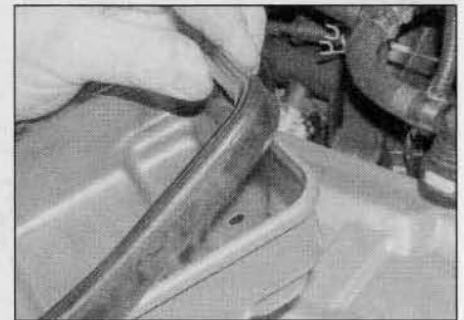

4.7 Ensure the rubber seal is correctly located on the cylinder head cover

##### 1.6 litre engines

###### Removal

12 Disconnect the battery negative terminal (refer to *Disconnecting the battery* in the Reference Chapter), and remove the ignition coil as described in Chapter 5B.

13 Working in a spiral pattern, progressively and evenly slacken the cylinder head cover bolts, and remove the covers. Recover the gaskets.

###### Refitting

14 Carefully clean the cylinder head and cover mating surfaces, and remove all traces of oil.

15 Check the condition of the cover's composite gasket, and re-use it if undamaged. If it is damaged, a repair may be effected using silicone sealing compound.



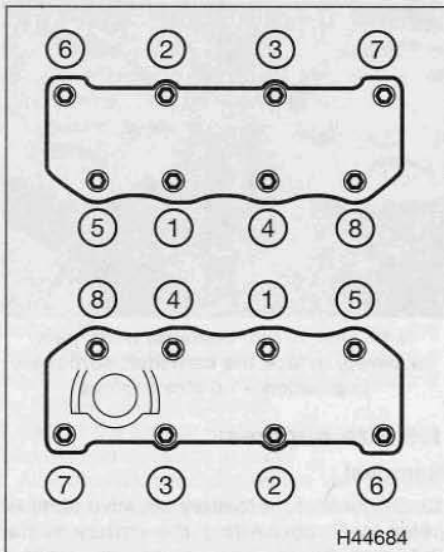

H44684

**4.16 Cylinder head cover bolts tightening sequence**

- 16 Refit the cover(s) and tighten the bolts in sequence (see illustration).
- 17 Refit the ignition coil (Chapter 5B).
- 18 Reconnect the battery.

**5 Timing belt covers – removal and refitting**

**Upper cover removal**

**1.4 litre engines**

1 Slacken and remove the two retaining bolts (one at the front and one at the rear), and remove the upper timing cover from the cylinder head (see illustrations).

**1.6 litre engines**

2 Position a trolley jack under the engine, with a block of wood between the jack head and the sump to prevent damage. Raise the jack to take the weight of the engine.

3 Undo the two bolts and move the accelerator pedal position sensor and mounting bracket clear of the right-hand engine mounting (see illustration).

4 Release the purge valve vapour hose from the clip on the right-hand engine mounting and move the hose aside slightly.

5 Undo the three bolts securing the right-hand engine mounting upper bracket to the bracket on the engine, and the centre nut

securing the bracket to the rubber mounting on the body (see illustration). Remove the upper mounting bracket, then undo the three bolts and remove the engine mounting bracket from the engine.

6 Slacken the two lower bolts, then undo the five upper bolts and remove the upper timing belt cover (see illustration).

**Centre cover removal – 1.4 litre engines**

**Note:** On later engines the centre cover is combined with the lower cover and is not a separate component.

7 Remove the upper cover as described in paragraph 1, then free the wiring from its retaining clips on the centre cover.

8 Slacken and remove the three retaining bolts (one at the rear of the cover, beneath the engine mounting plate, and two directly above the crankshaft pulley), and manoeuvre the centre cover out from the engine compartment (see illustration).

**Lower cover removal**

9 Remove the auxiliary drivebelt as described in Chapter 1A.

10 Remove the upper and, where applicable, the centre covers as described previously.



5.1a Unscrew the retaining bolts (arrowed) ...



5.1b ... and remove the timing belt upper cover

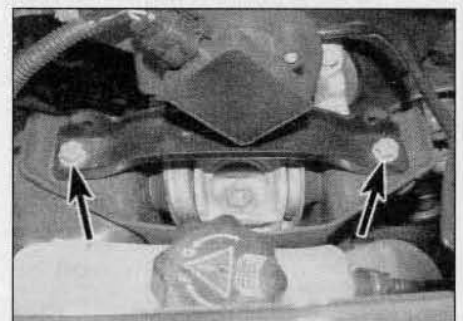

5.3 Accelerator pedal position sensor mounting bracket retaining bolts (arrowed)

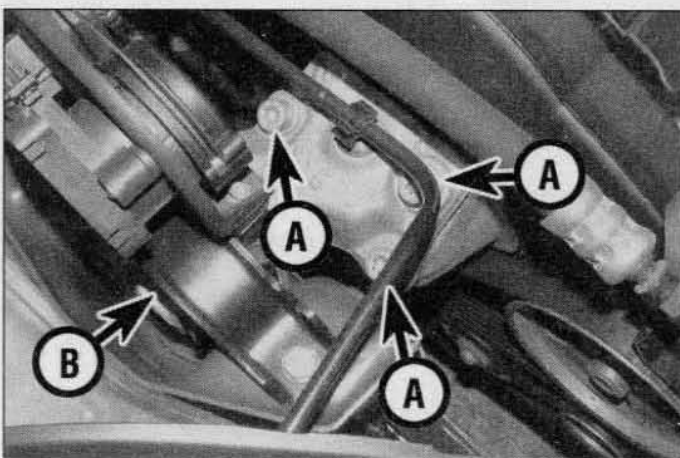

5.5 Undo the three bolts (A) and the centre nut (B) then remove the engine mounting upper bracket

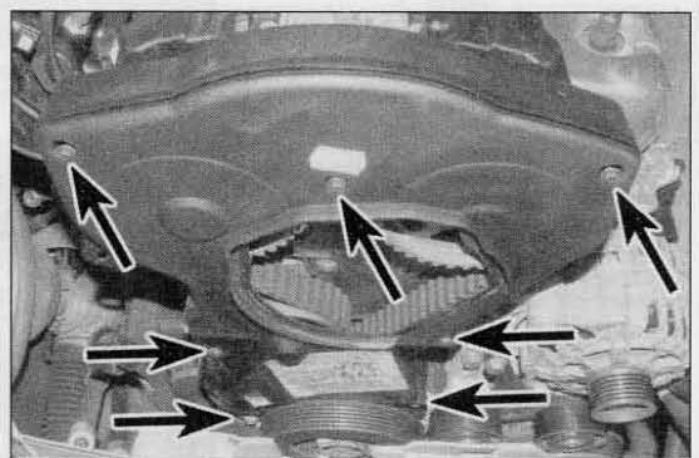

5.6 Timing belt upper cover retaining bolts (arrowed)



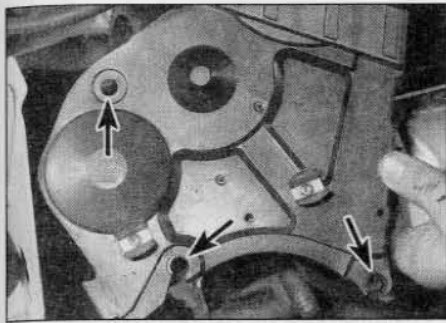

5.8 Undo the three bolts (locations arrowed) and remove the centre cover

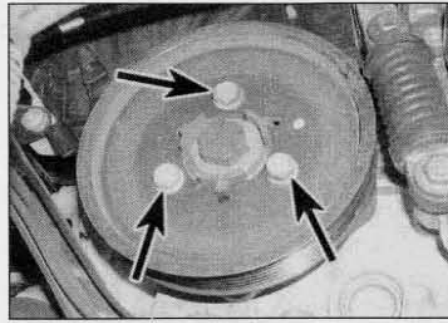

5.11a Undo the retaining bolts (arrowed) . . .

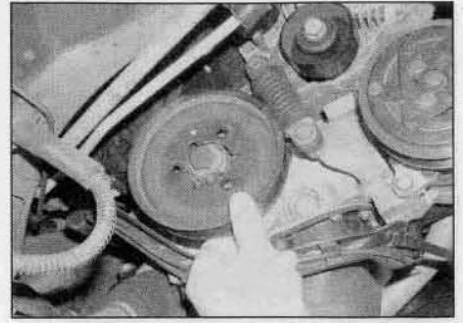

5.11b . . . and remove the crankshaft pulley

11 Undo the three crankshaft pulley retaining bolts and remove the pulley, noting which way round it is fitted (see illustrations).

12 Slacken and remove the retaining bolts then remove the lower cover from the engine (see illustration).

#### Inner cover removal – 1.6 litre engines

13 Remove the camshaft sprockets and tensioner pulley as described in Section 7.

14 Undo the bolts and remove the inner cover (see illustration).

#### Refitting

##### Upper cover

15 Refitting is the reverse of removal. On 1.6 litre engines, tighten the engine mounting retaining bolts to the specified torque.

##### Centre cover – 1.4 litre engines

16 Manoeuvre the centre cover back into position, ensuring it is correctly located with the lower cover, and tighten its retaining bolts.

17 Clip the wiring loom into its retaining clips on the front of the centre cover, then refit the upper cover as described in paragraph 15.

##### Lower cover

18 Locate the lower cover over the timing belt sprocket, and tighten its retaining bolts.

19 Fit the pulley to the end of the crankshaft, ensuring it is fitted the correct way round, and tighten its bolts to the specified torque.

20 Refit centre (where applicable) and upper covers as described above.

21 Refit and tension the auxiliary drivebelt as described in Chapter 1A.

#### Inner cover – 1.6 litre engines

22 Refitting is a reversal of removal. Ensure that the cupped lower edge of the cover engages correctly with the lip at the top of the crankshaft oil seal housing as the cover is refitted.

#### 6 Timing belt – general information, removal and refitting

**Note:** On early 1.4 litre engines, the manufacturer's specify the use of a special electronic tool (SEEM C.TRONIC type 105 belt tensioning measuring tool, and valve rocker contact plate (-).0132 AE) to correctly set the timing belt tension. If access to this equipment cannot be obtained, an approximate setting can be achieved using the method described below. If the method described is used, the tension must be checked using the special electronic tool at the earliest possible

opportunity. Do not drive the vehicle over large distances, or use high engine speeds, until the belt tension is known to be correct.

#### General information

1 The timing belt drives the camshaft(s) and coolant pump from a toothed sprocket on the front of the crankshaft. If the belt breaks or slips in service, the pistons are likely to hit the valve heads, resulting in extensive (and expensive) damage.

2 The timing belt should be renewed at the specified intervals (see Chapter 1A), or earlier if it is contaminated with oil, or if it is at all noisy in operation (a 'scraping' noise due to uneven wear).

3 If the timing belt is being removed, it is a wise precaution to check the condition of the coolant pump at the same time (check for signs of coolant leakage). This may avoid the need to remove the timing belt again at a later stage, should the coolant pump fail.

4 On later 1.4 litre engines an automatic timing belt tensioner is used to maintain the correct tension on the timing belt after the initial setting procedure has been carried out. The automatic type tensioner can be identified by the index arm and tension position marks on the side of the tensioner body (see illustration 6.33). If this type of tensioner is

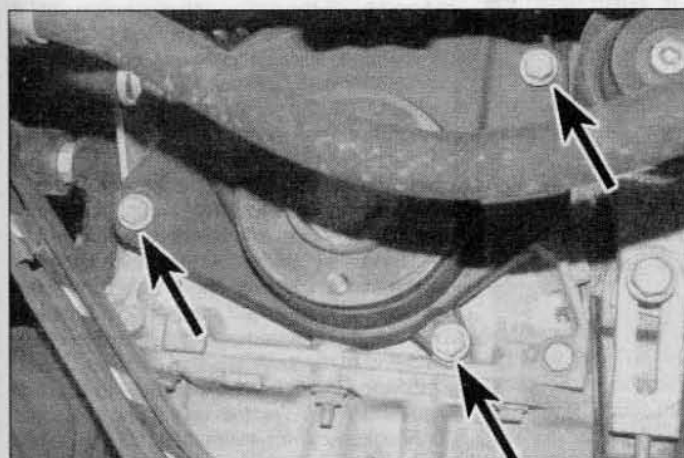

5.12 Undo the bolts (arrowed) and remove the timing belt lower cover

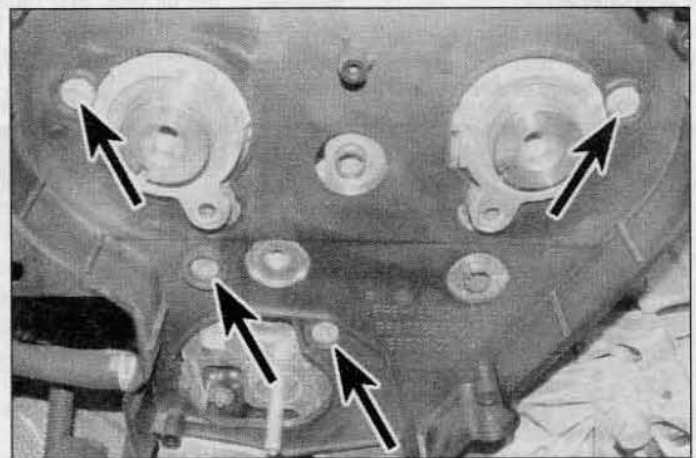

5.14 Undo the bolts (arrowed) and remove the inner cover

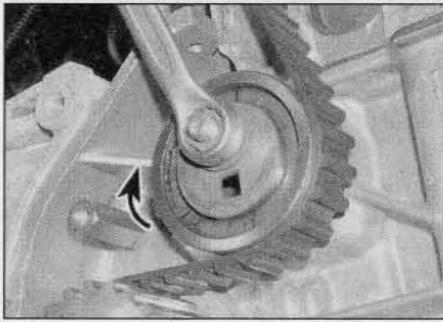

**6.8** Slacken the nut then pivot the tensioner pulley clockwise to relieve the timing belt tension – 1.4 litre engines

fitted, follow the procedures for 'later 1.4 litre engines' when refitting the timing belt.

### Removal

**5** Disconnect the battery negative terminal (refer to *Disconnecting the battery* in the Reference Chapter).

**6** Align the engine assembly/valve timing holes as described in Section 3, and lock both the camshaft sprocket and the flywheel in position.

**Caution: Do not attempt to rotate the engine whilst the locking tools are in position.**

**7** Remove the remaining timing belt cover(s) as described in Section 5.

### 1.4 litre engines

**8** Loosen the timing belt tensioner pulley retaining nut (see illustration). Pivot the pulley approximately 60° in a clockwise direction, using a key fitted to the hole in the pulley hub, then retighten the retaining nut. On early engines, an 8 mm square section key will be required (see **Tool Tip**), and on later engines with an automatic tensioner, an Allen key will be needed.

**9** If the timing belt is to be re-used, use white paint or similar to mark the direction of rotation on the belt (if markings do not already exist). Slip the belt off the sprockets.

### 1.6 litre engines

**10** Slacken the timing belt tensioner pulley retaining nut and, using a hexagonal key, rotate the pulley clockwise until the index arm

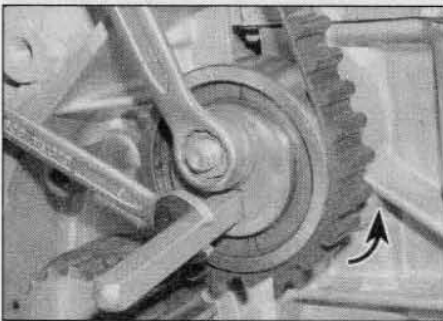

**6.16** Pivot the tensioner pulley anti-clockwise to remove all freeplay from the timing belt then tighten the pulley nut

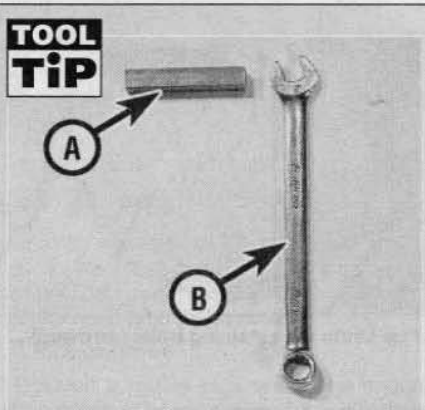

**TOOL TIP**  
If you're having difficulty finding a square-section tool that will fit the tensioner pulley, obtain a length of standard 8 mm door handle rod from a DIY shop and cut it to length (A). Insert the rod into the pulley hub and rotate the pulley with an 8 mm spanner (B).

is in the minimum tension position (see illustration). Temporarily tighten the tensioner pulley nut in this position.

**11** If the timing belt is to be re-used, use white paint or similar to mark the direction of rotation on the belt (if markings do not already exist). Slip the belt off the sprockets.

### All engines

**12** Check the timing belt carefully for any signs of uneven wear, splitting, or oil contamination. Pay particular attention to the roots of the teeth. Renew the belt if there is the slightest doubt about its condition. If the engine is undergoing an overhaul, and has covered more than 40 000 miles (60 000 km) with the existing belt fitted, renew the belt as a matter of course, regardless of its apparent condition. The cost of a new belt is nothing when compared to the cost of repairs, should the belt break in service. If signs of oil contamination are found, trace the source of the oil leak, and rectify it. Wash down the engine timing belt area and all related components, to remove all traces of oil.

**13** Prior to refitting, thoroughly clean the timing belt sprockets. Check that the tensioner and pulleys rotate freely, without any sign of roughness. If necessary, renew the pulleys as described in Section 7. Make sure that the locking tools are still in place, as described in Section 3.

### Refitting – early 1.4 litre engines

**14** Manoeuvre the timing belt into position, ensuring that the arrows on the belt are pointing in the direction of rotation (clockwise, when viewed from the right-hand end of the engine).

**15** Do not twist the timing belt sharply while refitting it. Fit the belt over the crankshaft and camshaft sprockets. Make sure that the 'front

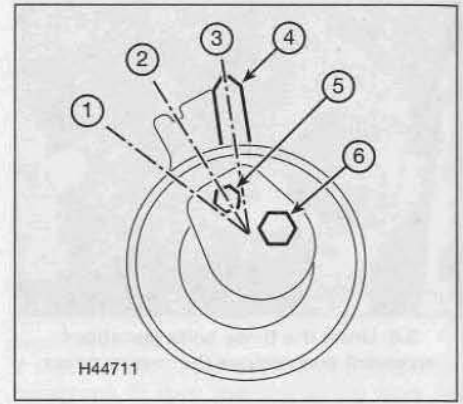

**6.10** Timing belt tensioner – 1.6 litre engines

- 1 Minimum tension position
- 2 Normal tension position
- 3 Maximum tension position
- 4 Index arm
- 5 Hole for hexagonal key
- 6 Tensioner pulley bolt

run' of the belt is taut – ie, ensure that any slack is on the tensioner pulley side of the belt. Fit the belt over the coolant pump sprocket and tensioner pulley. Ensure that the belt teeth are seated centrally in the sprockets.

**16** Loosen the tensioner pulley retaining nut. Pivot the pulley anti-clockwise to remove all free play from the timing belt, then retighten the nut (see illustration). Tension the timing belt as described under the relevant sub-heading.

### Tensioning without the special electronic measuring tool

**Note: If this method is used, ensure that the belt tension is checked using the electronic measuring tool at the earliest possible opportunity.**

**17** If the special tool is not available, an approximate setting may be achieved as follows. Slacken the tensioner pulley retaining nut and pivot the pulley anti-clockwise until it is just possible to twist the timing belt through 90° by finger and thumb, midway between the crankshaft and camshaft sprockets. The deflection of the belt at the mid-point between the sprockets should be approximately 6.0 mm. Hold the tensioner pulley in this position and tighten the retaining nut.

**18** Remove the locking tools from the camshaft sprocket and flywheel.

**19** Using a suitable socket and extension bar on the crankshaft sprocket bolt, rotate the crankshaft through four complete rotations in a clockwise direction (viewed from the right-hand end of the engine).

**Caution: Do not at any time rotate the crankshaft anti-clockwise.**

**20** Slacken the tensioner pulley nut, retension the belt as described in paragraph 17, then tighten the tensioner pulley nut to the specified torque.



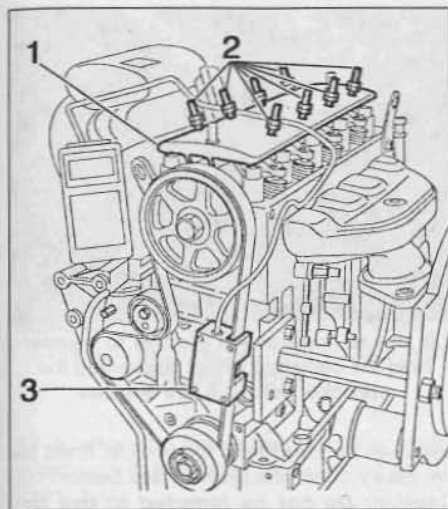

**6.26** Fit the rocker arm plate (1) to the cylinder head and use the contact bolts (2) to lift the rocker arms clear of the camshaft (see text). Note the correct location for the measuring tool (3)

21 Rotate the crankshaft through a further two turns clockwise, and check that both the camshaft sprocket and flywheel timing holes are still correctly aligned.

22 If all is well, refit the timing belt covers as described in Section 5, and reconnect the battery negative terminal.

#### Tensioning using the special electronic measuring tool

23 Fit the special belt tensioning measuring equipment to the front run of the timing belt, approximately midway between the camshaft and crankshaft sprockets. Position the tensioner pulley so that the belt is tensioned to a setting of 44 SEEM units, then retighten its retaining nut.

24 Remove the locking tools from the camshaft sprocket and flywheel, and remove the measuring tool from the belt.

25 Using a suitable socket and extension bar on the crankshaft sprocket bolt, rotate the crankshaft through four complete rotations in a clockwise direction (viewed from the right-hand end of the engine). Do not at any time rotate the crankshaft anti-clockwise. Refit the locking tool to the flywheel and check that the camshaft sprocket timing hole is aligned.

26 To ensure an accurate reading, it is necessary to remove the valve spring load from the camshaft by fitting the valve rocker contact plate (-).0132 AE. Remove the cylinder head cover (see Section 4), then slacken the eight rocker arm contact bolts in the valve rocker contact plate. Fit the contact plate to the cylinder head cover studs, observing the correct fitted direction, and secure it with the cover nuts (see illustration). Tighten each rocker arm contact bolt until the rockers are just free of the camshaft lobes. Do not over-tighten the contact bolts otherwise the valves will contact the pistons.

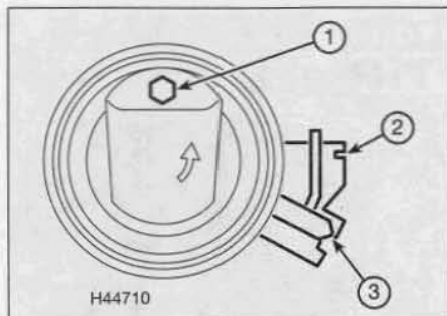

**6.33** Timing belt tensioner – later 1.4 litre engines

- 1 Hole for hexagonal key
- 2 Normal tension position
- 3 Maximum tension position

27 Refit the measuring tool to the belt, slacken the tensioner pulley retaining nut, and gradually release the tensioner pulley until a setting of between 29 and 33 SEEM units is indicated on the measuring tool. Retighten the tensioner pulley retaining nut to the specified torque.

28 Remove the measuring tool from the belt then unscrew the nuts and remove the rocker arm contact plate from the cylinder head.

29 Remove the flywheel locking tool, then rotate the crankshaft through another four complete rotations in a clockwise direction. Refit the flywheel locking tool and check that the camshaft timing hole is correctly aligned with the cylinder head hole.

30 If all is well, refit the timing belt covers and cylinder head cover as described in Sections 4 and 5. **Note:** If the rocker arm adjusting screws were moved, adjust the valve clearances before refitting the cylinder head cover.

#### Refitting – later 1.4 litre engines

31 Manoeuvre the timing belt into position, ensuring that the arrows on the belt are pointing in the direction of rotation (clockwise, when viewed from the right-hand end of the engine).

32 Do not twist the timing belt sharply while refitting it. Fit the belt over the crankshaft and

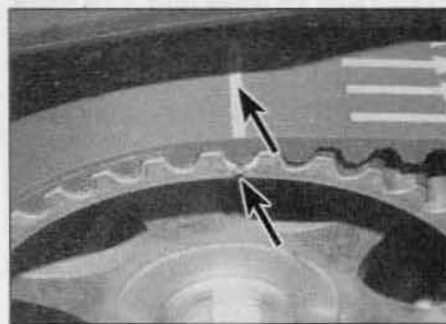

**6.40** Note the timing belt marks which correspond to the camshaft sprockets and crankshaft sprocket – 1.6 litre engines

camshaft sprockets. Make sure that the 'front run' of the belt is taut – ie, ensure that any slack is on the tensioner pulley side of the belt. Fit the belt over the coolant pump sprocket and tensioner pulley. Ensure that the belt teeth are seated centrally in the sprockets.

33 Remove the crankshaft and camshaft locking tools, then slacken the tensioner pulley nut and, using a hexagonal key, rotate the pulley anti-clockwise until the index arm is in the maximum tension position (see illustration). Tighten the pulley retaining nut.

34 Using a socket on the crankshaft pulley bolt, rotate the crankshaft clockwise 10 complete revolutions, and refit the crankshaft locking tool as described in Section 3.

35 Check the timing is correct by inserting the camshaft sprocket locking tool (Section 3). If the tool cannot be inserted, slacken the tensioner, remove the belt, refit the locking tools, and start again from paragraph 31.

36 Remove the crankshaft and camshaft locking tools.

37 Hold the hexagonal key in the tensioner pulley to maintain the tension, then slacken the pulley nut, and rotate the tensioner to bring the index arm to the normal tension position (see illustration 6.33). Tighten the pulley nut to the specified torque.

38 Rotate the crankshaft two complete revolutions, and check that the crankshaft and camshaft locking tools can still be inserted.

39 The remainder of refitting is a reversal of removal.

#### Refitting – 1.6 litre engines

40 Manoeuvre the timing belt into position, ensuring that the arrows on the belt are pointing in the direction of rotation (clockwise, when viewed from the right-hand end of the engine). Note that there are three marks on a new belt which correspond to marks on the crankshaft and camshaft sprockets (see illustration).

41 Do not twist the timing belt sharply while refitting it. Fit the belt over the crankshaft and camshaft sprockets aligning the marks on the belt with those on the crankshaft and camshaft sprockets. Make sure that the 'front run' of the belt is taut – ie, ensure that any slack is on the tensioner pulley side of the belt. Fit the belt over the coolant pump sprocket, idler pulley and tensioner pulley. Ensure that the belt teeth are seated centrally in the sprockets.

42 Insert the hexagonal key on the tensioner pulley, slacken the pulley nut and rotate the key to bring the index arm to the maximum tension position (see illustration 6.10). Tighten the tensioner roller nut securely.

43 Remove the camshaft and crankshaft locking tools, and rotate the crankshaft 4 complete revolutions clockwise, and refit the crankshaft locking tool.

44 Insert the hexagon key in the tensioner, slacken the nut and rotate the tensioner using the key, until the index arm is in the normal



tension position (see illustration 6.10). Tighten the tensioner nut to the specified torque.

45 Remove the crankshaft locking tool, and rotate the crankshaft two complete revolutions clockwise. Check the position of the tensioner index arm – it should be no more than 2.0 mm away from the normal tension position. If it is, repeat the belt fitting procedure from paragraph 40.

46 Refit the timing belt covers as described in Section 5, then on completion, reconnect the battery.

## 7 Timing belt tensioner and sprockets – removal, inspection and refitting



### Removal

#### Camshaft sprocket – 1.4 litre engines

1 Remove the timing belt as described in Section 6.

2 Withdraw the crankshaft and camshaft locking tools, and using a spanner or socket on the crankshaft pulley bolt, rotate the crankshaft backwards (anti-clockwise) 90°. This is to prevent any accidental contact between the pistons and valves.

3 Slacken the camshaft sprocket retaining bolt and remove it, along with its washer. To prevent the camshaft rotating as the bolt is slackened, a sprocket-holding tool will be required. In the absence of the manufacturer's special tool, an acceptable substitute can be fabricated as follows. Use two lengths of steel strip (one long, the other short), and three nuts and bolts; one nut and bolt forms the pivot of a forked tool, with the remaining two nuts and bolts at the tips of the 'forks' to engage with the sprocket spokes (see Tool Tip).

**Caution:** Do not attempt to use the sprocket locking pin to prevent the sprocket from rotating whilst the bolt is slackened.

4 With the retaining bolt removed, slide the sprocket off the end of the camshaft. If the sprocket locating pin is a loose fit, remove it for safe-keeping. Examine the camshaft oil seal for signs of oil leakage and, if necessary, renew it as described in Section 8.

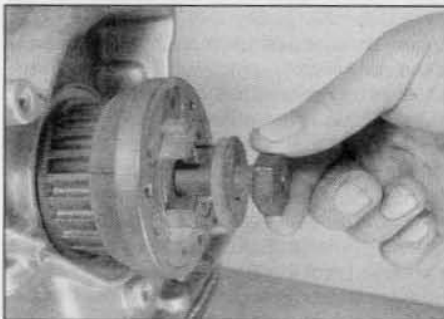

7.12a Remove the retaining bolt and washer ...



**TOOL TIP**  
Using a home-made tool to hold the camshaft sprocket stationary whilst the bolt is tightened (shown with the cylinder head removed).

#### Camshaft sprockets – 1.6 litre engines

5 Remove the cylinder head covers as described in Section 4.

6 Remove the timing belt as described in Section 6.

7 Withdraw the crankshaft and camshaft locking tools, and using a spanner or socket on the crankshaft pulley bolt, rotate the crankshaft backwards (anti-clockwise) 90°. This is to prevent any accidental contact between the pistons and valves.

8 Using an open-ended spanner on the square section to counter-hold the camshaft, undo the sprocket retaining bolt (see illustration).

**Caution:** Do not attempt to use the sprocket locking pin to prevent the sprocket from rotating whilst the bolt is slackened.

9 With the retaining bolt removed, slide the sprocket off the end of the camshaft. Note that the key is integral with the sprocket. Examine the camshaft oil seals for signs of oil leakage and, if necessary, renew as described in Section 8.

#### Crankshaft sprocket

10 Remove the timing belt as described in Section 6.

11 Slacken the crankshaft sprocket bolt. To prevent crankshaft rotation as the bolt is slackened, select top gear, and have an assistant apply the brakes firmly. If the engine

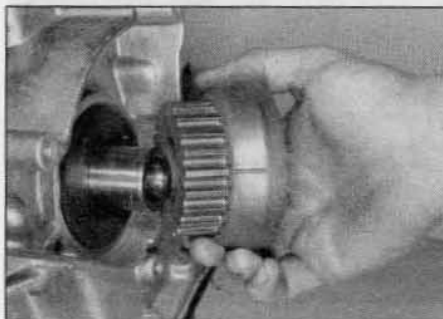

7.12b ... then slide off the crankshaft sprocket

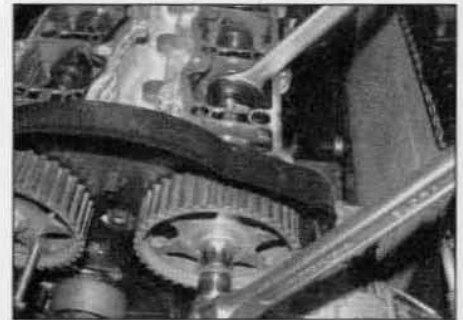

7.8 Use an open-ended spanner to counter-hold the camshaft whilst slackening the sprocket bolt – 1.6 litre engines

has been removed from the vehicle, it will be necessary to lock the flywheel (see Section 15). **Caution:** Do not be tempted to use the flywheel locking pin to prevent the crankshaft from rotating; temporarily remove the locking pin prior to slackening the pulley bolt, then refit it once the bolt has been slackened.

12 Unscrew the retaining bolt and washer, then slide the sprocket off the end of the crankshaft (see illustrations).

13 If the Woodruff key is a loose fit in the crankshaft, remove it and store it with the sprocket for safe-keeping. If necessary, also slide the flanged spacer (where fitted) off the end of the crankshaft (see illustration). Examine the crankshaft oil seal for signs of oil leakage and, if necessary, renew as described in Section 14.

#### Tensioner pulley

14 Remove the lower timing belt cover (see Section 5).

15 Lock the camshaft and crankshaft at TDC on No 1 cylinder as described in Section 3.

16 Slacken and remove the timing belt tensioner pulley retaining nut, and slide the pulley off its mounting stud. Examine the mounting stud for signs of damage and, if necessary, renew it.

#### Idler pulley

17 Remove the lower timing belt cover (see Section 5).

18 Lock the camshaft and crankshaft at TDC on No 1 cylinder as described in Section 3.



7.13 Remove the Woodruff key and flanged spacer (where fitted) from the crankshaft

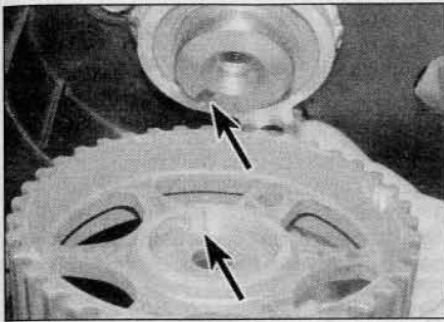

7.24a The locating pin must engage with the slot (arrowed)

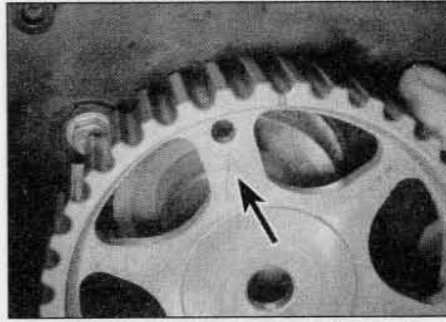

7.24b On 1.6 litre engines, the inlet sprocket is marked A (arrowed) and the exhaust E

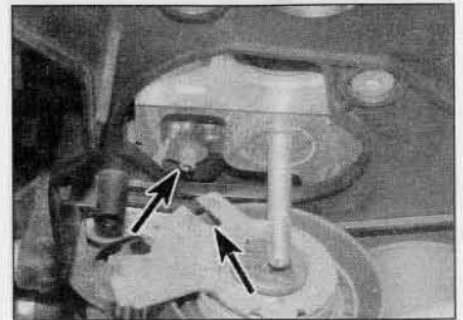

7.37 The cut-out aligns the locating pin (arrowed)

19 Slacken the timing belt tensioner pulley retaining nut, to release the tension from the timing belt.

20 Slacken and remove the timing belt idler pulley retaining nut, and slide the pulley off its mounting stud. Examine the mounting stud for signs of damage and, if necessary, renew it.

### Inspection

21 Clean the sprockets thoroughly, and renew any that show signs of wear, damage or cracks.

22 Clean the tensioner/idler pulleys, but do not use any strong solvent which may enter the pulley bearings. Check that the pulleys rotate freely about their hubs, with no sign of stiffness or of free play. Renew them if there is any doubt about their condition, or if there are any obvious signs of wear or damage.

23 Inspect the timing belt (see Section 6). Renew the belt if there is any doubt about its condition.

### Refitting

#### Camshaft sprocket

24 Refit the locating pin (where removed) then locate the sprocket on the end of the camshaft. Ensure that the locating pin is correctly engaged with the sprocket and the cut-out in the camshaft end. Note that on 1.6 litre engines, the exhaust sprocket is marked E and the inlet sprocket is marked A (see illustrations).

25 Refit the sprocket retaining bolt and washer. Tighten the bolt to the specified torque, whilst retaining the sprocket/camshaft with the method used on removal.

26 Realign the timing hole in the camshaft sprocket (see Section 3) with the corresponding hole in the cylinder head, and refit the locking pin.

27 Rotate the crankshaft 90° in the normal direction of rotation (clockwise), until the crankshaft locking pin can be inserted.

28 Refit the timing belt as described in Section 6. On 1.6 litre engines, refit the cylinder head covers as described in Section 4.

#### Crankshaft sprocket

29 Locate the Woodruff key in the crankshaft

end, then slide on the flanged spacer (where fitted) aligning its slot with the Woodruff key.

30 Align the crankshaft sprocket slot with the Woodruff key, and slide it onto the end of the crankshaft.

31 Temporarily remove the locking pin from the rear of the flywheel, then refit the crankshaft sprocket retaining bolt and washer. Tighten the bolt to the specified torque, whilst preventing crankshaft rotation using the method employed on removal. Refit the locking pin to the rear of the flywheel.

32 Refit the timing belt as described in Section 6.

#### Idler pulley

33 Refit the idler pulley to its mounting stud, refit the retaining nut and tighten it to the specified torque.

34 Ensure that the 'front run' of the timing belt is taut - ie, ensure that any slack is on the pulley side of the belt. Check that the belt is centrally located on all its sprockets. Rotate the tensioner pulley anti-clockwise to remove all free play from the timing belt, then tighten the pulley retaining nut securely.

35 Tension the timing belt as described in Section 6.

36 Once the belt is correctly tensioned, refit the timing belt covers as described in Section 5.

#### Tensioner pulley

37 Refit the tensioner pulley to its mounting stud, ensuring the cut-out aligns with the pin (see illustration), and fit the retaining nut.



8.3 Carefully prise the camshaft oil seal out with a flat-bladed screwdriver

38 Ensure that the 'front run' of the belt is taut - ie, ensure that any slack is on the pulley side of the belt. Check that the belt is centrally located on all its sprockets. Rotate the pulley anti-clockwise to remove all free play from the timing belt, then tighten the pulley retaining nut securely.

39 Tension the timing belt as described in Section 6.

40 Once the belt is correctly tensioned, refit the timing belt covers as described in Section 5.

## 8 Camshaft oil seal(s) - renewal

**Note:** If the camshaft oil seal has been leaking, check the timing belt for signs of oil contamination; the belt must be renewed if signs of oil contamination are found. Ensure that all traces of oil are removed from the sprockets and surrounding area before the new belt is fitted.

1 Remove the camshaft sprocket as described in Section 7.

2 Note the fitted depth of the oil seal in relation to the cylinder head face as a guide for refitting.

3 Punch or drill two small holes opposite each other in the oil seal. Screw a self-tapping screw into each, and pull on the screws with pliers to extract the seal. Alternatively, carefully prise the seal out using a flat-bladed screwdriver (see illustration).

4 Clean the seal housing, and polish off any burrs or raised edges, which may have caused the seal to fail in the first place.

5 Lubricate the lips of the new seal with clean engine oil, and drive it into position until it is at the fitted depth as noted during removal. Use a suitable tubular drift, such as a socket, which bears only on the hard outer edge of the seal. Take care not to damage the seal lips during fitting. Note that the seal lips should face inwards.

6 Refit the camshaft sprocket as described in Section 7.



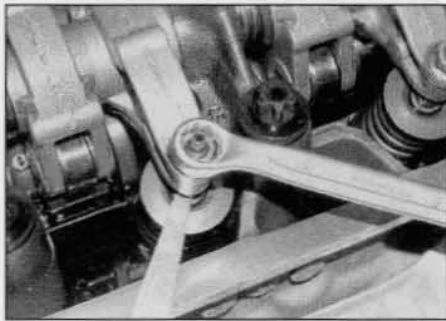

9.5 Check the valve clearances using feeler gauges

## 9 Valve clearances – checking and adjustment

**Note 1:** The valve clearances must be checked and adjusted only when the engine is cold.

**Note 2:** This procedure applies only to 1.4 litre engines – the valve clearances on 1.6 litre engines are maintained by hydraulic compensator units built into the cam followers.

1 The importance of having the valve clearances correctly adjusted cannot be overstressed, as they vitally affect the performance of the engine. If the clearances are too big, the engine will be noisy (characteristic rattling or tapping noises) and engine efficiency will be reduced, as the valves open too late and close too early. A more serious problem arises if the clearances are too small, however. If this is the case, the valves may not close fully when the engine is hot, resulting in serious damage to the engine (eg, burnt valve seats and/or cylinder head warping/cracking). The clearances are checked and adjusted as follows.

2 Remove the cylinder head cover as described in Section 4.

3 The engine can now be turned using a suitable socket and extension bar fitted to the crankshaft sprocket bolt.

4 It is important that the clearance of each valve is checked and adjusted only when the valve is fully closed, with the rocker arm resting on the heel of the cam (directly opposite the peak). This can be ensured by carrying out the

adjustments in the following sequence, noting that No 1 cylinder is at the transmission end of the engine. The correct valve clearances are given in the Specifications at the start of this Chapter. The valve locations can be determined from the position of the manifolds.

### Valve fully open Adjust valves

No 1 exhaust	No 3 inlet and No 4 exhaust
No 3 exhaust	No 4 inlet and No 2 exhaust
No 4 exhaust	No 2 inlet and No 1 exhaust
No 2 exhaust	No 1 inlet and No 3 exhaust

5 With the relevant valve fully open, check the clearances of the two valves specified. The clearances are checked by inserting a feeler blade of the correct thickness between the valve stem and the rocker arm adjusting screw. The feeler blade should be a light, sliding fit. If adjustment is necessary, slacken the adjusting screw locknut, and turn the screw as necessary (see illustration). Once the correct clearance is obtained, hold the adjusting screw and tighten the locknut securely. Once the locknut has been tightened, recheck the valve clearance, and adjust again if necessary.

6 Rotate the crankshaft until the next valve in the sequence is fully open, and check the clearances of the next two specified valves.

7 Repeat the procedure until all eight valve clearances have been checked (and if necessary, adjusted), then refit the cylinder head cover as described in Section 4.

## 10 Camshaft(s) and rocker arms/followers – removal, inspection and refitting

### General information

1 On 1.6 litre engines, the valves are operated by followers incorporating hydraulic compensator units, between the camshafts and the top of the valves. On 1.4 litre engines, the valves are operated by rocker arms between the camshaft and the top of the valves. The rocker arm assembly is secured to the top of the cylinder head by the cylinder head bolts. Although in theory it is possible to undo the head bolts and remove the rocker arm assembly without removing the head, in practice, this is not recommended. Once the

bolts have been removed, the head gasket will be disturbed, and the gasket will almost certainly leak or blow after refitting. For this reason, removal of the rocker arm assembly cannot be done without removing the cylinder head and renewing the head gasket.

2 On 1.6 litre engines, the camshafts can be removed upwards from the cylinder head. On 1.4 litre engines, the camshaft is slid out of the right-hand end of the cylinder head, and it therefore cannot be removed without first removing the cylinder head, due to a lack of clearance.

### Removal

#### Rocker arms – 1.4 litre engines

3 Remove the cylinder head as described in Section 11.

4 To dismantle the rocker arm assembly, carefully prise off the circlip from the right-hand end of the rocker shaft; retain the rocker pedestal, to prevent it being sprung off the end of the shaft. Slide the various components off the end of the shaft, keeping all components in their correct fitted order (see illustration). Make a note of each component's correct fitted position and orientation as it is removed, to ensure it is fitted correctly on reassembly.

**Note:** Avoid touching the rocker arm roller bearing surfaces with your fingers.

5 To separate the left-hand pedestal and shaft, first unscrew the cylinder head cover retaining stud from the top of the pedestal; this can be achieved using a stud extractor, or two nuts locked together (see illustration). With the stud removed, unscrew the grub screw from the top of the pedestal, and withdraw the rocker shaft.

#### Camshaft – 1.4 litre engines

6 Remove the cylinder head as described in Section 11.

7 With the head on a bench, remove the locking tool, then remove the camshaft sprocket as described in Section 7.

8 On early models, remove the ignition coil module from the left-hand end of the cylinder head (see Chapter 5B) then undo the bolts and remove the coil mounting bracket. On later models, unbolt the coolant housing from the left-hand end of the cylinder head.

9 Undo the retaining bolt and slide out the camshaft thrust fork (see illustration).

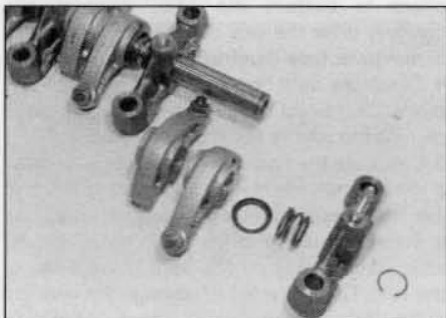

10.4 Remove the circlip and slide the components from the rocker shaft – 1.4 litre engines

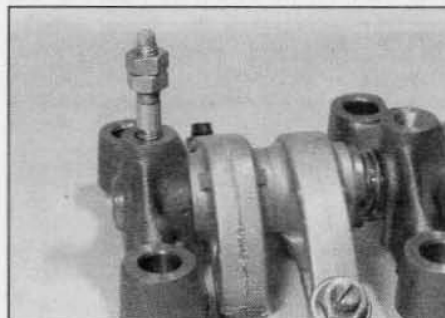

10.5 Lock two nuts together to enable the stud to be unscrewed from the left-hand end pedestal – 1.4 litre engines

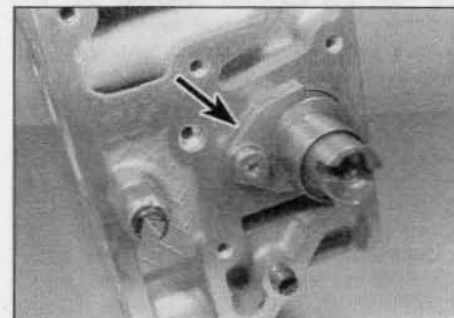

10.9 Undo the bolt and slide out the camshaft thrust fork (arrowed) – 1.4 litre engines



10 Note the fitted depth of the camshaft oil seal in relation to the cylinder head face as a guide for refitting. Using a large flat-bladed screwdriver, carefully prise the oil seal out of the right-hand end of the cylinder head, then slide out the camshaft (see illustrations).

#### Camshafts/followers – 1.6 litre engines

11 Remove the camshaft sprockets as described in Section 7, then remove the timing belt inner cover as described in Section 5.

12 Starting from the outside, working in a spiral pattern, progressively and evenly slacken the camshaft bearing housing retaining bolts, and lift the housing from the cylinder head (see illustration).

13 Identify each camshaft for position – the inlet camshaft is at the rear and the exhaust camshaft is at the front of the cylinder head. Also note the TDC position of each camshaft for correct refitting.

14 Remove the camshafts by pressing on the transmission ends to release the opposite ends from their bearings. Withdrawn the camshafts from the cylinder head and slide the oil seals from the ends.

15 Obtain 16 small, clean plastic containers, and number them inlet 1 to 8 and exhaust 1 to 8; alternatively, divide a larger container into 16 compartments and number each compartment accordingly. Using a rubber sucker, withdraw each follower in turn, and place it in its respective container. Don't interchange the followers, the wear rate will be much increased.

#### Inspection

##### Rocker arm assembly

16 Examine the rocker arm roller surfaces which contact the camshaft lobes for wear ridges and scoring. Renew any rocker arms on which the rollers show signs of damage. If a rocker arm roller surface is badly scored, also examine the corresponding lobe on the camshaft for wear, as both will likely be worn. Renew worn components as necessary. The rocker arm assembly can be dismantled as described in paragraphs 4 and 5.

17 Inspect the ends of the (valve clearance)

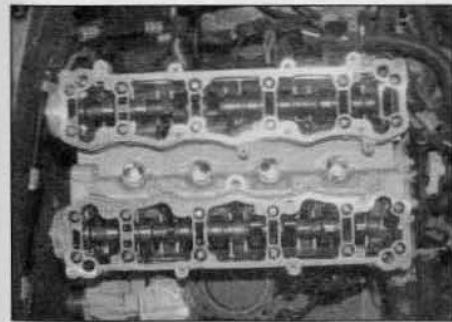

10.12 Evenly and progressively slacken the camshaft housing retaining bolts – 1.6 litre engines



10.10a Prise out the oil seal . . .

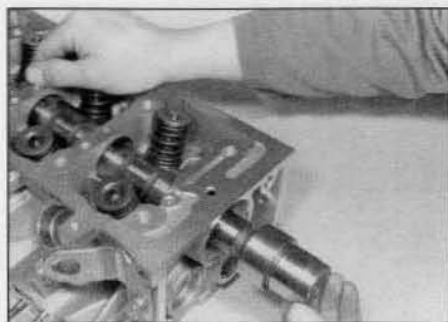

10.10b . . . then slide out the camshaft from the cylinder head – 1.4 litre engines

adjusting screws for signs of wear or damage, and renew as required.

18 If the rocker arm assembly has been dismantled, examine the rocker arm and shaft bearing surfaces for wear ridges and scoring. If there are obvious signs of wear, the relevant rocker arm(s) and/or the shaft must be renewed.

#### Camshaft(s)

19 Examine the camshaft bearing surfaces and cam lobes for signs of wear ridges and scoring. Renew the camshaft if any of these conditions are apparent. Examine the condition of the bearing surfaces, both on the camshaft journals and in the cylinder head/bearing housing. If the head bearing surfaces are worn excessively, the cylinder head will need to be renewed.

20 On 1.4 litre engines, examine the thrust fork for signs of wear or scoring, and renew as necessary.

21 On 1.6 litre engines, examine the hydraulic follower surfaces which contact the camshaft lobes for wear ridges and scoring. Renew any follower where these conditions are apparent. If a follower bearing surface is badly scored, also examine the corresponding lobe on the camshaft for wear, as it is likely that both will be worn. Renew any components as necessary.

#### Refitting

##### Rocker arms – 1.4 litre engines

22 If the rocker arm assembly was dismantled, refit the rocker shaft to the left-hand pedestal, aligning its locating hole with the pedestal threaded hole. Refit the grub screw, and tighten it securely. With the grub screw in position, refit the cylinder head cover mounting stud to the pedestal, and tighten it securely. Apply a smear of clean engine oil to the shaft, then slide on all removed components, ensuring each is correctly fitted in its original position. **Note:** Avoid touching the rocker arm roller bearing surfaces with your fingers. Once all components are in position on the shaft, compress the right-hand pedestal and refit the circlip. Ensure that the circlip is correctly located in its groove on the shaft.

23 Refit the cylinder head and rocker arm assembly as described in Section 11.

#### Camshaft – 1.4 litre engines

24 Ensure that the cylinder head and camshaft bearing surfaces are clean, then liberally oil the camshaft bearings and lobes. Slide the camshaft back into position in the cylinder head.

25 Locate the thrust fork with the left-hand end of the camshaft. Refit the fork retaining bolt, tightening it to the specified torque setting.

26 On early models, refit the mounting bracket, then refit the ignition coil module with reference to Chapter 5B. On later models, ensure that the coolant housing and cylinder head mating surfaces are clean and dry, then apply a smear of sealant to the housing mating surface. Refit the housing to the cylinder head, and securely tighten its retaining bolts.

27 Lubricate the lips of the new seal with clean engine oil, then drive it into position until it is at the fitted depth noted during removal. Use a suitable tubular drift, such as a socket, which bears only on the hard outer edge of the seal. Take care not to damage the seal lips during fitting. Note that the seal lips should face inwards.

28 Refit the camshaft sprocket as described in Section 7.

29 Refit the cylinder head as described in Section 11.

#### Camshafts/followers – 1.6 litre engines

30 Before commencing refitting, remove all traces of oil from the bearing housing retaining bolts holes in the cylinder head, using a clean rag. Also ensure that both the cylinder head and bearing housing mating faces are clean and free from oil.

31 Liberally oil the cylinder head hydraulic follower bores and the followers. Carefully refit the followers to the cylinder head, ensuring that each follower is refitted to its original bore. Some care will be required to enter the followers squarely into their bores. Check that each follower rotates freely.

32 Liberally oil the camshaft bearings in the cylinder head and the camshaft lobes, then refit the camshafts to the cylinder head in the previously noted positions. The locating notch in the right-hand end of the camshafts should

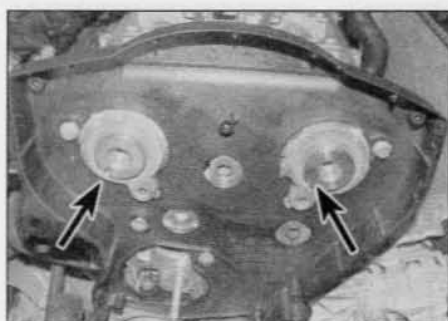

**10.32** Position the inlet camshaft locking notch at the 7 o'clock position and the exhaust camshaft at 8 o'clock (arrowed) – 1.6 litre engines

be positioned at the 7 o'clock position on the inlet camshaft, and the 8 o'clock position on the exhaust camshaft (see illustration).

**33** Apply a bead of silicone-based jointing compound around the perimeter of the mating faces and around the retaining bolt hole locations (see illustration).

**34** Refit the bearing housing, and tighten the bolts progressively, in sequence, to the specified torque (see illustration).

**35** Fit new oil seals with reference to Section 8.

**36** Refit the timing belt inner cover as described in Section 5.

**37** Refit the camshaft sprockets as described in Section 7.

## 11 Cylinder head – removal and refitting

**Note:** Ensure the engine is cold before removing the cylinder head.

### Removal

**1** Disconnect the battery negative terminal (refer to *Disconnecting the battery* in the Reference Chapter).

**2** Drain the cooling system as described in Chapter 1A.

**3** Remove the ignition coil assembly (see Chapter 5B) then remove the spark plugs (see Chapter 1A).

**4** Remove the cylinder head cover(s) as described in Section 4.

**5** Remove the timing belt upper and lower covers as described in Section 5.

**6** Align the engine assembly/valve timing holes as described in Section 3, and lock both the camshaft sprocket(s) and flywheel in position.

**Caution:** Do not attempt to rotate the engine whilst the tools are in position.

### 1.4 litre engines

**7** Note that the following text assumes that the cylinder head will be removed with both inlet and exhaust manifolds attached; this is easier, but makes it a bulky and heavy assembly to handle. If it is wished to remove

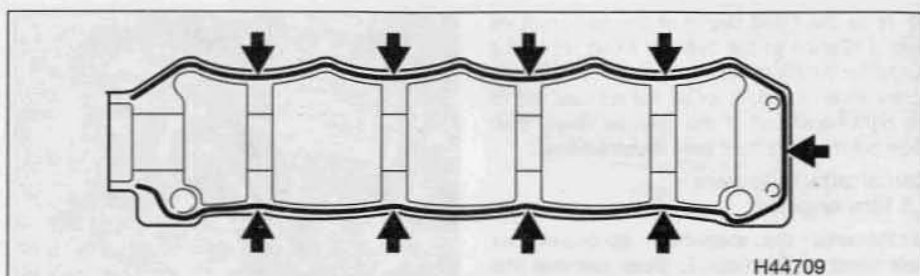

**10.33** Apply a bead of silicone sealant to the cylinder head mating surface (arrowed) – 1.6 litre engines

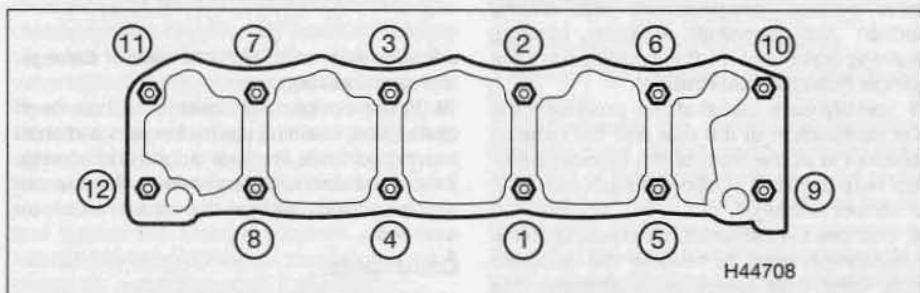

**10.34** Camshaft bearing housing bolts tightening sequence – 1.6 litre engines

the manifolds first, proceed as described in Chapter 4A.

**8** Carry out the following operations as described in Chapter 4A:

- Remove the air cleaner assembly and air intake ducting.
- Disconnect the exhaust system front pipe from the manifold and from the bracket on the transmission. Disconnect or release the oxygen sensor wiring.
- Disconnect the fuel feed hose (and, where applicable, the return hose) from the fuel rail (plug all openings, to prevent loss of fuel and entry of dirt into the fuel system).
- Note their fitted positions, then disconnect the relevant electrical connectors and vacuum/breather hoses from the inlet manifold and throttle housing.
- Where necessary unbolt the support bracket from the inlet manifold.
- Disconnect the accelerator cable (where fitted).
- On models with air injection, disconnect the hose from the injection valve which is fitted to the exhaust manifold.

**9** Note their fitted positions, then slacken the retaining clips, and disconnect the coolant hoses from the cylinder head. Likewise, note the routing, then disconnect all electrical connectors from the cylinder head.

**10** Slacken and remove the bolt securing the engine oil dipstick tube to the cylinder head.

**11** On later models with power steering, referring to Chapter 10, unbolt the power steering pump from its mounting bracket. Undo the power steering pipe retaining clip screws then position the pump clear of the engine. Support the weight of the pump by

tying it to the vehicle body to prevent any excess strain being placed on the hydraulic pipes/hoses. **Note:** There is no need to disconnect the pipe/hose from the pump.

**12** Loosen the timing belt tensioner pulley retaining nut. Pivot the pulley approximately 60° in a clockwise direction, using a key fitted to the hole in the pulley hub, then retighten the retaining nut. On early engines, an 8 mm square section key will be required, and on later engines with an automatic tensioner, an Allen key will be needed.

**13** Disengage the timing belt from the camshaft sprocket, and position the belt clear of the sprocket. Ensure that the belt is not bent or twisted sharply.

**14** Working in the reverse of the tightening sequence (see illustration 11.39a), progressively slacken the cylinder head bolts by half a turn at a time, until all bolts can be unscrewed by hand (see illustration).

**15** With all the cylinder head bolts removed, lift the rocker arm assembly off the cylinder



**11.14** Slacken and remove the cylinder head bolts – 1.4 litre engines





**11.15** Lift off the rocker arm assembly – 1.4 litre engines

head (see illustration). **Note:** Avoid touching the rocker arm roller bearing surfaces with your fingers. Note the locating pins which are fitted to the base of each rocker arm pedestal. If any pin is a loose fit in the head or pedestal, remove it for safe-keeping.

**16** The joint between the cylinder head and gasket, and the cylinder block/crankcase must now be broken without disturbing the wet liners. To break the joint, obtain two stout screwdrivers which fit into the cylinder head bolt holes. Gently 'rock' the cylinder head free towards the front of the car (see illustration). Do not try to swivel the head on the cylinder block/crankcase; it is located by dowels, as well as by the tops of the liners. **Note:** If care is not taken and the liners are moved, there is also a possibility of the bottom seals being disturbed, causing leakage after refitting the head. When the joint is broken, lift the cylinder head away; seek assistance if possible, as it is a heavy assembly, especially if it is being removed complete with the manifolds.

**17** Remove the gasket from the top of the block, noting the two locating dowels. If the locating dowels are a loose fit, remove them and store them with the head for safe-keeping. Do not discard the gasket – it will be needed for identification purposes (see paragraphs 29 and 30). Operations that require the rotation of the crankshaft (eg, cleaning the piston crowns), should only be carried out once the cylinder liners are firmly clamped in position (see illustration). In the absence of the manufacturer's special liner clamps, the liners can be clamped in position using large flat washers positioned underneath suitable-length bolts. Alternatively, the original head bolts could be temporarily refitted, with suitable spacers fitted to their shanks.

**18** If the cylinder head is to be dismantled for overhaul, remove the camshaft as described in Section 10, then refer to Part D of this Chapter.

#### 1.6 litre engines

**19** Note their fitted positions, then slacken the retaining clips, and disconnect the coolant hoses from the cylinder head. Likewise, note the routing, then disconnect all electrical connectors from the cylinder head.

**20** Remove the inlet and exhaust manifolds as described in Chapter 4A.



**11.16** Use two stout screwdrivers to rock the cylinder head free from the block – 1.4 litre engines

**21** Remove the timing belt inner cover as described in Section 5.

**22** Working in the reverse of the tightening sequence (see illustration 11.39b), progressively slacken the cylinder head bolts by half a turn at a time, until all bolts can be unscrewed by hand.

**23** Lift the cylinder head away; seek assistance if possible, as it is a heavy assembly.

**24** Remove the gasket from the top of the block, noting the two locating dowels. If the locating dowels are a loose fit, remove them and store them with the head for safe-keeping. Do not discard the gasket – it will be needed for identification purposes (see paragraphs 29 and 30).

**25** If the cylinder head is to be dismantled for overhaul, remove the camshafts as described in Section 10, then refer to Part D of this Chapter.

#### Preparation for refitting

**26** The mating faces of the cylinder head and cylinder block/crankcase must be perfectly clean before refitting the head. Use a hard plastic or wood scraper to remove all traces of gasket and carbon; also clean the piston crowns. **Note:** On 1.4 litre engines, clamp the liners in position before turning the crankshaft (see paragraph 17). Take particular care during the cleaning operations, as aluminium alloy is easily damaged. Also, make sure that the carbon is not allowed to enter the oil and water passages – this is particularly important for the lubrication system, as carbon could block the oil supply to the engine's components. Using adhesive tape and paper, seal the water, oil and bolt holes in the cylinder block/crankcase. To prevent carbon entering the gap between the pistons and bores, smear a little grease in the gap. After cleaning each piston, use a small brush to remove all traces of grease and carbon from the gap, then wipe away the remainder with a clean rag. Clean all the pistons in the same way.

**27** Check the mating surfaces of the cylinder block/crankcase and the cylinder head for nicks, deep scratches and other damage. If slight, they may be removed carefully with a file, but if excessive, machining may be the only alternative to renewal.

**28** If warpage of the cylinder head gasket surface is suspected, use a straight-edge to



**11.17** Clamp the cylinder liners in position before rotating the crankshaft (clamps arrowed) – 1.4 litre engines

check it for distortion. Refer to Part D of this Chapter if necessary.

**29** When purchasing a new cylinder head gasket, it is essential that a gasket of the correct thickness is obtained. On some models only one thickness of gasket is available, so this is not a problem. On other models, there are two different thicknesses available – the standard gasket, and a slightly thicker 'repair' gasket (+ 0.2 mm). The gaskets can be identified as described in the following paragraph, using the cut-outs on the left-hand end of the gasket.

**30** With the gasket fitted the correct way up on the cylinder block, there will be a single or double cut-out at the rear of the left-hand side of the gasket identifying the engine type (eg, TU3JP engine). In the centre of the gasket there will likely be another series of between 0 and 4 cut-outs, identifying the manufacturer of the gasket and whether or not it contains asbestos (these cut-outs are of little importance). The important cut-out location is at the front of the gasket; on the standard gasket there will be no cut-out in this position, whereas on the thicker 'repair' gasket there will be a single cut-out (see illustration).

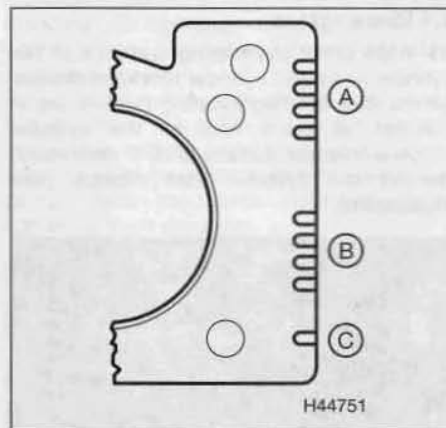

**11.30** Cylinder head gasket identification markings

- A Engine type identification cut-out locations
- B Gasket manufacturer identification cut-out locations
- C Gasket thickness identification cut-out locations



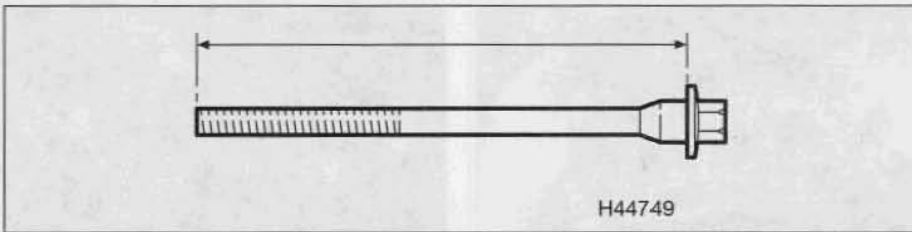

11.31 Measure the bolt length from the underside of the bolt head to the end of the bolt

Identify the gasket type, and ensure that the new gasket obtained is of the correct thickness. If there is any doubt as to which gasket is fitted, take the old gasket along to your dealer, and have him confirm the gasket type.

31 Check the condition of the cylinder head bolts, and particularly their threads, whenever they are removed. Wash the bolts in suitable solvent, and wipe them dry. Check each for any sign of visible wear or damage, renewing any bolt if necessary. Measure the length of each bolt, from the underside of its head to the bolt end, to check for stretching (see illustration). The bolts for 1.4 litre engines are 175.5 mm in length when new; if any bolt has stretched to more than 176.5 mm, renew all the cylinder head bolts as a set. On 1.6 litre engines, the maximum length for the bolts is 122.6 mm. Although the manufacturer's do not actually specify that the bolts must be renewed, it is strongly recommended that the bolts should be renewed as a complete set, regardless of their apparent condition, whenever they are disturbed.

32 On 1.4 litre engines, prior to refitting the cylinder head, check the cylinder liner protrusion as described Chapter 2D, Section 11.

**Refitting**

**1.4 litre engines**

33 Wipe clean the mating surfaces of the cylinder head and cylinder block/crankcase. Check that the two locating dowels are in position at each end of the cylinder block/crankcase surface and, if necessary, remove the cylinder liner clamps (see illustration).

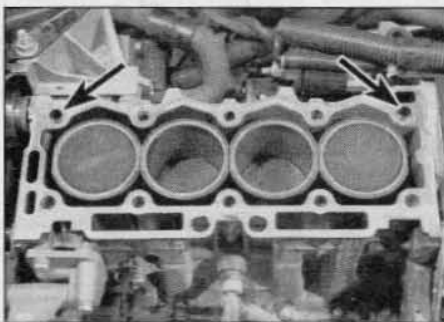

11.33 Ensure the locating dowels (arrowed) are in position then fit the new head gasket

34 Position a new gasket on the cylinder block/crankcase surface, ensuring that its identification cut-outs are at the left-hand end of the gasket, and the side marked TOP is uppermost.

35 Check that the flywheel and camshaft sprocket are still correctly locked in position with their respective tools then, with the aid of an assistant, carefully refit the cylinder head assembly to the block, aligning it with the locating dowels.

36 Ensure that the locating pins are in position in the base of each rocker pedestal, then refit the rocker arm assembly to the cylinder head.

37 Lubricate the threads and underside of the heads of the cylinder head bolts lightly with clean engine oil.

38 Carefully enter each bolt into its relevant hole (do not drop them in) and screw in, by hand only, until finger-tight.

39 Working progressively and in sequence, tighten the cylinder head bolts to their Stage 1 torque setting, using a torque wrench and suitable socket (see illustrations).

40 Once all the bolts have been tightened to their Stage 1 setting, working again in the given sequence, angle-tighten the bolts through the specified Stage 2 angle, using a socket and extension bar. It is recommended that an angle-measuring gauge is used during this stage of the tightening, to ensure accuracy. If a gauge is not available, use white paint to make alignment marks between the bolt head and cylinder head prior to tightening; the marks can then be used to check that the bolt has been rotated through the correct angle during tightening.

41 Refit the timing belt as described in Section 6.

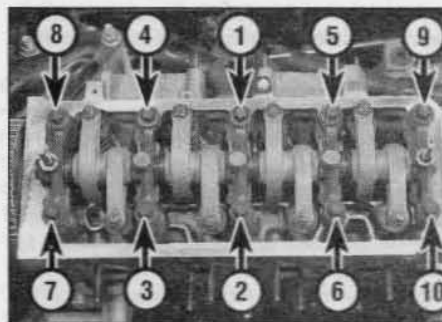

11.39a Cylinder head bolt tightening sequence - 1.4 litre engines

42 Reconnect all coolant hoses and wiring connectors to the cylinder head, inlet manifold and throttle housing.

43 Refit the bolt securing the engine oil dipstick tube to the cylinder head.

44 Working as described in the Chapter 4A, carry out the following tasks:

- a) Refit all disturbed fuel hoses and control cable(s) to the inlet manifold and fuel system components.
- b) Reconnect and adjust the accelerator cable (where fitted).
- c) Reconnect the exhaust system front pipe to the manifold and transmission bracket and reconnect the oxygen sensor wiring connector.
- d) Refit the air cleaner assembly and intake ducts.

45 Check and, if necessary, adjust the valve clearances as described in Section 9.

46 Refit the cylinder head cover as described in Section 4.

47 Refit the spark plugs and install the ignition HT coil (see Chapters 1A and 5B).

48 Refit the power steering pump as described in Chapter 10.

49 On completion, reconnect the battery, and refill the cooling system as described in Chapter 1A.

**1.6 litre engines**

50 Remove the flywheel locking tool and, using a spanner or socket on the crankshaft pulley bolt, rotate the crankshaft backwards (anti-clockwise) 90°. This is to prevent any accidental contact between the pistons and valves as the cylinder head is refitted.

51 Check that the camshafts are correctly positioned in the cylinder head. The locating notch in the right-hand end of the camshafts should be at the 7 o'clock position on the inlet camshaft, and the 8 o'clock position on the exhaust camshaft (see illustration 10.32). If necessary, reposition the camshafts using an open-ended spanner on the square section between the lobes.

52 Wipe clean the mating surfaces of the cylinder head and cylinder block/crankcase. Check that the two locating dowels are in position at each end of the cylinder block/crankcase surface.

53 Position a new gasket on the cylinder

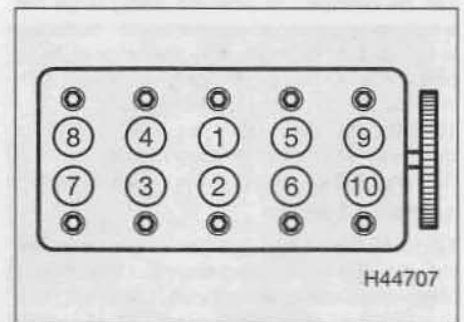

11.39b Cylinder head bolt tightening sequence - 1.6 litre engines

block/crankcase surface, ensuring that its identification cut-outs are at the left-hand end of the gasket, and the side marked TOP is uppermost.

**54** Lubricate the threads and underside of the heads of the cylinder head bolts lightly with clean engine oil, then refit and tighten the bolts as described in paragraphs 38 to 40.

**55** Refit the timing belt inner cover as described in Section 5, then refit the camshaft sprockets as described in Section 7.

**56** Refit the timing belt as described in Section 6.

**57** Working as described in the Chapter 4A, carry out the following tasks:

- Refit the inlet and exhaust manifolds.
- Refit all disturbed fuel hoses and control cable(s) to the inlet manifold and fuel system components.
- Refit the air cleaner assembly and intake ducts.

**58** Reconnect all coolant hoses and wiring connectors to the cylinder head, inlet manifold and throttle housing.

**59** Refit the cylinder head covers as described in Section 4.

**60** Refit the spark plugs and install the ignition HT coil (see Chapters 1A and 5B).

**61** On completion, reconnect the battery, and refill the cooling system as described in Chapter 1A.

## 12 Sump – removal and refitting

### Removal

**1** Firmly apply the handbrake, then jack up the front of the vehicle and support it on axle stands (see *Jacking and vehicle support*). Where fitted, undo the screws and remove the engine undershield.

**2** Drain the engine oil, then clean and refit the engine oil drain plug, tightening it to the specified torque. If the engine is nearing its service interval when the oil and filter are due for renewal, it is recommended that the filter is also removed, and a new one fitted. After reassembly, the engine can then be refilled with fresh oil. Refer to Chapter 1A for further information.

**3** Remove the exhaust system front pipe as described in Chapter 4A.

**4** Progressively slacken and remove all the sump nuts and bolts/nuts and position the wiring harness guide clear of the sump (see illustrations).

**5** Break the joint by striking the sump with the palm of your hand, then lower and withdraw the sump from under the car. On 1.4 litre engines, it may be necessary to use a putty knife or similar carefully inserted between the sump and block. Ease the knife along the joint until the sump is released. On 1.6 litre engines, recover the gasket.

**6** While the sump is removed, take the

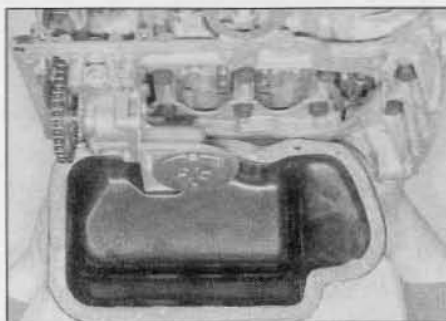

**12.4a** Undo the nuts and bolts, then remove the sump from the engine – 1.4 litre engines

opportunity to check the oil pump pick-up/strainer for signs of clogging or splitting. If necessary, remove the pump as described in Section 13, and clean or renew the strainer.

### Refitting

**7** Clean all traces of sealant from the mating surfaces of the cylinder block/crankcase and sump, then use a clean rag to wipe out the sump and the engine's interior.

**8** Ensure that the sump and cylinder block/crankcase mating surfaces are clean and dry then, on 1.4 litre engines, apply a coating of suitable sealant to the sump mating surface. On 1.6 litre engines, if the gasket is undamaged, refit it to the sump, otherwise fit a new gasket.

**9** Offer up the sump and locate it on its studs. Locate the wiring harness guide back in position then refit the sump retaining nuts and bolts. Tighten the nuts and bolts evenly and progressively to the specified torque.

**10** Refit the exhaust front pipe as described in Chapter 4A, and refit the engine undershield (where applicable).

**11** Replenish the engine oil (see Chapter 1A).

## 13 Oil pump – removal, inspection and refitting

### Removal

**1** Remove the sump (see Section 12).

**2** Slacken and remove the three bolts securing the oil pump in position (see illustration). Disengage the pump sprocket from the chain, and remove the oil pump. If the pump locating dowel is a loose fit, remove and store it with the bolts for safe-keeping.

### Inspection

**3** Examine the oil pump sprocket for signs of damage and wear, such as chipped or missing teeth. If the sprocket is worn, the pump assembly must be renewed, as the sprocket is not available separately. It is also recommended that the chain and drive sprocket, fitted to the crankshaft, are renewed at the same time. On 1.4 litre engines, renewal of the chain and drive sprocket is an involved

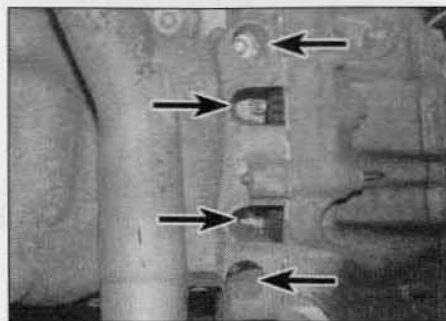

**12.4b** Access to the sump end bolts/nuts is through holes in the casing (arrowed) – 1.6 litre engines

operation requiring the removal of the main bearing ladder, and therefore cannot be carried out with the engine still fitted to the vehicle. On 1.6 litre engines, the oil pump drive sprocket and chain can be removed with the engine *in situ*, once the crankshaft sprocket has been removed and the crankshaft oil seal housing has been unbolted.

**4** Slacken and remove the bolts securing the strainer cover to the pump body, then lift off the strainer cover. Remove the relief valve piston and spring (and guide pin – 1.6 litre engines only), noting which way round they are fitted.

**5** Examine the pump rotors and body for signs of wear ridges and scoring. If worn, the complete pump assembly must be renewed.

**6** Examine the relief valve piston for signs of wear or damage, and renew if necessary. The condition of the relief valve spring can only be measured by comparing it with a new one; if there is any doubt about its condition, it should also be renewed. Both the piston and spring are available individually.

**7** Thoroughly clean the oil pump strainer with a suitable solvent, and check it for signs of clogging or splitting. If the strainer is damaged, the strainer and cover assembly must be renewed.

**8** Locate the relief valve spring, piston and (where fitted) the guide pin in the strainer cover, then refit the cover to the pump body. Align the relief valve piston with its bore in the pump. Refit the cover retaining bolts, tightening them securely.

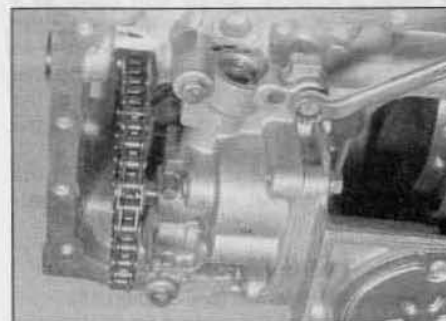

**13.2** Unscrew the three bolts securing the oil pump in position



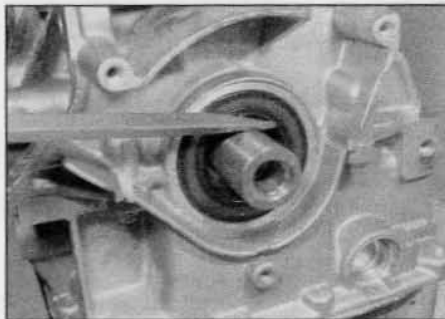

14.2 Use a screwdriver to lever out the crankshaft right-hand oil seal

### Refitting

9 Ensure that the locating dowel is in position, then engage the pump sprocket with its drive chain. Locate the pump on its dowel, and refit the pump retaining bolts, tightening them to the specified torque setting.

10 Refit the sump as described in Section 12.

### 14 Crankshaft oil seals – renewal



### Right-hand oil seal

1 Remove the crankshaft sprocket and flanged spacer (where fitted) as described in Section 7.

2 Make a note of the correct fitted depth of the seal in its housing then carefully punch or drill two small holes opposite each other in the seal. Screw a self-tapping screw into each, and pull on the screws with pliers to extract the seal. Alternatively, the seal can be levered out of position using a suitable flat-bladed screwdriver, taking great care not to damage the crankshaft/oil pump drive gear shoulder or seal housing (see illustration).

3 Clean the seal housing, and polish off any burrs or raised edges, which may have caused the seal to fail in the first place.

4 Lubricate the lips of the new seal with clean engine oil, and carefully locate the seal on the end of crankshaft. Note that its sealing lip must face inwards. Take care not to damage the seal lips during fitting.

5 Using a suitable tubular drift (such as a socket) which bears only on the hard outer edge of the seal, tap the seal into position, to the same depth in the housing as the original was prior to removal. The inner face of the seal must be flush with the inner wall of the crankcase.

6 Wash off any traces of oil, then refit the crankshaft sprocket as described in Section 7.

### Left-hand oil seal

7 Remove the flywheel (see Section 15).

8 Make a note of the correct fitted depth of the seal in its housing. Punch or drill two small holes opposite each other in the seal. Screw a

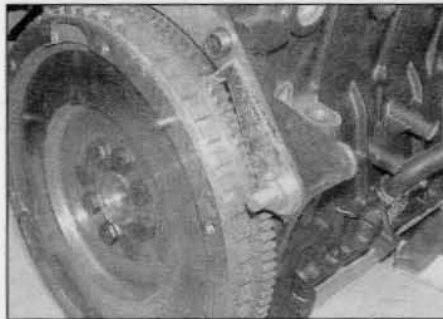

15.2 Use a tool to lock the flywheel ring gear and prevent rotation

self-tapping screw into each, and pull on the screws with pliers to extract the seal.

9 Clean the seal housing, and polish off any burrs or raised edges, which may have caused the seal to fail in the first place.

10 Lubricate the lips of the new seal with clean engine oil, and carefully locate the seal on the end of the crankshaft.

11 Using a suitable tubular drift, which bears only on the hard outer edge of the seal, drive the seal into position, to the same depth in the housing as the original was prior to removal.

12 Wash off any traces of oil, then refit the flywheel as described in Section 15.

### 15 Flywheel – removal, inspection and refitting



### Removal

1 Remove the transmission as described in Chapter 7, then remove the clutch assembly as described in Chapter 6.

2 Prevent the flywheel from turning by locking the ring gear teeth (see illustration). Alternatively, bolt a strap between the flywheel and the cylinder block/crankcase.

**Caution: Do not attempt to lock the flywheel in position using the locking pin described in Section 3.**

3 Slacken and remove the flywheel retaining bolts.

4 Remove the flywheel. Do not drop it, as it is very heavy. If the locating dowel is a loose fit in the crankshaft end, remove and store it with the flywheel for safe-keeping.

### Inspection

5 If the flywheel's clutch mating surface is deeply scored, cracked or otherwise damaged, the flywheel must be renewed. However, it may be possible to have it surface-ground; seek the advice of a dealer or engine reconditioning specialist.

6 If the ring gear is badly worn or has missing teeth, it must be renewed. This job is best left to a dealer or engine reconditioning specialist. The temperature to which the new ring gear must be heated for installation is critical and, if not done accurately, the hardness of the teeth will be destroyed.

### Refitting

7 Clean the mating surfaces of the flywheel and crankshaft.

8 If the new flywheel retaining bolts are not supplied with their threads already pre-coated, apply a suitable thread-locking compound to the threads of each bolt.

9 Ensure that the locating dowel is in position. Offer up the flywheel, locating it on the dowel, and fit the retaining bolts.

10 Lock the flywheel using the method employed on dismantling, and tighten the retaining bolts evenly and progressively to the specified torque.

11 Refit the clutch as described in Chapter 6. Remove the locking tool, and refit the transmission as described in Chapter 7.

### 16 Engine/transmission mountings – inspection and renewal



### Inspection

1 If improved access is required, raise the front of the car and support it on axle stands (see *Jacking and vehicle support*).

2 Check the mounting rubber to see if it is cracked, hardened or separated from the metal at any point; renew the mounting if any such damage or deterioration is evident.

3 Check that all the mounting's fasteners are securely tightened; use a torque wrench to check if possible (see illustrations).

4 Using a large screwdriver or a crowbar, check for wear in the mounting by carefully levering against it to check for free play. Where this is not possible, enlist the aid of an assistant to move the engine/transmission back-and-forth, or from side-to-side, while you watch the mounting. While some free play is to be expected even from new components, excessive wear should be obvious. If excessive free play is found, check first that the fasteners are secure, then renew any worn components as described below.

### Renewal

#### Right-hand mounting – 1.4 litre engines

**Note:** The construction of the right-hand mounting differs slightly between early and later models, however the removal and refitting procedures are similar for both types.

5 Place a jack beneath the engine, with a block of wood on the jack head. Raise the jack until it is supporting the weight of the engine.

6 Release the wiring harness and/or vacuum hoses from the clips on the right-hand engine mounting upper bracket.

7 Slacken and remove the three nuts securing the upper bracket to the bracket on the cylinder block.

8 On later models, undo the bolt securing the



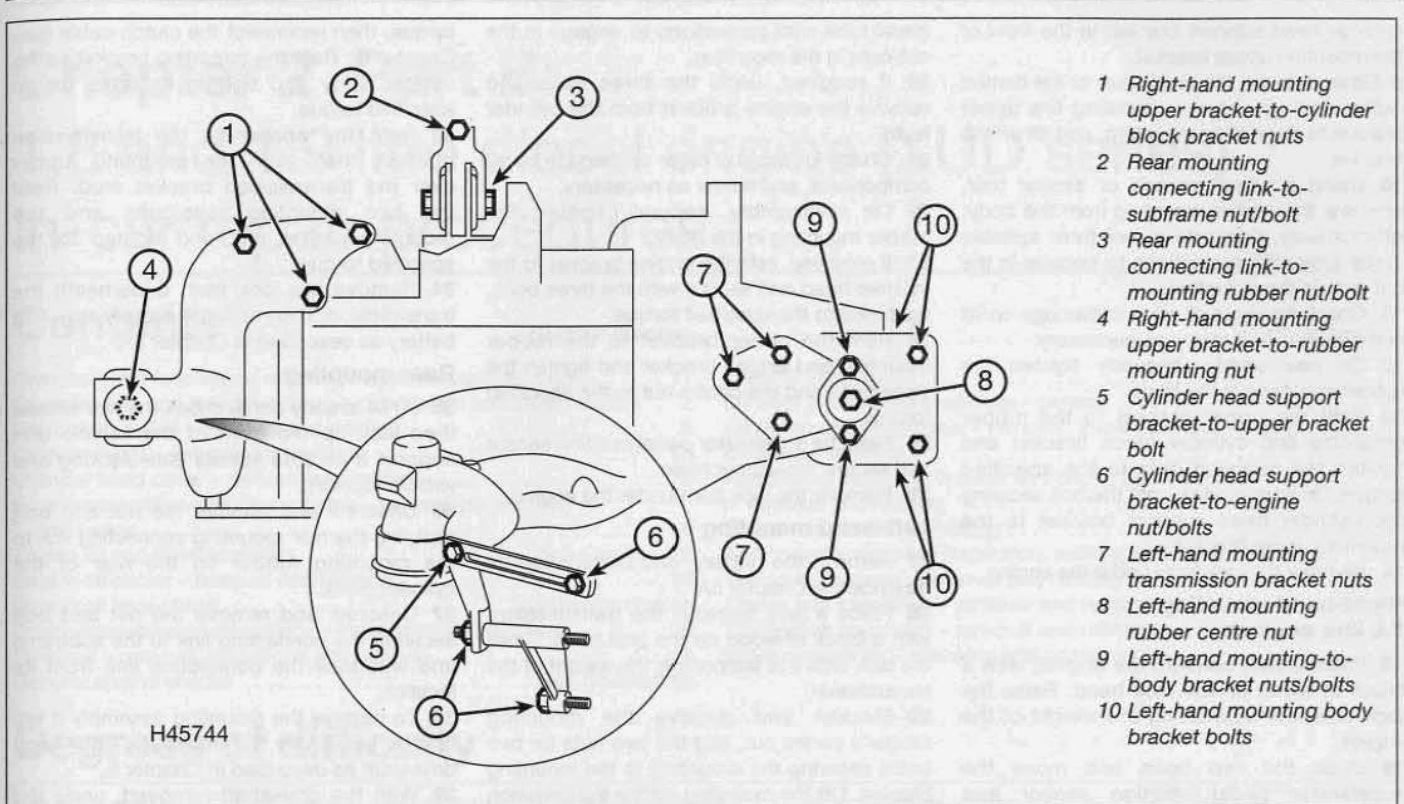

16.3a Engine/transmission mounting components and attachments - later 1.4 litre engines

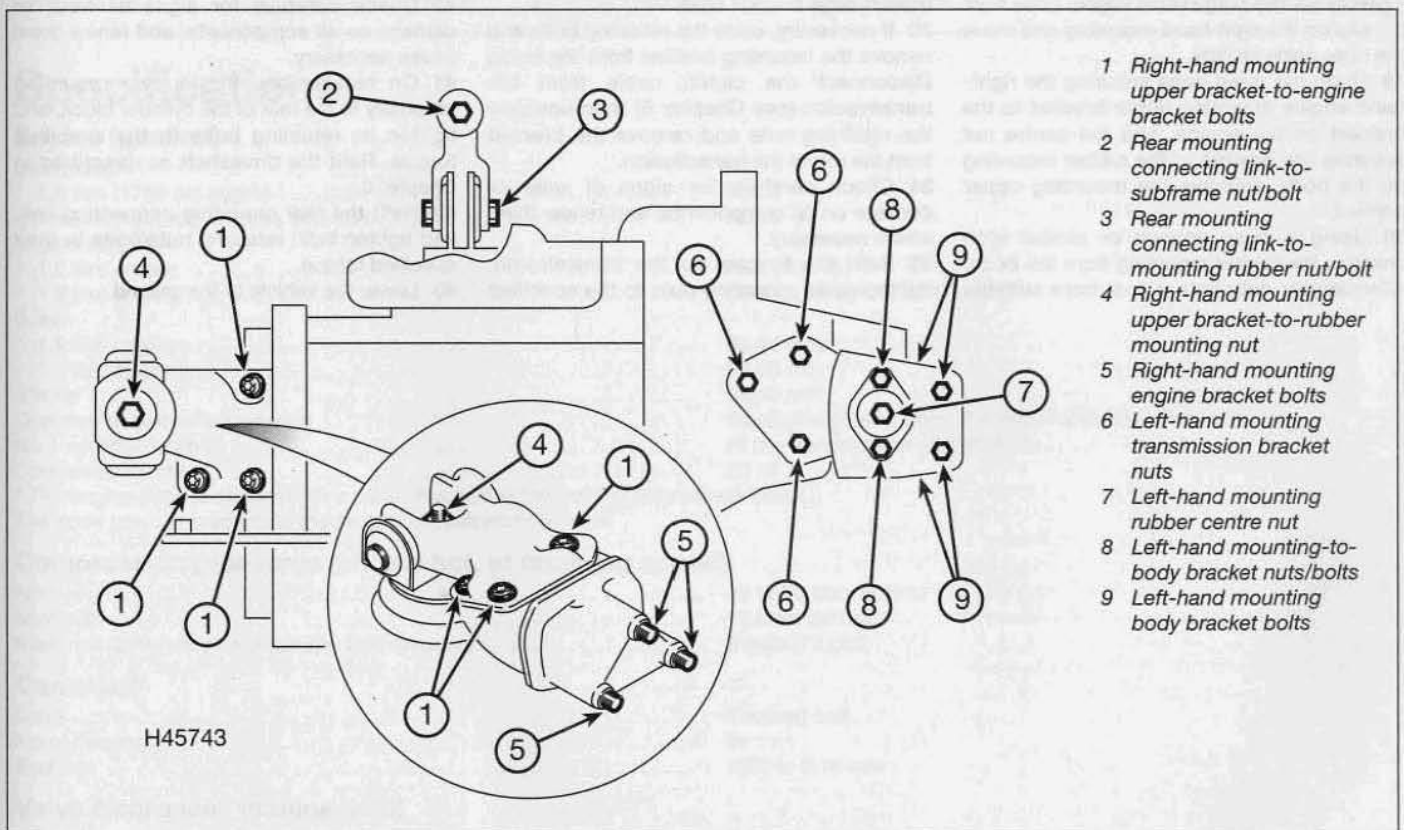

16.3b Engine/transmission mounting components and attachments - 1.6 litre engines

cylinder head support bracket to the front of the mounting upper bracket.

**9** Either unscrew the single nut, or the domed buffer and spacer nut, securing the upper bracket to the rubber mounting, and lift off the bracket.

**10** Using a strap wrench or similar tool, unscrew the rubber mounting from the body. Alternatively, fabricate a tool from suitable metal tube with projections to engage in the cut-outs in the mounting.

**11** Check for signs of wear or damage on all components, and renew as necessary.

**12** On reassembly, securely tighten the rubber mounting in the body.

**13** Refit the upper bracket to the rubber mounting and cylinder block bracket and tighten the retaining nuts to the specified torque. On later models, refit the bolt securing the cylinder head support bracket to the mounting upper bracket.

**14** Remove the jack from under the engine.

#### **Right-hand mounting – 1.6 litre engines**

**15** Place a jack beneath the engine, with a block of wood on the jack head. Raise the jack until it is supporting the weight of the engine.

**16** Undo the two bolts and move the accelerator pedal position sensor and mounting bracket clear of the right-hand engine mounting.

**17** Release the purge valve vapour hose from the clip on the right-hand mounting and move the hose aside slightly.

**18** Undo the three bolts securing the right-hand engine mounting upper bracket to the bracket on the engine, and the centre nut securing the bracket to the rubber mounting on the body. Remove the mounting upper bracket.

**19** Using a strap wrench or similar tool, unscrew the rubber mounting from the body. Alternatively, fabricate a tool from suitable

metal tube with projections to engage in the cut-outs in the mounting.

**20** If required, undo the three bolts and remove the engine bracket from the cylinder head.

**21** Check for signs of wear or damage on all components, and renew as necessary.

**22** On reassembly, securely tighten the rubber mounting in the body.

**23** If removed, refit the engine bracket to the cylinder head and secure with the three bolts, tightened to the specified torque.

**24** Refit the upper bracket to the rubber mounting and engine bracket and tighten the three bolts and the centre nut to the specified torque.

**25** Refit the accelerator pedal position sensor and secure the vapour hose.

**26** Remove the jack from under the engine.

#### **Left-hand mounting**

**27** Remove the battery, and battery tray as described in Chapter 5A.

**28** Place a jack beneath the transmission, with a block of wood on the jack head. Raise the jack until it is supporting the weight of the transmission.

**29** Slacken and remove the mounting rubber's centre nut, and the two nuts (or two bolts) securing the mounting to the mounting bracket. Lift the mounting off the transmission bracket stud and remove it from the engine compartment. Recover the spacer from the transmission bracket stud.

**30** If necessary, undo the retaining bolts and remove the mounting bracket from the body. Disconnect the clutch cable from the transmission (see Chapter 6) then unscrew the retaining nuts and remove the bracket from the top of the transmission.

**31** Check carefully for signs of wear or damage on all components, and renew them where necessary.

**32** Refit the bracket to the transmission, tightening its mounting nuts to the specified

torque, then reconnect the clutch cable (see Chapter 6). Refit the mounting bracket to the vehicle body and tighten its bolts to the specified torque.

**33** Refit the spacer to the transmission bracket, then slide the mounting rubber over the transmission bracket stud. Refit the two mounting nuts/bolts and the mounting centre nut, and tighten to the specified torque.

**34** Remove the jack from underneath the transmission, then refit the battery tray and battery as described in Chapter 5A.

#### **Rear mounting**

**35** If not already done, chock the rear wheels then jack up the front of the vehicle and support it on axle stands (see *Jacking and vehicle support*).

**36** Unscrew and remove the nut and bolt securing the rear mounting connecting link to the mounting rubber on the rear of the cylinder block.

**37** Unscrew and remove the nut and bolt securing the connecting link to the subframe and withdraw the connecting link from its location.

**38** To remove the mounting assembly it will first be necessary to remove the right-hand driveshaft as described in Chapter 8.

**39** With the driveshaft removed, undo the retaining bolts and remove the mounting from the rear of the cylinder block.

**40** Check carefully for signs of wear or damage on all components, and renew them where necessary.

**41** On reassembly, fit the rear mounting assembly to the rear of the cylinder block, and tighten its retaining bolts to the specified torque. Refit the driveshaft as described in Chapter 8.

**42** Refit the rear mounting connecting link, and tighten both retaining nuts/bolts to their specified torque.

**43** Lower the vehicle to the ground.

# Chapter 2 Part B:





## 1.8 and 1.9 litre diesel engine (XUD series)

### in-car repair procedures

## Contents

	Section number		Section number
Camshaft and followers – removal, inspection and refitting	11	General information	1
Compression and leakdown tests – description and interpretation	2	Oil level and pressure sensors – general	17
Crankshaft pulley – removal and refitting	5	Oil pump and drive chain – removal, inspection and refitting	15
Cylinder head – removal and refitting	13	Oil seals – renewal	16
Cylinder head cover – removal and refitting	4	Right-hand mounting bracket and timing belt tensioner – removal and refitting	9
Engine assembly/valve timing holes – general information and usage	3	Sump – removal and refitting	14
Engine oil and filter renewal	See Chapter 1B	Timing belt – removal, inspection, refitting and tensioning	7
Engine oil cooler – removal and refitting	19	Timing belt covers – removal and refitting	6
Engine oil level check	See <i>Weekly checks</i>	Timing belt idler roller – removal and refitting	10
Engine/transmission mountings – inspection and renewal	20	Timing belt sprockets – removal and refitting	8
Flywheel – removal, inspection and refitting	18	Valve clearances – checking and adjustment	12
General engine checks	See Chapter 1B		

## Degrees of difficulty

<b>Easy</b> , suitable for novice with little experience 	<b>Fairly easy</b> , suitable for beginner with some experience 	<b>Fairly difficult</b> , suitable for competent DIY mechanic 	<b>Difficult</b> , suitable for experienced DIY mechanic 	<b>Very difficult</b> , suitable for expert DIY or professional 
--	---	---	--	---

## Specifications

### Engine (general)

Designation:	
1.8 litre (1769 cc) engine	XUD7
1.9 litre (1905 cc) engines	XUD9
Engine codes*:	
1.8 litre engine	A9A (XUD7L)
1.9 litre engine	D9B (XUD9A) or DJY (XUD9Y)
Bore:	
1.8 litre engines	80.00 mm
1.9 litre engines	83.00 mm
Stroke	88.00 mm
Direction of crankshaft rotation	Clockwise (viewed from the right-hand side of vehicle)
No 1 cylinder location	At the transmission end of block
Compression ratio	23 : 1

\* The engine code is stamped on a plate attached to the front of the cylinder block.

The code given in brackets is the factory identification number.

### Compression pressures (engine hot, at cranking speed)

Normal	25 to 30 bars (363 to 435 psi)
Minimum	18 bars (261 psi)
Maximum difference between any two cylinders	5 bars (73 psi)

### Camshaft

Drive	Toothed belt
No of bearings	3
Endfloat	0.07 to 0.16 mm

### Valve clearances (engine cold)

Inlet	0.15 ± 0.05 mm
Exhaust	0.30 ± 0.05 mm



**Lubrication system**

Oil pump type .....	Gear-type, chain-driven off the crankshaft right-hand end
Minimum oil pressure at 90°C .....	3.5 bars at 4000 rpm
Oil pressure warning switch operating pressure .....	0.8 bars

**Torque wrench settings**

	Nm	lbf ft
Big-end bearing cap nuts:*		
Stage 1 .....	20	15
Stage 2 .....	Angle-tighten a further 70°	
Camshaft bearing cap nuts .....	20	15
Camshaft sprocket bolt .....	45	33
Crankshaft oil seal housing bolts .....	16	12
Crankshaft pulley bolt:		
Stage 1 .....	40	30
Stage 2 .....	Angle-tighten a further 60°	
Cylinder head bolts (Torx type, see text, Section 13):		
Stage 1 .....	20	15
Stage 2 .....	60	44
Stage 3 .....	Angle-tighten a further 180°	
Cylinder head cover bolts .....	20	15
Engine-to-transmission fixing bolts .....	50	37
Engine/transmission left-hand mounting:		
Centre nut .....	65	48
Mounting bracket to body bolts .....	25	18
Mounting rubber nuts/bolts .....	25	18
Mounting stud-to-bracket .....	50	37
Engine/transmission rear mounting:		
Connecting link-to-mounting rubber nut/bolt .....	50	37
Connecting link-to-subframe nut/bolt .....	50	37
Mounting assembly-to-block bolts .....	45	33
Engine/transmission right-hand mounting:		
Engine (tensioner assembly) bracket bolts .....	18	13
Mounting bracket retaining nuts .....	45	33
Rubber mounting to body .....	40	30
Flywheel bolts* .....	50	37
Injection pump sprocket nut .....	50	37
Injection pump sprocket puller retaining screws .....	10	7
Main bearing cap bolts .....	70	52
Oil pump mounting bolts .....	13	10
Sump bolts .....	19	14
Timing belt cover bolts .....	8	6
Timing belt tensioner adjustment bolt .....	18	13
Timing belt tensioner pivot nut .....	18	13

\* New nuts/bolts must be used

**1 General information****How to use this Chapter**

This Part of Chapter 2 describes those repair procedures that can reasonably be carried out on the engine while it remains in the car. If the engine has been removed from the car and is being dismantled, as described in Part E, any preliminary dismantling procedures can be ignored.

Note that, while it may be possible physically to overhaul items such as the piston/connecting rod assemblies while the engine is in the car, such tasks are not normally carried out as separate operations. Usually, several additional procedures (not to

mention the cleaning of components and of oilways) have to be carried out. For this reason, all such tasks are classed as major overhaul procedures, and are described in Part E of this Chapter.

Part E describes the removal of the engine/transmission from the vehicle, and the full overhaul procedures that can then be carried out.

**Engine description**

The XUD engine is a well-proven unit which has appeared in many Peugeot and Citroën vehicles. The engine is of four-cylinder overhead camshaft design, mounted transversely, with the transmission mounted on the left-hand side.

A toothed timing belt drives the camshaft, fuel injection pump and coolant pump. Followers are fitted between the camshaft and valves. Valve clearance adjustment is by

means of shims. The camshaft is supported by three bearings machined directly in the cylinder head.

The crankshaft runs in five main bearings of the usual shell type. Endfloat is controlled by thrustwashers either side of No 2 main bearing.

The pistons are selected to be of matching weight, and incorporate fully-floating gudgeon pins retained by circlips.

The oil pump is chain-driven from the front of the crankshaft. An oil cooler is fitted to all engines.

Throughout the manual, it is often necessary to identify the engines not only by their cubic capacity, but also by their engine code. The engine code, consists of three letters (eg, D9B). The code is stamped on a plate attached to the front of the cylinder block.

## Operations with engine in car

The following work can be carried out with the engine in the car:

- Compression pressure – testing.
- Cylinder head cover – removal and refitting.
- Crankshaft pulley – removal and refitting.
- Timing belt covers – removal and refitting.
- Timing belt – removal, refitting and adjustment.
- Timing belt tensioner and sprockets – removal and refitting.
- Camshaft oil seal – renewal.
- Camshaft and followers – removal, inspection and refitting.
- Valve clearances – checking and adjustment.
- Cylinder head – removal and refitting.
- Cylinder head and pistons – decarbonising.
- Sump – removal and refitting.
- Oil pump – removal and refitting.
- Crankshaft oil seals – renewal.
- Engine/transmission mountings – inspection and renewal.
- Flywheel – removal, inspection and refitting.

## 2 Compression and leakdown tests – description and interpretation

### Compression test

**Note:** A compression tester specifically designed for diesel engines must be used for this test.

1 When engine performance is down, or if misfiring occurs which cannot be attributed to the fuel system, a compression test can provide diagnostic clues as to the engine's condition. If the test is performed regularly, it can give warning of trouble before any other symptoms become apparent.

2 A compression tester specifically intended for diesel engines must be used, because of the higher pressures involved. The tester is connected to an adapter which screws into the glow plug or injector hole. On these models, an adapter suitable for use in the injector holes will be required, due to the limited access to the glow plug holes (see illustration). It is



2.2 Performing a compression test

unlikely to be worthwhile buying such a tester for occasional use, but it may be possible to borrow or hire one – if not, have the test performed by a garage.

3 Unless specific instructions to the contrary are supplied with the tester, observe the following points:

- The battery must be in a good state of charge, the air filter must be clean, and the engine should be at normal operating temperature.
- All the injectors or glow plugs should be removed before starting the test. If removing the injectors, also remove the flame shield washers, otherwise they may be blown out.
- The anti-theft system electronic engine immobiliser unit wiring connector at the rear of the injection pump must be disconnected.

4 There is no need to hold the accelerator pedal down during the test, because the diesel engine air inlet is not throttled.

5 The actual compression pressures measured are not so important as the balance between cylinders. Values are given in the Specifications.

6 The cause of poor compression is less easy to establish on a diesel engine than on a petrol one. The effect of introducing oil into the cylinders ('wet' testing) is not conclusive, because there is a risk that the oil will sit in the swirl chamber or in the recess on the piston crown instead of passing to the rings. However, the following can be used as a rough guide to diagnosis.

7 All cylinders should produce very similar pressures; any difference greater than that specified indicates the existence of a fault. Note that the compression should build-up quickly in a healthy engine; low compression on the first stroke, followed by gradually-increasing pressure on successive strokes, indicates worn piston rings. A low compression reading on the first stroke, which does not build-up during successive strokes, indicates leaking valves or a blown head gasket (a cracked head could also be the cause). Deposits on the undersides of the valve heads can also cause low compression.

8 A low reading from two adjacent cylinders is almost certainly due to the head gasket having blown between them; the presence of coolant in the engine oil will confirm this.

9 If the compression reading is unusually high, the cylinder head surfaces, valves and pistons are probably coated with carbon deposits. If this is the case, the cylinder head should be removed and decarbonised (see Part E).

### Leakdown test

10 A leakdown test measures the rate at which compressed air fed into the cylinder is lost. It is an alternative to a compression test, and in many ways it is better, since the escaping air provides easy identification of where pressure loss is occurring (piston rings, valves or head gasket).

11 The equipment needed for leakdown testing is unlikely to be available to the home mechanic. If poor compression is suspected, have the test performed by a suitably-equipped garage.

## 3 Engine assembly/valve timing holes – general information and usage

**Note:** Do not attempt to rotate the engine whilst the crankshaft/camshaft/injection pump are locked in position. If the engine is to be left in this state for a long period of time, it is a good idea to place suitable warning notices inside the vehicle, and in the engine compartment. This will reduce the possibility of the engine being accidentally cranked on the starter motor, which is likely to cause damage with the locking pins in place.

1 On all engines, timing holes are drilled in the camshaft sprocket, injection pump sprocket and flywheel. The holes are used to align the crankshaft, camshaft and injection pump, and to prevent the possibility of the valves contacting the pistons when refitting the cylinder head, or when refitting the timing belt. When the holes are aligned with their corresponding holes in the cylinder head and cylinder block (as appropriate), suitable diameter bolts/pins can be inserted to lock both the camshaft, injection pump and crankshaft in position, preventing them from rotating unnecessarily. Proceed as follows. **Note:** With the timing holes aligned, No 4 cylinder is at TDC on its compression stroke.

2 Remove the upper timing belt covers as described in Section 6.

3 Firmly apply the handbrake, then jack up the front of the car and support it securely on axle stands (see *Jacking and vehicle support*). Remove the right-hand front roadwheel.

4 The crankshaft must now be turned until the three bolt holes in the camshaft and injection pump sprockets (one hole in the camshaft sprocket, two holes in the injection pump sprocket) are aligned with the corresponding holes in the engine front plate. To gain access to the right-hand end of the engine, the wheel arch plastic liner must be removed. The liner is secured by various screws and clips under the wheel arch. Release all the fasteners, and remove liner from under the front wing. Where necessary, unclip the coolant hoses from under the wing to improve access further. The crankshaft can then be turned using a suitable socket and extension bar fitted to the pulley bolt. Note that the crankshaft must always be turned in a clockwise direction (viewed from the right-hand side of vehicle).

5 Insert an 8 mm diameter rod or drill through the hole in the left-hand flange of the cylinder block by the starter motor; if necessary, carefully turn the crankshaft either way until



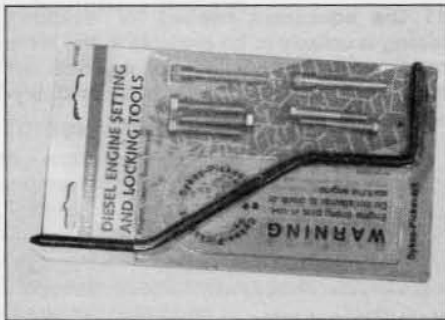

3.5a Suitable tools available for locking the engine in the TDC position

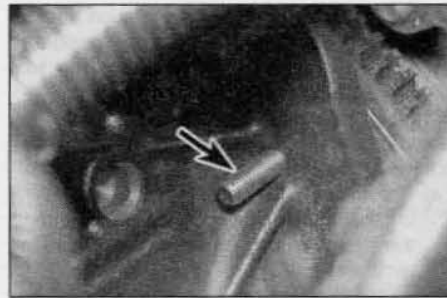

3.5b Rod (arrowed) inserted through cylinder block into timing hole in the flywheel

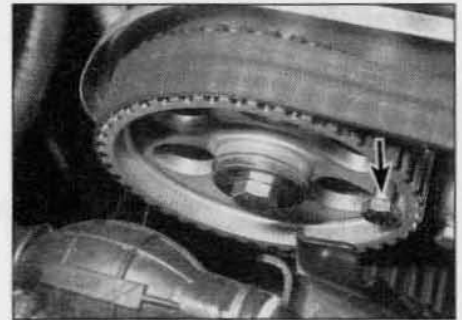

3.6a Bolt (arrowed) inserted through timing hole in the camshaft sprocket

the rod enters the timing hole in the flywheel (see illustrations).

6 Insert three 8 mm bolts through the holes in the camshaft and fuel injection pump sprockets, and screw them into the engine finger-tight (see illustrations).

7 The crankshaft, camshaft and injection pump are now locked in position, preventing unnecessary rotation.

#### 4 Cylinder head cover - removal and refitting

##### Removal

1 On the 1.9 litre (D9B) engine, remove the air distribution housing as described in Chapter 4B.

2 Disconnect the breather hose from the front of the camshaft cover and, where necessary,

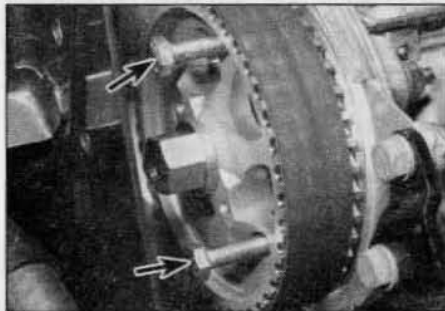

3.6b Bolts (arrowed) inserted through timing holes in the injection pump sprocket

remove the inlet duct from the inlet manifold.

3 Unscrew the securing bolt and remove the fuel hose bracket from the right-hand end of the cylinder head cover (see illustration).

4 Note the locations of any brackets secured by the three cylinder head cover bolts, then unscrew the bolts. Recover the metal and fibre washers under each bolt (see illustration).

5 Carefully move any hoses clear of the cylinder head cover.

6 Lift off the cover, and recover the rubber seal (see illustration). Examine the seal for signs of damage and deterioration, and if necessary, renew it.

##### Refitting

7 Refitting is a reversal of removal, bearing in mind the following points:

- Refit any brackets in their original positions noted before removal.
- Where applicable, refit the air distribution housing, as described in Chapter 4B.

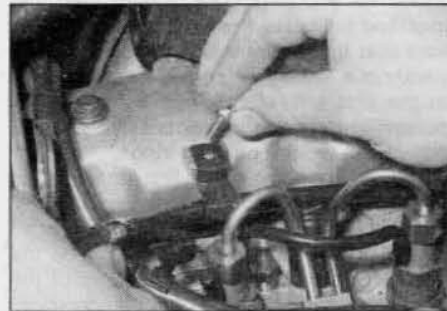

4.3 Removing the fuel hose bracket from the cylinder head cover

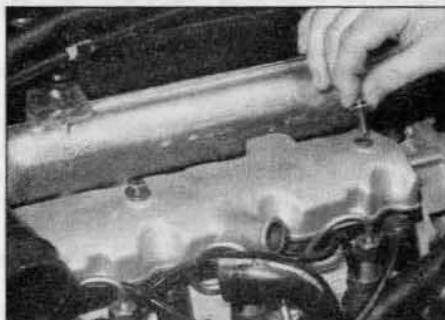

4.4 Remove the retaining bolts and washers ...



4.6 ... and lift off the cylinder head cover

#### 5 Crankshaft pulley - removal and refitting

##### Removal

1 Remove the auxiliary drivebelt as described in Chapter 1B.

2 To prevent crankshaft turning whilst the pulley retaining bolt is being slackened, select top gear and have an assistant apply the brakes firmly. Alternatively, the flywheel ring gear can be locked using a suitable tool made from steel angle (see illustration). Remove the cover plate from the base of the transmission bellhousing and bolt the tool to the bellhousing flange so it engages with the ring gear teeth. Do not attempt to lock the pulley by inserting a bolt/drill through the timing hole. If the timing hole bolt/drill is in position, temporarily remove it prior to slackening the pulley bolt, then refit it once the bolt has been slackened.

3 Unscrew the retaining bolt and washer, then slide the pulley off the end of the crankshaft. If the pulley locating roll pin or Woodruff key (as applicable) is a loose fit, remove it and store it with the pulley for safe-keeping. If the pulley is tight fit, it can be drawn off the crankshaft using a suitable puller.

##### Refitting

4 Ensure that the Woodruff key is correctly located in its crankshaft groove, or that the roll pin is in position (as applicable). Refit the



5.2 Use a fabricated tool similar to this to lock the flywheel ring gear and prevent crankshaft rotation



pulley to the end of the crankshaft, aligning its locating groove or hole with the Woodruff key or pin.

**5** Thoroughly clean the threads of the pulley retaining bolt, then apply a coat of locking compound to the bolt threads. Peugeot/Citroën recommend the use of Loctite (available from your dealer); in the absence of this, any good-quality locking compound may be used.

**6** Refit the crankshaft pulley retaining bolt and washer. Tighten the bolt to the specified torque, then through the specified angle, preventing the crankshaft from turning using the method employed on removal.

**7** Refit and tension the auxiliary drivebelt as described in Chapter 1B.

## 6 Timing belt covers – removal and refitting



### Removal

#### Upper covers

**1** If procedures are to be carried out which involve removal of the timing belt, remove the right-hand engine mounting-to-body bracket as described in Section 9. This will greatly improve access.

**2** Undo the two bolts securing the camshaft sprocket cover and the nut and bolt securing the injection pump sprocket cover.

**3** Release the covers from their locations and lift them off the engine.

#### Lower cover

**4** Remove the crankshaft pulley as described in Section 5.

**5** Remove both upper covers as described previously.

**6** Undo the two remaining securing nuts, and remove the lower cover.

### Refitting

**7** Refitting is a reversal of the relevant removal procedure, ensuring that each cover section is correctly located, and that the cover retaining nuts and/or bolts are tightened securely.

## 7 Timing belt – removal, inspection, refitting and tensioning



### General

**1** The timing belt drives the camshaft, injection pump, and coolant pump from a toothed sprocket on the front of the crankshaft. The belt also drives the brake vacuum pump indirectly via the flywheel end of the camshaft. If the belt breaks or slips in service, the pistons are likely to hit the valve heads, resulting in expensive damage.

**2** The timing belt should be renewed at the

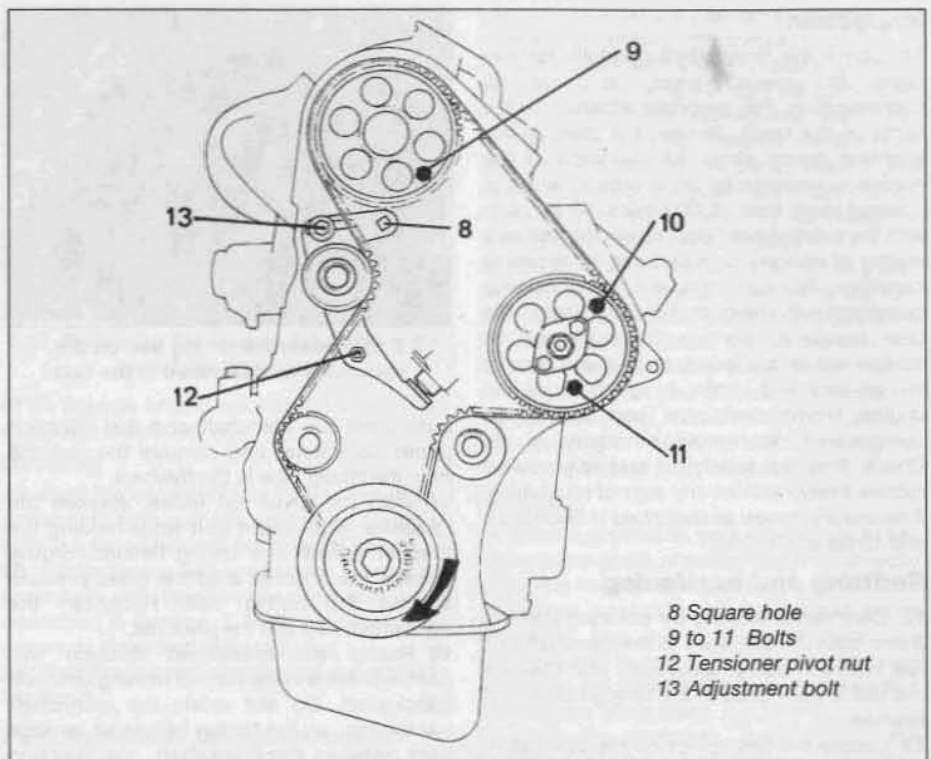

7.9 Removing the timing belt

specified intervals, or earlier if it is contaminated with oil, or at all noisy in operation (a 'scraping' noise due to uneven wear).

**3** If the timing belt is being removed, it is a wise precaution to check the condition of the coolant pump at the same time (check for signs of coolant leakage). This may avoid the need to remove the timing belt again at a later stage, should the coolant pump fail.

### Removal

**4** Disconnect the battery negative terminal (refer to *Disconnecting the battery* in the Reference Chapter).

**5** Remove the crankshaft pulley as described in Section 5.

**6** Remove the timing belt covers as described in Section 6.

**7** Temporarily refit the crankshaft pulley to

enable the engine to be turned, then align the engine assembly/valve timing holes as described in Section 3, and lock the camshaft sprocket, injection pump sprocket and flywheel in position. *Do not* attempt to rotate the engine whilst the pins are in position.

**8** Remove the right-hand engine mounting-to-body bracket as described in Section 9.

**9** Loosen the timing belt tensioner pivot nut and adjustment bolt, then turn the tensioner bracket anti-clockwise to release the tension. Retighten the adjustment bolt to hold the tensioner in the released position. If available, use a 10 mm square drive extension in the hole provided, to turn the tensioner bracket against the spring tension (*see illustration*).

**10** Mark the timing belt with an arrow to indicate its running direction, if it is to be re-used. Remove the belt from the sprockets (*see illustrations*).

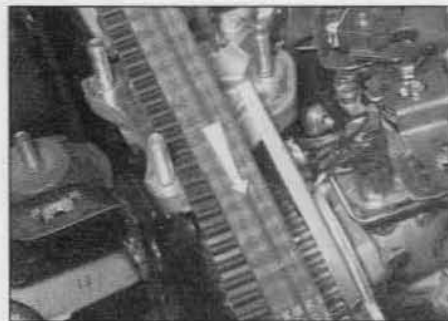

7.10a Mark the timing belt with an arrow to indicate its running direction



7.10b Removing the timing belt

## Inspection

**11** Check the timing belt carefully for any signs of uneven wear, split or oil contamination. Pay particular attention to the roots of the teeth. Renew it if there is the slightest doubt about its condition. If the engine is undergoing an overhaul, and has covered more than 40 000 miles (60 000 km) with the existing belt fitted, renew the belt as a matter of course, regardless of its apparent condition. The cost of a new belt is nothing compared with the cost of repairs, should the belt break in service. If signs of oil contamination are found, trace the source of the oil leak and rectify it. Wash down the engine timing belt area and all related components, to remove all traces of oil. Check that the tensioner and idler pulley rotates freely, without any sign of roughness. If necessary, renew as described in Sections 9 and 10 (as applicable).

## Refitting and tensioning

**12** Commence refitting by ensuring that the 8 mm bolts are still fitted to the camshaft and fuel injection pump sprockets, and that the rod/drill is positioned in the timing hole in the flywheel.

**13** Locate the timing belt on the crankshaft sprocket, making sure that, where applicable, the direction of rotation arrow is facing the correct way.

**14** Engage the timing belt with the crankshaft sprocket, hold it in position, then feed the belt over the remaining sprockets in the following order:

- Idler roller.
- Fuel injection pump.
- Camshaft.
- Tensioner roller.
- Coolant pump.

**15** Be careful not to kink or twist the belt. To ensure correct engagement, locate only a half-width on the injection pump sprocket before feeding the timing belt onto the camshaft sprocket, keeping the belt taut and fully engaged with the crankshaft sprocket. Locate the timing belt fully onto the sprockets (see illustration).

**16** Unscrew and remove the 8 mm locking

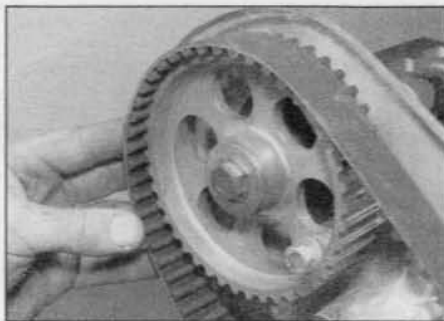

**7.15** Locate the timing belt on the sprockets as described in the text

bolts from the camshaft and fuel injection pump sprockets, and remove the rod/drill from the timing hole in the flywheel.

**17** With the pivot nut loose, slacken the tensioner adjustment bolt while holding the bracket against the spring tension. Slowly release the bracket until the roller presses against the timing belt. Retighten the adjustment bolt and the pivot nut.

**18** Rotate the crankshaft through two complete turns in the normal running direction (clockwise). Do not rotate the crankshaft backwards, as the timing belt must be kept tight between the crankshaft, fuel injection pump and camshaft sprockets.

**19** Loosen the tensioner adjustment bolt and the pivot nut to allow the tensioner spring to push the roller against the timing belt, then tighten both the adjustment bolt and pivot nut to the specified torque.

**20** Check that the timing holes are all correctly positioned by reinserting the sprocket locking bolts and the rod/drill in the flywheel timing hole, as described in Section 3. If the timing holes are not correctly positioned, the timing belt has been incorrectly fitted (possibly one tooth out on one of the sprockets) – in this case, repeat the refitting procedure from the beginning.

**21** Refit the upper timing belt covers as described in Section 6.

**22** Refit the right-hand engine mounting-to-body bracket, with reference to Section 9.

**23** Refit the crankshaft pulley as described in Section 5.

## 8 Timing belt sprockets – removal and refitting



### Camshaft sprocket

#### Removal

**1** Remove the upper timing belt covers as described in Section 6.

**2** The camshaft sprocket bolt must now be loosened. The camshaft must be prevented from turning as the sprocket bolt is unscrewed, and this can be done in one of two ways, as follows (see illustrations). Do not remove the camshaft sprocket bolt at this stage.

a) Make up a tool similar to that shown, and use it to hold the sprocket stationary by means of the holes in the sprocket.

b) Remove the cylinder head cover as described in Section 4. Prevent the camshaft from turning by holding it with a suitable spanner on the lug between Nos 3 and 4 camshaft lobes.

**3** Align the engine assembly/valve timing holes as described in Section 3, and lock the camshaft sprocket, injection pump sprocket and flywheel in position. Do not attempt to rotate the engine whilst the pins are in position.

**4** Loosen the timing belt tensioner pivot nut and adjustment bolt, then turn the tensioner bracket anti-clockwise to release the tension, and retighten the adjustment bolt to hold the tensioner in the released position. If available, use a 10 mm square drive extension in the hole provided, to turn the tensioner bracket against the spring tension. Slip the timing belt off the sprocket.

**5** Remove the previously slackened camshaft sprocket retaining bolt and washer.

**6** Remove the locking bolt securing the camshaft sprocket in the TDC position.

**7** Slide the sprocket off the end of the camshaft (see illustration). If the locating peg is a loose fit in the rear of the sprocket, remove it for safe-keeping. Examine the camshaft oil seal for signs of oil leakage and, if necessary, renew it as described in Section 16.

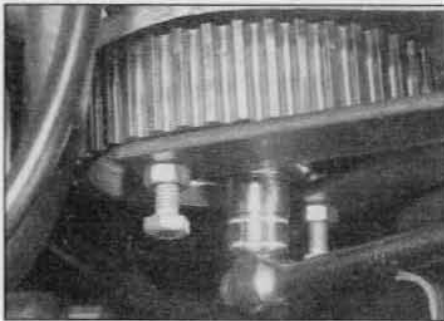

**8.2a** Using a mome-made tool to prevent the camshaft sprocket from turning



**8.2b** Holding the camshaft using a spanner on the lug between Nos 3 and 4 lobes

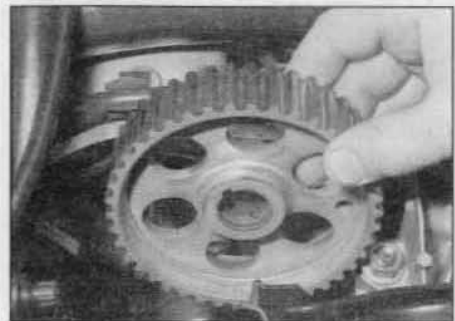

**8.7** Withdrawing the camshaft sprocket



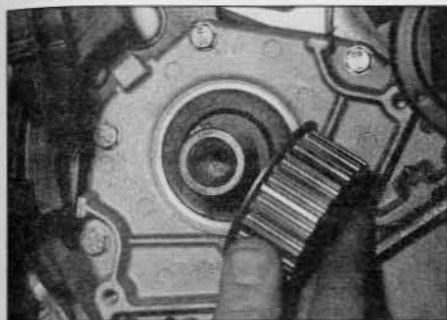

8.16 Withdrawing the crankshaft sprocket

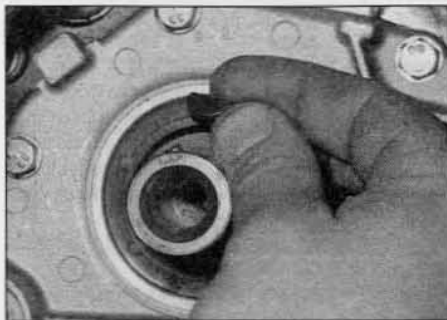

8.17 Removing the Woodruff key from the end of the crankshaft

### Refitting

8 Where applicable, refit the Woodruff key to the end of the camshaft, then refit the camshaft sprocket. Note that the sprocket will only fit one way round (with the protruding centre boss against the camshaft), as the end of the camshaft is tapered.

9 Refit the sprocket retaining bolt and washer. Tighten the bolt to the specified torque, preventing the camshaft from turning as during removal.

10 Where applicable, refit the cylinder head cover as described in Section 4.

11 Align the holes in the camshaft sprocket and the engine front plate, and refit the 8 mm bolt to lock the camshaft in position.

12 Fit the timing belt around the fuel injection pump sprocket (where applicable) and the camshaft sprocket, and tension the timing belt as described in Section 7.

13 Refit the upper timing belt covers as described in Section 6.

### Crankshaft sprocket

#### Removal

14 Remove the crankshaft pulley as described in Section 5.

15 Proceed as described in paragraphs 1, 3 and 4.

16 Disengage the timing belt from the crankshaft sprocket, and slide the sprocket off the end of the crankshaft (see illustration).

17 Remove the Woodruff key from the crankshaft, and store it with the sprocket for safe-keeping (see illustration).

18 Examine the crankshaft oil seal for signs

of oil leakage and, if necessary, renew it as described in Section 16.

### Refitting

19 Refit the Woodruff key to the end of the crankshaft, then refit the crankshaft sprocket (with the flange nearest the cylinder block).

20 Fit the timing belt around the crankshaft sprocket, and tension the timing belt as described in Section 7. Refit the timing belt covers as described in Section 6.

21 Refit the crankshaft pulley as described in Section 5.

### Fuel injection pump sprocket

#### Removal

22 Proceed as described in paragraphs 1, 3 and 4.

23 Make alignment marks on the fuel injection pump sprocket and the timing belt, to ensure that the sprocket and timing belt are correctly aligned on refitting.

24 Remove the 8 mm bolts securing the fuel injection pump sprocket in the TDC position.

25 On certain models, the sprocket may be fitted with a built-in puller, which consists of a plate bolted to the sprocket. The plate contains a captive nut (the sprocket securing nut), which is screwed onto the fuel injection pump shaft. On models not fitted with the built-in puller, a suitable puller can be made up using a short length of bar, and two M7 bolts screwed into the holes provided in the sprocket.

26 The fuel injection pump shaft must be prevented from turning as the sprocket nut is unscrewed, and this can be achieved using a tool similar to that shown (see illustration).

Use the tool to hold the sprocket stationary by means of the holes in the sprocket.

27 On models with a built-in puller, unscrew the sprocket securing nut until the sprocket is freed from the taper on the pump shaft, then withdraw the sprocket. Recover the Woodruff key from the end of the pump shaft if it is loose. If desired, the puller assembly can be removed from the sprocket by removing the two securing screws and washers.

28 On models not fitted with a built-in puller, partially unscrew the sprocket securing nut, then fit the improvised puller, and tighten the two bolts (forcing the bar against the sprocket nut), until the sprocket is freed from the taper on the pump shaft (see illustration). Withdraw the sprocket, and recover the Woodruff key from the end of the pump shaft if it is loose. Remove the puller from the sprocket.

### Refitting

29 Where applicable, refit the Woodruff key to the pump shaft, ensuring that it is correctly located in its groove.

30 Where applicable, if the built-in puller assembly has been removed from the sprocket, refit it, and tighten the two securing screws to the specified torque, ensuring that the washers are in place.

31 Refit the sprocket, then tighten the securing nut to the specified torque, preventing the pump shaft from turning as during removal.

32 Make sure that the 8 mm bolts are fitted to the camshaft and fuel injection pump sprockets, and that the rod/drill is positioned in the flywheel timing hole.

33 Fit the timing belt around the fuel injection pump sprocket, ensuring that the marks made on the belt and sprocket before removal are aligned.

34 Tension the timing belt (see Section 7).

35 Refit the upper timing belt covers as described in Section 6.

### Coolant pump sprocket

36 The coolant pump sprocket is integral with the pump, and cannot be removed.

### 9 Right-hand mounting bracket and timing belt tensioner - removal and refitting



#### General

1 The timing belt tensioner is operated by a spring and plunger housed in the right-hand engine mounting bracket, which is bolted to the end face of the engine. The engine mounting is attached to the mounting on the body via the engine mounting-to-body bracket.

### Right-hand engine mounting-to-body bracket

#### Removal

2 Before removing the bracket, the engine must be supported, preferably using a

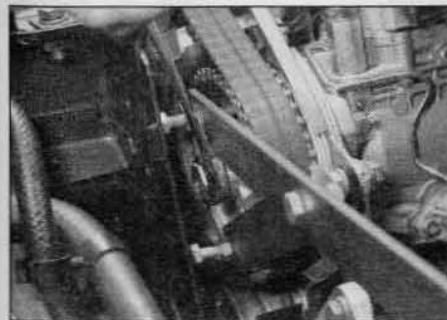

8.26 Using a home-made tool to prevent the injection pump sprocket from turning

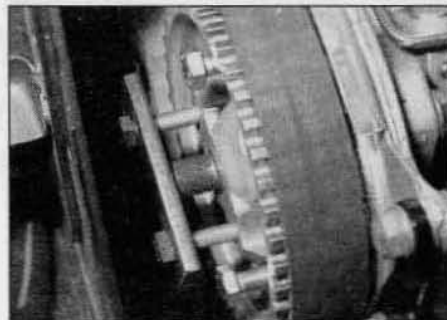

8.28 Home-made puller fitted to the fuel injection pump sprocket



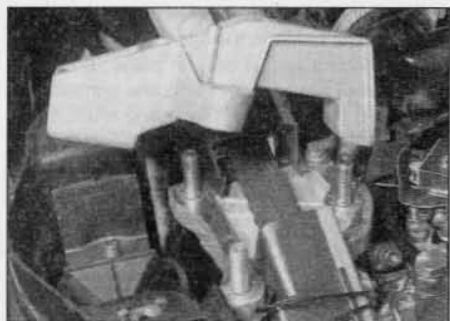

**9.4 Removing the engine mounting-to-body bracket**

suitable hoist and lifting tackle attached to the lifting bracket at the right-hand end of the engine. Alternatively, the engine can be supported using a trolley jack and interposed block of wood beneath the sump, in which case, be prepared for the engine to tilt backwards when the bracket is removed.

3 Release the retaining clips and brackets, and position the diesel priming pump and all the relevant hoses and cables clear of the engine mounting assembly and suspension top mounting.

4 Unscrew the three nuts securing the mounting bracket to the engine bracket, and the single nut securing the bracket to the rubber mounting on the body, then lift off the bracket (see illustration).

#### Refitting

5 Refitting is a reversal of removal. Tighten the nuts and bolts to the specified torque.

#### Timing belt tensioner and right-hand engine mounting bracket

**Note:** A suitable tool will be required to retain the timing belt tensioner plunger during this operation.

#### Removal

6 Remove the engine mounting-to-body bracket as described previously in this Section, and remove the auxiliary drivebelt as described in Chapter 1B.

7 If not already done, support the engine with a trolley jack and interposed block of wood beneath the sump.

8 Where applicable, disconnect the hoist and lifting tackle supporting the engine from the right-hand lifting bracket (this is necessary because the lifting bracket is attached to the engine mounting bracket, and must be removed).

9 Unscrew the two retaining bolts and remove the engine lifting bracket.

10 Align the engine assembly/valve timing holes as described in Section 3, and lock the camshaft sprocket, injection pump sprocket and flywheel in position. *Do not* rotate the engine whilst the pins are in position.

11 Loosen the timing belt tensioner pivot nut and adjustment bolt, then turn the tensioner bracket anti-clockwise until the adjustment bolt is in the middle of the slot, and retighten the adjustment bolt. Use a 10 mm square drive extension in the hole provided, to turn the tensioner bracket against the spring tension.

12 Mark the timing belt with an arrow to indicate its running direction, if it is to be re-used. Remove the belt from the sprockets.

13 A tool must now be obtained in order to hold the tensioner plunger in the engine mounting bracket.

14 The Peugeot/Citroën tool is designed to slide in the two lower bolt holes of the mounting bracket. It should be easy to fabricate a similar tool out of sheet metal, using 10 mm bolts and nuts instead of metal rods (see **Tool Tip**).

15 Unscrew the two lower engine mounting bracket bolts, then fit the special tool (see illustrations). Grease the inner surface of the tool, to prevent any damage to the end of the tensioner plunger. Unscrew the pivot nut and adjustment bolt, and withdraw the tensioner assembly.

16 Remove the two remaining engine mounting bracket bolts, and withdraw the bracket.

17 Compress the tensioner plunger into the

engine mounting bracket, remove the special tool, then withdraw the plunger and spring.

#### Refitting

18 Refitting is a reversal of removal, bearing in mind the following points:

- Tighten all fixings to the specified torque.
- Refit and tension the timing belt as described in Section 7.
- Refit and tighten the auxiliary drivebelt as described in Chapter 1B.

#### 10 Timing belt idler roller – removal and refitting

#### Removal

1 Remove the auxiliary drivebelt as described in Chapter 1B.

2 Align the engine assembly/valve timing holes as described in Section 3, and lock the camshaft sprocket, injection pump sprocket and flywheel in position. *Do not* rotate the engine whilst the pins are in position.

3 Loosen the timing belt tensioner pivot nut and adjustment bolt, then turn the tensioner bracket anti-clockwise to release the tension, and retighten the adjustment bolt to hold the tensioner in the released position. If available, use a 10 mm square drive extension in the hole provided, to turn the tensioner bracket against the spring tension.

4 Unscrew the two bolts and the stud securing the idler roller assembly to the cylinder block, noting that the upper bolt also secures the engine mounting bracket.

5 Slightly loosen the remaining four engine mounting bolts, noting that the uppermost bolt is on the inside face of the engine front plate, and also secures the engine lifting bracket. Slide out the idler roller assembly.

#### Refitting

6 Refitting is a reversal of removal, bearing in mind the following points:

- Tighten all fixings to the specified torque.
- Tension the timing belt as described in Section 7.
- Refit and tension the auxiliary drivebelt as described in Chapter 1B.



**TOOL TIP**  
Fabricated tool for holding tensioner plunger in the engine mounting bracket.

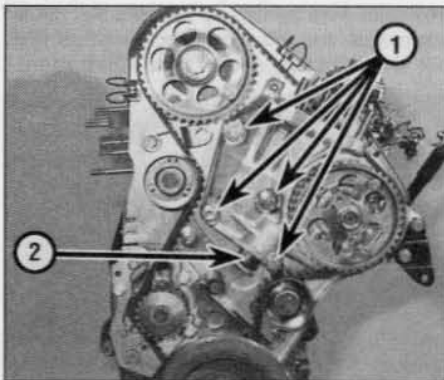

**9.15a View of timing belt end of engine**

- Engine mounting bracket retaining bolts
- Timing belt tensioner plunger



**9.15b Tool in place to hold tensioner plunger in engine mounting bracket – timing belt removed for clarity**

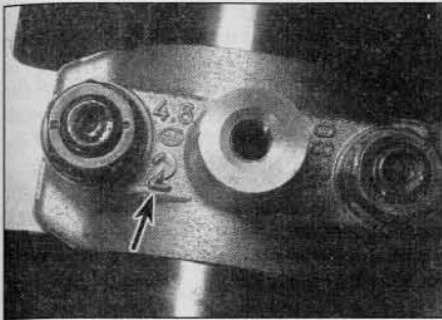

11.4 Camshaft bearing cap identification mark (arrowed)

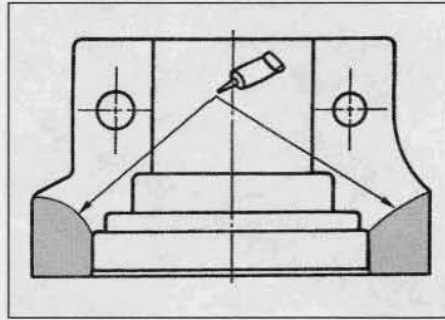

11.17 Apply sealing compound to the end camshaft bearing caps on the areas shown

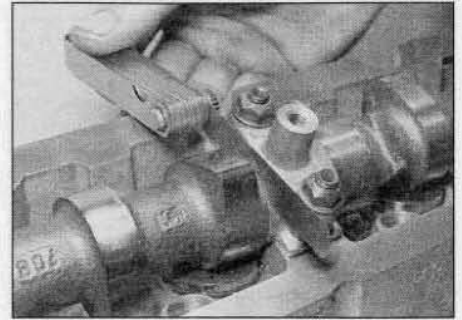

11.19 Checking the camshaft endfloat using a feeler blade

## 11 Camshaft and followers – removal, inspection and refitting



### Removal

- 1 Remove the cylinder head cover as described in Section 4.
- 2 Remove the camshaft sprocket as described in Section 8.
- 3 Remove the braking system vacuum pump as described in Chapter 9.
- 4 The camshaft bearing caps should be numbered from the flywheel end of the engine (see illustration). If the caps are not already numbered, identify them, numbering them from the flywheel end of the engine, and making the marks on the manifold side.
- 5 Progressively unscrew the nuts, then remove the bearing caps.
- 6 Lift the camshaft from the cylinder head. Remove the oil seal from the timing belt end of the camshaft. Discard the seal, a new one should be used on refitting.
- 7 Obtain eight small, clean plastic containers, and number them 1 to 8; alternatively, divide a larger container into eight compartments. Using a rubber sucker, withdraw each follower in turn, and place it in its respective container. Do not interchange the cam followers, or the rate of wear will be much-increased. If necessary, also remove the shim from the top of the valve stem, and store it with its respective follower. Note that the shim may stick to the inside of the follower as it is withdrawn. If this happens, take care not to allow it to drop out as the follower is removed.

### Inspection

- 8 Examine the camshaft bearing surfaces and cam lobes for signs of wear ridges and scoring. Renew the camshaft if any of these conditions are apparent. Examine the condition of the bearing surfaces, both on the camshaft journals and in the cylinder head/bearing caps. If the head bearing surfaces are worn excessively, the cylinder head will need to be renewed.
- 9 Examine the cam follower bearing surfaces which contact the camshaft lobes for wear ridges and scoring. Renew any follower on

which these conditions are apparent. If a follower bearing surface is badly scored, also examine the corresponding lobe on the camshaft for wear, as it is likely that both will be worn. Renew worn components as necessary.

### Refitting

- 10 To prevent any possibility of the valves contacting the pistons as the camshaft is refitted, remove the locking rod/drill from the flywheel and turn the crankshaft a quarter turn in the *opposite* direction to normal rotation, to position all the pistons at mid-stroke. Release the timing belt from the injection pump sprocket while turning the crankshaft.
- 11 Where removed, refit each shim to the top of its original valve stem. *Do not* interchange the shims, as this will upset the valve clearances (see Section 12).
- 12 Liberally oil the cylinder head cam follower bores and the followers. Carefully refit the followers to the cylinder head, ensuring that each follower is refitted to its original bore. Some care will be required to enter the followers squarely into their bores.
- 13 Lubricate the cam lobes and bearing journals with clean engine oil of the specified grade.
- 14 Position the camshaft in the cylinder head, passing it through the engine front plate.
- 15 Temporarily locate the sprocket on the end of the camshaft, and turn the shaft so that the sprocket timing hole is aligned with the corresponding cut-out in the cylinder head. Remove the sprocket.
- 16 Fit the centre bearing cap the correct way round as previously noted, then screw on the nuts and tighten them two or three turns.
- 17 Apply sealing compound to the end bearing caps on the areas shown (see illustration). Fit them in the correct positions, and tighten the nuts two or three turns.
- 18 Tighten all the nuts progressively to the specified torque, making sure that the camshaft remains correctly positioned.
- 19 Check that the camshaft endfloat is as given in the Specifications, using a feeler blade. If not, the camshaft and/or the cylinder head must be renewed. To check the endfloat, push the camshaft fully towards one end of the

cylinder head, and insert a feeler blade between the thrust faces of one of the camshaft lobes and a bearing cap (see illustration).

- 20 If the original camshaft is being refitted, and it is known that the valve clearances are correct, proceed to the next paragraph. Otherwise, check and adjust the valve clearances as described in Section 12.
- 21 Smear the lips of the new oil seal with clean engine oil and fit it onto the camshaft end, making sure its sealing lip is facing inwards. Press the oil seal in until it is flush with the end face of the camshaft bearing cap.
- 22 Refit the braking system vacuum pump as described in Chapter 9.
- 23 Again, temporarily locate the sprocket on the end of the camshaft, and make sure that the sprocket timing hole is aligned with the corresponding cut-out in the cylinder head.
- 24 Turn the crankshaft a quarter turn in the normal direction of rotation so that pistons 1 and 4 are again at TDC.
- 25 Refit the rod/drill to the flywheel timing hole.
- 26 Refit the camshaft sprocket as described in Section 8.
- 27 Refit the cylinder head cover as described in Section 4.

## 12 Valve clearances – checking and adjustment



### Checking

- 1 The importance of having the valve clearances correctly adjusted cannot be overstressed, as they vitally affect the performance of the engine. Checking should not be regarded as a routine operation, however. It should only be necessary when the valve gear has become noisy, after engine overhaul, or when trying to trace the cause of power loss. The clearances are checked as follows. The engine must be cold for the check to be accurate.
- 2 Firmly apply the handbrake, then jack up the front of the car and support it securely on axle stands (see *Jacking and vehicle support*). Remove the right-hand front roadwheel.



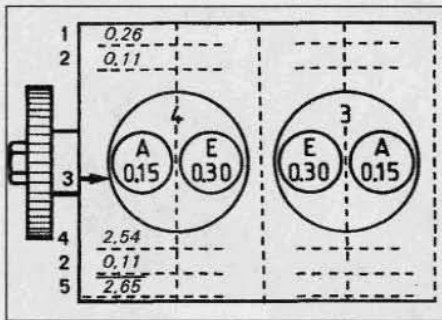

12.6 Example of valve shim thickness calculation

- A Inlet
- E Exhaust
- 1 Measured clearance
- 2 Difference between 1 and 3
- 3 Specified clearance
- 4 Thickness of shim fitted
- 5 Thickness of shim required

3 From underneath the front of the car, remove the wheel arch plastic liner, which is secured by various screws and clips under the wheel arch. Release all the fasteners, and remove liner from under the front wing. Where necessary, unclip the coolant hoses from under the wing to improve access to the crankshaft pulley.

4 The engine can now be turned over using a suitable socket and extension bar fitted to the crankshaft pulley bolt.

**HAYNES**  
**HiNT** The engine will be easier to turn if the fuel injectors or glow plugs are removed.

5 Remove the cylinder head cover as described in Section 4.

6 On a piece of paper, draw the outline of the engine with the cylinders numbered from the flywheel end. Show the position of each valve, together with the specified valve clearance. Above each valve, draw lines for noting (1) the actual clearance and (2) the amount of adjustment required (see illustration).

7 Turn the crankshaft until the inlet valve of

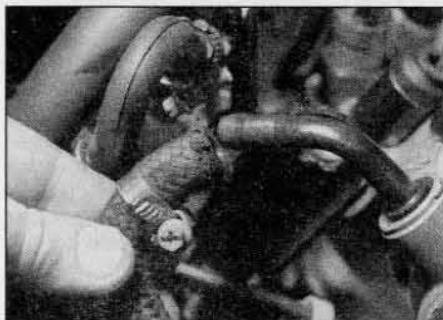

13.4 Disconnecting the vacuum hose from the braking system vacuum pump

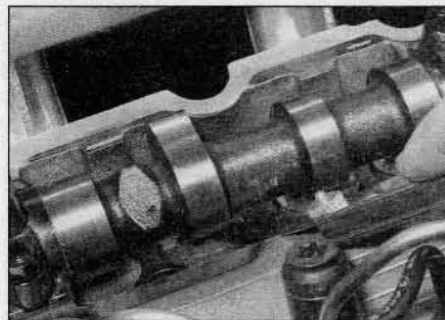

12.8 Measuring a valve clearance using a feeler blade

No 1 cylinder (nearest the transmission) is fully closed, with the tip of the cam facing directly away from the follower.

8 Using feeler blades, measure the clearance between the base of the cam and the follower (see illustration). Record the clearance on line (1).

9 Repeat the measurement for the other seven valves, turning the crankshaft as necessary so that the cam lobe in question is always facing directly away from the relevant follower.

10 Calculate the difference between each measured clearance and the desired value, and record it on line (2). Since the clearance is different for inlet and exhaust valves – make sure that you are aware which valve you are dealing with. The valve sequence from either end of the engine is:

In - Ex - Ex - In - In - Ex - Ex - In

11 If all the clearances are within tolerance, refit the cylinder head cover with reference to Section 4, and where applicable, lower the vehicle to the ground. If any clearance measured is outside the specified tolerance, adjustment must be carried out as described in the following paragraphs.

### Adjustment

12 Remove the camshaft as described in Section 11.

13 Withdraw the first follower and its shim. Clean the shim, and measure its thickness with a micrometer. The shims carry

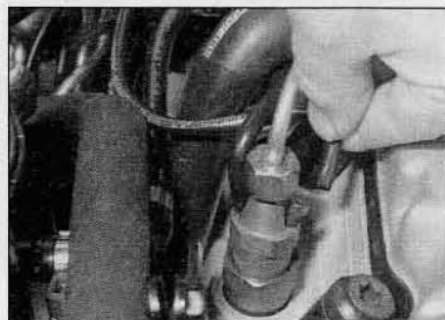

13.5 Disconnecting a fuel injector leak-off hose

thickness markings, but wear may have reduced the original thickness, so be sure to check.

14 Refer to the clearance recorded for the valve concerned. If the clearance was more than that specified, the shim thickness must be increased by the difference recorded (2). If the clearance was less than that specified, the thickness of the shim must be decreased by the difference recorded (2).

15 Draw three more lines beneath each valve on the calculation paper, as shown in illustration 12.6. On line (4) note the measured thickness of the shim, then add or deduct the difference from line (2) to give the final shim thickness required on line (5).

16 Repeat the procedure given in paragraphs 13 to 15 on the remaining valves, keeping each follower identified for position.

17 Obtain the shims required to bring each valve clearance within tolerance. Note that the shims can be swapped around, but not the followers.

18 When reassembling, oil the shim and fit it into the valve retainer, with the size marking face downwards. Oil the follower, and lower it onto the shim. Do not raise the follower after fitting, as the shim may become dislodged.

19 When all the followers are in position, complete with their shims, refit the camshaft as described in Section 11. Recheck the valve clearances before refitting the camshaft cover, to make sure they are correct.

### 13 Cylinder head – removal and refitting

**Note:** This is an involved procedure, and it is suggested that the Section is read thoroughly before starting work. To aid refitting, make notes on the locations of all relevant brackets and the routing of hoses and cables before removal.

#### Removal

1 Disconnect the battery negative terminal (refer to *Disconnecting the battery* in the Reference Chapter).

2 Drain the cooling system as described in Chapter 1B.

3 Remove the inlet and exhaust manifolds as described in Chapter 4B.

4 Slacken the retaining clip and disconnect the vacuum hose from the braking system vacuum pump (see illustration).

5 Disconnect and remove the fuel injector leak-off hoses (see illustration).

6 Disconnect the fuel pipes from the fuel injectors and the fuel injection pump, and remove the pipes as described in Chapter 4B.

7 Unscrew the securing nut and disconnect the feed wire from the relevant glow plug. Recover the washers.

8 Disconnect the coolant hose from the rear,



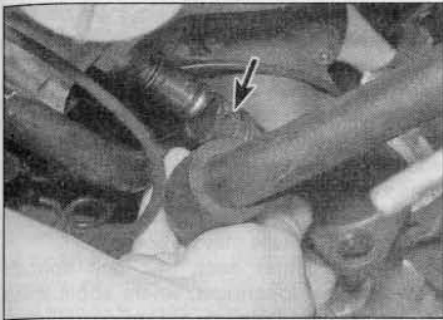

**13.8** Disconnecting the coolant hose (arrowed) from the rear of the cylinder head

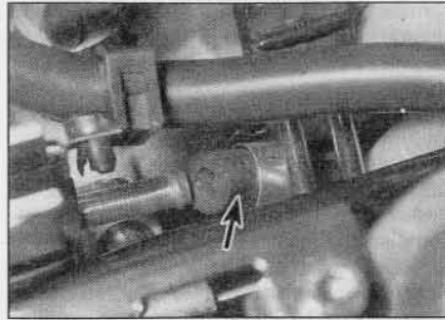

**13.9** Disconnecting the coolant hose (arrowed) from the front of the head

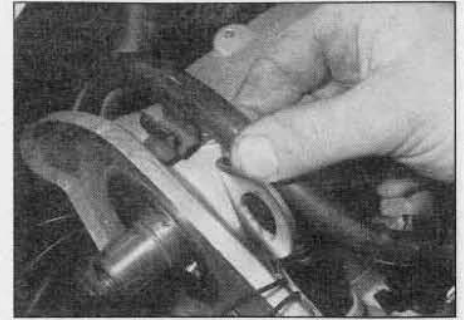

**13.10** Unclip the fuel return hose from its brackets

left-hand end of the cylinder head (see illustration).

**9** Disconnect the small coolant hose from the front timing belt end of the cylinder head (see illustration).

**10** Unclip the fuel return hose from the brackets on the cylinder head, and move it to one side (see illustration).

**11** Disconnect the accelerator cable from the fuel injection pump (refer to Chapter 4B if necessary), and move the cable clear of the cylinder head.

**12** Remove the fuel filter/thermostat housing as described in Chapter 3.

**13** Unscrew the nut or stud securing the coolant hose bracket and the engine lifting bracket to the transmission end of the cylinder head.

**14** Remove the camshaft sprocket as described in Section 8.

**15** Remove the timing belt tensioner and the right-hand engine mounting bracket as described in Section 9.

**16** Remove the timing belt idler roller as described in Section 10.

**17** Remove the bolt securing the engine front plate to the fuel injection pump mounting bracket.

**18** Remove the nut and bolt securing the engine front plate and the alternator mounting bracket to the fuel injection pump mounting bracket, then remove the engine front plate.

**19** Progressively unscrew the cylinder head bolts, in the reverse order to that shown in illustration 13.37.



**13.20** Removing a cylinder head bolt and spacer

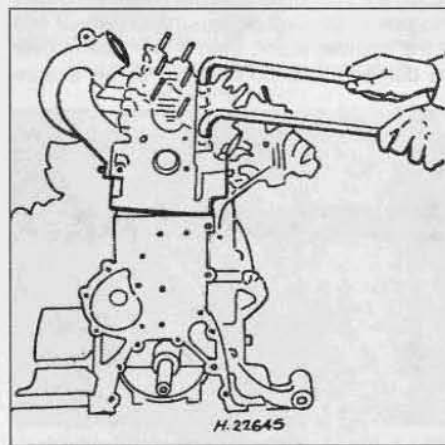

**13.21** Freeing the cylinder head using angled rods



**13.22** Removing the cylinder head

**20** Lift out the bolts and recover the spacers (see illustration).

**21** Release the cylinder head from the cylinder block and location dowel by rocking it. The Peugeot/Citroën tool for doing this consists simply of two metal rods with 90-degree angled ends (see illustration). Do not prise between the mating faces of the cylinder head and block, as this may damage the gasket faces.

**22** Lift the cylinder head from the block, and recover the gasket (see illustration).

#### Preparation for refitting

**23** The mating faces of the cylinder head and cylinder block/crankcase must be perfectly clean before refitting the head. The manufacturer's recommend the use of a scouring agent for this purpose, but acceptable results can be achieved by using a hard plastic or wood scraper to remove all traces of gasket and carbon. The same method can be used to clean the piston crowns. Take particular care to avoid scoring or gouging the cylinder head/cylinder block mating surfaces during the cleaning operations, as aluminium alloy is easily damaged. Make sure that the carbon is not allowed to enter the oil and water passages – this is particularly important for the lubrication system, as carbon could block the oil supply

to the engine's components. Using adhesive tape and paper, seal the water, oil and bolt holes in the cylinder block/crankcase. To prevent carbon entering the gap between the pistons and bores, smear a little grease in the gap. After cleaning each piston, use a small brush to remove all traces of grease and carbon from the gap, then wipe away the remainder with a clean rag.

**24** Check the mating surfaces of the cylinder block/crankcase and the cylinder head for nicks, deep scratches and other damage. If slight, they may be removed carefully with a file, but if excessive, machining may be the only alternative to renewal. If warpage of the cylinder head gasket surface is suspected, use a straight-edge to check it for distortion. Refer to Part E of this Chapter if necessary.

**25** Thoroughly clean the threads of the cylinder head bolt holes in the cylinder block. Ensure that the bolts run freely in their threads, and that all traces of oil and water are removed from each bolt hole.

#### Gasket selection

**26** Check that the timing belt is clear of the fuel injection pump sprocket, then turn the crankshaft until pistons 1 and 4 are at TDC. Position a dial test indicator (dial gauge) on the cylinder block, and zero it on the block face. Transfer the probe to the centre of No 1 piston, then slowly turn the crankshaft back and forth past TDC, noting the highest reading on the indicator. Record this reading.

**27** Repeat this measurement procedure on No 4 piston, then turn the crankshaft half a

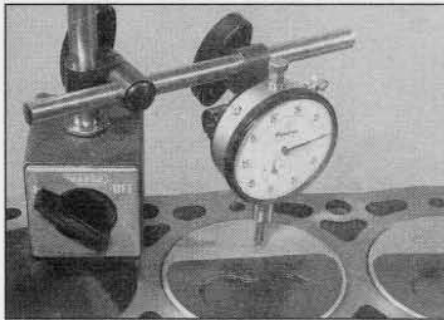

13.27 Measuring piston protrusion

turn (180°) and repeat the procedure on Nos 2 and 3 pistons (see illustration).

28 If a dial test indicator is not available, piston protrusion may be measured using a straight-edge and feeler blades or vernier calipers. However, this is much less accurate, and cannot therefore be recommended.

29 Note down the greatest piston protrusion measurement, and use this to determine the correct cylinder head gasket from the following table. The notches or holes at the corner of the gasket are used for thickness identification. The notches or holes near the centre-line of the gasket identify the engine capacity and type, and have no significance for the gasket thickness (see illustration).

Piston protrusion	Gasket identification
0.56 to 0.67 mm	1 notch
0.68 to 0.71 mm	2 notches
0.72 to 0.75 mm	3 notches
0.76 to 0.79 mm	4 notches
0.80 to 0.83 mm	5 notches

**Cylinder head bolt examination**

30 A number of different cylinder head bolt types have been used on the XUD engines during the course of production, of both hexagon head and Torx head arrangement. If working on an engine fitted with the earlier hexagon head type bolts, these **must** be renewed once disturbed, and the latest Torx head type used. The Torx head type bolts are supplied in two versions, one version with a guiding end-piece at the base of the thread, and one version without an end-piece. It is

permissible to re-use the Torx type bolts providing that their length does not exceed the figures shown below. Note that, if a bolt is modified to locate the gasket (see paragraph 33), a new bolt will be required when finally refitting the cylinder head.

31 Measure the length of each bolt from the base of the head to the end of the shank (or guiding end-piece) (see illustration). Compare the results with the values given in the following table, to determine whether the bolts and spacers should be renewed. **Note:** Considering the stress which the cylinder head bolts are under, it is highly recommended that they are renewed, regardless of their apparent condition.

Bolt length	Action required
<i>Bolts without guiding end-piece:</i>	
Below 121.5 mm	Re-use bolts/spacers
Above 121.5 mm	Renew bolts/spacers
<i>Bolts with guiding end-piece:</i>	
Below 125.5 mm	Re-use bolts/spacers
Above 125.5 mm	Renew bolts/spacers

**Refitting**

32 Turn the crankshaft clockwise (viewed from the timing belt end) until Nos 1 and 4 pistons pass bottom dead centre (BDC) and begin to rise, then position them halfway up their bores. Nos 2 and 3 pistons will also be at their mid-way positions, but descending their bores.

33 Fit the correct gasket the right way round on the cylinder block, with the identification notches or holes at the flywheel/driveplate end of the engine. Make sure that the locating dowel is in place at the timing belt end of the block. Note that, as there is only one locating dowel, it is possible for the gasket to move as the cylinder head is fitted, particularly when the cylinder head is fitted with the engine in the car (due to the inclination of the engine). In the worst instance, this can allow the pistons and/or the valves to hit the gasket, causing engine damage. To avoid this problem, saw the head off a cylinder head bolt, and file (or cut) a slot in the end of the bolt, to enable it to be turned with a screwdriver. Screw the bolt into one of the bolt holes at the flywheel end of the cylinder block, then fit the gasket over the bolt and location dowel. This will ensure

that the gasket is held in position as the cylinder head is fitted.

34 Lower the cylinder head onto the block.

35 Apply a smear of grease to the threads, and to the underside of the heads, of the cylinder head bolts. Peugeot/Citroën recommend the use of Molykote G Rapid Plus (available from your dealer); in the absence of the specified grease, any good-quality high-melting-point grease may be used.

36 Carefully enter each bolt and spacer (convex sides uppermost, where applicable) into its relevant hole (do not drop it in) and screw it in finger-tight. Where applicable, after fitting three or four bolts to locate the cylinder head, unscrew the modified bolt fitted in paragraph 33, and fit a new bolt in its place.

37 Working progressively and in sequence, tighten the cylinder head bolts to their Stage 1 torque setting, using a torque wrench and suitable socket (see illustration).

38 Once all the bolts have been tightened to their Stage 1 torque setting, working again in the specified sequence, tighten each bolt to the specified Stage 2 setting. Finally, angle-tighten the bolts through the specified Stage 3 angle. It is recommended that an angle-measuring gauge is used during this stage of tightening, to ensure accuracy.

39 The remainder of the refitting procedure is a reversal of removal, noting the following points:

- a) Ensure that all wiring is correctly routed, and that all connectors are securely reconnected to the correct components.
- b) Ensure that the coolant hoses are correctly reconnected, and that their retaining clips are securely tightened.
- c) Ensure that all vacuum/breather hoses are correctly reconnected.
- d) Refit the cylinder head cover as described in Section 4.
- e) Reconnect the exhaust system to the manifold, refit the air cleaner housing and ducts, and adjust the accelerator cable, as described in Chapter 4B. If the manifolds were removed, refit these as described in Chapter 4B.
- f) Refill the cooling system as described in Chapter 1B.
- g) Reconnect the battery and bleed the fuel system as described in Chapter 4B.

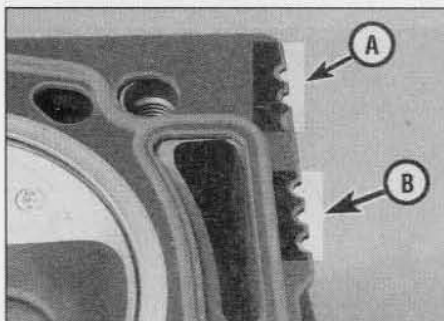

13.29 Cylinder head gasket thickness identification notches (A). Also note engine capacity and type identification notches (B)

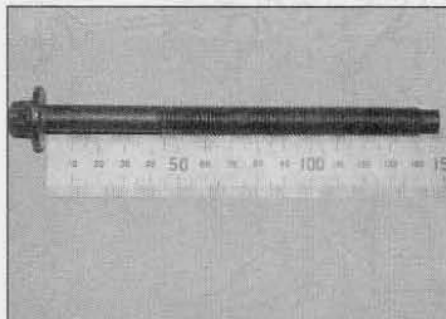

13.31 Measure the length of the cylinder head bolts, to determine whether renewal is required

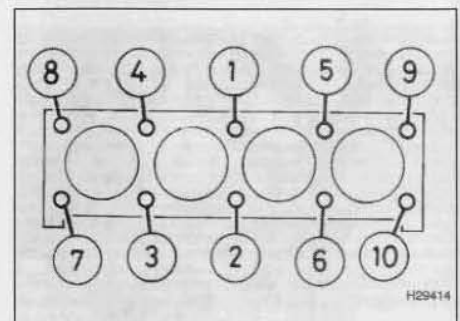

13.37 Cylinder head bolt tightening sequence



## 14 Sump – removal and refitting



### Removal

1 Disconnect the battery negative terminal (refer to *Disconnecting the battery* in the Reference Chapter).

2 Drain the engine oil, then clean and refit the engine oil drain plug, tightening it securely. If the engine is nearing its service interval when the oil and filter are due for renewal, it is recommended that the filter is also removed, and a new one fitted. After reassembly, the engine can then be refilled with fresh oil. Refer to Chapter 1B for further information.

3 Firmly apply the handbrake, then jack up the front of the car and support it securely on axle stands (see *Jacking and vehicle support*).

4 On models with air conditioning, where the compressor is mounted onto the side of the sump, remove the drivebelt as described in Chapter 1B. Unbolt the compressor, and position it clear of the sump. Support the weight of the compressor by tying it to the vehicle, to prevent any excess strain being placed on the compressor lines. Do not disconnect the refrigerant lines from the compressor (refer to the warnings given in Chapter 3).

5 Where necessary, disconnect the wiring connector from the oil level sender unit, which is screwed into the sump.

6 Progressively slacken and remove all the sump retaining bolts. Since the sump bolts vary in length, remove each bolt in turn, and

store it in its correct fitted order by pushing it through a clearly-marked cardboard template. This will avoid the possibility of installing the bolts in the wrong locations on refitting.

7 Try to break the joint by striking the sump with the palm of your hand, then lower and withdraw the sump from under the car. If the sump is stuck (which is quite likely) use a putty knife or similar, carefully inserted between the sump and block. Ease the knife along the joint until the sump is released. Remove the gasket (where fitted), and discard it; a new one must be used on refitting. While the sump is removed, take the opportunity to check the oil pump pick-up/strainer for signs of clogging or splitting. If necessary, remove the pump as described in Section 15, and clean or renew the strainer.

8 On some engines, a large spacer plate is fitted between the sump and the base of the cylinder block/crankcase. If this plate is fitted, undo the two retaining screws from diagonally-opposite corners of the plate. Remove the plate from the base of the engine, noting which way round it is fitted.

### Refitting

9 Clean all traces of sealant/gasket from the mating surfaces of the cylinder block/crankcase and sump, then use a clean rag to wipe out the sump and the engine's interior.

10 Where a spacer plate is fitted, remove all traces of sealant/gasket from the spacer plate, then apply a thin coating of suitable sealant to the plate upper mating surface. Offer up the plate to the base of the cylinder block/crankcase, and securely tighten its retaining screws.

11 On engines where the sump was fitted without a gasket, ensure that the sump mating surfaces are clean and dry, then apply a thin coating of suitable sealant to the sump mating surface.

12 On engines where the sump was fitted with a gasket, ensure that all traces of the old gasket have been removed, and that the sump mating surfaces are clean and dry. Position the new gasket on the top of the sump, using a dab of grease to hold it in position.

13 Offer up the sump to the cylinder block/crankcase. Refit its retaining bolts, ensuring that each is screwed into its original location. Tighten the bolts evenly and progressively to the specified torque setting.

14 Where necessary, align the air conditioning compressor with its mountings on the sump, and insert the retaining bolts. Securely tighten the compressor retaining bolts, then refit the drivebelt as described in Chapter 1B.

15 Reconnect the wiring connector to the oil level sensor (where fitted).

16 Lower the vehicle to the ground, then refill the engine with oil as described in Chapter 1B.

## 15 Oil pump and drive chain – removal, inspection and refitting



### Removal

1 Remove the sump as described in Section 14.

2 Where necessary, undo the two retaining screws, and slide the sprocket cover off the front of the oil pump.

3 Slacken and remove the three bolts securing the oil pump to the base of the cylinder block/crankcase. Disengage the pump sprocket from the chain, and remove the oil pump (see illustration). Where necessary, also remove the spacer plate which is fitted behind the oil pump.

### Inspection

4 Examine the oil pump sprocket for signs of damage and wear, such as chipped or missing teeth. If the sprocket is worn, the pump assembly must be renewed, since the sprocket is not available separately. It is also recommended that the chain and drive sprocket, fitted to the crankshaft, be renewed at the same time. To renew the chain and drive sprocket, first remove the crankshaft timing belt sprocket as described in Section 9. Unbolt the oil seal carrier from the cylinder block. The sprocket, spacer (where fitted) and chain can then be slid off the end of the crankshaft. See Part E of this Chapter for further information.

5 Slacken and remove the bolts (along with the baffle plate, where fitted) securing the strainer cover to the pump body. Lift off the strainer cover, and take off the relief valve piston and spring, noting which way round they are fitted (see illustrations).

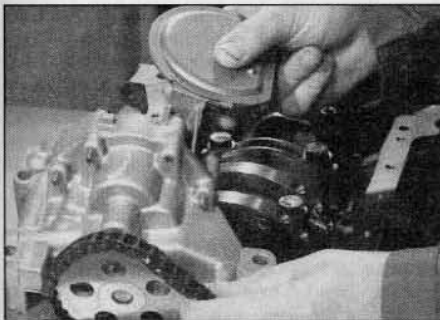

15.3 Removing the oil pump



15.5a Remove the oil pump cover retaining bolts ...

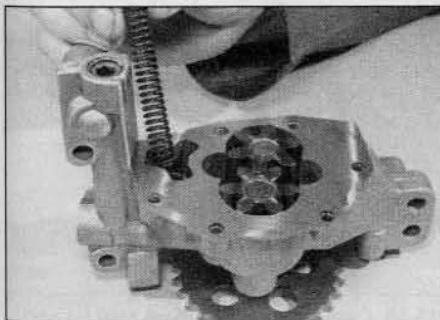

15.5b ... then lift off the cover and remove the spring ...

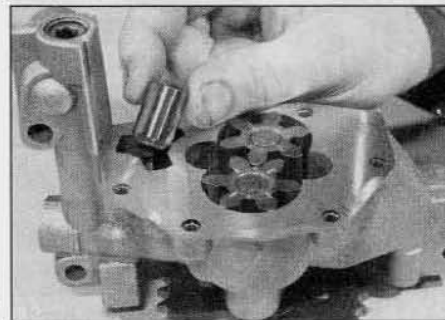

15.5c ... and relief valve piston, noting which way round it is fitted



6 Examine the pump rotors and body for signs of wear ridges or scoring. If worn, the complete pump assembly must be renewed.

7 Examine the relief valve piston for signs of wear or damage, and renew if necessary. The condition of the relief valve spring can only be measured by comparing it with a new one; if there is any doubt about its condition, it should also be renewed. Both the piston and spring are available individually.

8 Thoroughly clean the oil pump strainer with a suitable solvent, and check it for signs of clogging or splitting. If the strainer is damaged, the strainer and cover assembly must be renewed.

9 Locate the relief valve spring and piston in the strainer cover. Refit the cover to the pump body, aligning the relief valve piston with its bore in the pump. Refit the baffle plate (where fitted) and the cover retaining bolts, and tighten them securely.

10 Prime the pump by filling it with clean engine oil before refitting.

### Refitting

11 Offer up the spacer plate (where fitted), then locate the pump sprocket with its drive chain. Seat the pump on the base of the cylinder block/crankcase. Refit the pump retaining bolts, and tighten them to the specified torque setting.

12 Where necessary, slide the sprocket cover into position on the pump. Refit its retaining bolts, tightening them securely.

13 Refit the sump as described in Section 14.

### 16 Oil seals – renewal



### Crankshaft

#### Right-hand oil seal

1 Remove the timing belt crankshaft sprocket as described in Section 8.

2 Note the fitted depth of the oil seal.

3 Pull the oil seal from the housing using a hooked instrument. Alternatively, drill a small hole in the oil seal, and use a self-tapping

screw and a pair of pliers to remove it (see illustration).

4 Clean the oil seal housing and the crankshaft sealing surface.

5 Dip the new oil seal in clean engine oil, and press it into the housing (open end first) to the previously-noted depth, using a suitable tube or socket. A piece of thin plastic or tape wound around the front of the crankshaft is useful to prevent damage to the oil seal as it is fitted.

6 Where applicable, remove the plastic or tape from the end of the crankshaft.

7 Refit the timing belt crankshaft sprocket as described in Section 8.

#### Left-hand oil seal

8 Remove the flywheel as described in Section 18.

9 Proceed as described in paragraphs 2 to 6, noting that when fitted, the outer lip of the oil seal must point outwards; if it is pointing inwards, use a piece of bent wire to pull it out. Take care not to damage the oil seal.

10 Refit the flywheel as described in Section 18.

### Camshaft

#### Right-hand oil seal

11 Remove the camshaft sprocket as described in Section 8. In principle there is no need to remove the timing belt completely, but remember that if the belt has been contaminated with oil, it must be renewed.

12 Pull the oil seal from the housing using a hooked instrument (see illustration). Alternatively, drill a small hole in the oil seal and use a self-tapping screw and a pair of pliers to remove it.

13 Clean the oil seal housing and the camshaft sealing surface.

14 Smear the new oil seal with clean engine oil, then fit it over the end of the camshaft, open end first. A piece of thin plastic or tape wound round the front of the camshaft should prevent damage to the oil seal as it is fitted.

15 Press the seal into the housing until it is flush with the end face of the cylinder head. Use an M10 bolt (screwed into the end of the camshaft), washers and a suitable tube or socket to press the seal into position.

16 Refit the camshaft sprocket as described in Section 8.

17 Where applicable, fit a new timing belt as described in Section 7.

#### Left-hand oil seal

18 No oil seal is fitted to the left-hand end of the camshaft. The sealing is provided by an O-ring fitted to the vacuum pump flange. The O-ring can be renewed after unbolting the pump from the cylinder head (see Chapter 9). Note the smaller O-ring which seals the oil feed gallery to the pump – this may also cause leakage from the pump/cylinder head mating faces if it deteriorates or fails (see illustration).

### 17 Oil level and pressure sensors – general

Refer to Chapter 5A for details.

### 18 Flywheel – removal, inspection and refitting



### Removal

1 Remove the transmission as described in Chapter 7, then remove the clutch assembly as described in Chapter 8.

2 Prevent the flywheel from turning by locking the ring gear teeth (see illustration 5.2). Alternatively, bolt a strap between the flywheel and the cylinder block/crankcase. Do not attempt to lock the flywheel in position using the crankshaft pulley locking tool described in Section 3.

3 Slacken and remove the flywheel retaining bolts, and remove the flywheel from the end of the crankshaft. Be careful not to drop it; it is heavy. If the flywheel locating dowel is a loose fit in the crankshaft end, remove it and store it with the flywheel for safe-keeping. Discard the flywheel bolts; new ones must be used on refitting.

### Inspection

4 Examine the flywheel for scoring of the

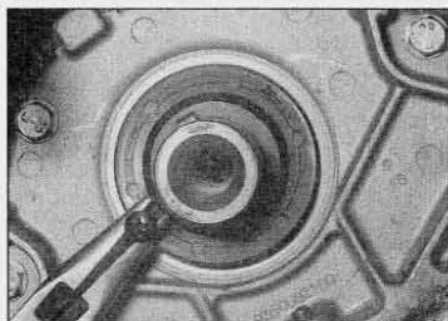

16.3 Self-tapping screw and pliers used to remove the crankshaft right-hand oil seal

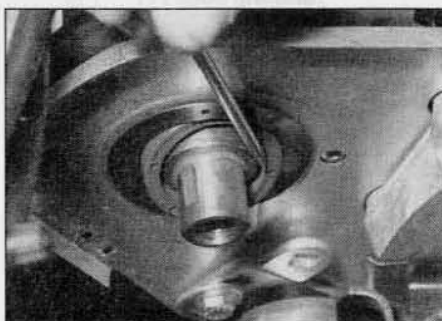

16.12 Removing the camshaft right-hand oil seal

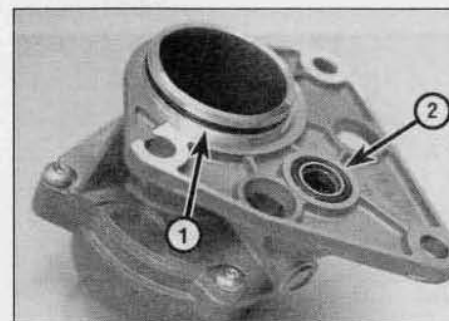

16.18 Camshaft left-hand oil seal (1) and oil feed gallery O-ring (2) on rear of the brake vacuum pump

clutch face, and for wear or chipping of the ring gear teeth. If the clutch face is scored, the flywheel may be surface-ground, but renewal is preferable. Seek the advice of a Peugeot/Citroën dealer or engine reconditioning specialist to see if machining is possible. If the ring gear is worn or damaged, the flywheel must be renewed, as it is not possible to renew the ring gear separately.

### Refitting

5 Clean the mating surfaces of the flywheel and crankshaft. Remove any remaining locking compound from the threads of the crankshaft holes, using the correct size of tap, if available.

#### HAYNES HINT

*If a suitable tap is not available, cut two slots along the threads of one of the old flywheel bolts, and use the bolt to remove the locking compound from the threads.*

6 If the new flywheel retaining bolts are not supplied with their threads already pre-coated, apply a suitable thread-locking compound to the threads of each bolt.

7 Ensure that the locating dowel is in position. Offer up the flywheel, locating it on the dowel, and fit the new retaining bolts.

8 Lock the flywheel using the method employed on dismantling, and tighten the retaining bolts to the specified torque.

9 Refit the clutch as described in Chapter 6. Remove the flywheel locking tool, and refit the transmission as described in Chapter 7.

### 19 Engine oil cooler – removal and refitting



### Removal

1 Firmly apply the handbrake, then jack up the front of the car and support it securely on axle stands (see *Jacking and vehicle support*).

2 Drain the cooling system as described in Chapter 1B. Alternatively, clamp the oil cooler coolant hoses directly above the cooler, and be prepared for some coolant loss as the hoses are disconnected.

3 Position a suitable container beneath the oil filter. Unscrew the filter using an oil filter removal tool if necessary, and drain the oil into the container. If the oil filter is damaged or distorted during removal, it must be renewed. Given the low cost of a new oil filter relative to the cost of repairing the damage which could result if a re-used filter springs a leak, it is probably a good idea to renew the filter in any case.

4 Release the hose clips, and disconnect the coolant hoses from the oil cooler.

5 Unscrew the oil cooler/oil filter mounting bolt from the cylinder block, and withdraw the

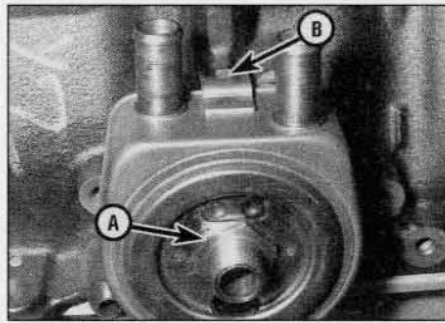

19.5 Oil cooler/oil filter mounting bolt (A) and locating notch (B)

cooler. Note the locating notch in the cooler flange, which fits over the lug on the cylinder block (see illustration). Discard the oil cooler sealing ring; a new one must be used on refitting.

### Refitting

6 Fit a new sealing ring to the recess in the rear of the cooler, then offer the cooler to the cylinder block.

7 Ensure that the locating notch in the cooler flange is correctly engaged with the lug on the cylinder block, then refit the mounting bolt and tighten it securely.

8 Fit the oil filter, then lower the vehicle to the ground. Top-up the engine oil level as described in *Weekly checks*.

9 Refill or top-up the cooling system as described in Chapter 1B or *Weekly checks*. Start the engine, and check the oil cooler for signs of leakage.

### 20 Engine/transmission mountings – inspection and renewal



### Inspection

1 If improved access is required, firmly apply the handbrake, then jack up the front of the car and support it securely on axle stands (see *Jacking and vehicle support*).

2 Check the mounting rubbers to see if they are cracked, hardened or separated from the metal at any point; renew the mounting if any such damage or deterioration is evident.

3 Check that all the mountings' fasteners are securely tightened; use a torque wrench to check if possible.

4 Using a large screwdriver or a crowbar, check for wear in each mounting by carefully levering against it to check for free play. Where this is not possible, enlist the aid of an assistant to move the engine/transmission back-and-forth, or from side-to-side, while you watch the mounting. While some free play is to be expected even from new components, excessive wear should be obvious. If excessive free play is found, check first that the fasteners are correctly secured, then renew any worn components as described below.

### Renewal

#### Right-hand mounting

5 Place a jack beneath the engine, with a block of wood on the jack head. Raise the jack until it is supporting the weight of the engine.

6 Release the retaining clips and brackets, and position the diesel priming pump and all the relevant hoses and cables clear of the engine mounting assembly and suspension top mounting.

7 Slacken and remove the three nuts securing the mounting bracket to the engine bracket.

8 Unscrew the single nut securing the mounting bracket to the rubber mounting, and lift off the bracket.

9 Using a strap wrench or similar tool, unscrew the rubber mounting from the body. Alternatively, fabricate a tool from suitable metal tube with projections to engage in the cut-outs in the mounting.

10 Check for signs of wear or damage on all components, and renew as necessary.

11 On reassembly, securely tighten the rubber mounting in the body.

12 Refit the mounting bracket to the rubber mounting and engine bracket and tighten the retaining nuts to the specified torque.

13 Reposition the diesel priming pump and the hoses and cables move clear for access.

14 Remove the jack from under the engine.

#### Left-hand mounting

15 Remove the battery, battery tray, and mounting plate as described in Chapter 5A.

16 Place a jack beneath the transmission, with a block of wood on the jack head. Raise the jack until it is supporting the weight of the transmission.

17 Slacken and remove the centre nut and washer from the left-hand mounting, then undo the nuts securing the mounting in position and remove it from the engine compartment.

18 If necessary, slide the spacer (where fitted) off the mounting stud, then unscrew the stud from the top of the transmission housing, and remove it along with its washer. If the mounting stud is tight, a universal stud extractor can be used to unscrew it.

19 Check all components carefully for signs of wear or damage, and renew as necessary.

20 Clean the threads of the mounting stud, and apply a coat of thread-locking compound to its threads. Refit the stud and washer to the top of the transmission, and tighten it securely.

21 Slide the spacer (where fitted) onto the mounting stud, then refit the rubber mounting. Tighten both the mounting-to-body bolts and the mounting centre nut to their specified torque settings, and remove the jack from underneath the transmission.

22 Refit the battery mounting plate, battery tray and battery as described in Chapter 5A.

#### Rear mounting

23 Refer to Chapter 2A, Section 16.

The first part of the paper discusses the importance of the study and the objectives of the research. It highlights the need for a comprehensive understanding of the subject matter and the role of the researcher in this process.

The second part of the paper focuses on the methodology used in the study. It details the research design, data collection methods, and the analytical techniques employed to interpret the findings.

The third part of the paper presents the results of the study. It provides a detailed analysis of the data collected and discusses the implications of the findings for the field of study.

The fourth part of the paper discusses the conclusions drawn from the study. It summarizes the key findings and offers suggestions for future research in this area.

The fifth part of the paper provides a final summary of the study. It reiterates the main points and emphasizes the significance of the research for the broader academic community.

The sixth part of the paper includes a list of references. It cites the works of other researchers in the field, providing a foundation for the current study and allowing for further exploration of the topic.

The seventh part of the paper contains a list of appendices. These additional materials provide further detail and support for the main text, including raw data, supplementary analyses, and other relevant information.

The eighth part of the paper includes a list of figures and tables. These visual aids help to present complex data in a clear and concise manner, making it easier for the reader to understand the results of the study.

The ninth part of the paper contains a list of footnotes. These provide additional information and clarification on specific points mentioned in the main text, ensuring that the reader has a complete understanding of the study.

The tenth part of the paper includes a list of acknowledgments. This section expresses gratitude to the individuals and organizations that provided support and assistance throughout the research process.



The first part of the paper discusses the importance of the study and the objectives of the research. It highlights the need for a comprehensive understanding of the subject matter and the role of the researcher in this process.

The second part of the paper focuses on the methodology used in the study. It details the research design, data collection methods, and the analytical techniques employed to interpret the findings.

The third part of the paper presents the results of the study. It provides a detailed analysis of the data collected and discusses the implications of the findings for the field of study.

The fourth part of the paper discusses the conclusions drawn from the study. It summarizes the key findings and offers suggestions for future research in this area.

The fifth part of the paper provides a final summary of the study. It reiterates the main points and emphasizes the significance of the research for the broader academic community.

The sixth part of the paper includes a list of references. It cites the works of other researchers in the field, providing a foundation for the current study and allowing for further exploration of the topic.

The seventh part of the paper contains a list of appendices. These additional materials provide further detail and support for the main text, including raw data, supplementary analyses, and other relevant information.

The eighth part of the paper includes a list of figures and tables. These visual aids help to present complex data in a clear and concise manner, making it easier for the reader to understand the results of the study.

The first part of the paper discusses the importance of the study and the objectives of the research. It highlights the need for a comprehensive understanding of the subject matter and the role of the researcher in this process.

The second part of the paper focuses on the methodology used in the study. It details the research design, data collection methods, and the analytical techniques employed to interpret the findings.

The third part of the paper presents the results of the study. It provides a detailed analysis of the data collected and discusses the implications of the findings for the field of study.

The fourth part of the paper discusses the conclusions drawn from the study. It summarizes the key findings and offers suggestions for future research in this area.

The fifth part of the paper provides a final summary of the study. It reiterates the main points and emphasizes the significance of the research for the broader academic community.

The sixth part of the paper includes a list of references. It cites the works of other researchers in the field, providing a foundation for the current study and allowing for further exploration of the topic.

The seventh part of the paper contains a list of appendices. These additional materials provide further detail and support for the main text, including raw data, supplementary analyses, and other relevant information.

The eighth part of the paper includes a list of figures and tables. These visual aids help to present complex data in a clear and concise manner, making it easier for the reader to understand the results of the study.

The ninth part of the paper contains a list of footnotes. These provide additional information and clarification on specific points mentioned in the main text, ensuring that the reader has a complete understanding of the study.

The tenth part of the paper includes a list of acknowledgments. This section expresses gratitude to the individuals and organizations that provided support and assistance throughout the research process.



# Chapter 2 Part C:

## 1.9 and 2.0 litre diesel engine (DW series)

### in-car repair procedures

## Contents

Section number	Section number
Camshaft and followers – removal, inspection and refitting . . . . .	11
Camshaft oil seal – renewal . . . . .	10
Compression and leakdown tests – description and interpretation . . . . .	2
Crankshaft oil seals – renewal . . . . .	17
Crankshaft pulley – removal and refitting . . . . .	5
Cylinder head (1.9 litre engines) – removal and refitting . . . . .	13
Cylinder head (2.0 litre engines) – removal and refitting . . . . .	See Chapter 2E
Cylinder head cover – removal and refitting . . . . .	4
Engine assembly/valve timing holes – general information and usage . . . . .	3
Engine oil and filter renewal . . . . .	See Chapter 1B
Engine oil cooler – removal and refitting . . . . .	16
Engine oil level check . . . . .	See <i>Weekly checks</i>
Engine/transmission mountings – inspection and renewal . . . . .	20
Flywheel – removal, inspection and refitting . . . . .	19
General information . . . . .	1
Oil level and pressure sensors – general . . . . .	18
Oil pump – removal, inspection and refitting . . . . .	15
Sump – removal and refitting . . . . .	14
Timing belt (1.9 litre engines) – general information, removal and refitting . . . . .	7
Timing belt (2.0 litre engines) – general information, removal and refitting . . . . .	8
Timing belt covers – removal and refitting . . . . .	6
Timing belt sprockets and idler/tensioner pulleys – removal, inspection and refitting . . . . .	9
Valve clearances – checking and adjustment . . . . .	12

## Degrees of difficulty

**Easy**, suitable for novice with little experience



**Fairly easy**, suitable for beginner with some experience



**Fairly difficult**, suitable for competent DIY mechanic



**Difficult**, suitable for experienced DIY mechanic



**Very difficult**, suitable for expert DIY or professional



## Specifications

### Engine (general)

#### Designation:

1.9 litre (1868 cc) engines . . . . .	DW8
2.0 litre (1997 cc) engines . . . . .	DW10

#### Engine codes\*:

##### 1.9 litre engines:

Engines with mechanical injection pump . . . . .	WJZ (DW8)
Engines with electronically controlled injection pump . . . . .	WJY (DW8B)
2.0 litre engines . . . . .	RHY (DW10TD)

#### Bore:

1.9 litre engines . . . . .	82.2 mm
2.0 litre engines . . . . .	85.0 mm

#### Stroke

. . . . .	88.00 mm
-----------	----------

#### Direction of crankshaft rotation

Clockwise (viewed from right-hand side of vehicle)

#### No 1 cylinder location

At transmission end of block

#### Compression ratio:

1.9 litre engines . . . . .	23 : 1
2.0 litre engines . . . . .	17.6 : 1

\* The engine code is stamped on front of the cylinder block, just to the left of the oil filter/cooler.

The code given in brackets is the factory identification number.

### Compression pressures (engine hot, at cranking speed)

Normal . . . . .	25 to 30 bars (363 to 435 psi)
Maximum difference between any two cylinders . . . . .	5 bars (73 psi)

**Camshaft**

Drive .....	Toothed belt
No of bearings:	
1.9 litre engines .....	3
2.0 litre engines .....	5
Endfloat:	
1.9 litre engines .....	0.02 to 0.07 mm
2.0 litre engines .....	0.07 to 0.38 mm

**Valve clearances (engine cold)**

1.9 litre engines:	
Inlet .....	0.15 ± 0.07 mm
Exhaust .....	0.30 ± 0.07 mm
2.0 litre engines .....	Automatically adjusted by hydraulic tappets

**Lubrication system**

Oil pump type .....	Gear-type, chain-driven off the crankshaft right-hand end
Minimum oil pressure at 80°C:	
1.9 litre engines .....	4.5 bar at 4000 rpm
2.0 litre engines .....	4 bar at 4000 rpm

**Torque wrench settings**

	Nm	lbf ft
Big-end bearing cap nuts:*		
Stage 1 .....	20	15
Stage 2 .....	Angle-tighten a further 70°	
Camshaft:		
Bearing cap nuts – 1.9 litre engines .....	20	15
Bearing cap casting bolts – 2.0 litre engines .....	10	7
Camshaft sprocket:		
Hub-to-camshaft bolt .....	43	32
Sprocket-to-hub bolts:		
1.9 litre engines .....	23	17
2.0 litre engines .....	20	15
Crankshaft right-hand (timing belt end) oil seal housing bolts .....	14	10
Crankshaft pulley bolt:		
1.9 litre engines .....	10	7
2.0 litre engines (see text – Section 5):		
Early type pulley without green paint mark:		
Stage 1 .....	50	37
Stage 2 .....	Angle-tighten a further 62°	
Later type pulley with green paint mark:		
Stage 1 .....	70	52
Stage 2 .....	Angle-tighten a further 60°	
Crankshaft sprocket bolt – 1.9 litre engines:		
Stage 1 .....	40	30
Stage 2 .....	Angle-tighten a further 55°	
Cylinder head bolts:		
1.9 litre engines:		
Stage 1 .....	20	15
Stage 2 .....	60	44
Stage 3 .....	Angle-tighten a further 180°	
2.0 litre engines:		
Stage 1 .....	20	15
Stage 2 .....	60	44
Stage 3 .....	Angle-tighten a further 220°	
Cylinder head cover bolts:		
1.9 litre engines:		
Upper cover bolts .....	10	7
Lower cover bolts .....	5	4
2.0 litre engines .....	10	7
Engine-to-transmission fixing bolts .....	50	37
Engine/transmission left-hand mounting:		
Centre nut .....	65	48
Mounting bracket-to-body bolts .....	25	18
Mounting rubber nuts/bolts .....	25	18
Mounting stud to bracket .....	50	37
Mounting bracket to transmission .....	60	44

Torque wrench settings (continued)	Nm	lbf ft
Engine/transmission rear mounting:		
Connecting link-to-mounting rubber nut/bolt .....	50	37
Connecting link-to-subframe nut/bolt .....	50	37
Mounting assembly-to-block bolts .....	45	33
Engine/transmission right-hand mounting:		
1.9 litre engines:		
Engine bracket to cylinder block/head .....	45	33
Movement restrictors .....	45	45
Rubber mounting to body .....	45	33
Upper bracket to engine bracket .....	45	33
Upper bracket to rubber mounting .....	45	33
2.0 litre engines:		
Domed buffer nut .....	20	15
Engine bracket bolts:		
M8 bolts .....	20	15
M10 bolts .....	45	33
Rubber mounting to body .....	45	33
Stiffener bracket bolts .....	22	16
Upper bracket to engine bracket .....	61	45
Upper bracket to rubber mounting .....	45	33
Flywheel bolts* .....	48	35
Fuel filter/thermostat housing bolts – 1.9 litre engines .....	15	11
Fuel filter plastic housing bolt – 1.9 litre engines .....	18	13
Injection pump sprocket:		
Sprocket-to-hub bolts – 1.9 litre engines .....	23	17
Sprocket nut – 2.0 litre engines .....	50	37
Main bearing cap bolts:		
1.9 litre engines .....		
2.0 litre engines:		
Stage 1 .....	25	18
Stage 2 .....	Angle-tighten a further 60°	
Oil cooler centre bolt .....	50	37
Oil pump mounting bolts .....	16	12
Piston oil jet spray tube bolt .....	10	7
Roadwheel bolts .....	85	63
Sump bolts .....	16	12
Sump drain plug .....	34	25
Thermostat housing fixings – 2.0 litre engines:		
Housing studs .....	25	18
Retaining nuts and bolts .....	20	15
Timing belt cover bolts .....	8	6
Timing belt tensioner pulley bolt .....	23	17
Timing belt idler pulley bolt .....	43	32

\* New nuts/bolts must be used.

## 1 General information

### How to use this Chapter

This Part of Chapter 2 describes those repair procedures that can reasonably be carried out on the engine while it remains in the car. If the engine has been removed from the car and is being dismantled, as described in Part E, any preliminary dismantling procedures can be ignored.

Note that, while it may be possible physically to overhaul items such as the piston/connecting rod assemblies while the engine is in the car, such tasks are not normally carried out as separate operations. Usually, several additional procedures (not to

mention the cleaning of components and of oilways) have to be carried out. For this reason, all such tasks are classed as major overhaul procedures, and are described in Part E of this Chapter.

Part E describes the removal of the engine/transmission from the vehicle, and the full overhaul procedures that can then be carried out.

### Engine description

The DW series engine is a relatively new power unit based on the well-proven XUD series engine which has appeared in many Peugeot and Citroën vehicles. The engine is of four-cylinder single overhead camshaft design, mounted transversely, with the transmission mounted on the left-hand side.

The crankshaft runs in five main bearings of the usual shell type. Endfloat is controlled by

thrustwashers either side of No 2 main bearing.

The connecting rods rotate on horizontally-split bearing shells at their big-ends. The pistons are attached to the connecting rods by gudgeon pins, which are secured in position with circlips. The aluminium-alloy pistons are fitted with three piston rings – two compression rings and an oil control ring.

The cylinder block is made from cast-iron, and the cylinder bores are an integral part of the cylinder block. On this type of engine, the cylinder bores are sometimes referred to as having dry liners.

The camshaft is driven by a toothed timing belt which also operates the coolant pump. On 1.9 litre engines, the camshaft operates the eight valves via bucket-type followers; valve clearances are adjusted by shims fitted between the valve stem and follower.



On 2.0 litre engines, the camshaft operates the valves via followers and hydraulic tappets which automatically adjust the valve clearances. On all engines the camshaft runs in bearing caps which are bolted to the top of the cylinder head. The inlet and exhaust valves are each closed by coil springs, and operate in guides pressed into the cylinder head.

Lubrication is by means of an oil pump, which is driven (via a chain and sprocket) off the right-hand end of the crankshaft. It draws oil through a strainer located in the sump, and then forces it through an externally-mounted filter into galleries in the cylinder block/crankcase. From there, the oil is distributed to the crankshaft (main bearings) and camshaft. The big-end bearings are supplied with oil via internal drillings in the crankshaft, while the camshaft bearings also receive a pressurised supply. The camshaft lobes and valves are lubricated by splash, as are all other engine components. An oil cooler is mounted between the oil filter and cylinder block to keep the oil temperature stable under arduous operating temperatures.

### Repair operations – precaution

The 2.0 litre engine is a complex unit with numerous accessories and ancillary components. The design of the engine compartment is such that every conceivable space has been utilised, and access to virtually all of the engine components is extremely limited. In many cases, ancillary components will have to be removed, or moved to one side, and wiring, pipes and hoses will have to be disconnected or removed from various cable clips and support brackets.

When working on this engine, read through the entire procedure first, look at the vehicle and engine at the same time, and establish whether you have the necessary tools, equipment, skill and patience to proceed. Allow considerable time for any operation, and be prepared for the unexpected. Any major work on this engine is not for the faint-hearted!

Because of the limited access, many of the engine photographs appearing in this Chapter were, by necessity, taken with the engine removed from the vehicle.



**Warning:** It is essential to observe strict precautions when working on the fuel system components of the 2.0 litre engine, particularly the high pressure side of the system. Before carrying out any engine operations that entail working on, or near, any part of the fuel system, refer to the precautionary information given in Chapter 4C, Section 1.

### Operations with engine in car

The following work can be carried out with the engine in the car:

- a) Compression and leakdown tests.
- b) Cylinder head cover – removal and refitting.

- c) Timing belt covers – removal and refitting.
- d) Timing belt – removal, refitting and adjustment.
- e) Timing belt sprockets and tensioner/idler pulleys – removal and refitting.
- f) Camshaft oil seal – renewal.
- g) Camshaft and followers – removal, inspection and refitting.
- h) Cylinder head (1.9 litre engines) – removal and refitting\*.
- i) Cylinder head and pistons – decarbonising.
- j) Sump – removal and refitting.
- k) Oil pump – removal, overhaul and refitting.
- l) Crankshaft oil seals – renewal.
- m) Engine/transmission mountings – inspection and renewal.
- n) Flywheel – removal, inspection and refitting.

\* **Note:** On 2.0 litre engines, access between the cylinder head and engine compartment bulkhead, and to the rear underside of the engine is so restricted that it is impossible to remove the cylinder head with the engine in the car unless considerable additional dismantling is carried out first (eg, removal of the front suspension subframe and related components). Cylinder head removal and refitting procedures are therefore contained in Part E, assuming that the engine/transmission has been removed from the vehicle.

## 2 Compression and leakdown tests – description and interpretation

### Compression test

**Note:** A compression tester specifically designed for diesel engines must be used for this test, because of the high pressures involved.

1 When engine performance is down, or if misfiring occurs which cannot be attributed to the fuel system, a compression test can provide diagnostic clues as to the engine's condition. If the test is performed regularly, it can give warning of trouble before any other symptoms become apparent.

2 A compression tester specifically intended for diesel engines must be used, because of the higher pressures involved. The tester is connected to an adapter which screws into the glow plug or injector hole. On these engines, an adapter suitable for use in the glow plug holes will be required, so as not to disturb the fuel system components. It is unlikely to be worthwhile buying such a tester for occasional use, but it may be possible to borrow or hire one – if not, have the test performed by a garage.

3 Unless specific instructions to the contrary are supplied with the tester, observe the following points:

- a) The battery must be in a good state of charge, the air filter must be clean, and

the engine should be at normal operating temperature.

- b) All the glow plugs should be removed as described in Chapter 5C before starting the test.
- c) On 1.9 litre WJZ engines, the anti-theft system electronic engine immobiliser unit wiring connector at the rear of the injection pump must be disconnected.
- d) On 1.9 litre WJY engines and all 2.0 litre engines, the wiring connector on the engine management system ECU must be disconnected. Refer to Chapter 4C for further information.

4 Crank the engine on the starter motor; after one or two revolutions, the compression pressure should build-up to a maximum figure, and then stabilise. Record the highest reading obtained.

5 Repeat the test on the remaining cylinders, recording the pressure in each.

6 All cylinders should produce very similar pressures; a difference of more than 5 bars between any two cylinders indicates a fault. Note that the compression should build-up quickly in a healthy engine; low compression on the first stroke, followed by gradually-increasing pressure on successive strokes, indicates worn piston rings. A low compression reading on the first stroke, which does not build-up during successive strokes, indicates leaking valves or a blown head gasket (a cracked head could also be the cause). Deposits on the undersides of the valve heads can also cause low compression.

7 As a guide, any cylinder pressure of below 20 bars can be considered as less than healthy. Refer to a Peugeot/Citroën dealer or other specialist if in doubt as to whether a particular pressure reading is acceptable.

8 The cause of poor compression is less easy to establish on a diesel engine than on a petrol one. The effect of introducing oil into the cylinders ('wet' testing) is not conclusive, because there is a risk that the oil will sit in the swirl chamber or in the recess on the piston crown instead of passing to the rings. A low reading from two adjacent cylinders is almost certainly due to the head gasket having blown between them; the presence of coolant in the engine oil will confirm this.

### Leakdown test

9 A leakdown test measures the rate at which compressed air fed into the cylinder is lost. It is an alternative to a compression test, and in many ways it is better, since the escaping air provides easy identification of where pressure loss is occurring (piston rings, valves or head gasket).

10 The equipment needed for leakdown testing is unlikely to be available to the home mechanic. If poor compression is suspected, have the test performed by a suitably-equipped garage.

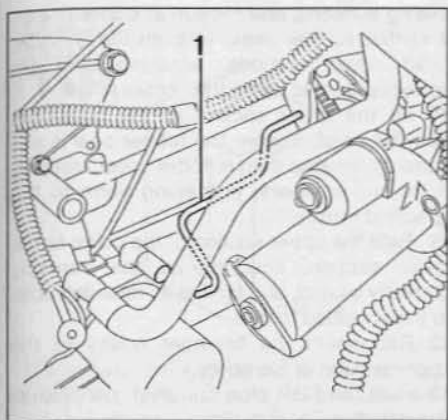

**3.4** Insert the bolt/drill (special tool shown - 1) in through the hole in the cylinder block flange (shown with the starter motor moved forwards for clarity) and locate it in the rear of the flywheel

### 3 Engine assembly/valve timing holes - general information and usage

**Note:** Do not attempt to rotate the engine whilst the crankshaft/camshaft/injection pump (as applicable) are locked in position. If the engine is to be left in this state for a long period of time, it is a good idea to place suitable warning notices inside the vehicle, and in the engine compartment. This will reduce the possibility of the engine being accidentally cranked on the starter motor, which is likely to cause damage with the locking pins in place.

#### 1.9 litre engines

**1** Timing holes are drilled in the camshaft sprocket hub, injection pump sprocket hub and flywheel. The holes are used to align the crankshaft, camshaft and injection pump, and to prevent the possibility of the valves contacting the pistons when refitting the cylinder head, and to ensure the valve timing/injection pump timing is correct when refitting the timing belt. When the holes are aligned with their corresponding holes in the cylinder head and cylinder block (as appropriate), suitable diameter bolts/pins can be inserted to lock the camshaft, injection pump and crankshaft in position, preventing them from rotating unnecessarily. Proceed as follows.

**2** Remove the timing belt upper and intermediate covers as described in Section 6 to gain access to the sprockets.

**3** Using a suitable socket and extension bar, turn the crankshaft by means of the pulley bolt, until the holes in the camshaft and injection pump sprocket hubs are aligned with the corresponding holes in the cylinder head/pump. Note that the crankshaft must always be turned in a clockwise direction (viewed from the right-hand side of vehicle).

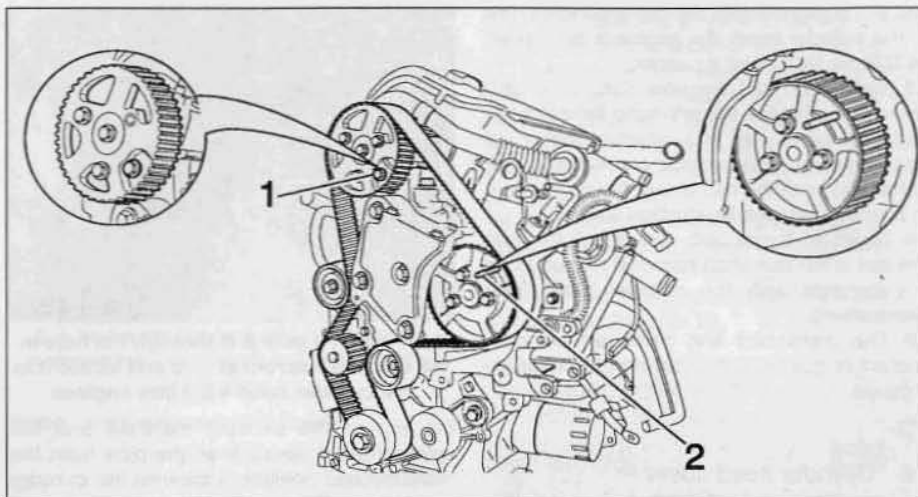

**3.5** Peg the camshaft and injection pump sprockets in position by inserting bolts/drills (1 and 2) - 1.9 litre engines

**4** With the camshaft sprocket hole correctly positioned, insert an 8 mm diameter bolt or drill through the hole in the front, left-hand flange of the cylinder block, located behind the starter motor, and locate it in the timing hole in the rear of the flywheel (see illustration). Note that it may be necessary to rotate the crankshaft slightly, to get the holes to align.

**5** With the flywheel correctly positioned, lock the camshaft sprocket in position by inserting an 8 mm diameter bolt or a drill through the timing hole in the sprocket hub, and locating it in the hole in the cylinder head (see illustration).

**6** Lock the injection pump sprocket in position by inserting a 6 mm diameter bolt or a drill through the timing hole in the sprocket hub and locating it in the hole in the pump.

**7** The crankshaft, camshaft and injection pump are now locked in position, preventing unnecessary rotation.

#### 2.0 litre engines

**8** Timing holes or slots are located in the flywheel and in the camshaft sprocket or sprocket hub. The holes/slots are used to align the crankshaft and camshaft at the TDC position for Nos 1 and 4 pistons. This will ensure that the valve timing is maintained during operations that require removal and

refitting of the timing belt and, on later engines, the crankshaft pulley. When the holes/slots are aligned with their corresponding holes in the cylinder block and cylinder head, suitable diameter bolts/pins can be inserted to lock the crankshaft and camshaft in position, preventing rotation.

**9** The HDi type fuel system used on these engines does not have a conventional diesel injection pump, but instead uses a high-pressure fuel pump that does not have to be timed. The alignment of the fuel pump sprocket (and hence the fuel pump itself) with respect to crankshaft and camshaft position is therefore irrelevant.

**10** To align the engine assembly/valve timing holes, proceed as follows.

**11** Remove the upper timing belt cover as described in Section 6.

**12** Using a suitable socket and extension bar, turn the crankshaft by means of the pulley bolt, until the timing slot in the camshaft sprocket hub is aligned with the corresponding hole in the cylinder head. Note that the crankshaft must always be turned in a clockwise direction (viewed from the right-hand side of vehicle). Use a small mirror so that the position of the sprocket hub timing slot can be observed (see illustrations). When



**3.12a** Use a mirror to observe the camshaft sprocket hub timing slot - 2.0 litre engines

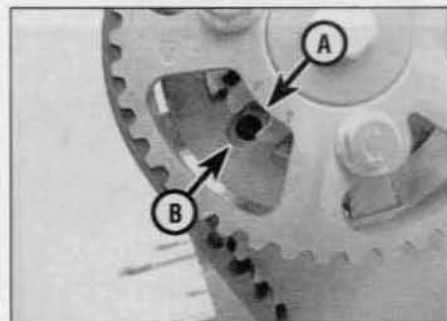

**3.12b** Camshaft sprocket hub timing slot (A) aligned with the cylinder head timing hole (B) - 2.0 litre engines



the slot is aligned with the corresponding hole in the cylinder head, the engine is positioned at TDC for Nos 1 and 4 pistons.

**13** Insert an 8 mm diameter bolt, rod or drill through the hole in the left-hand flange of the cylinder block by the starter motor; if necessary, carefully turn the crankshaft a little either way until the rod enters the timing hole in the flywheel (see illustration 3.4).

**14** Insert an 8 mm bolt, rod or drill through the slot in the camshaft sprocket hub and into engagement with the cylinder head (see illustration).

**15** The crankshaft and camshaft are now locked in position, preventing unnecessary rotation.

#### 4 Cylinder head cover – removal and refitting



##### 1.9 litre engines

###### Removal

**1** Release the fasteners from the right-hand side and top of the engine cover then lift off the cover, taking care not to lose its mounting rubbers (see illustrations). Disconnect the battery negative terminal (refer to *Disconnecting the battery* in the Reference Chapter).

**2** Remove the upper section of the inlet manifold as described in Chapter 4C.

**3** Unscrew the bolts securing the EGR pipe to

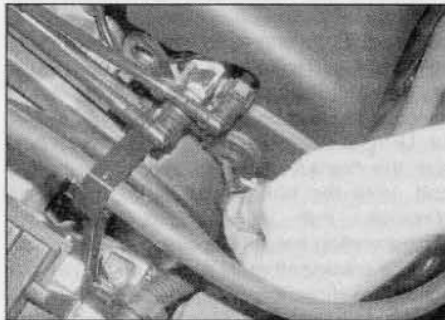

4.1a Remove the fasteners from the right-hand side ...



4.1c ... then remove the cover from the engine – 1.9 litre engines

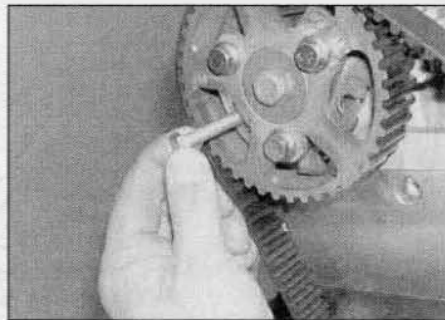

3.14 Insert a bolt/drill through the hole in the camshaft sprocket hub and locate it in the cylinder head – 2.0 litre engines

the top of the exhaust manifold and the cylinder head cover. Free the pipe from the manifold and position it clear of the cylinder head cover. Recover the gasket and discard it; a new one should be used on refitting.

**4** Slacken the retaining clips and disconnect the breather hoses from the upper section of the cylinder head cover.

**5** Unscrew the eight retaining bolts then lift off the upper section of the cylinder head cover, complete with its rubber seal.

**6** Unscrew the three retaining bolts and washers then remove the lower section of the cylinder head cover, complete with its rubber seal.

**7** Inspect the cover seals for signs of damage or deterioration and, if necessary, renew.

###### Refitting

**8** Carefully clean the cylinder head and cover



4.1b ... and top of the engine cover ...

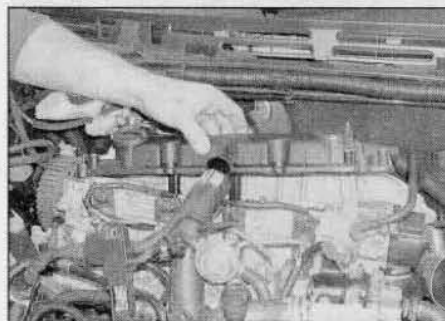

4.19 Removing the cylinder head cover – 2.0 litre engines

removal surfaces, and remove all traces of oil.

**9** Fit the rubber seals to both the cylinder head cover sections, ensuring they are correctly located along their entire length.

**10** Fit the lower section of the cover to the cylinder head. Ensure the rubber seal is still correctly located then refit the cover retaining bolts and washers, tightening them to the specified torque.

**11** Refit the upper section of the cover to the lower section, ensuring its seal remains correctly seated, and tighten its retaining bolts to the specified torque.

**12** Reconnect the breather hoses to the upper section of the cover.

**13** Refit the EGR pipe and inlet manifold as described in Chapter 4C.

##### 2.0 litre engines

###### Removal

**14** Remove the timing belt upper cover as described in Section 6.

**15** Slacken or release the clips securing the crankcase ventilation hoses to the centre and left-hand end of the cylinder head cover and disconnect the hoses.

**16** Undo the bolts as necessary and move the engine cover and cable guide support bracket clear of the right-hand end of the cylinder head cover.

**17** Disconnect the camshaft position sensor wiring connector.

**18** Release the wiring harness from the clip on the cylinder head cover and move the harness to one side.

**19** Undo the bolts securing the cylinder head cover to the camshaft carrier and collect the washers. Carefully lift off the cover taking care not to damage the camshaft position sensor as the cover is removed (see illustration). Recover the seal from the cover.

###### Refitting

**20** Refitting is a reversal of removal, bearing in mind the following points:

- Examine the cover seal for signs of damage and deterioration, and renew if necessary.
- Tighten the cylinder head cover bolts to the specified torque.
- On early engines with a two-piece camshaft sprocket (see Section 9), adjust the camshaft position sensor air gap as described in Chapter 4C before refitting the upper timing belt cover.

#### 5 Crankshaft pulley – removal and refitting



##### Removal – 1.9 litre engines

**1** Remove the auxiliary drivebelt as described in Chapter 1B.

**2** Undo the four crankshaft pulley retaining bolts and remove the pulley, noting which way round it is fitted.

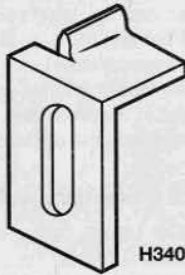

**TOOL TIP**

H34034

A flywheel ring gear locking tool can be made from a short strip of steel bent to form a right-angle. Cut a slot in the upper part and bend this part up to engage with the ring gear teeth. File the edges to form a tooth profile. Drill a hole in the lower part to enable the tool to be bolted to the bellhousing flange.

**Refitting – 1.9 litre engines**

**3** Fit the pulley to the end of the crankshaft, ensuring it is fitted the correct way round. Apply locking compound (Peugeot/Citroën recommend the use of Loctite Frenetanch) to the retaining bolt threads, then refit and tighten the bolts to the specified torque.

**4** Refit and tension the auxiliary drivebelt as described in Chapter 1B.

**Removal – 2.0 litre engines**

**5** Remove the auxiliary drivebelt as described in Chapter 1B.

**6** It is now necessary to determine the type of pulley fitted, as there are two different removal and refitting procedures accordingly.

**7** From under the wheel arch, observe the flat front face of the pulley. If there is a green paint mark on the pulley face it is of the later type. If no paint mark is present, the pulley is an early type. Proceed as described in the appropriate following sub-sections, according to pulley type.

**Pulley without green paint mark**

**8** To prevent crankshaft rotation whilst the pulley retaining bolt is being slackened, the flywheel ring gear must be locked using a suitable tool made from steel angle (see **Tool Tip**). Release the power steering fluid pipes from the clamps on the cover plate at the base of the transmission bellhousing. Remove the cover plate from the bellhousing and bolt the tool to the lower bolt hole in the bellhousing flange so it engages with the ring gear teeth.

**9** Using a suitable socket and extension bar, unscrew the retaining bolt, remove the washer, then slide the pulley off the end of the crankshaft (see **illustration**). If the pulley is a tight fit, it can be drawn off the crankshaft using a suitable puller. If a puller is being used, refit the pulley retaining bolt without the washer, to avoid damaging the crankshaft as the puller is tightened.

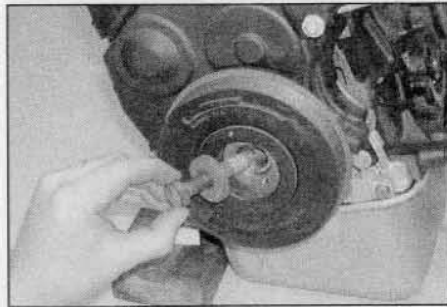

**5.9** Unscrew the bolt and washer and remove the crankshaft pulley – 2.0 litre engines

**Pulley with green paint mark**

**10** Align the engine assembly/valve timing holes as described in Section 3, and lock the crankshaft and the camshaft sprocket in position. The crankshaft timing belt sprocket used with the later type pulley incorporates a wider keyway for the locating Woodruff key. When the pulley retaining bolt is slackened, the sprocket is free to turn on the crankshaft within the limits afforded by the wider keyway. This provides a certain degree of lateral movement of the sprocket for accurate adjustment of the timing belt tension. It is therefore essential that the flywheel and camshaft are locked in the engine assembly/valve timing position when the pulley bolt is slackened, otherwise the sprockets will turn slightly and the valve timing will be lost.

**11** To prevent crankshaft rotation whilst the pulley retaining bolt is being slackened, make up and fit a flywheel ring gear locking tool as described in paragraph 8. Do not attempt to use only the engine assembly/valve timing locking tools to prevent rotation whilst the bolt is slackened.

**12** Using a suitable socket and extension bar, unscrew the retaining bolt, remove the washer, then slide the pulley off the end of the crankshaft. If the pulley is a tight fit, it can be drawn off the crankshaft using a suitable puller. If a puller is being used, refit the pulley retaining bolt without the washer, to avoid damaging the crankshaft as the puller is tightened.

**Refitting – 2.0 litre engines**

**13** If working on the later type pulley, ensure that the engine assembly/valve timing holes are still aligned as described in Section 3, and the crankshaft and camshaft sprocket are locked in position.

**14** Locate the pulley in position on the end of the crankshaft.

**15** Thoroughly clean the threads of the pulley retaining bolt, then apply a coat of locking compound to the bolt threads (Peugeot/Citroën recommend the use of Loctite Frenetanch).

**16** Refit the crankshaft pulley retaining bolt and washer. Tighten the bolt to the specified torque, then through the specified angle, preventing the crankshaft from turning using the tool employed for removal. Note that

different torque and angle settings are given in the Specifications, according to pulley type.

**17** Remove the flywheel ring gear locking tool and, where applicable, the crankshaft and camshaft sprocket locking tools.

**18** Refit the cover plate to the transmission bellhousing and secure the power steering fluid pipes in position.

**19** If working on the later type pulley, refit the upper timing belt cover as described in Section 6.

**20** Refit and tension the auxiliary drivebelt as described in Chapter 1B.

**6 Timing belt covers – removal and refitting****1.9 litre engines****Upper cover removal**

**1** Disconnect the battery negative terminal (refer to *Disconnecting the battery* in the Reference Chapter).

**2** Release the clip in the centre of the engine cover and undo the retaining screw on the right-hand side. Lift off the engine cover (see **illustrations 4.1a to 4.1c**).

**3** Firmly apply the handbrake, then jack up the front of the vehicle and support it securely on axle stands (see *Jacking and vehicle support*). Remove the right-hand front roadwheel.

**4** To gain access to the right-hand end of the engine, the wheel arch plastic liner must be removed. The liner is secured by various screws and clips under the wheel arch. Release all the fasteners, and remove liner from under the front wing. Where necessary, unclip the coolant hoses from under the wing to improve access further.

**5** At the connections adjacent to the fuel pump, disconnect the fuel supply and return hose quick-release fittings using a small screwdriver to release the locking clip. Cover the open unions to prevent dirt entry, using small plastic bags, or fingers cut from clean rubber gloves.

**6** Release the two hoses from the retaining clips on the upper timing belt cover and move them to one side (see **illustration**).

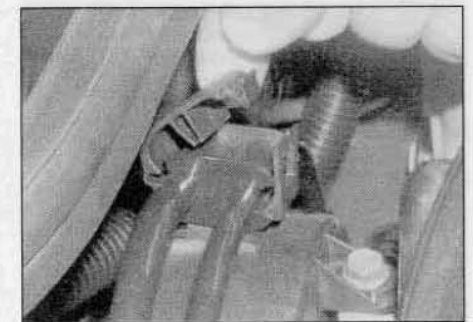

**6.6** Unclip the fuel pipes from the top of the timing belt covers – 1.9 litre engines

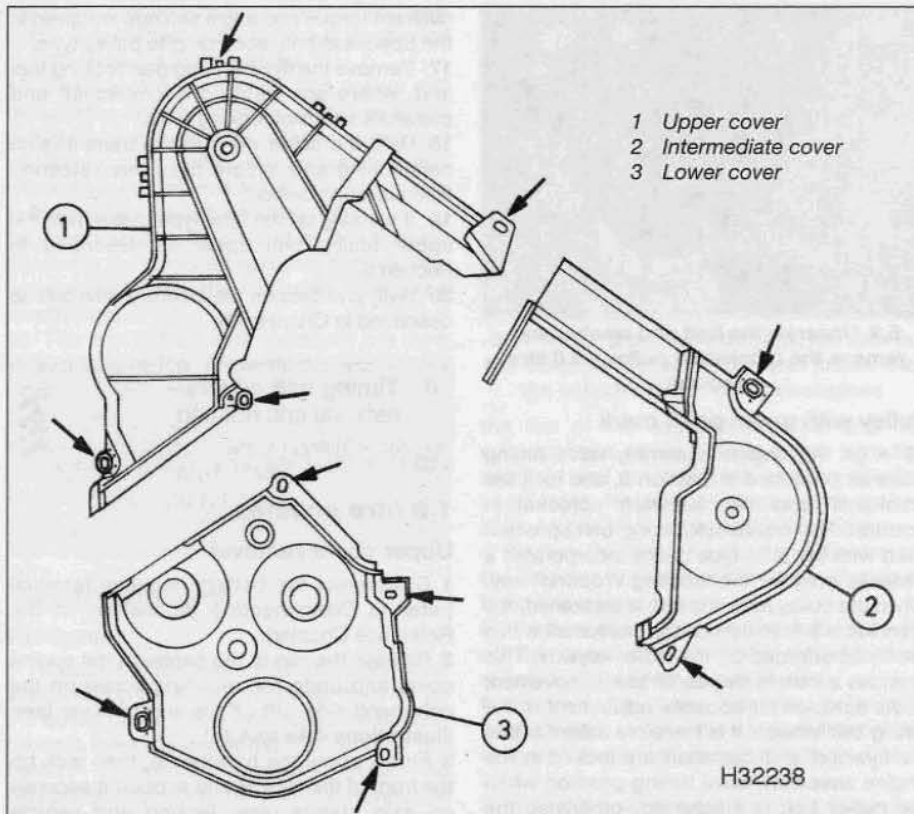

6.12 Timing belt cover retaining bolt locations (arrowed) – 1.9 litre engines

7 Connect an engine hoist or suitable lifting gear to the two lifting brackets on the cylinder head. Raise the hoist to just take the weight of the engine.

8 For additional stability, place a jack beneath the right-hand side of the engine, with a block of wood on the jack head. Raise the jack until it is just contacting the sump.

9 Slacken and remove the three bolts securing the right-hand engine/transmission mounting upper bracket to the lower (engine) bracket. Unscrew the single nut securing the upper bracket to the rubber mounting. Remove the upper bracket from the rubber mounting and lower (engine) bracket.

10 Undo the two nuts and remove the through-bolts securing the rear engine/

transmission mounting connecting link to the mounting bracket on the subframe and on the rear of the cylinder block. Release and remove the connecting link from the mounting brackets.

11 With the two engine mountings removed, alternatively raise and lower the lifting gear and the jack under the engine, as necessary, for access to the timing belt cover retaining bolts.

12 Undo the bolt securing the upper cover to the cylinder head cover (see illustration).

13 Undo the two bolts at the joint between the upper cover and lower cover; one in the centre just below the engine mounting bracket, and one on the outer edge. Note that the bolt on the outer edge also retains the

coolant pump. To avoid coolant leakage, after the cover is removed, refit the bolt fitted with a 5.0 mm spacer, and tighten it securely.

14 Undo the remaining bolt directly above the injection pump sprocket.

15 Release the locating lugs, ease the upper section out from behind the intermediate cover and manipulate the upper cover from its location.

**Intermediate cover removal**

16 Remove the upper cover as described previously.

17 Undo the remaining bolt at the base of the cover just below the engine mounting bracket.

18 Release the locating lugs and manipulate the intermediate cover from its location.

**Lower cover removal**

19 Remove the upper and intermediate covers as described previously.

20 Remove the crankshaft pulley as described in Section 5.

21 Undo the two remaining bolts on the edge of the cover, one on either side of the crankshaft pulley location.

22 Lift the cover off the front of the engine.

**Refitting**

23 Refitting of all the covers is a reversal of the relevant removal procedure, ensuring that each cover section is correctly located, and that the cover retaining bolts are securely tightened. Ensure that all disturbed hoses are reconnected and retained by their relevant clips, and that all nuts/bolts are tightened to their specified torque wrench settings (where given). On completion, prime and bleed the fuel system as described in Chapter 4C.

**2.0 litre engines**



**Warning:** Refer to the precautionary information contained in Section 1 before proceeding.

**Upper cover removal**

24 Disconnect the battery negative terminal (refer to *Disconnecting the battery* in the Reference Chapter).

25 Turn the four plastic fasteners through 90° and lift off the engine cover (see illustrations).

26 Firmly apply the handbrake, then jack up the front of the vehicle and support it securely on axle stands (see *Jacking and vehicle support*). Remove the right-hand front roadwheel.

27 To gain access to the right-hand end of the engine, the wheel arch plastic liner must be removed. The liner is secured by various screws and clips under the wheel arch. Release all the fasteners, and remove liner from under the front wing. Where necessary, unclip the coolant hoses from under the wing to improve access further.

28 At the connections adjacent to the fuel pump, disconnect the fuel supply and return hose quick-release fittings using a small

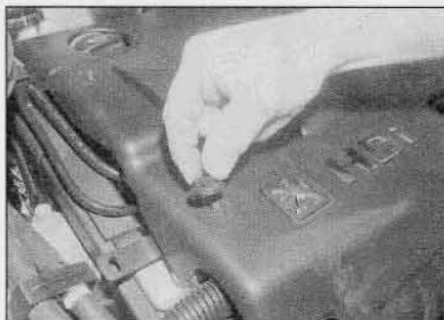

6.25a Rotate each fastener 90° to release it . . .

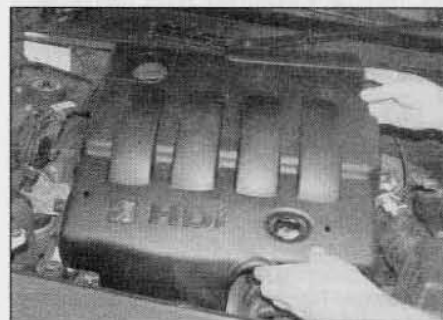

6.25b . . . then lift off the engine cover – 2.0 litre engines





**6.28** Disconnect the fuel supply and return hose quick-release fittings – 2.0 litre engines

screwdriver to release the locking clip (see illustration). Cover the open unions to prevent dirt entry, using small plastic bags, or fingers cut from clean rubber gloves.

**29** Release the two hoses from the retaining clips on the upper timing belt cover and move them to one side (see illustration).

**30** On early engines, undo the EGR solenoid valve mounting bracket bolt and move the valve to one side.

**31** Undo the two bolts securing the right-hand mounting stiffener bracket to the body and lift off the bracket, complete with the accelerator pedal position sensor on later engines (see illustration).

**32** Connect an engine hoist or suitable lifting gear to the two lifting brackets on the cylinder head. Raise the hoist to just take the weight of the engine. For additional stability, place a jack beneath the right-hand side of the engine, with a block of wood on the jack head. Raise the jack until it is just contacting the sump.

**33** Slacken and remove the three bolts securing the right-hand engine/transmission mounting upper bracket to the lower (engine) bracket.



**6.29** Release the two hoses from the retaining clips on the upper timing belt cover – 2.0 litre engines

**34** Unscrew the domed buffer nut, then unscrew the single nut securing the upper bracket to the rubber mounting. Remove the upper bracket from the rubber mounting and lower (engine) bracket.

**35** Undo the two nuts and remove the through-bolts securing the rear engine/transmission mounting connecting link to the mounting bracket on the subframe and on the rear of the cylinder block. Release and remove the connecting link from the mounting brackets.

**36** With the two engine mountings removed, alternatively raise and lower the lifting gear and the jack under the engine, as necessary, for access to the timing belt cover retaining bolts.

**37** Undo the bolt securing the upper cover to the cylinder head cover (see illustration).

**38** Undo the upper bolt on the edge of the cover nearest to the engine compartment bulkhead.

**39** Undo the lower bolt on the bulkhead side of the cover, at the join between the upper and lower covers. Note that this bolt also retains the coolant pump. To avoid coolant

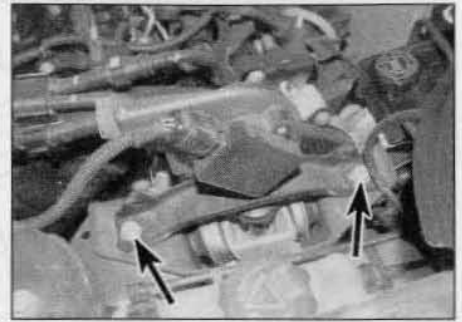

**6.31** Undo the two bolts (arrowed) and lift off the stiffener bracket and pedal position sensor – later 2.0 litre engines

leakage, after the upper cover is removed, refit the bolt fitted with a 17.0 mm spacer, and tighten it securely.

**40** Undo the remaining bolt in the centre of the cover, just above the engine mounting bracket.

**41** Disengage the upper cover from the intermediate cover and manipulate the upper cover from its location.

#### Intermediate cover removal

**42** Remove the upper cover as described previously.

**43** Undo the upper bolt on the top edge of the intermediate cover.

**44** Undo the two remaining bolts at the join between the intermediate cover and lower cover, then manipulate the intermediate cover from its location.

#### Lower cover removal

**45** Remove the crankshaft pulley as described in Section 5.

**46** Remove the upper and intermediate covers as described previously.

**47** Undo the two remaining bolts on the edge of the cover, one on either side of the crankshaft pulley location.

**48** Lift the cover off the front of the engine and manipulate it from its location.

#### Refitting

**49** Refitting of all the covers is a reversal of the relevant removal procedure, ensuring that each cover section is correctly located, and that the cover retaining bolts are securely tightened. Ensure that all disturbed hoses are reconnected and retained by their relevant clips, and that all nuts/bolts are tightened to their specified torque wrench settings (where given). On completion, prime and bleed the fuel system as described in Chapter 4C.

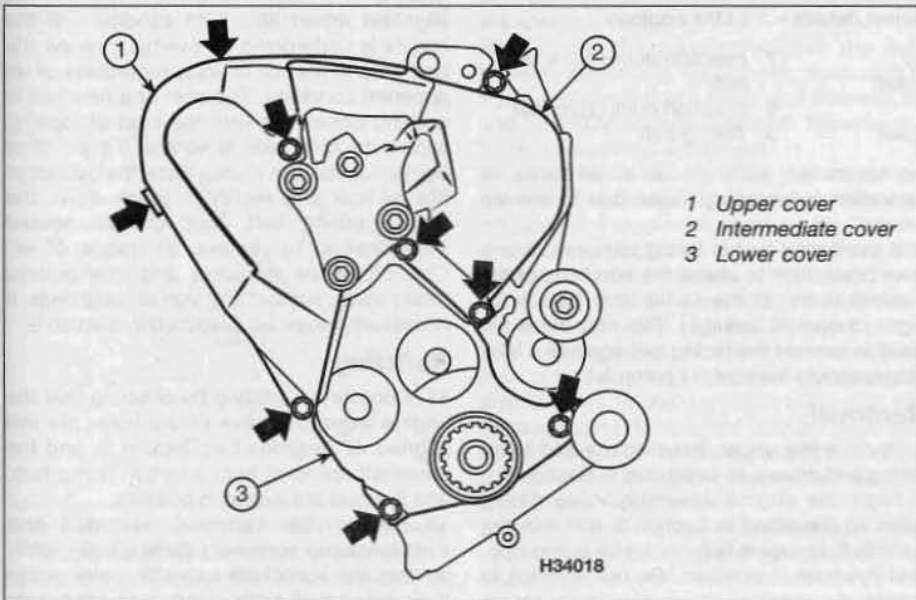

**6.37** Timing belt cover retaining bolt locations (arrowed) – 2.0 litre engines

#### 7 Timing belt (1.9 litre engines) – general information, removal and refitting

**Note:** The manufacturer's specify the use of a special electronic tool (SEEM C.TRONIC type 105 belt tensioning measuring tool, to correctly set the timing belt tension. The following procedure assumes that this equipment (or



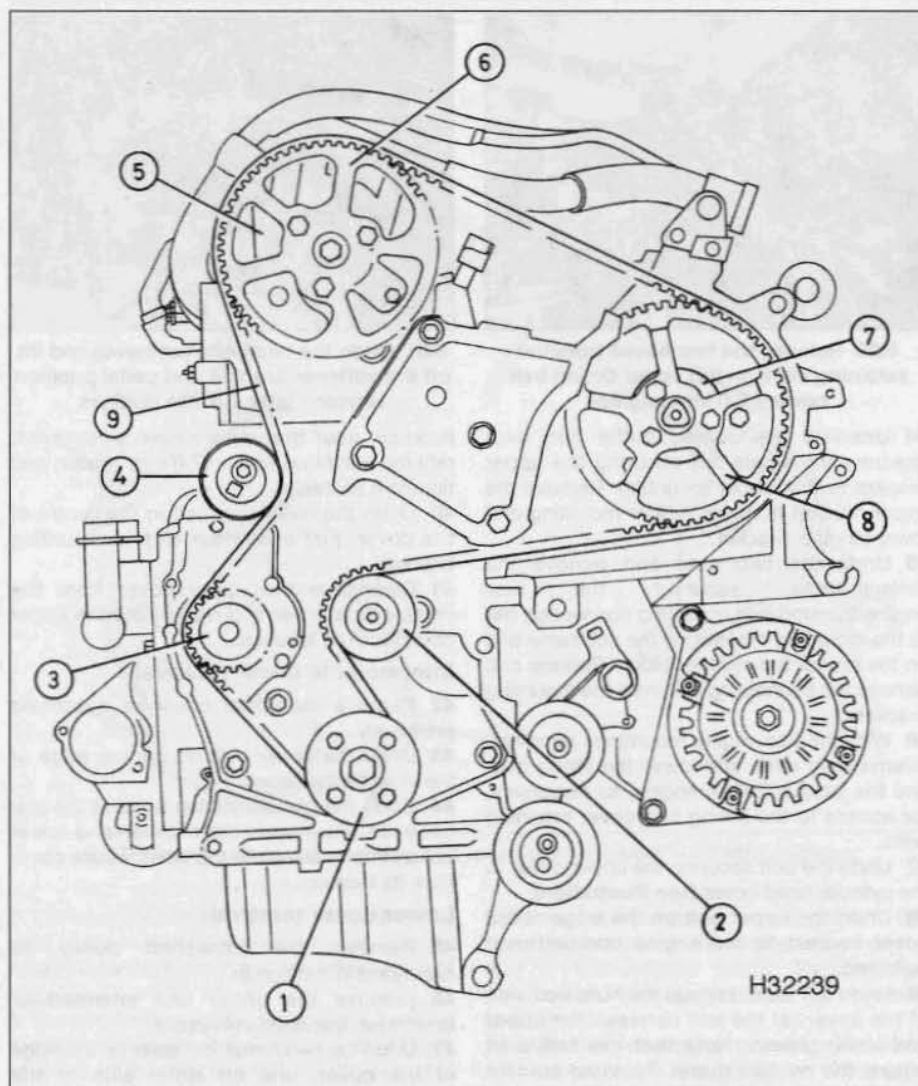

7.6 Timing belt, sprocket and tensioner details – 1.9 litre engines

- |                         |                         |                               |
|-------------------------|-------------------------|-------------------------------|
| 1 Crankshaft sprocket   | 4 Tensioner pulley      | 7 Injection pump sprocket hub |
| 2 Idler pulley          | 5 Camshaft sprocket hub | 8 Injection pump sprocket     |
| 3 Coolant pump sprocket | 6 Camshaft sprocket     | 9 Timing belt                 |

suitable alternative equipment calibrated to display belt tension in SEEM units) is available. Accurate tensioning of the timing belt is essential, and if the electronic equipment is not available, it is recommended that the work is entrusted to a Peugeot/Citroën dealer or suitably-equipped garage.

### General information

- The timing belt drives the camshaft, injection pump and coolant pump from a toothed sprocket on the right-hand end of the crankshaft. The belt also drives the brake vacuum pump indirectly via the flywheel end of the camshaft. If the belt breaks or slips in service, the pistons are likely to hit the valve heads, resulting in expensive damage.
- The timing belt should be renewed at the specified intervals, or earlier if it is

contaminated with oil, or at all noisy in operation (a 'scraping' noise due to uneven wear).

- If the timing belt is being removed, it is a wise precaution to check the condition of the coolant pump at the same time (check for signs of coolant leakage). This may avoid the need to remove the timing belt again at a later stage, should the coolant pump fail.

### Removal

- Remove the upper, intermediate and lower timing belt covers as described in Section 6.
- Align the engine assembly/valve timing holes as described in Section 3, and lock the camshaft sprocket hub, injection pump hub, and flywheel in position. Do not attempt to rotate the engine whilst the pins are in position.

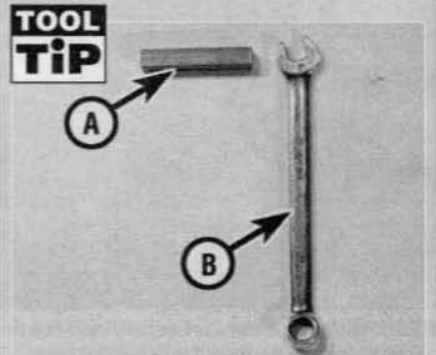

**TOOL TIP**  
If you're having difficulty finding a square-section tool that will fit the tensioner pulley, obtain a length of standard 8 mm door handle rod from a DIY shop and cut it to length (A). Insert the rod into the pulley hub and rotate the pulley with an 8 mm spanner (B).

- Slacken the three bolts securing the camshaft sprocket to the sprocket hub (see illustration).

- Similarly slacken the three bolts securing the injection pump sprocket to the pump hub.
- Loosen the timing belt tensioner pulley retaining bolt. Pivot the pulley in a clockwise direction, using a square-section key fitted to the hole in the pulley hub, then retighten the retaining bolt (see Tool Tip).

- If the timing belt is to be re-used, use white paint or chalk to mark the direction of rotation on the belt (if markings do not already exist), then slip the belt off the sprockets. Note that the crankshaft must not be rotated whilst the belt is removed.

- Check the timing belt carefully for any signs of uneven wear, split or oil contamination. Pay particular attention to the roots of the teeth. Renew it if there is the slightest doubt about its condition. If the engine is undergoing an overhaul, renew the belt as a matter of course, regardless of its apparent condition. The cost of a new belt is nothing compared with the cost of repairs, should the belt break in service. If signs of oil contamination are found, trace the source of the oil leak and rectify it. Wash down the engine timing belt area and all related components, to remove all traces of oil. Check that the tensioner and idler pulleys rotate freely, without any sign of roughness. If necessary, renew as described in Section 9.

### Refitting

- Commence refitting by ensuring that the engine assembly/valve timing holes are still aligned as described in Section 3, and the camshaft sprocket hub, injection pump hub, and flywheel are locked in position.
- Tighten the camshaft sprocket and injection pump sprocket retaining bolts lightly so that the sprockets can still move within their elongated slots. Turn both sprockets fully clockwise to the ends of the slots.

**13** Manoeuvre the timing belt into position, ensuring that the arrows on the belt are pointing in the direction of rotation (clockwise, when viewed from the right-hand end of the engine).

**14** Locate the belt on the crankshaft sprocket, taking care not to twist it sharply while refitting it, and route the belt round the idler pulley.

**15** Ensure the 'front run' of the belt is taut then align the belt with the injection pump sprocket. Rotate the sprocket anti-clockwise on its hub until the belt and sprocket teeth are correctly aligned then engage the belt on the sprocket. **Note:** Do not rotate the sprocket anti-clockwise any more than is necessary and never rotate it through more than one sprocket tooth of movement.

**16** Once the belt is correctly seated on the injection pump sprocket, ensure the belt 'front' and 'top' runs are taut then align the belt with the camshaft sprocket. Rotate the camshaft sprocket anti-clockwise on its hub until the belt and sprocket teeth are correctly aligned then engage the belt on the sprocket. **Note:** Do not rotate the sprocket anti-clockwise any more than is necessary and never rotate it through more than one sprocket tooth of movement.

**17** Ensure that any slack is on the tensioner pulley side of the belt then locate the belt over the coolant pump sprocket and behind the tensioner pulley.

**18** Ensure that the belt teeth are seated centrally in the sprockets then loosen the tensioner pulley retaining bolt. Pivot the pulley anti-clockwise to remove all free play from the timing belt, then retighten the bolt.

**19** Remove one of the sprocket bolts from both the injection pump and camshaft sprockets and check that the sprockets are not at the end of their retaining bolt slots (see illustration). If they are, the sprocket was rotated through more than one tooth of

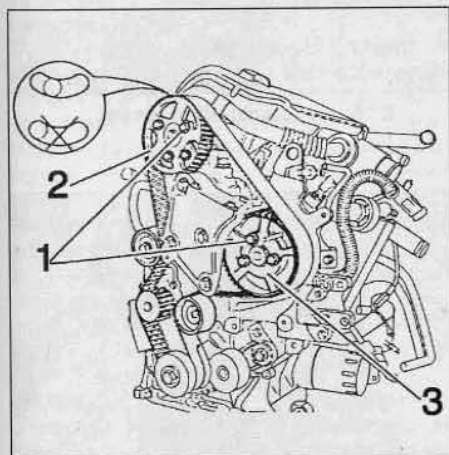

**7.19** Remove one of the bolts (1) from both the camshaft (2) and injection pump (3) sprockets and check that each sprocket is not at the end of its bolt slots (see inset) – 1.9 litre engines

movement whilst installing the belt; remove the timing belt and repeat the refitting procedure. If the sprockets are correctly positioned, tension the timing belt as follows.

**20** Fit the sensor head of the electronic belt tension measuring equipment to the 'top run' of the timing belt, approximately midway between the camshaft and injection pump sprockets.

**21** Pivot the tensioner pulley anti-clockwise until an initial setting of  $106 \pm 2$  SEEM units is displayed on the tension measuring equipment. Hold the tensioner pulley in that position and retighten the retaining bolt.

**22** Check that the sprockets have not been turned so far that the retaining bolts are at the end of their slots. If this is the case, repeat the refitting operation. If all is satisfactory, tighten the camshaft and injection pump sprocket retaining bolts to the specified torque.

**23** Remove the belt tension measuring equipment and the crankshaft, camshaft sprocket hub and injection pump hub locking tools.

**24** Rotate the crankshaft through eight complete rotations in a clockwise direction (viewed from the right-hand end of the engine). Realign the engine assembly/valve timing holes and refit the crankshaft, camshaft and injection pump locking tools.

**25** Slacken the camshaft and injection pump sprocket retaining bolts, retighten them finger-tight, then slacken them all by one sixth of a turn.

**26** Slacken the tensioner pulley retaining bolt once more. Refit the belt tension measuring equipment to the top run of the belt, and turn the tensioner pulley to give a final setting of  $42 \pm 2$  SEEM units on the tensioning gauge. Hold the tensioner pulley in this position and tighten the retaining bolt to the specified torque.

**27** Retighten all sprocket retaining bolts to the specified torque.

**28** Release the sensor head of the belt tension measuring equipment, then refit it again and check that a reading of between 38 and 46 SEEM units is indicated. Remove the tension measuring equipment.

**29** Remove the locking tools, then rotate the crankshaft once again through two complete rotations in a clockwise direction. Realign the engine assembly/valve timing holes and refit the crankshaft locking tool.

**30** Check that it is possible to insert the camshaft sprocket hub and injection pump hub locking tools. If the tools cannot be inserted, check that the offset between the timing holes in the sprocket hubs and the corresponding holes in the cylinder head and injection pump is not greater than 1.0 mm. If it is, repeat the complete timing belt refitting and tensioning procedure.

**31** Refit the lower, intermediate and upper timing belt covers as described in Section 6.

**32** Refit the crankshaft pulley as described in Section 5.

## 8 Timing belt (2.0 litre engines) – general information, removal and refitting

**Note:** The manufacturer's specify the use of a special electronic tool (SEEM C.TRONIC type 105 belt tensioning measuring tool, to correctly set the timing belt tension. The following procedure assumes that this equipment (or suitable alternative equipment calibrated to display belt tension in SEEM units) is available. Accurate tensioning of the timing belt is essential, and if the electronic equipment is not available, it is recommended that the work is entrusted to a Peugeot/Citroën dealer or suitably-equipped garage.

### General information

**1** The timing belt drives the camshaft, high-pressure fuel pump and coolant pump from a toothed sprocket on the end of the crankshaft. The belt also drives the brake servo vacuum pump indirectly via the flywheel end of the camshaft. If the belt breaks or slips in service, the pistons are likely to hit the valve heads, resulting in expensive damage.

**2** The timing belt should be renewed at the specified intervals, or earlier if it is contaminated with oil, or at all noisy in operation (a 'scraping' noise due to uneven wear).

**3** If the timing belt is being removed, it is a wise precaution to check the condition of the coolant pump at the same time (check for signs of coolant leakage). This may avoid the need to remove the timing belt again at a later stage, should the coolant pump fail.

**4** Two types of timing belt sprocket arrangements may be encountered. On early engines, the camshaft sprocket is of the 'floating' type, secured to the sprocket hub with three bolts. The bolt holes are elongated and allow for a certain degree of lateral movement of the sprocket for accurate tensioning of the timing belt when refitting. On later engines, the camshaft sprocket is fixed, but the crankshaft sprocket becomes the 'floating' component. Lateral movement of the crankshaft sprocket is achieved by using a wider keyway for the locating Woodruff key. Timing belt removal procedures are the same for both types, but different procedures must be used when refitting.

### Removal

**5** Remove the crankshaft pulley as described in Section 5. Refit and tighten the pulley retaining bolt to allow the engine to be turned in subsequent operations.

**6** Remove the upper, intermediate and lower timing belt covers as described in Section 6.

**7** It is now necessary to identify the type of timing belt sprocket arrangement fitted by observing the design of the camshaft sprocket. On early engines the sprocket and hub is a two-piece assembly. The sprocket is



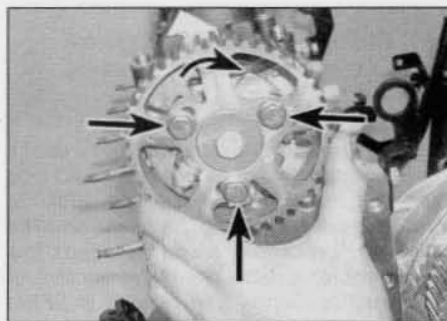

**8.9** On early engines, slacken the bolts (arrowed) and rotate the camshaft sprocket fully clockwise on its hub – 2.0 litre engines

secured to the sprocket hub by three retaining bolts, with the hub being secured to the camshaft by a single centre bolt. On later engines the sprocket and hub are a single fixed assembly secured to the camshaft by a centre retaining bolt only. When refitting, proceed as described in the appropriate sub-sections according to sprocket type.

**8** If not already done, align the engine assembly/valve timing holes as described in Section 3, and lock the crankshaft and the camshaft sprocket in position. *Do not* attempt to rotate the engine whilst the locking pins are in position.

**9** On early engines, slacken the three bolts securing the camshaft sprocket to the sprocket hub (see illustration).



**8.16a** Retain the timing belt on the crankshaft sprocket and feed it around the idler pulley ...

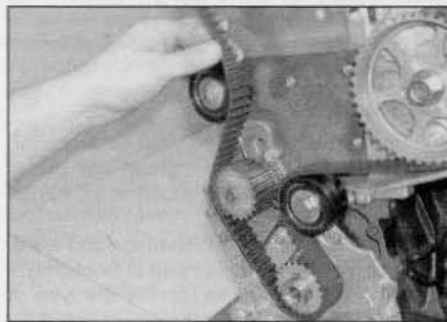

**8.16d** ... coolant pump and tensioner pulley – 2.0 litre engines

**10** Slacken the timing belt tensioner pulley retaining bolt and insert a short length of 8.0 mm square bar into the square hole on the front face of the tensioner pulley (see **Tool Tip** in Section 7). Alternatively, although clearance is restricted, the square end of a 1/4 inch drive socket bar can also be used. Using the bar and a spanner, turn the pulley in a clockwise direction, to relieve the tension from the timing belt. Retighten the tensioner pulley retaining bolt to secure it in the slackened position.

**11** If the timing belt is to be re-used, use white paint or chalk to mark the direction of rotation on the belt (if markings do not already exist), then slip the belt off the sprockets. Note that the crankshaft must not be rotated whilst the belt is removed.

**12** Check the timing belt carefully for any signs of uneven wear, splits or oil contamination. Pay particular attention to the roots of the teeth. Renew it if there is the slightest doubt about its condition. If the engine is undergoing an overhaul, renew the belt as a matter of course, regardless of its apparent condition. The cost of a new belt is nothing compared with the cost of repairs, should the belt break in service. If signs of oil contamination are found, trace the source of the oil leak and rectify it. Wash down the engine timing belt area and all related components, to remove all traces of oil. Check that the tensioner and idler pulleys rotate freely, without any sign of roughness. If necessary, renew them as described in Section 9.



**8.16b** ... high pressure fuel pump sprocket ...

## Refitting

### Two-piece camshaft sprocket

**13** Commence refitting by ensuring that the engine assembly/valve timing holes are still aligned as described in Section 3, and the crankshaft, and camshaft sprocket hub are locked in position.

**14** Tighten the camshaft sprocket retaining bolts lightly so that the sprocket can still move within the elongated slots. Turn the sprocket fully clockwise to the ends of the slots.

**15** Locate the timing belt on the crankshaft sprocket making sure that the direction of rotation arrow is facing the correct way.

**16** Hold the belt on the crankshaft sprocket and, while keeping the 'lower run' of the belt taut (between the crankshaft and idler pulley), feed the belt over the remaining sprockets and pulleys in the following order (see illustrations):

- Idler pulley.
- High-pressure fuel pump.
- Camshaft.
- Coolant pump.
- Tensioner pulley.

**17** Fit the sensor head of the electronic belt tension measuring equipment to the 'top run' of the timing belt, approximately midway between the camshaft and fuel pump sprockets.

**18** Slacken the tensioner pulley retaining bolt and, using the square bar and spanner, pivot the tensioner pulley anti-clockwise until an initial setting of  $98 \pm 2$  SEEM units is displayed on the tension measuring equipment (see illustrations). Hold the



**8.16c** ... camshaft sprocket ...

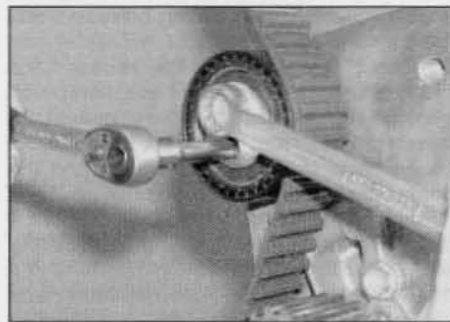

**8.18a** Pivot the tensioner pulley anti-clockwise, then tighten the retaining bolt ...



**8.18b** ... when the specified tension value is shown on the measuring equipment – 2.0 litre engines



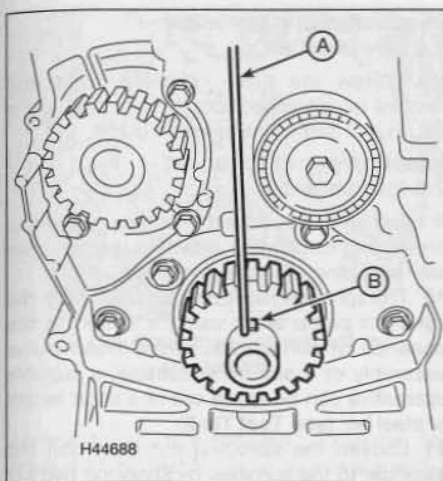

**8.31** Insert a 2 mm rod (A) on the left-hand side of the Woodruff key (B) – 2.0 litre engines

tensioner pulley in that position and retighten the retaining bolt.

**19** Check that the camshaft sprocket retaining bolts are not at the ends of their slots (if necessary, remove one of the sprocket bolts to check this). If they are, repeat the refitting operation. If all is satisfactory, refit the removed bolt and tighten all three sprocket retaining bolts to the specified torque.

**20** Remove the belt tension measuring equipment and the crankshaft, and camshaft sprocket hub locking tools.

**21** Rotate the crankshaft through eight complete rotations in a clockwise direction (viewed from the right-hand end of the engine). Realign the engine assembly/valve timing holes and refit the crankshaft locking tool only.

**22** Slacken the camshaft sprocket retaining bolts and refit the camshaft sprocket hub locking tool.

**23** Slacken the tensioner pulley retaining bolt once more.

**24** Refit the belt tension measuring equipment to the top run of the belt, and turn the tensioner pulley to give a final setting of  $54 \pm 2$  SEEM units on the tensioning gauge. Hold the tensioner pulley in this position and tighten the retaining bolt to the specified torque.

**25** Retighten the camshaft sprocket retaining bolts to the specified torque.

**26** Release the sensor head of the belt tension measuring equipment, then refit it again and check that a reading of  $54 \pm 3$  SEEM units is indicated. Remove the tension measuring equipment.

**27** Remove the locking tools, then rotate the crankshaft once again through two complete rotations in a clockwise direction. Realign the engine assembly/valve timing holes and refit the crankshaft locking tool.

**28** Check that it is possible to insert the camshaft sprocket hub locking tool. If the tool cannot be inserted, check that the offset

between the timing slot in the sprocket hub and the corresponding hole in the cylinder head is not greater than 1.0 mm. If it is, repeat the complete timing belt refitting and tensioning procedure.

**29** Refit the lower, intermediate and upper timing belt covers as described in Section 6. Refit the crankshaft pulley as described in Section 5 after refitting the lower cover.

#### Fixed camshaft sprocket

**30** Ensure that the engine assembly/valve timing holes are still aligned as described in Section 3, and the crankshaft and camshaft sprocket are locked in position.

**31** Turn the crankshaft sprocket anti-clockwise to the limit of the movement afforded by the keyway. Lock the sprocket in this position by inserting a 2.0 mm diameter rod down the left-hand side of the Woodruff key (see illustration).

**32** Locate the timing belt on the camshaft sprocket, making sure that the direction of rotation arrow is facing the correct way.

**33** Retain the timing belt on the camshaft sprocket using a cable tie to ensure that it does not jump a tooth. Keeping the 'top run' of the belt taut (between the camshaft and fuel pump sprockets), feed the belt over the remaining sprockets and pulleys in the following order:

- High-pressure fuel pump.
- Idler pulley.
- Crankshaft.
- Coolant pump.
- Tensioner pulley.

**34** Cut off the cable tie securing the timing belt to the camshaft sprocket and remove the rod from the crankshaft sprocket keyway.

**35** Fit the sensor head of the electronic belt tension measuring equipment to the 'top run' of the timing belt, approximately midway between the camshaft and fuel pump sprockets.

**36** Slacken the tensioner pulley retaining bolt and, using the square bar and spanner, pivot the tensioner pulley anti-clockwise until an initial setting of  $98 \pm 2$  SEEM units is displayed on the tension measuring equipment. Hold the tensioner pulley in that position and retighten the retaining bolt.

**37** If not already in place, refit the crankshaft pulley retaining bolt and washer and tighten the bolt to 70 Nm (52 lbf ft). Prevent the crankshaft from turning using the flywheel ring gear locking tool described for pulley removal in Section 5. Do not attempt to use only the engine assembly/valve timing locking tools to prevent rotation whilst the bolt is tightened.

**38** Remove the belt tension measuring equipment, the flywheel ring gear locking tool and the engine assembly/valve timing locking tools.

**39** Rotate the crankshaft through eight complete rotations in a clockwise direction (viewed from the right-hand end of the engine). Realign the engine assembly/valve timing holes and refit the crankshaft and camshaft sprocket locking tools.

**40** Refit the flywheel ring gear locking tool and slacken the crankshaft pulley retaining bolt.

**41** Slacken the tensioner pulley retaining bolt once more. Refit the belt tension measuring equipment to the top run of the belt, and turn the tensioner pulley to give a final setting of  $54 \pm 2$  SEEM units on the tensioning gauge. Hold the tensioner pulley in this position and tighten the retaining bolt to the specified torque.

**42** Release the sensor head of the belt tension measuring equipment, then refit it again and check that a reading of  $54 \pm 3$  SEEM units is indicated. If not, repeat the complete tensioning procedure. If the reading is correct, remove the tension measuring equipment.

**43** Remove all the locking tools, then rotate the crankshaft once again through two complete rotations in a clockwise direction. Realign the engine assembly/valve timing holes and refit the crankshaft and camshaft sprocket locking tools. If it is not possible to fit both locking tools, repeat the complete tensioning procedure.

**44** If all is satisfactory, locate the lower timing belt cover in position, refit the retaining bolts and tighten them securely.

**45** With the engine assembly/valve timing holes aligned and the crankshaft and camshaft sprocket locking tools in place, refit the flywheel ring gear locking tool and unscrew the crankshaft pulley retaining bolt.

**46** Locate the crankshaft pulley in position on the end of the crankshaft.

**47** Thoroughly clean the threads of the pulley retaining bolt, then apply a coat of locking compound to the bolt threads (Peugeot/Citroën recommend the use of Loctite Frenetanch).

**48** Refit the crankshaft pulley retaining bolt and washer. Tighten the bolt to the specified torque, then through the specified angle.

**49** Remove the flywheel ring gear locking tool and the crankshaft and camshaft sprocket locking tools.

**50** Refit the intermediate and upper timing belt covers as described in Section 6, then refit and tension the auxiliary drivebelt as described in Chapter 1B.

## 9 Timing belt sprockets and idler/tensioner pulleys – removal, inspection and refitting



### Removal

**1** Disconnect the battery negative terminal (refer to *Disconnecting the battery* in the Reference Chapter).

**2** Position the engine assembly/valve timing holes as described in Section 3, and lock the sprocket hub(s) and flywheel in position.

**Caution:** Do not attempt to rotate the engine whilst the pins are in position.



**TOOL TIP**  
**1**

A sprocket holding tool can be made from two lengths of steel strip bolted together to form a forked end. Bend the end of the strip through 90° to form the fork 'prongs'.

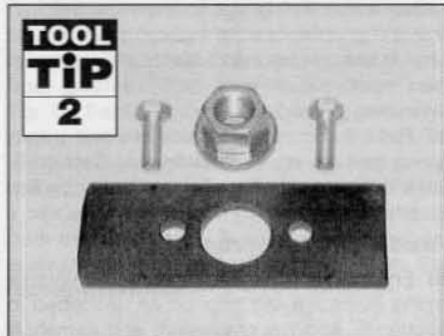

**TOOL TIP**  
**2**

Make a sprocket releasing tool from a short strip of steel. Drill two holes in the strip to correspond with the two holes in the sprocket. Drill a third hole just large enough to accept the flats of the sprocket retaining nut.

**Injection pump sprocket – 1.9 litre engines**

8 Unscrew the three retaining bolts and remove the sprocket from its hub; The hub is an integral part of the injection pump.

**Injection pump sprocket – 2.0 litre engines**

9 Slacken the sprocket retaining nut whilst preventing rotation by retaining the sprocket with a holding tool (see paragraph 5).

10 The sprocket must then be freed from the injection pump shaft using a puller. In the absence of correct Peugeot/Citroën puller assembly or a pattern substitute, a suitable alternative can be made out of a short length of steel bar (see Tool Tip 2).

11 Loosen the sprocket nut then bolt the steel bar to the sprocket by screwing two M7 bolts in the threaded holes provided. Evenly tighten the bolts, so the bar is forced into contact with nut, then unscrew the sprocket nut to draw the sprocket off the pump shaft. Once the sprocket has been released, unscrew the bolts and remove the bar then unscrew the nut and remove the sprocket (see illustrations).

**Crankshaft sprocket – 1.9 litre engines**

12 As a precaution, remove the flywheel locking pin then rotate the crankshaft backwards (anti-clockwise) through 90°; this will position the pistons midway up the bores and remove the risk of the valves contacting the pistons during the following operation.

13 Slacken the crankshaft sprocket bolt. To prevent crankshaft rotation, select top gear, and have an assistant apply the brakes firmly. Alternatively, the flywheel ring gear can be locked using a suitable tool made from steel angle (see Tool Tip in Section 5).

14 Unscrew the retaining bolt and washer, then slide the sprocket off the end of the crankshaft. If the Woodruff key is a loose fit in the crankshaft, remove it and store it with the

3 Remove the timing belt as described in Section 7 or 8, as applicable, then proceed as described under the relevant sub-heading.

**Camshaft sprocket**

4 As a precaution, remove the flywheel locking pin then rotate the crankshaft backwards (anti-clockwise) through 90°; this

will position the pistons midway up the bores and remove the risk of the valves contacting the pistons during the following operation.

5 Slacken the sprocket hub retaining bolt, and the three sprocket-to-hub retaining bolts (where applicable). To prevent the camshaft rotating as the bolt is slackened, a sprocket-holding tool will be required. In the absence of the special Peugeot/Citroën tool, an acceptable substitute can be fabricated at home (see Tool Tip 1). Do not attempt to use the engine assembly/valve timing locking tool to prevent the sprocket from rotating whilst the bolt is slackened.

6 Unscrew the sprocket hub retaining bolt and slide the sprocket and hub off the end of the camshaft. If the Woodruff key is a loose fit, remove it for safe-keeping. Examine the camshaft oil seal for signs of oil leakage and, if necessary, renew it as described in Section 10.

7 If necessary on engines with a two-piece sprocket, the sprocket can be separated from the hub after removing the three retaining bolts.

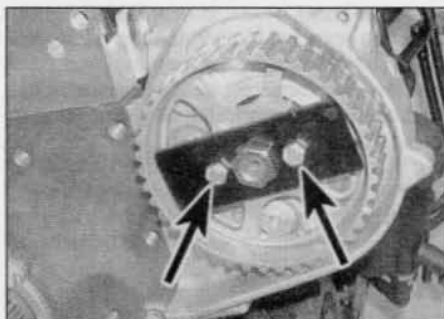

9.11a Fit the bar over the sprocket nut and screw in the two bolts (arrowed) – 2.0 litre engines

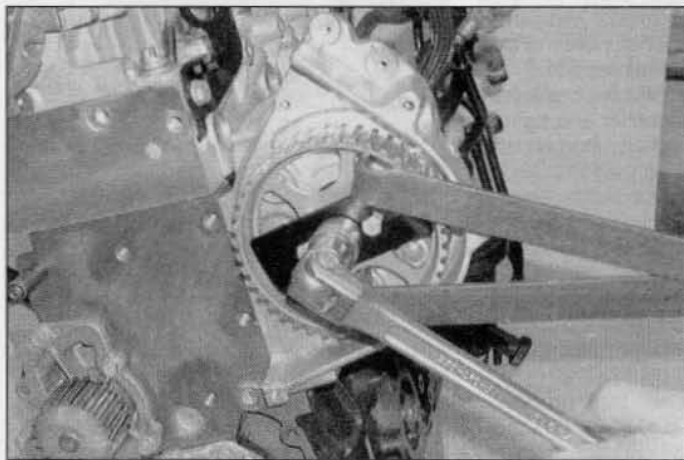

9.11b With the puller in position, retain the sprocket then unscrew the sprocket nut to release the sprocket from the pump shaft – 2.0 litre engines

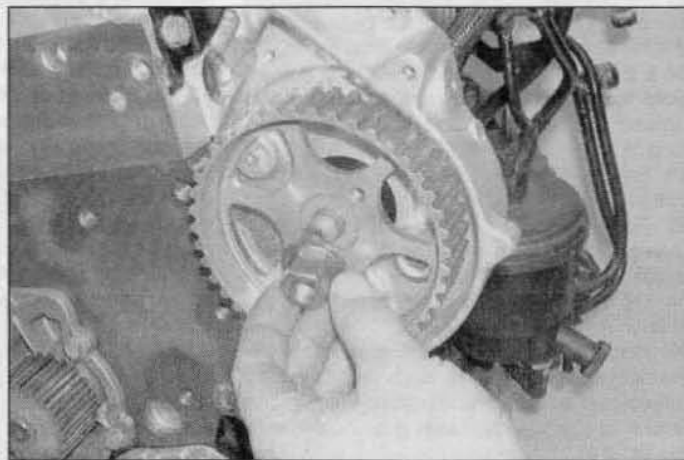

9.11c Once the sprocket is free, remove the puller then unscrew the nut and lift off the sprocket – 2.0 litre engines



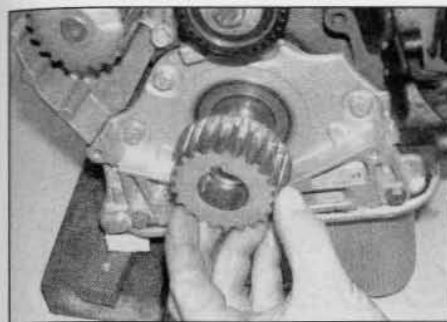

9.15a Slide the sprocket off the crankshaft ...

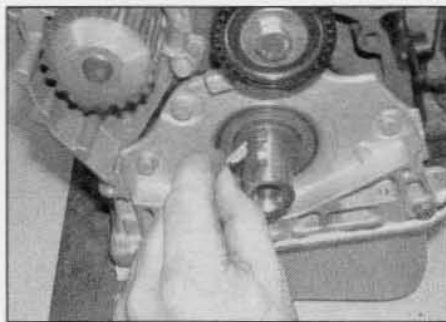

9.15b ... then remove the Woodruff key – 2.0 litre engines

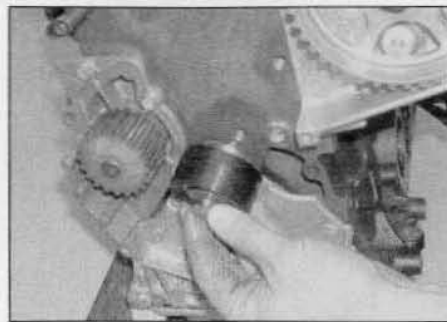

9.18 Unscrew the mounting bolt and remove the idler pulley from the block

sprocket for safe-keeping. Examine the crankshaft oil seal for signs of oil leakage and, if necessary, renew as described in Section 17.

#### Crankshaft sprocket – 2.0 litre engines

15 Slide the sprocket and off the end of the crankshaft. If the Woodruff key is a loose fit in the crankshaft, remove it and store it with the sprocket for safe-keeping (see illustrations). Examine the crankshaft oil seal for signs of oil leakage and, if necessary, renew as described in Section 17.

#### Coolant pump sprocket

16 The coolant pump sprocket is integral with the pump, and cannot be removed. Coolant pump removal is described in Chapter 3.

#### Tensioner pulley

17 Unscrew the bolt and remove the pulley from its mounting pin. Examine the mounting stud for signs of damage and, if necessary, renew it.

#### Idler pulley

18 Unscrew the mounting bolt and remove the idler pulley from the cylinder block (see illustration).

#### Inspection

19 Clean the sprockets thoroughly, and renew any that show signs of wear, damage or cracks.

20 Clean the tensioner and idler pulleys, but do not use any strong solvent which may enter the pulley bearing. Check that each pulley rotates freely about its hub, with no sign of stiffness or of free play. Renew the pulley if there is any doubt about its condition, or if there are any obvious signs of wear or damage.

21 Inspect the timing belt (see Sections 7 or 8). Renew the belt if there is any doubt about its condition.

#### Refitting

##### Camshaft sprocket

22 On engines with a two-piece sprocket, refit the sprocket to the hub (if removed) and

secure with the three retaining bolts, tightened finger tight only at this stage.

23 Refit the Woodruff key to the end of the camshaft, then refit the camshaft sprocket and hub.

24 Refit the sprocket hub retaining bolt and washer. Tighten the bolt to the specified torque, preventing the camshaft from turning as during removal.

25 Align the hub timing hole with the cylinder head and insert the locking tool. Rotate the crankshaft 90° clockwise and lock the flywheel in position with the locking tool.

26 Refit the timing belt (see Section 7 or 8).

##### Injection pump sprocket – 1.9 litre engines

27 Seat the sprocket on the hub and lightly tighten its bolts.

28 Refit the timing belt (see Section 7).

##### Injection pump sprocket – 2.0 litre engines

29 Ensure the pump shaft and sprocket taper surfaces are clean and dry then fit the sprocket to the pump. Refit the sprocket nut and tighten it to the specified torque, using the holding tool to prevent rotation.

30 Refit the timing belt (see Section 8).

##### Crankshaft sprocket – 1.9 litre engines

31 Where removed, locate the Woodruff key in the crankshaft end.

32 Align the crankshaft pulley slot with the Woodruff key, and slide it onto the end of the crankshaft.

33 Remove all traces of locking compound from the threads of the pulley bolt and crankshaft. Apply a drop of locking compound (Peugeot/Citroën recommend the use of Loctite Frenetanch) to the threads of the bolt then refit the bolt and washer to the crankshaft.

34 Tighten the bolt to the specified torque Stage 1 torque setting, whilst preventing crankshaft rotation using the method employed on removal.

35 Angle-tighten the pulley bolt through the specified Stage 2 angle, using a socket and extension bar. It is recommended that an angle-measuring gauge is used during this

stage of the tightening, to ensure accuracy.

36 Rotate the crankshaft 90° clockwise and lock the flywheel in position with the locking tool.

37 Refit the timing belt (see Section 7).

##### Crankshaft sprocket – 2.0 litre engines

38 Where removed, locate the Woodruff key in the crankshaft end.

39 Align the crankshaft pulley slot with the Woodruff key, and slide it onto the end of the crankshaft.

40 Refit the timing belt (see Section 8).

##### Tensioner pulley

41 Refit the tensioner pulley to its mounting pin, and fit the retaining bolt.

42 Refit the timing belt (see Section 7 or 8).

##### Idler pulley

43 Refit the idler pulley to the cylinder block and tighten its retaining bolt to the specified torque.

44 Refit the timing belt (see Section 7 or 8).

#### 10 Camshaft oil seal – renewal

**Note:** If the camshaft oil seal has been leaking, check the timing belt for signs of oil contamination; the belt must be renewed if signs of oil contamination are found. Ensure that all traces of oil are removed from the sprockets and surrounding area before the new belt is fitted.

1 Remove the camshaft sprocket as described in Section 9.

2 Punch or drill two small holes opposite each other in the oil seal. Screw a self-tapping screw into each, and pull on the screws with pliers to extract the seal.

3 Clean the seal housing, and polish off any burrs or raised edges, which may have caused the seal to fail in the first place.

4 Lubricate the lips of the new seal with clean engine oil, and drive/press it into position until it seats on its locating shoulder. Use a suitable tubular drift, such as a socket, which bears only on the hard outer edge of the seal



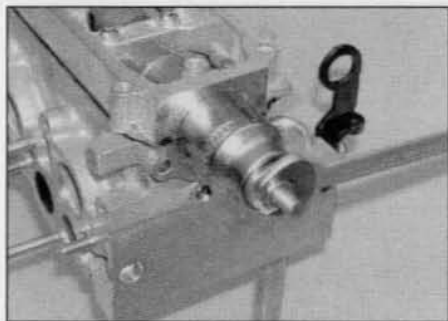

**10.4** Using a socket, a length of stud and a nut to press the camshaft oil seal into position

(see illustration). Take care not to damage the seal lips during fitting. Note that the seal lips should face inwards.

**5** Refit the camshaft sprocket as described in Section 9.

### 11 Camshaft and followers – removal, inspection and refitting



**Note:** On 1.9 litre engines, valve clearance adjustment requires the removal of the camshaft. If the original camshaft is being refitted, it is worthwhile recording the valve clearances before it is removed, so any adjustments can be made before refitting it (see Section 12).

#### Removal

**1** Remove the cylinder head cover as described in Section 4.

**2** Remove the braking system vacuum pump as described in Chapter 9.

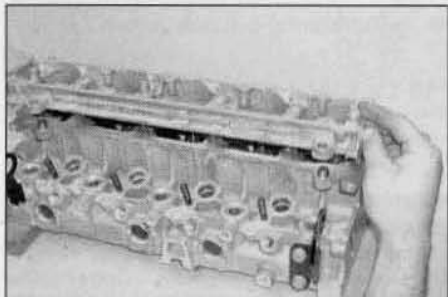

**11.10** Remove the bearing cap casting ...

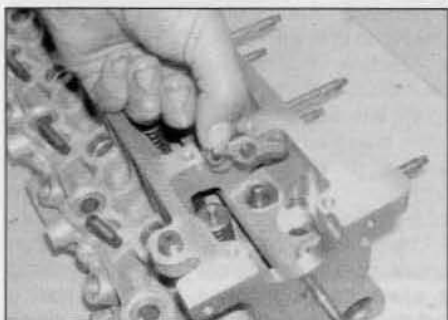

**11.12a** Lift the camshaft followers ...

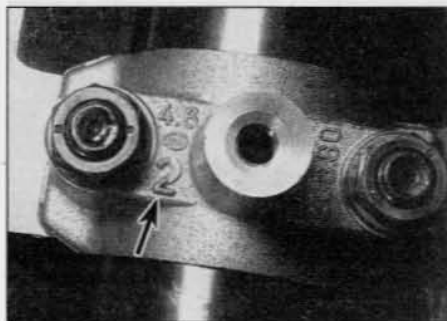

**11.4** The camshaft bearing caps should be numbered (arrowed) for identification – 1.9 litre engines

**3** Remove the camshaft sprocket as described in Section 9. Proceed as described under the relevant sub-heading.

#### 1.9 litre engines

**4** The camshaft bearing caps should be numbered 1 to 3, number 1 being at the transmission end of the engine (see illustration). If not, make identification marks on the caps, using white paint or a suitable marker pen. Also mark each cap in some way to indicate its correct fitted orientation. This will avoid the possibility of installing the caps the wrong way around on refitting.

**5** Evenly and progressively slacken the camshaft bearing cap retaining nuts by one turn at a time. This will relieve the valve spring pressure on the bearing caps gradually and evenly. Once the pressure has been relieved, the nuts can be fully unscrewed and removed.

**Caution:** If the bearing cap nuts are carelessly slackened, the bearing caps may break. If any bearing cap breaks then the

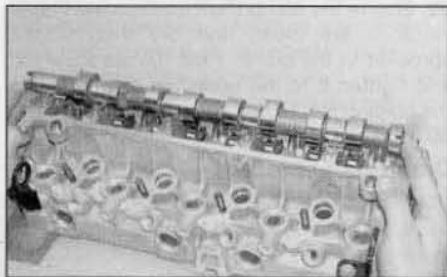

**11.11** ... then lift the camshaft out of position (shown with cylinder head removed) – 2.0 litre engines



**11.12b** ... and hydraulic tappets out from the cylinder head – 2.0 litre engines

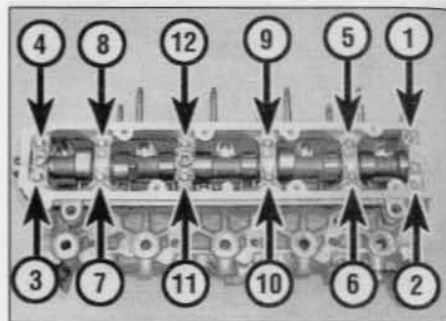

**11.9** Camshaft bearing cap casting bolt slackening sequence – 2.0 litre engines

**complete cylinder head assembly must be renewed; the bearing caps are matched to the head and are not available separately.**

**6** Note the correct fitted orientation of the bearing caps, then remove them from the cylinder head.

**7** Lift the camshaft away from the cylinder head, and slide the oil seal off the camshaft end.

**8** Obtain eight small, clean plastic containers, and number them 1 to 8; alternatively, divide a larger container into eight compartments. Using a rubber sucker, withdraw each follower in turn, and place it in its respective container. Do not interchange the cam followers, or the rate of wear will be much-increased. If necessary, also remove the shim from the top of the valve stem, and store it with its respective follower. **Note:** The shim may stick to the inside of the follower as it is withdrawn. If this happens, take care not to allow it to drop out as the follower is removed.

#### 2.0 litre engines

**9** Working in sequence, evenly and progressively slacken the camshaft bearing cap casting retaining bolts by one turn at a time (see illustration). This will relieve the valve spring pressure on the bearing caps gradually and evenly. Once the pressure has been relieved, the bolts can be fully unscrewed and removed.

**Caution:** If the bearing cap casting bolt are carelessly slackened, the casting may break. If the casting breaks then the complete cylinder head assembly must be renewed; the casting is matched to the head and is not available separately.

**10** Remove the camshaft bearing cap casting from the cylinder head (see illustration). If the casting locating dowels are a loose fit in the head, remove them and store them with the casting for safe-keeping.

**11** Lift the camshaft away from the cylinder head, and slide the oil seal off the camshaft end (see illustration).

**12** Obtain eight, oil tight, clean plastic containers, and number them 1 to 8. Each container must be deep enough to allow the tappets to be almost totally submerged in oil. Lift each follower and hydraulic tappet out of position and place it in its respective container (see illustrations). Add clean engine oil to each container so that the tappet is

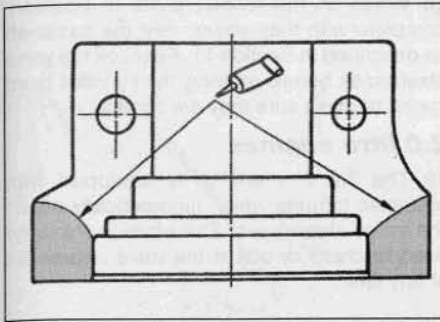

11.22 Apply sealant to the areas shown on the camshaft end bearing caps – 1.9 litre engines

submerged. Do not interchange the cam followers or tappets, or the rate of wear will be much-increased.

### Inspection

13 Examine the camshaft bearing surfaces and cam lobes for signs of wear ridges and scoring. Renew the camshaft if any of these conditions are apparent. Examine the condition of the bearing surfaces, both on the camshaft journals and in the cylinder head/bearing caps. If the head bearing surfaces are worn excessively, the cylinder head will need to be renewed.

14 Examine the cam follower bearing surfaces which contact the camshaft lobes for wear ridges and scoring. Renew any follower on which these conditions are apparent. If a follower bearing surface is badly scored, also examine the corresponding lobe on the camshaft for wear, as it is likely that both will be worn. Renew worn components as necessary.

15 On 2.0 litre engines, if the hydraulic tappets are thought to be faulty they should be renewed.

### Refitting

#### 1.9 litre engines

16 If the original camshaft is being refitted, and it is known that the valve clearances are correct, proceed to the next paragraph, otherwise, adjust the valves as described in Section 12 using the clearances noted before camshaft removal. If a new camshaft is used, fit it as described in paragraphs 17 to 23, and then adjust the valve clearances (Section 12).

**Caution: Ensure the crankshaft is correctly positioned with the pistons midway up the bores before rotating the camshaft.**

17 Fit each shim to the top of its valve stem.

**Caution: Do not interchange the shims, as this will upset the valve clearances (see Section 12).**

18 Liberally oil the cylinder head cam follower bores and the followers. Carefully refit the followers to the cylinder head, ensuring that each follower is refitted to its original bore. Some care will be required to enter the followers squarely into their bores.

19 Lubricate the cam lobes and bearing

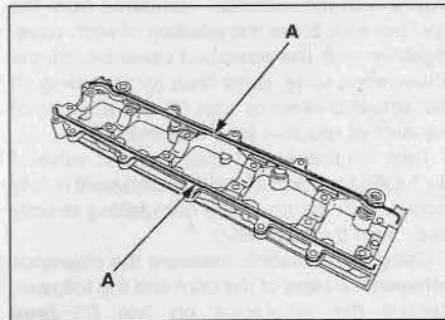

11.31 Apply a thin bead of sealant (A) to the mating surface of the camshaft bearing cap casting as shown – 2.0 litre engines

journals with clean engine oil of the specified grade. Then refit the camshaft back into position on the cylinder head.

20 Temporarily refit the sprocket to the end of the camshaft and position it so that the hub timing hole is aligned with the corresponding cut-out in the cylinder head. Ensure the crankshaft is still positioned 90° BTDC so the pistons are midway up the bores.

21 Fit the centre bearing cap the correct way round as previously noted, then screw on the nuts and tighten them two or three turns.

22 Apply sealing compound to the end bearing caps on the areas shown (see illustration). Fit them in the correct positions, and tighten the nuts two or three turns.

23 Tighten all the nuts evenly and progressively to the specified torque, making sure that the camshaft remains correctly positioned.

**Caution: If the bearing cap nuts are carelessly tightened, the bearing caps may break. If any bearing cap breaks then the complete cylinder head assembly must be renewed; the bearing caps are matched to the head and are not available separately.**

24 Smear the lips of the new oil seal with clean engine oil and fit it onto the camshaft end, making sure its sealing lip is facing inwards. Press the oil seal in until it is flush with the end face of the camshaft bearing cap.

25 Refit the camshaft sprocket as described in Section 9.

26 Refit the braking system vacuum pump as described in Chapter 9.

27 Refit the cylinder head cover as described in Section 4.

#### 2.0 litre engines

28 Liberally oil the cylinder head tappet bores and the followers. Ensure the followers and hydraulic tappets are correctly clipped together then carefully refit them to the cylinder head, ensuring that each assembly is refitted in its original location.

29 Lubricate the cam bearing journals and followers with clean engine oil of the specified grade.

30 Ensure the crankshaft is still positioned 90° BTDC so the pistons are midway up the bores.

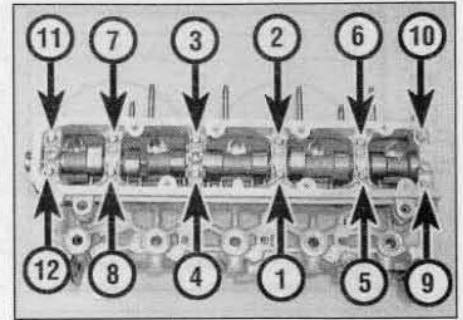

11.33 Camshaft bearing cap bolt tightening sequence – 2.0 litre engines

31 Ensure the mating surfaces of the camshaft bearing cap casting and cylinder head are clean and dry. Apply a thin bead of sealant (Peugeot/Citroën recommend the use of Autojoint NOIR) to the mating surface of the casting as shown (see illustration).

32 Locate the camshaft correctly in the bearing cap casting then, ensuring the locating dowels are in position, refit the camshaft and bearing cap casting assembly to the head.

33 Install the bearing cap casting bolts, tightening all bolts by hand. Working in sequence, evenly and progressively tighten the bolts to draw the casting squarely down onto the cylinder head (see illustration). Once the casting is in contact with the head, go around in the specified sequence and tighten the bolts to the specified torque.

**Caution: If the bearing cap casting bolts are carelessly tightened, the casting may break. If the casting breaks then the complete cylinder head assembly must be renewed; the casting is matched to the head and is not available separately.**

34 Smear the lips of the new oil seal with clean engine oil and fit it onto the camshaft end, making sure its sealing lip is facing inwards. Press the oil seal in until it is flush with the end face of the camshaft bearing cap.

35 Refit the camshaft sprocket and hub as described in Section 9.

36 Refit the braking system vacuum pump as described in Chapter 9.

37 Refit the cylinder head cover as described in Section 4.

## 12 Valve clearances – checking and adjustment



### 1.9 litre engines

#### Checking

1 The importance of having the valve clearances correctly adjusted cannot be overstressed, as they vitally affect the performance of the engine. Checking should not be regarded as a routine operation,



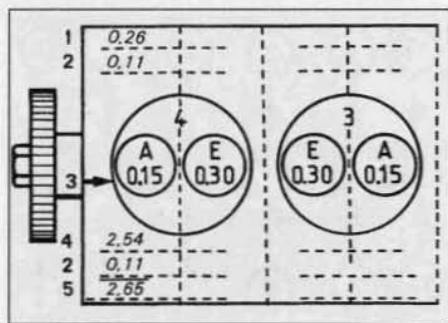

12.5 Example of valve shim thickness calculation - 1.9 litre engines

- A Inlet valve
- B Exhaust valve
- 1 Measured clearance
- 2 Difference from specified clearance (3)
- 3 Specified clearance
- 4 Thickness of shim fitted
- 5 Correct thickness of shim required

however. It should only be necessary when the valve gear has become noisy, after engine overhaul, or when trying to trace the cause of power loss. The clearances are checked as follows. The engine must be cold for the check to be accurate.

2 Firmly apply the handbrake, then jack up the front of the car and support it securely on axle stands (see *Jacking and vehicle support*). To gain access to the right-hand end of the engine, the wheel arch plastic liner must be removed. The liner is secured by various screws and clips under the wheel arch. Release all the fasteners, and remove liner from under the front wing. Where necessary, unclip the coolant hoses from under the wing to improve access further.

3 The engine can now be turned over using a suitable socket and extension bar fitted to the crankshaft pulley bolt. Note that the crankshaft must always be turned in a clockwise direction (viewed from the right-hand side of the vehicle).

4 Remove the cylinder head cover as described in Section 4.

5 On a piece of paper, draw the outline of the

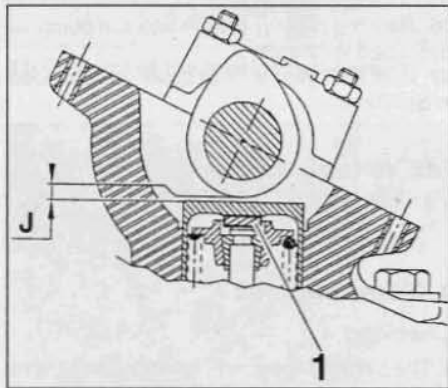

12.7 Valve clearance measurement (J). Clearance is altered by changing the shim (1) - 1.9 litre engines

engine with the cylinders numbered from the flywheel end. Show the position of each valve, together with the specified valve clearance. Above each valve, draw lines for recording (1) the actual clearance and (2) the amount of adjustment required (see illustration).

6 Turn the crankshaft until the inlet valve of No 1 cylinder (nearest the transmission) is fully closed, with the tip of the cam facing directly away from the follower.

7 Using feeler blades, measure the clearance between the base of the cam and the follower. Record the clearance on line (1) (see illustration).

8 Repeat the measurement for the other seven valves, turning the crankshaft as necessary so that the cam lobe in question is always facing directly away from the relevant follower.

9 Calculate the difference between each measured clearance and the desired value, and record it on line (2). Since the clearance is different for inlet and exhaust valves - make sure that you are aware which valve you are dealing with. The valve sequence from either end of the engine is:

*In - Ex - Ex - In - In - Ex - Ex - In*

10 If all the clearances are within tolerance, refit the cylinder head cover with reference to Section 4. Refit the wheel arch liner then lower the vehicle to the ground. If any clearance measured is outside the specified tolerance, adjustment must be carried out as described in the following paragraphs.

#### Adjustment

11 Remove the camshaft as described in Section 11.

12 Withdraw the first follower and its shim. Clean the shim, and measure its thickness with a micrometer. The shims carry thickness markings, but wear may have reduced the original thickness, so be sure to check.

13 Refer to the clearance recorded for the valve concerned. If the clearance was more than that specified, the shim thickness must be increased by the difference recorded (2). If the clearance was less than that specified, the thickness of the shim must be decreased by the difference recorded (2).

14 Draw three more lines beneath each valve on the calculation paper as shown in illustration 12.5. On line (4) note the measured thickness of the shim, then add or deduct the difference from line (2) to give the final shim thickness required on line (5).

15 Repeat the procedure given in paragraphs 13 to 15 on the remaining valves, keeping each follower identified for position.

16 Obtain the shims required to bring each valve clearance within tolerance. Note that the shims can be swapped around, but not the followers.

17 When reassembling, oil the shim and fit it into the valve retainer, with the size marking face downwards. Oil the follower, and lower it onto the shim. Do not raise the follower after fitting, as the shim may become dislodged.

18 When all the followers are in position, complete with their shims, refit the camshaft as described in Section 11. Recheck the valve clearances before refitting the cylinder head cover, to make sure they are correct.

#### 2.0 litre engines

19 The 2.0 litre engine is equipped with hydraulic tappets which automatically adjust the valve clearances. Therefore there is no need to check or adjust the valve clearances at any time.

#### 13 Cylinder head (1.9 litre engines) - removal and refitting

**Note 1:** This is an involved procedure, and it is suggested that the Section is read thoroughly before starting work. To aid refitting, make notes on the locations of all relevant brackets and the routing of hoses and cables before removal.

**Note 2:** On 2.0 litre engines, due to the limited access, it is impossible to remove the cylinder head with the engine in the car unless considerable additional dismantling is carried out first (eg, removal of the front suspension subframe and related components). Cylinder head removal and refitting procedures are therefore contained in Part E, assuming that the engine/transmission has been removed from the vehicle.

#### Removal

1 Disconnect the battery negative terminal (refer to *Disconnecting the battery* in the Reference Chapter).

2 Drain the cooling system as described in Chapter 1B.

3 Remove the braking system vacuum pump as described in Chapter 9.

4 Remove the timing belt as described in Section 7.

5 Once the timing belt has been removed, unscrew the single bolt securing the right-hand engine/transmission mounting bracket to the cylinder head. Leave all the bolts securing the bracket to the cylinder block then refit the upper bracket, securing the engine bracket to the mounting, and securely tighten its nuts and bolts. This will ensure the engine/transmission unit is securely supported through out the following procedure.

6 If the cylinder head is to be overhauled, remove the camshaft sprocket and camshaft (see Sections 9 and 11).

7 Referring to Chapter 4C, carry out the following operations.

- a) Remove the air cleaner housing.
- b) Remove the inlet and exhaust manifolds.
- c) Disconnect and remove the fuel return hose from the end injector.
- d) Unscrew the union nuts and disconnect the fuel pipes from the fuel injectors and the fuel injection pump. Remove the pipes.
- e) If the cylinder head is being overhauled, remove the injectors.



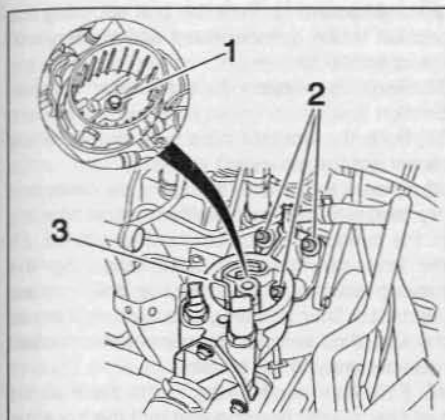

**13.10** Unscrew the bolt (1) and remove the fuel filter housing then undo the three bolts (2) and free the filter/thermostat housing (3) from the cylinder head – 1.9 litre engines

8 Remove the cylinder head cover as described in Section 4.

9 Remove the fuel filter as described in Chapter 1B.

10 Unscrew the retaining bolt and remove the filter plastic housing, complete with its sealing ring (see illustration). Discard the sealing ring; a new one must be used on refitting.

11 Slacken and remove the three bolts, noting the correct fitted location of the sealing washer, securing the fuel filter/thermostat housing to the front of the cylinder head. Disconnect the coolant hose connecting the housing to the coolant pipe then free the housing from the cylinder head. Recover the housing gasket and discard it; a new one must be used on refitting.

12 Unscrew the securing nut and disconnect the feed wire from the relevant glow plug. Recover the washers.

13 Unscrew the bolt securing the coolant pipe to the left-hand end of the cylinder head.

14 Check that the wiring and hoses is released from all the relevant clips or guides on the cylinder head and positioned clear.

15 Working in the reverse of the sequence shown in illustration 13.32, progressively slacken the ten cylinder head bolts by half a turn at a time, until all bolts can be unscrewed by hand.

16 With all the cylinder head bolts removed, release the cylinder head from the cylinder block and locating dowel by rocking it. The Peugeot/Citroën tool for doing this consists simply of two metal rods with 90-degree angled ends. Do not prise between the mating faces of the cylinder head and block, as this may damage the gasket faces. Lift the cylinder head away; seek assistance if possible.

17 Remove the gasket from the top of the block, noting the locating dowel. If the locating dowel is a loose fit, remove it and store it with the head for safe-keeping. Do not discard the gasket – it will be needed for identification purposes (see paragraphs 22 to 25).

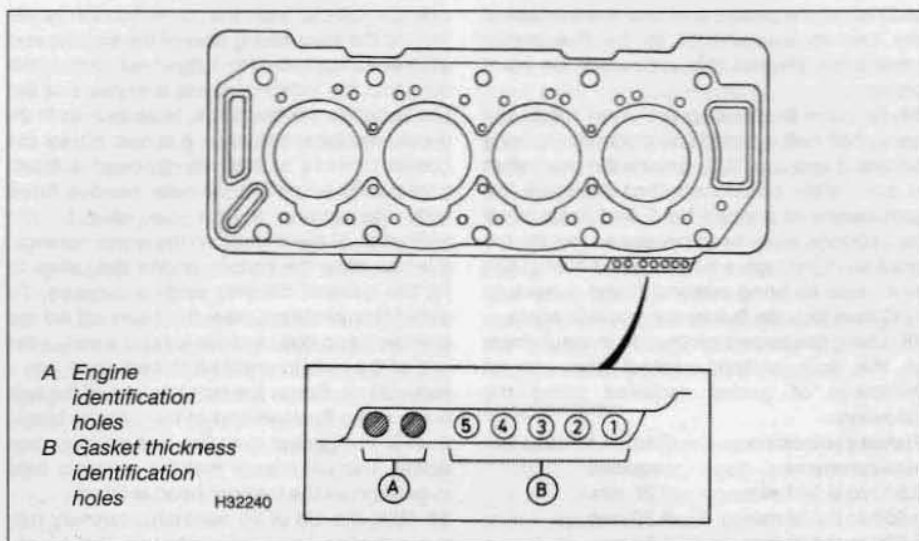

**13.22** Cylinder head gasket identification holes – 1.9 litre engines

18 If the cylinder head is to be dismantled for overhaul, remove the camshaft and followers as described in Section 11, then refer to Part E of this Chapter.

### Preparation for refitting

19 The mating faces of the cylinder head and cylinder block must be perfectly clean before refitting the head. Use a hard plastic or wood scraper to remove all traces of gasket and carbon; also clean the piston crowns. Take particular care during the cleaning operations, as aluminium alloy is easily damaged. Also, make sure that the carbon is not allowed to enter the oil and water passages – this is particularly important for the lubrication system, as carbon could block the oil supply to the engine's components. Using adhesive tape and paper, seal the water, oil and bolt holes in the cylinder block/crankcase. To prevent carbon entering the gap between the pistons and bores, smear a little grease in the gap. After cleaning each piston, use a small brush to remove all traces of grease and carbon from the gap, then wipe away the remainder with a clean rag. Clean all the pistons in the same way.

20 Check the mating surfaces of the cylinder block and the cylinder head for nicks, deep scratches and other damage. If slight, they may be removed carefully with a file, but if excessive, machining may be the only alternative to renewal.

21 If warpage of the cylinder head gasket surface is suspected, use a straight-edge to check it for distortion. Refer to Part E of this Chapter if necessary.

22 When purchasing a new cylinder head gasket, it is essential that a gasket of the correct thickness is obtained. There are six different thicknesses of gasket available to enable the cylinder head-to-piston clearance to be accurately set. The gasket thickness can be determined by looking at the tab situated

in front of No 1 cylinder (see illustration). There will be between 3 and 7 holes in the tab; the first two holes (in location A) identify the engine type (DW8), these are present on all gaskets and are of no real significance. It is the last group of between 1 and 5 holes (in location B) which identify the gasket thickness as follows.

Number of holes (hole locations)	Gasket thickness (when compressed)
1 (1)	1.26 mm
2 (1 and 2)	1.30 mm
3 (1, 2 and 3)	1.34 mm
4 (1, 2, 3 and 4)	1.38 mm
5 (1, 2, 3, 4 and 5)	1.42 mm
2 (1 and 5)	1.46 mm

The correct thickness of gasket required is selected by measuring the piston protrusions as follows.

23 Ensure the flywheel is correctly locked in position so pistons 1 and 4 are exactly at TDC. Mount a dial test indicator securely on the block so that its pointer can be easily pivoted between the piston crown and block mating surfaces. Zero the dial test indicator on the gasket surface of the cylinder block then carefully move the indicator over No 1 piston and measure its protrusion (see illustration). Take measurements at the front

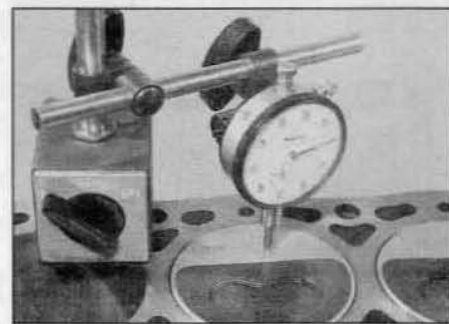

**13.23** Measuring piston protrusion – 1.9 litre engines

and rear of the piston, and take the average of the two measurements to be the piston protrusion. Repeat this procedure on No 4 piston.

**24** Remove the locking tool then rotate the crankshaft half-a-turn (180°) clockwise to bring pistons 2 and 3 to TDC. Ensure the crankshaft is accurately positioned then measure the protrusions of pistons No 2 and 3. Once all four pistons have been measured, rotate the crankshaft through a further half-a-turn (180°) clockwise to bring pistons 1 and 4 back to TDC then lock the flywheel in position again.

**25** Using the largest protrusion measurement of the four pistons, select the correct thickness of gasket required using the following:

Piston protrusion measurement	Gasket thickness required
0.510 to 0.549 mm	1.26 mm
0.550 to 0.589 mm	1.30 mm
0.590 to 0.629 mm	1.34 mm
0.630 to 0.669 mm	1.38 mm
0.670 to 0.709 mm	1.42 mm
0.710 to 0.750 mm	1.46 mm

**26** Carefully examine the cylinder head bolts for signs of damage to the threads or head, and for any sign of corrosion. If the bolts are in a satisfactory condition, measure the length of each bolt from the underside of the head, to the end of the unthreaded portion at the base of the shank (**see illustration**). The bolts may be re-used providing that the measured length does not exceed 125.5 mm. Note that, if a bolt is modified to locate the gasket (see paragraph 28), a new bolt will be required when finally refitting the cylinder head. **Note:** *Considering the stress to which the cylinder head bolts are subjected, it is highly recommended that they are all renewed, regardless of their apparent condition.*

### Refitting

**27** Turn the crankshaft clockwise (viewed from the timing belt end) until Nos 1 and 4 pistons pass bottom dead centre (BDC) and begin to rise, then position them halfway up their bores. Nos 2 and 3 pistons will also be at their midway positions, but descending their bores.

**28** Wipe clean the mating surfaces of the cylinder head and cylinder block. Fit the correct gasket the right way round on the

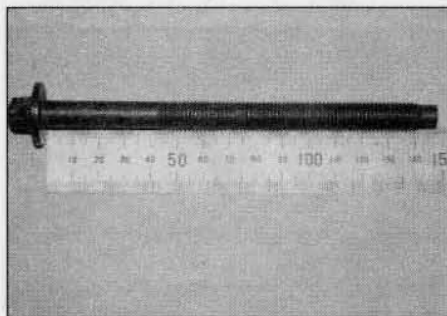

**13.26** Measure the length of each bolt from the underside of the head, to the base of the shank – 1.9 litre engines

cylinder block, with the identification holes toward the front facing side of the engine, and adjacent to cylinder No 1 (flywheel end). Make sure that the locating dowel is in place at the timing belt end of the block. Note that, as there is only one locating dowel, it is possible for the gasket to move as the cylinder head is fitted, particularly when the cylinder head is fitted with the engine in the car (due to the inclination of the engine). In the worst instance, this can allow the pistons and/or the valves to hit the gasket, causing engine damage. To avoid this problem, saw the head off an old cylinder head bolt, and file (or cut) a slot in the end of the bolt, to enable it to be turned with a screwdriver. Screw the bolt into one of the bolt holes at the flywheel end of the cylinder block, then fit the gasket over the bolt and location dowel. This will ensure that the gasket is held in position as the cylinder head is fitted.

**29** With the aid of an assistant, carefully refit the cylinder head assembly to the block, aligning it with the locating dowel.

**30** Lubricate the threads and underside of the heads of the cylinder head bolts with a smear of grease (Peugeot/Citroën recommend the use of Molykote G Rapid Plus grease).

**31** Carefully enter each bolt into its relevant hole (*do not drop them in*) and screw in, by hand only, until finger-tight.

**32** Working progressively and in sequence, tighten the cylinder head bolts to their Stage 1 torque setting, using a torque wrench and suitable socket (**see illustration**).

**33** Once all the bolts have been tightened to their Stage 1 setting, working again in the given sequence, tighten the cylinder head bolts to the specified Stage 2 torque setting.

**34** Finally angle-tighten the bolts through the specified Stage 3 angle, using a socket and extension bar. It is recommended that an angle-measuring gauge is used during this stage of the tightening, to ensure accuracy. If a gauge is not available, use white paint to make alignment marks between the bolt head and cylinder head prior to tightening; the marks can then be used to check that the bolt has been rotated through the correct angle during tightening.

**35** Where necessary, refit the camshaft and/or camshaft sprocket (see Sections 9 and 11). If the cylinder head has been overhauled, check the valve clearances before proceeding.

**36** Ensure the engine/transmission unit is securely supported then remove the mounting bracket from the right-hand engine/trans-

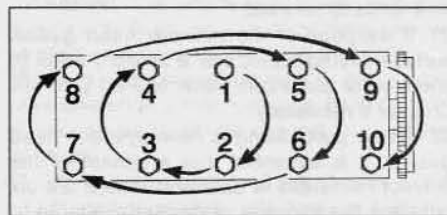

**13.32** Cylinder head bolt tightening sequence – 1.9 litre engines

mission mounting. Refit the bolt securing the bracket to the cylinder head and tighten it to the specified torque.

**37** Refit the timing belt as described in Section 7.

**38** Refit the coolant pipe bolt and securely reconnect the glow plug wiring.

**39** Ensure the mating surfaces are clean and dry then refit the fuel filter/thermostat housing to the cylinder head, using a new gasket. Fit the housing retaining bolts, ensuring the sealing washer is fitted to the bolt located inside the filter housing, and tighten them to the specified torque. Reconnect the coolant hose securely to the housing.

**40** Fit a new sealing ring to the base of the fuel filter plastic housing and refit the housing, tightening its bolt to the specified torque.

**41** Refit the cylinder cover (see Section 4).

**42** Referring to Chapter 4C, carry out the following.

- Refit the injectors (where removed).
- Refit the fuel pipes connecting the injection pump to the injectors and reconnect the leak off hoses to the injectors.
- Refit the manifolds and air cleaner housing.

**43** Refit the braking system vacuum pump as described in Chapter 9.

**44** Fit a new fuel filter and refill the cooling system as described in Chapter 1B.

**45** Reconnect the battery, then prime and bleed the fuel system as described in Chapter 4C.

## 14 Sump – removal and refitting

### Removal

**1** Firmly apply the handbrake, then jack up the front of the car and support it securely on axle stands (*see Jacking and vehicle support*). Disconnect the battery negative terminal (refer to *Disconnecting the battery* in the Reference Chapter).

**2** Where necessary, remove the retaining bolts, screws and clips and remove the undercover from beneath the engine/transmission unit.

**3** Drain the engine oil, then clean and refit the engine oil drain plug, tightening it to the specified torque. If the engine is nearing its service interval when the oil and filter are due for renewal, it is recommended that the filter is also removed, and a new one fitted. After reassembly, the engine can then be refilled with fresh oil. Refer to Chapter 1B for further information.

**4** On models with air conditioning, remove the auxiliary drivebelt as described in Chapter 1B. Unscrew the compressor mounting bolts and nuts. Free the compressor from the sump and support its weight by tying it to the vehicle, to prevent any excess strain being placed on the compressor lines. Take care not to lose the spacers from the compressor rear mountings (where fitted).



**Caution:** Do not disconnect the refrigerant lines from the compressor (refer to the warnings given in Chapter 3). Ensure the compressor is securely supported to prevent the refrigerant lines being damaged.

**5** Progressively slacken and remove all the sump retaining bolts. On some models, it may be necessary to unbolt the flywheel cover plate from the transmission to gain access to the left-hand sump fasteners.

**6** Progressively slacken and remove all the sump retaining bolts/nuts. Since the sump bolts vary in length, remove each bolt in turn, and store it in its correct fitted order by pushing it through a clearly-marked cardboard template. This will avoid the possibility of installing the bolts in the wrong locations on refitting.

**7** Try to break the joint by striking the sump with the palm of your hand, then lower and withdraw the sump from under the car. If the sump is stuck (which is quite likely) use a putty knife, or similar, carefully inserted between the sump and block. Ease the knife along the joint until the sump is released. While the sump is removed, take the opportunity to check the oil pump pick-up/strainer for signs of clogging or splitting. If necessary, remove the pump as described in Section 15, and clean or renew the strainer. Note that on later 2.0 litre engine, the oil dipstick tube extends to the bottom of the sump in order to allow the oil to sucked out of the tube using special equipment.

### Refitting

**8** Clean all traces of sealant from the mating surfaces of the cylinder block/crankcase and

sump, then use a clean rag to wipe out the sump and the engine's interior.

**9** Apply a thin coating of suitable sealant to the sump mating surface.

**10** On models with air conditioning ensure the sump locating dowel(s) is/are correctly fitted (as applicable).

**11** Offer up the sump to the cylinder block/crankcase and refit its retaining bolts. Tighten all bolts by hand then evenly and progressively tighten them to the specified torque setting.

**12** Where necessary, ensure the spacers (where fitted) are correctly located to the rear mountings then align the air conditioning compressor with the sump. Refit the mounting bolts and nuts; tighten compressor front (drivebelt pulley end) mounting bolts to the specified torque first, then tighten the rear mounting bolts to the specified torque (see Chapter 3). Refit the auxiliary drivebelt as described in Chapter 1B.

**13** Refit the undercover (where fitted) then lower the vehicle to the ground and refill the engine with oil (see Chapter 1B).

## 15 Oil pump – removal, inspection and refitting

### Removal

**1** Remove the sump (see Section 14).

**2** Unscrew the bolt securing the dipstick guide tube to the oil pump and remove the

guide tube from the cylinder block (see illustrations).

**3** On 1.9 litre engines slacken and remove the three bolts securing the oil pump in position, noting the correct fitted location of the longer bolt. Disengage the pump sprocket from the chain, and remove the oil pump and spacer plate from the engine.

**4** On 2.0 litre engines slacken and remove the three bolts securing the oil pump in position, noting the correct fitted location of the each bolt (they are all different sizes) and the sealing washer (see illustration). Disengage the pump sprocket from the chain, and remove the oil pump from the engine.

### Inspection

**5** Examine the oil pump sprocket for signs of damage and wear, such as chipped or missing teeth. If the sprocket is worn, the pump assembly must be renewed, as the sprocket is not available separately. It is also recommended that the chain and drive sprocket, fitted to the crankshaft, is renewed at the same time. The oil pump drive sprocket and chain can be removed with the engine *in situ*, once the crankshaft sprocket has been removed and the crankshaft oil seal housing has been unbolted. See Part E for further information.

**6** Slacken and remove the bolts securing the strainer cover to the pump body, then lift off the strainer cover. Remove the relief valve piston and spring (and guide pin – 2.0 litre engines only), noting which way round they are fitted (see illustrations).

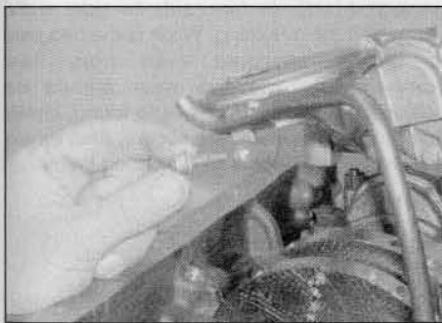

15.2a Unscrew the bolt securing the dipstick guide tube to the oil pump ...

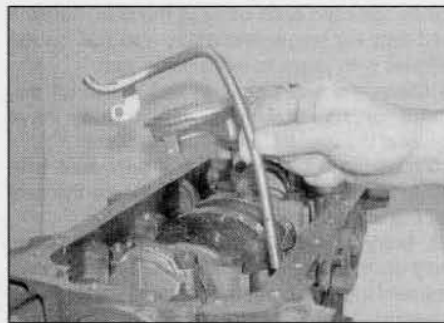

15.2b ... then remove the guide tube from the block (shown with engine removed)

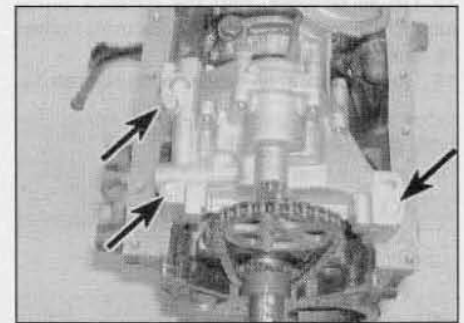

15.4 Note the correct fitted location of each oil pump retaining bolt (arrowed) as it is removed – 2.0 litre engines

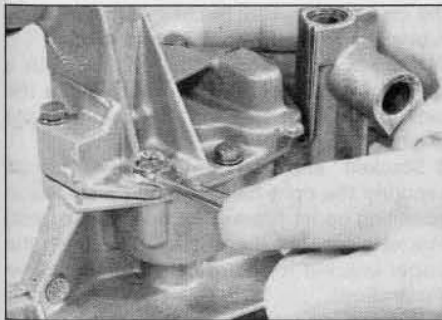

15.6a Unscrew the retaining bolts ...

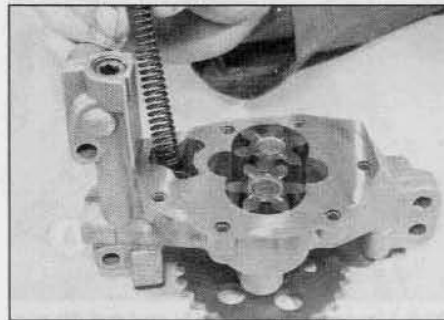

15.6b ... then lift off the cover and remove the spring ...

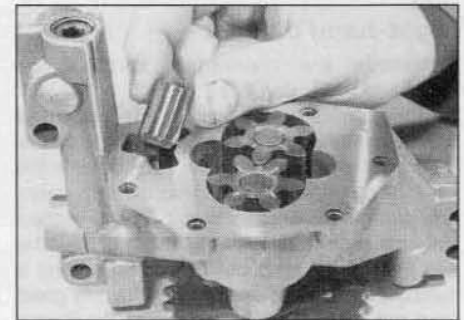

15.6c ... and relief valve piston, noting which way around it is fitted



7 Examine the pump rotors and body for signs of wear ridges and scoring. If worn, the complete pump assembly must be renewed.

8 Examine the relief valve piston for signs of wear or damage, and renew if necessary. The condition of the relief valve spring can only be measured by comparing it with a new one; if there is any doubt about its condition, it should also be renewed. Both the piston and spring are available individually.

9 Thoroughly clean the oil pump strainer with a suitable solvent, and check it for signs of clogging or splitting. If the strainer is damaged, the strainer and cover assembly must be renewed.

10 Locate the relief valve spring, piston and (where fitted) the guide pin in the strainer cover, then refit the cover to the pump body. Align the relief valve piston with its bore in the pump. Refit the cover retaining bolts, tightening them securely.

### Refitting

11 On 1.9 litre engines, fit the spacer plate then offer up the pump, engaging the pump sprocket with its drive chain. Refit the pump retaining bolts, ensuring the longer bolt is fitted to the rear hole, and tighten them to the specified torque setting.

12 On 2.0 litre engines, engage the pump sprocket with the drive chain then install the retaining bolts. Fit the sealing washer to the rear bolt then install the pump retaining bolts, ensuring they are fitted in their original locations. Tighten the bolts to the specified torque.

13 On all engines, refit the dipstick guide tube to the cylinder block and securely tighten its retaining bolt.

14 Refit the sump as described in Section 14.

### 16 Engine oil cooler – removal and refitting

Refer to Chapter 2B, Section 19.

### 17 Crankshaft oil seals – renewal

#### Right-hand oil seal

1 Remove the crankshaft sprocket as described in Section 9.

2 Make a note of the correct fitted depth of the seal in its housing then carefully punch or drill two small holes opposite each other in the seal. Screw a self-tapping screw into each, and pull on the screws with pliers to extract the seal (see illustration). Alternatively, the seal can be levered out of position using a suitable flat-bladed screwdriver, taking great care not to damage the oil pump drive gear shoulder or seal housing.

3 Clean the seal housing, and polish off any

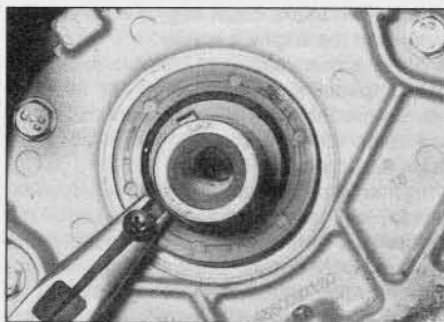

17.2 Using a self-tapping screw and pliers to remove the crankshaft right-hand oil seal

burrs or raised edges, which may have caused the seal to fail in the first place.

4 Lubricate the lips of the new seal with clean engine oil, and carefully locate the seal on the end of crankshaft. Note that its sealing lip must face inwards. Take care not to damage the seal lips during fitting.

5 Using a suitable tubular drift (such as a socket) which bears only on the hard outer edge of the seal, tap the seal into position to the same depth in the housing as the original was prior to removal. The inner face of the seal must be flush with the inner wall of the crankcase.

6 Wash off any traces of oil, then refit the crankshaft sprocket as described in Section 9.

#### Left-hand oil seal

7 Remove the flywheel as described in Section 19.

8 Make a note of the correct fitted depth of the seal in its housing. Punch or drill two small holes opposite each other in the seal. Screw a self-tapping screw into each, and pull on the screws with pliers to extract the seal.

9 Clean the seal housing, and polish off any burrs or raised edges, which may have caused the seal to fail in the first place.

10 Lubricate the lips of the new seal with clean engine oil, and carefully locate the seal on the end of the crankshaft.

11 Using a suitable tubular drift, which bears only on the hard outer edge of the seal, drive the seal into position, to the same depth in the housing as the original was prior to removal.

12 Wash off any traces of oil, then refit the flywheel as described in Section 19.

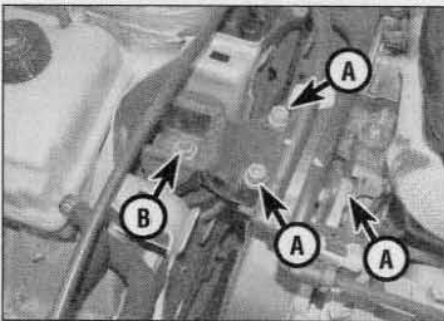

20.8 Unscrew the bolts (A) and nut (B) and remove the bracket from the top of the right-hand mounting – 1.9 litre engines

### 18 Oil level and pressure sensors – general

Refer to Chapter 5A.

### 19 Flywheel – removal, inspection and refitting

Refer to Chapter 2B, Section 18.

### 20 Engine/transmission mountings – inspection and renewal

#### Inspection

1 If improved access is required, raise the front of the car and support it on axle stands (see *Jacking and vehicle support*).

2 Check the mounting rubber to see if it is cracked, hardened or separated from the metal at any point; renew the mounting if any such damage or deterioration is evident.

3 Check that all the mounting's fasteners are securely tightened; use a torque wrench to check if possible.

4 Using a large screwdriver or a crowbar, check for wear in the mounting by carefully levering against it to check for free play. Where this is not possible, enlist the aid of an assistant to move the engine/transmission back-and-forth, or from side-to-side, while you watch the mounting. While some free play is to be expected even from new components, excessive wear should be obvious. If excessive free play is found, check first that the fasteners are secure, then renew any worn components as described below.

#### Renewal

##### Right-hand mounting – 1.9 litre engines

5 Disconnect the battery negative terminal (refer to *Disconnecting the battery* in the Reference Chapter).

6 Remove the fasteners from the right-hand side and top of the engine cover then lift off the cover, taking care not to lose its mounting rubbers (see illustrations 4.1a to 4.1c).

7 Place a jack beneath the engine, with a block of wood on the jack head. Raise the jack until it is supporting the weight of the engine.

8 Slacken and remove the three bolts securing the right-hand engine/transmission mounting upper bracket to the lower (engine) bracket. Unscrew the single nut securing the upper bracket to the rubber mounting (see illustration).

9 Remove the upper bracket from the rubber mounting and lower (engine) bracket, then lift off the rubber buffer plate (where fitted).



**20.21 Unscrew the domed buffer nut from the top of the mounting to gain access to the mounting nut – 2.0 litre engines**

- 10 Using a strap wrench or similar tool, unscrew the rubber mounting from the body. Alternatively, fabricate a tool from suitable metal tube with projections to engage in the cut-outs in the mounting.
- 11 Check for signs of wear or damage on all components, and renew as necessary.
- 12 On reassembly, screw the mounting rubber into the body, tightening it securely.
- 13 Refit the rubber buffer plate, then install the upper mounting bracket, tightening its retaining bolts and nut to their specified torque settings.
- 14 Remove the jack from under the engine
- then reconnect the battery negative lead and refit the engine cover.
- Right-hand mounting – 2.0 litre engines**
- 15 Disconnect the battery negative terminal (refer to *Disconnecting the battery* in the Reference Chapter).
- 16 Turn the four plastic fasteners through 90° and lift off the engine cover (see illustrations 6.25a and 6.25b).
- 17 Remove the engine undercover, then place a jack beneath the engine, with a block of wood on the jack head. Raise the jack until it is supporting the weight of the engine.
- 18 On early engines, undo the EGR solenoid valve mounting bracket bolt and move the valve to one side.
- 19 Undo the two bolts securing the right-hand mounting stiffener bracket to the body and lift off the bracket, complete with the accelerator pedal position sensor on later engines (see illustration 6.31).
- 20 Slacken and remove the three bolts securing the right-hand engine/transmission mounting upper bracket to the lower (engine) bracket.
- 21 Unscrew the domed buffer nut, then unscrew the single nut securing the upper bracket to the rubber mounting (see illustration).
- 22 Remove the upper bracket from the rubber mounting and lower (engine) bracket, then lift off the rubber buffer plate.
- 23 Using a strap wrench or similar tool, unscrew the rubber mounting from the body. Alternatively, fabricate a tool from suitable metal tube with projections to engage in the cut-outs in the mounting.
- 24 Check for signs of wear or damage on all components, and renew as necessary.
- 25 On reassembly, screw the mounting rubber into the body, tightening it securely.
- 26 Refit the rubber buffer plate, then install the upper mounting bracket, tightening its retaining bolts and nut to their specified torque settings.
- 27 Refit the stiffener bracket and secure with the two retaining bolts, tightened to the specified torque. On early engines, refit the EGR solenoid valve mounting bracket to the stiffener bracket, insert the retaining bolt and tighten the bolt securely.
- 28 Remove the jack from under the engine then refit the undercover. Reconnect the battery negative lead then refit the engine cover.
- Left-hand mounting**
- 29 Refer to Chapter 2B, Section 20.
- Rear mounting**
- 30 Refer to Chapter 2A, Section 16.





# Chapter 2 Part D:

## Petrol engine removal and overhaul procedures

### Contents

	Section number		Section number
Crankshaft – inspection .....	13	Engine overhaul – reassembly sequence .....	15
Crankshaft – refitting .....	17	Engine/transmission removal – methods and precautions .....	3
Crankshaft – removal .....	10	Engine/transmission – removal and refitting .....	4
Cylinder block/crankcase – cleaning and inspection .....	11	General information .....	1
Cylinder head – dismantling .....	6	Main and big-end bearings – inspection .....	14
Cylinder head – reassembly .....	8	Piston/connecting rod assembly – inspection .....	12
Cylinder head and valves – cleaning and inspection .....	7	Piston/connecting rod assembly – refitting .....	18
Engine – initial start-up after overhaul .....	19	Piston/connecting rod assembly – removal .....	9
Engine overhaul – dismantling sequence .....	5	Piston rings – refitting .....	16
Engine overhaul – general information .....	2		

### Degrees of difficulty

**Easy**, suitable for novice with little experience



**Fairly easy**, suitable for beginner with some experience



**Fairly difficult**, suitable for competent DIY mechanic



**Difficult**, suitable for experienced DIY mechanic



**Very difficult**, suitable for expert DIY or professional



### Specifications

#### Cylinder head

Maximum gasket face distortion .....	0.05 mm
New cylinder head height:	
1.4 litre engines .....	111.20 mm
1.6 litre engines .....	N/A
Minimum cylinder head height after machining:	
1.4 litre engines .....	111.00 mm
1.6 litre engines .....	N/A

#### Valves

Valve head diameter:	<b>Inlet</b>	<b>Exhaust</b>
1.4 litre engines .....	36.7 mm	29.4 mm
1.6 litre engines .....	N/A	N/A
Valve stem diameter:		
1.4 litre engines .....	6.965 to 6.980 mm	6.945 to 6.960 mm
1.6 litre engines .....	N/A	N/A

#### Cylinder block

Cylinder bore diameter:	
1.4 litre engines .....	75.00 mm (nominal)
1.6 litre engines .....	78.50 mm (nominal)
Liner protrusion – 1.4 litre engines:	
Standard .....	0.03 to 0.10 mm
Maximum difference between any two liners .....	0.05 mm

**Pistons**

Piston diameter:

1.4 litre engines .....	74.950 mm (nominal)
1.6 litre engines .....	78.455 mm (nominal)

Check with your Peugeot/Citroën dealer or engine specialist regarding piston oversizes

**Crankshaft**

Endfloat .....	0.07 to 0.27 mm
Main bearing journal diameter .....	49.965 to 49.981 mm
Big-end bearing journal diameter .....	44.975 to 44.991 mm

**Piston rings**

End gaps:

Top compression ring .....	0.20 to 0.45 mm
Second compression ring .....	0.30 to 0.50 mm
Oil control ring .....	0.30 to 0.50 mm

**Torque wrench settings**

Refer to Chapter 2A Specifications

**1 General information**

Included in this Part of Chapter 2 are details of removing the engine/transmission from the car and general overhaul procedures for the cylinder head, cylinder block/crankcase and all other engine internal components.

The information given ranges from advice concerning preparation for an overhaul and the purchase of new parts, to detailed step-by-step procedures covering removal, inspection, renovation and refitting of engine internal components.

After Section 5, all instructions are based on the assumption that the engine has been removed from the car. For information concerning in-car engine repair, as well as the removal and refitting of those external components necessary for full overhaul, refer to Part A of this Chapter, and to Section 5. Ignore any preliminary dismantling operations described in Part A that are no longer relevant once the engine has been removed from the car.

Apart from torque wrench settings, which are given at the beginning of Part A, all specifications relating to engine overhaul are at the beginning of this Part of Chapter 2.

**2 Engine overhaul – general information**

It is not always easy to determine when, or if, an engine should be completely overhauled, as a number of factors must be considered.

High mileage is not necessarily an indication that an overhaul is needed, while low mileage does not preclude the need for an overhaul. Frequency of servicing is probably the most important consideration. An engine which has had regular and frequent oil and

filter changes, as well as other required maintenance, should give many thousands of miles of reliable service. Conversely, a neglected engine may require an overhaul very early in its life.

Excessive oil consumption is an indication that piston rings, valve seals and/or valve guides are in need of attention. Make sure that oil leaks are not responsible before deciding that the rings and/or guides are worn. Perform a compression test, as described in Part A of this Chapter, to determine the likely cause of the problem.

Check the oil pressure with a gauge fitted in place of the oil pressure switch, and compare it with that specified. If it is extremely low, the main and big-end bearings, and/or the oil pump, are probably worn out.

Loss of power, rough running, knocking or metallic engine noises, excessive valve gear noise, and high fuel consumption may also point to the need for an overhaul, especially if they are all present at the same time. If a complete service does not remedy the situation, major mechanical work is the only solution.

A full engine overhaul involves restoring all internal parts to the specification of a new engine. During a complete overhaul, the pistons and the piston rings are renewed, and the cylinder bores are reconditioned. New main and big-end bearings are generally fitted; if necessary, the crankshaft may be reground, to compensate for wear in the journals. The valves are also serviced as well, since they are usually in less-than-perfect condition at this point. Always pay careful attention to the condition of the oil pump when overhauling the engine, and renew it if there is any doubt as to its serviceability. The end result should be an as-new engine that will give many trouble-free miles.

Critical cooling system components such as the hoses, thermostat and water pump should be renewed when an engine is overhauled. The radiator should be checked carefully, to ensure that it is not clogged or

leaking. Also, it is a good idea to renew the oil pump whenever the engine is overhauled.

Before beginning the engine overhaul, read through the entire procedure, to familiarise yourself with the scope and requirements of the job. Check on the availability of parts and make sure that any necessary special tools and equipment are obtained in advance. Most work can be done with typical hand tools, although a number of precision measuring tools are required for inspecting parts to determine if they must be renewed.

The services provided by an engineering machine shop or engine reconditioning specialist will almost certainly be required, particularly if major repairs such as crankshaft regrinding or cylinder reboring are necessary. Apart from carrying out machining operations, these establishments will normally handle the inspection of parts, offer advice concerning reconditioning or renewal and supply new components such as pistons, piston rings and bearing shells. It is recommended that the establishment used is a member of the Federation of Engine Re-Manufacturers, or a similar society.

Always wait until the engine has been completely dismantled, and until all components (especially the cylinder block/crankcase and the crankshaft) have been inspected, before deciding what service and repair operations must be performed by an engineering works. The condition of these components will be the major factor to consider when determining whether to overhaul the original engine, or to buy a reconditioned unit. Do not, therefore, purchase parts or have overhaul work done on other components until they have been thoroughly inspected. As a general rule, time is the primary cost of an overhaul, so it does not pay to fit worn or sub-standard parts.

As a final note, to ensure maximum life and minimum trouble from a reconditioned engine, everything must be assembled with care, in a spotlessly-clean environment.

### 3 Engine/transmission removal – methods and precautions

If you have decided that the engine must be removed for overhaul or major repair work, several preliminary steps should be taken.

Locating a suitable place to work is extremely important. Adequate work space, along with storage space for the car, will be needed. If a workshop or garage is not available, at the very least, a flat, level, clean work surface is required.

Cleaning the engine compartment and engine/transmission before beginning the removal procedure will help keep tools clean and organised.

An engine hoist will also be necessary. Make sure the equipment is rated in excess of the combined weight of the engine and transmission. Safety is of primary importance, considering the potential hazards involved in removing the engine/transmission from the car.

The help of an assistant is essential. Apart from the safety aspects involved, there are many instances when one person cannot simultaneously perform all of the operations required during engine/transmission removal.

Plan the operation ahead of time. Before starting work, arrange for the hire of or obtain all of the tools and equipment you will need. Some of the equipment necessary to perform engine/transmission removal and installation safely (in addition to an engine hoist) is as follows: a heavy duty trolley jack, complete sets of spanners and sockets as described in the rear of this manual, wooden blocks, and plenty of rags and cleaning solvent for mopping-up spilled oil, coolant and fuel. If the hoist must be hired, make sure that you arrange for it in advance, and perform all of the operations possible without it beforehand. This will save you money and time.

Plan for the car to be out of use for quite a while. An engineering machine shop or engine reconditioning specialist will be required to perform some of the work which cannot be accomplished without special equipment. These places often have a busy schedule, so it would be a good idea to consult them before removing the engine, in order to accurately estimate the amount of time required to rebuild or repair components that may need work.

During the engine/transmission removal procedure, it is advisable to make notes of the locations of all brackets, cable ties, earthing points, etc, as well as how the wiring harnesses, hoses and electrical connections are attached and routed around the engine and engine compartment. An effective way of doing this is to take a series of photographs of the various components before they are disconnected or removed; the resulting photographs will prove invaluable when the engine/transmission is refitted.

Always be extremely careful when removing and refitting the engine/transmission. Serious injury can result from careless actions. Plan ahead and take your time, and a job of this nature, although major, can be accomplished successfully.

The engine and transmission assembly is removed and refitted as follows:

- a) *Upwards from the engine compartment on pre-September 2002 models.*
- b) *Downwards from the engine compartment on September 2002 models onward.*

### 4 Engine/transmission – removal and refitting



**Note:** *Such is the complexity of the power unit arrangement on these vehicles, and the variations that may be encountered according to model and optional equipment fitted, that the following should be regarded as a guide to the work involved, rather than a step-by-step procedure. Where differences are encountered, or additional component disconnection or removal is necessary, make notes of the work involved as an aid to refitting.*

#### Removal

**Note:** *The engine can be removed from the car only as a complete unit with the transmission; the two are then separated for overhaul.*

- 1 Remove the battery, battery tray and mounting plate as described in see Chapter 5A.
- 2 Apply the handbrake, then jack up the front of the vehicle and support it on axle stands (see *Jacking and vehicle support*). Remove both front roadwheels.
- 3 Where fitted, remove the plastic cover from the top of the engine.
- 4 To improve access, remove the bonnet as described in Chapter 11.
- 5 Remove the air cleaner housing and intake ducting as described in Chapter 4A.
- 6 Drain the cooling system with reference to Chapter 1A.
- 7 Drain the transmission oil as described in Chapter 7. Refit the drain and filler plugs, and tighten them to their specified torque settings.
- 8 If the engine is to be dismantled, drain the engine oil and remove the oil filter as described in Chapter 1A. Clean and refit the drain plug, tightening it securely.
- 9 Remove both the front wheel arch liners. The liners are secured by various screws and clips under the wheel arch. Release all the fasteners, and remove liners from under the front wings.
- 10 Refer to Chapter 1A and remove the auxiliary drivebelt.
- 11 Refer to Chapter 8 and remove both front driveshafts.

12 Disconnect the radiator top and bottom hoses, the heater hoses at the engine compartment bulkhead, and the expansion tank hose. On September 2002 models onward, remove the radiator as described in Chapter 3.

13 On models with air conditioning, refer to Chapter 3 and unbolt the compressor from the engine. **Do not** disconnect the refrigerant lines. Support or tie the compressor to one side.

14 On models with power steering, remove the power steering pump as described in Chapter 10.

15 Remove the exhaust system with reference to Chapter 4A.

16 Note their fitted positions and harness routing, then disconnect all relevant wiring plugs from the transmission. If necessary label the connectors as they are unplugged.

17 Disconnect the engine wiring harness connectors at the fusebox, fuel injection relay and front body panel (as applicable). Release the wiring harness from the retaining clips and ties so the harness is free to be removed with the engine.

18 Disconnect the engine earth leads at the fusebox, under the left-hand wheel arch and on the left-hand chassis member.

19 Disconnect the brake servo unit vacuum pipe from the inlet manifold.

20 Disconnect the accelerator cable with reference to Chapter 4A.

21 Where fitted, on later engines, undo the two bolts securing the right-hand engine mounting stiffener bracket to the body and lift off the bracket, complete with the accelerator pedal position sensor.

22 Disconnect the fuel feed and return hoses and plug the hoses and unions to prevent dirt ingress. Release the fuel hoses from the retaining clips on the engine and move them aside.

23 Disconnect the clutch cable from the release lever and transmission bracket as described in Chapter 6.

24 Disconnect the gearchange selector mechanism from the transmission as described in Chapter 7.

25 Using a hoist attached to the lifting eyes on the cylinder head, take the weight of the engine and transmission.

26 Remove the right-hand, left-hand and rear engine mountings and support brackets as described in Chapter 2A.

27 Make a final check to ensure all wiring, hoses and brackets that would prevent the removal of the assembly have been disconnected.

28 On pre-September 2002 models, lift the engine/transmission assembly from the engine compartment, ensuring that nothing is trapped or damaged. Enlist the help of an assistant during this procedure as it will be necessary to tilt the assembly slightly to clear the body panels. Once the unit is high enough, lift it out over the front of the body and lower it to the ground.



29 On September 2002 models onward, carefully lower the engine/transmission from the engine compartment taking care not to damage the surrounding components. Ideally lower the unit onto a low trolley so that it may be withdrawn from under the car. Disconnect the hoist from the engine/transmission assembly.

### Separation

30 With the engine/transmission assembly removed, support the assembly on suitable blocks of wood on a workbench (or failing that, on a clean area of the workshop floor).

31 Undo the retaining bolts, and remove the flywheel lower cover plate (where fitted) from the transmission.

32 Slacken and remove the retaining bolts, and remove the starter motor from the transmission.

33 Disconnect any remaining wiring connectors at the transmission, then move the main engine wiring harness to one side.

34 Ensure that both engine and transmission are adequately supported, then slacken and remove the remaining bolts securing the transmission housing to the engine. Note the correct fitted positions of each bolt (and the relevant brackets) as they are removed, to use as a reference on refitting.

35 Carefully withdraw the transmission from the engine, ensuring that the weight of the transmission is not allowed to hang on the input shaft while it is engaged with the clutch friction disc.

36 If they are loose, remove the locating dowels from the engine or transmission, and keep them in a safe place.

### Refitting

37 If the engine and transmission have not been separated, perform the operations described below from paragraph 44 onwards.

38 Apply a smear of high melting-point grease (Peugeot/Citroën recommend the use of Molykote BR2 plus) to the splines of the transmission input shaft. Do not apply too much, otherwise there is a possibility of the grease contaminating the clutch friction disc.

39 Ensure that the locating dowels are correctly positioned in the engine or transmission.

40 Carefully offer the transmission to the engine, until the locating dowels are engaged. Ensure that the weight of the transmission is not allowed to hang on the input shaft as it is engaged with the clutch friction disc.

41 Refit the transmission housing-to-engine bolts, ensuring that all the necessary brackets are correctly positioned, and tighten them to the specified torque.

42 Refit the starter motor, and securely tighten its retaining bolts.

43 Refit the lower flywheel cover plate (where fitted) to the transmission, and securely tighten the bolts.

44 Position the engine/transmission assembly

ready for installation, then reconnect the hoist and lifting tackle. With the aid of an assistant, locate the assembly into the engine compartment, using the same procedure as for removal.

45 Refit the right-hand, left-hand and rear engine mountings and support brackets as described in Chapter 2A.

46 Remove the hoist from the engine.

47 The remainder of the refitting procedure is a direct reversal of the removal sequence, with reference to the relevant chapters and noting the following points:

- Ensure that the wiring loom is correctly routed and retained by all the relevant retaining clips; all connectors should be correctly and securely reconnected.
- Ensure that all coolant hoses are correctly reconnected, and securely retained by their retaining clips.
- Refill the engine and transmission with the correct quantity and type of lubricant, as described in Chapters 1A and 7.
- Refill the cooling system as described in Chapter 1A.
- Pressurise/prime the fuel system as described in Chapter 4A.
- Bleed the power steering system as described in Chapter 10.
- Initialise the engine management ECU as follows. Start the engine and run to normal temperature. Carry out a road test during which the following procedure should be made. Engage third gear and stabilise the engine at 1000 rpm. Now accelerate fully to 3500 rpm.

## 5 Engine overhaul – dismantling sequence

1 It is much easier to dismantle and work on the engine if it is mounted on a portable engine stand. These stands can often be hired from a tool hire shop. Before the engine is mounted on a stand, the flywheel should be removed, so that the stand bolts can be tightened into the end of the cylinder block/crankcase.

2 If a stand is not available, it is possible to dismantle the engine with it blocked up on a sturdy workbench, or on the floor. Be extra careful not to tip or drop the engine when working without a stand.

3 If you are going to obtain a reconditioned engine, all the external components must be removed first, to be transferred to the new engine (just as they will if you are doing a complete engine overhaul yourself). These components include the following:

- Ancillary unit mounting brackets (oil filter, starter, alternator, power steering pump, etc)
- Thermostat and housing (Chapter 3).
- Dipstick tube/sensor.
- All electrical switches and sensors.

e) Inlet and exhaust manifolds – where applicable (Chapter 4A).

f) Ignition coils and spark plugs – as applicable (Chapter 5B and 1A).

g) Flywheel (Part A of this Chapter).

**Note:** When removing the external components from the engine, pay close attention to details that may be helpful or important during refitting. Note the fitted position of gaskets, seals, spacers, pins, washers, bolts, and other small items.

4 If you are obtaining a 'short' engine (which consists of the engine cylinder block/crankcase, crankshaft, pistons and connecting rods all assembled), then the cylinder head, sump, oil pump, and timing belt will have to be removed also.

5 If you are planning a complete overhaul, the engine can be dismantled, and the internal components removed, in the order given below, referring to Part A of this Chapter unless otherwise stated.

- Inlet and exhaust manifolds – where applicable (Chapter 4A).
- Timing belts, sprockets and tensioner(s).
- Cylinder head.
- Flywheel.
- Sump.
- Oil pump.
- Piston/connecting rod assemblies (Section 9).
- Crankshaft (Section 10).

6 Before beginning the dismantling and overhaul procedures, make sure that you have all of the correct tools necessary. Refer to *Tools and working facilities* for further information.

## 6 Cylinder head – dismantling



**Note:** New and reconditioned cylinder heads are available from the manufacturer, and from engine overhaul specialists. Be aware that some specialist tools are required for the dismantling and inspection procedures, and new components may not be readily available. It may therefore be more practical and economical for the home mechanic to purchase a reconditioned head, rather than dismantle, inspect and recondition the original head.

1 Remove the cylinder head as described in Part A of this Chapter.

2 If not already done, remove the inlet and exhaust manifolds with reference to Chapter 4A. Remove any remaining brackets or housings as required.

3 Remove the camshaft(s), hydraulic tappets and rockers (as applicable) as described in Part A of this Chapter.

4 If not already done, remove the spark plugs as described in Chapter 1A.

5 Using a valve spring compressor, compress

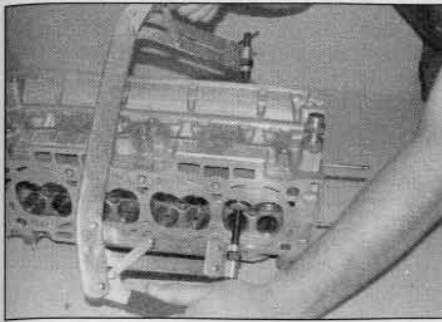

**6.5 Compress the valve spring using a spring compressor until the collets can be removed**

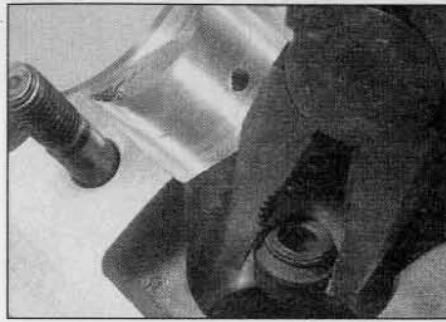

**6.7 Use a pair of pliers to remove the valve stem oil seal**

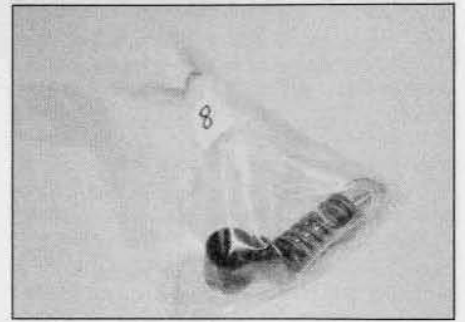

**6.8 Place each valve and its associated components in a labelled bag**

each valve spring in turn until the split collets can be removed (see illustration). Release the compressor, and lift off the spring retainer and spring.

**6** If, when the valve spring compressor is screwed down, the spring retainer refuses to free and expose the split collets, gently tap the top of the tool, directly over the retainer, with a light hammer. This will free the retainer.

**7** Withdraw the valve from the combustion chamber then, using a pair of pliers, carefully extract the valve stem oil seal from the top of the guide (see illustration). Lift out the spring seat, where fitted.

**8** It is essential that each valve is stored together with its collets, retainer, spring, and spring seat. The valves should also be kept in their correct sequence, unless they are so badly worn that they are to be renewed. If they are going to be kept and used again, place each valve assembly in a labelled polythene bag or similar small container (see illustration). Note that No 1 valve is nearest to the transmission (flywheel) end of the engine.

## 7 Cylinder head and valves – cleaning and inspection

**1** Thorough cleaning of the cylinder head and valve components, followed by a detailed inspection, will enable you to decide how much valve service work must be carried out during the engine overhaul. **Note:** If the engine has been severely overheated, it is best to assume that the cylinder head is warped – check carefully for signs of this.

### Cleaning

**2** Scrape away all traces of old gasket material from the cylinder head.

**3** Scrape away the carbon from the combustion chambers and ports, then wash the cylinder head thoroughly with paraffin or a suitable solvent.

**4** Scrape off any heavy carbon deposits that may have formed on the valves, then use a power-operated wire brush to remove deposits from the valve heads and stems.

### Inspection

**Note:** Be sure to perform all the following inspection procedures before concluding that the services of a machine shop or engine overhaul specialist are required. Make a list of all items that require attention.

### Cylinder head

**5** Inspect the head very carefully for cracks, evidence of coolant leakage, and other damage. If cracks are found, a new cylinder head should be obtained. Use a straight-edge and feeler blade to check that the cylinder head gasket surface is not distorted (see illustration). If it is, it may be possible to have it machined, provided that the cylinder head height is not significantly reduced.

**6** Examine the valve seats in each of the combustion chambers. If they are severely pitted, cracked, or burned, they will need to be renewed or recut by an engine overhaul specialist. If they are only slightly pitted, this can be removed by grinding-in the valve heads and seats with fine valve-grinding compound, as described below.

**7** Check the valve guides for wear by inserting the relevant valve, and checking for side-to-side motion of the valve. A very small amount of movement is acceptable. If the movement seems excessive, remove the valve. Measure the valve stem diameter (see below), and renew the valve if it is worn. If the valve stem is not worn, the wear must be in the valve guide, and the guide must be renewed. The renewal of valve guides is best carried out by an engine overhaul specialist,



**7.5 Check the cylinder head gasket surface for distortion**

who will have the necessary tools available. Where no valve stem diameter is specified, seek the advice of a Peugeot/Citroën dealer or engine overhaul specialist on the best course of action.

**8** If renewing the valve guides, the valve seats should be recut or reground only after the guides have been fitted.

### Valves

**9** Examine the head of each valve for pitting, burning, cracks, and general wear. Check the valve stem for scoring and wear ridges. Rotate the valve, and check for any obvious indication that it is bent. Look for pits or excessive wear on the tip of each valve stem. Renew any valve that shows any such signs of wear or damage.

**10** If the valve appears satisfactory at this stage, measure the valve stem diameter at several points using a micrometer (see illustration). Any significant difference in the readings obtained indicates wear of the valve stem. Should any of these conditions be apparent, the valve must be renewed.

**11** If the valves are in satisfactory condition, they should be ground (lapped) into their respective seats, to ensure a smooth, gas-tight seal. If the seat is only lightly pitted, or if it has been recut, fine grinding compound only should be used to produce the required finish. Coarse valve-grinding compound should not be used, unless a seat is badly burned or deeply pitted. If this is the case, the cylinder head and valves should be inspected by an expert, to decide whether seat

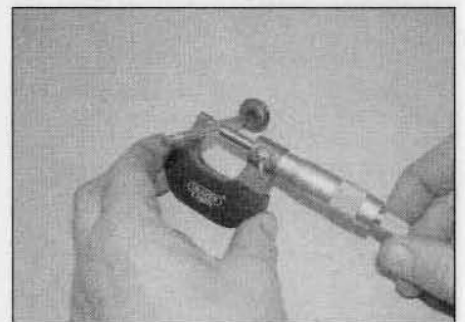

**7.10 Measure the valve stem diameter with a micrometer**



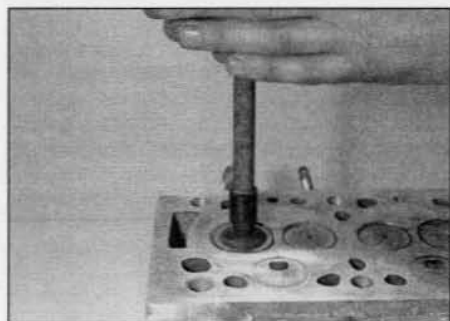

7.13 Grinding-in a valve

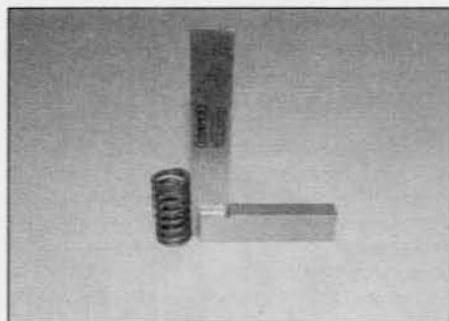

7.17 Check each valve spring for squareness

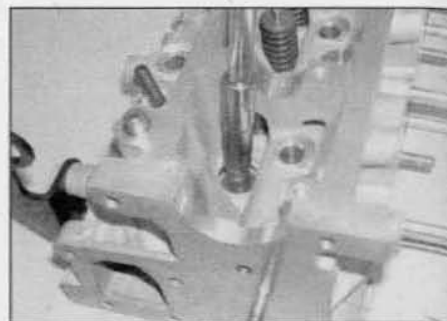

8.1 Press the new oil seal firmly onto the guide using a suitable socket

recutting, or even the renewal of the valve or seat insert (where possible) is required.

**12** Valve grinding is carried out as follows. Place the cylinder head upside-down on a bench.

**13** Smear a trace of (the appropriate grade of) valve-grinding compound on the seat face, and press a suction grinding tool onto the valve head (see illustration). With a semi-rotary action, grind the valve head to its seat, lifting the valve occasionally to redistribute the grinding compound. A light spring placed under the valve head will greatly ease this operation.

**14** If coarse grinding compound is being used, work only until a dull, matt even surface is produced on both the valve seat and the valve, then wipe off the used compound, and repeat the process with fine compound. When

a smooth unbroken ring of light grey matt finish is produced on both the valve and seat, the grinding operation is complete. *Do not* grind-in the valves any further than absolutely necessary, or the seat will be prematurely sunk into the cylinder head.

**15** When all the valves have been ground-in, carefully wash off *all* traces of grinding compound using paraffin or a suitable solvent, before reassembling the cylinder head.

#### Valve components

**16** Examine the valve springs for signs of damage and discoloration. No minimum free length is specified by Peugeot/Citroën, so the only way of judging valve spring wear is by comparison with a new component.

**17** Stand each spring on a flat surface, and check it for squareness (see illustration). If

any of the springs are damaged, distorted or have lost their tension, obtain a complete new set of springs. It is normal to renew the valve springs as a matter of course if a major overhaul is being carried out.

**18** Renew the valve stem oil seals regardless of their apparent condition.

### 8 Cylinder head – reassembly

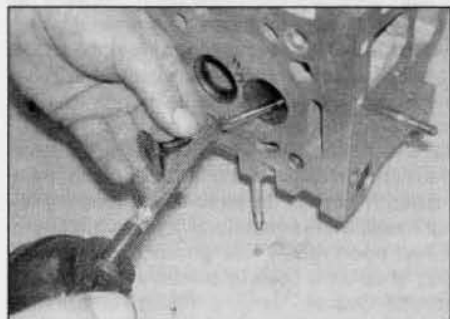

8.2 Lubricate the valve stem and insert it in the guide

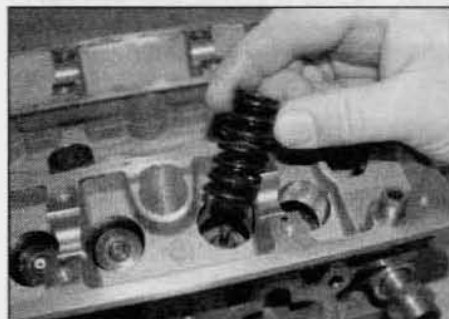

8.3a Fit the valve spring . . .



8.3b . . . then place the spring retainer over the spring

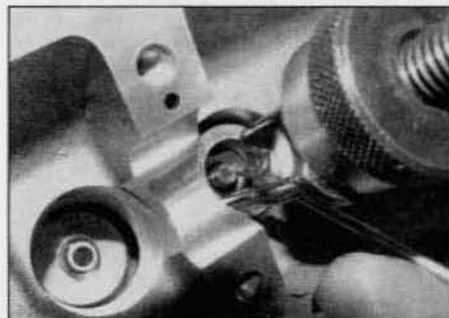

8.4 Compress the valve spring, and locate the collets in the recess in the valve stem

**1** Working on the first valve assembly, refit the spring seat then dip the new valve stem oil seal in fresh engine oil. Locate the seal on the valve guide and press the seal firmly onto the guide using a suitable socket (see illustration).

**2** Lubricate the stem of the first valve, and insert it in the guide (see illustration).

**3** Locate the valve spring on top of its seat, then refit the spring retainer (see illustrations).

**4** Compress the valve spring, and locate the split collets in the recess in the valve stem (see illustration). Release the compressor, then repeat the procedure on the remaining valves. Ensure that each valve is inserted into its original location. If new valves are being fitted, insert them into the locations to which they have been ground.



**Haynes hint:** Use a little dab of grease to hold the collets in position on the valve stem while the spring compressor is released.

**5** With all the valves installed, support the cylinder head and, using a hammer and interposed block of wood, tap the end of each valve stem to settle the components.

**6** Refit the camshafts, hydraulic tappets and rocker arms (as applicable) as described in Part A of this Chapter.

**7** Refit any remaining components using the reverse of the removal sequence and with new seals or gaskets as necessary.

**8** The cylinder head can then be refitted as described in Part A of this Chapter.





9.3 Connecting rod and big-end bearing cap identification marks (No 3 shown)

**9 Piston/connecting rod assembly - removal**

- 1 Remove the cylinder head, sump and oil pump as described in Part A.
- 2 If there is a pronounced wear ridge at the top of any bore, it may be necessary to remove it with a scraper or ridge reamer, to avoid piston damage during removal. Such a ridge indicates excessive wear of the cylinder bore.
- 3 Using quick-drying paint, mark each connecting rod and big-end bearing cap with its respective cylinder number on the flat machined surface provided; if the engine has been dismantled before, note carefully any identifying marks made previously (see illustration). Note that No 1 cylinder is at the transmission (flywheel) end of the engine.
- 4 Turn the crankshaft to bring pistons 1 and 4 to BDC (bottom dead centre).
- 5 Unscrew the nuts or bolts, as applicable, from No 1 piston big-end bearing cap. Take off the cap, and recover the bottom half bearing shell (see illustration). If the bearing shells are to be re-used, tape the cap and the shell together.
- 6 To prevent the possibility of damage to the crankshaft bearing journals, tape over the connecting rod stud threads, where fitted (see illustration).
- 7 Using a hammer handle, push the piston up through the bore, and remove it from the top of the cylinder block. Recover the bearing



9.6 To protect the crankshaft journals, tape over the connecting rod stud threads



9.5 Remove the big-end bearing shell and cap

- shell, and tape it to the connecting rod for safe-keeping.
- 8 Loosely refit the big-end cap to the connecting rod, and secure with the nuts/bolts - this will help to keep the components in their correct order.
  - 9 Remove No 4 piston assembly in the same way.
  - 10 Turn the crankshaft through 180° to bring pistons 2 and 3 to BDC (bottom dead centre), and remove them in the same way.

**10 Crankshaft - removal**

- 1 Remove the crankshaft sprocket and the oil pump as described in Part A of this Chapter.
- 2 Remove the pistons and connecting rods, as described in Section 9. If no work is to be done on the pistons and connecting rods, there is no need to remove the cylinder head, or to push the pistons out of the cylinder bores. The pistons should just be pushed far enough up the bores so that they are positioned clear of the crankshaft journals.
- 3 Check the crankshaft endfloat as described in Section 13, then proceed as follows.

**1.4 litre engines**

- 4 Work around the outside of the cylinder block, and unscrew all the small (M6) bolts securing the main bearing ladder to the base of the cylinder block. Note the correct fitted depth of both the left- and right-hand crankshaft oil seals in the cylinder block/main bearing ladder.

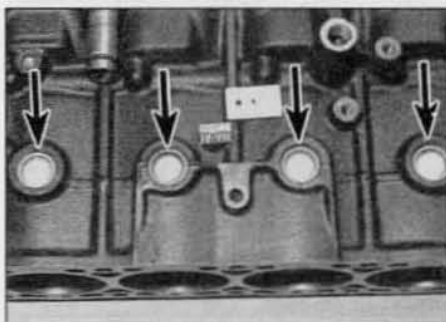

11.1 Cylinder block core plugs (arrowed)

- 5 Working in a diagonal sequence, evenly and progressively slacken the ten large (M11) main bearing ladder retaining bolts by a turn at a time. Once all the bolts are loose, remove them from the ladder.

- 6 With all the retaining bolts removed, carefully lift the main bearing ladder casting away from the base of the cylinder block. Recover the lower main bearing shells, and tape them to their respective locations in the casting. If the two locating dowels are a loose fit, remove them and store them with the casting for safe-keeping.

- 7 Lift out the crankshaft, and discard both the oil seals. Remove the oil pump drive chain from the end of the crankshaft. Where necessary, slide off the drive sprocket, and recover the Woodruff key.

- 8 Recover the upper main bearing shells, and store them along with the relevant lower bearing shell. Also recover the two thrustwashers (one fitted either side of No 2 main bearing) from the cylinder block.

**1.6 litre engines**

- 9 Unbolt and remove the crankshaft left- and right-hand oil seal housings from each end of the cylinder block, noting the correct fitted locations of the locating dowels. If the locating dowels are a loose fit, remove them and store them with the housings for safe-keeping.

- 10 Remove the oil pump drive chain, and slide the drive sprocket off the end of the crankshaft. Remove the Woodruff key, and store it with the sprocket for safe-keeping.

- 11 The main bearing caps should be numbered 1 to 5 from the transmission (flywheel) end of the engine. If not, mark them accordingly using a centre-punch or paint.

- 12 Unscrew and remove the main bearing cap retaining bolts, and withdraw the caps. Recover the lower main bearing shells, and tape them to their respective caps for safe-keeping.

- 13 Carefully lift out the crankshaft, taking care not to displace the upper main bearing shell.

- 14 Recover the upper bearing shells from the cylinder block, and tape them to their respective caps for safe-keeping. Remove the thrustwasher halves from the side of No 2 main bearing, and store them with the bearing cap.

**11 Cylinder block/crankcase - cleaning and inspection**

**Cleaning**

- 1 Remove all external components and electrical switches/sensors from the block. For complete cleaning, the core plugs should ideally be removed (see illustration). Drill a small hole in the plugs, then insert a self-tapping screw into the hole. Pull out the plugs

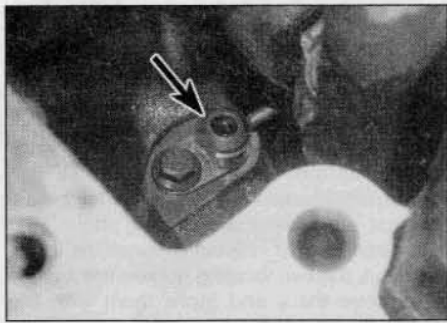

11.3 Piston oil jet spray tube (arrowed) in the cylinder block

by pulling on the screw with a pair of grips, or by using a slide hammer.

2 On aluminium block petrol engines with wet liners (1.4 litre), remove the liners – see paragraph 18.

3 Where applicable, undo the retaining bolts and remove the piston oil jet spray tubes (there is one for each piston) from inside the cylinder block (see illustration).

4 Scrape all traces of gasket from the cylinder block/crankcase, and from the main bearing ladder/caps (as applicable), taking care not to damage the gasket/sealing surfaces.

5 Remove all oil gallery plugs (where fitted). The plugs are usually very tight – they may have to be drilled out, and the holes retapped. Use new plugs when the engine is reassembled.

6 If any of the castings are extremely dirty, all should be steam-cleaned.

7 After the castings are returned, clean all oil holes and oil galleries one more time. Flush all internal passages with warm water until the water runs clear. Dry thoroughly, and apply a light film of oil to all mating surfaces, to prevent rusting. On cast-iron block engines, also oil the cylinder bores. If you have access to compressed air, use it to speed up the drying process, and to blow out all the oil holes and galleries.



**Warning:** Wear eye protection when using compressed air.

8 If the castings are not very dirty, you can do an adequate cleaning job with hot, soapy water and a stiff brush. Take plenty of time, and do a thorough job. Regardless of the cleaning method used, be sure to clean all oil holes and galleries very thoroughly, and to dry all components well. On cast-iron block engines, protect the cylinder bores as described above, to prevent rusting.

9 All threaded holes must be clean, to ensure accurate torque readings during reassembly. To clean the threads, run the correct-size tap into each of the holes to remove rust, corrosion, thread sealant or sludge, and to restore damaged threads (see illustration). If possible, use compressed air to clear the holes of debris produced by this operation.

10 Apply suitable sealant to the new oil

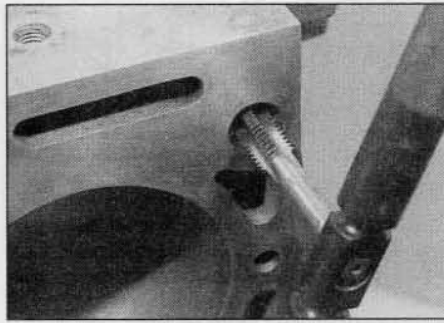

11.9 Use a suitable tap to clean the cylinder block threaded holes

gallery plugs, and insert them into the holes in the block. Tighten them securely. Also apply suitable sealant to new core plugs, and drive them into the block using a tube or socket.

11 Where applicable, clean the threads of the piston oil jet retaining bolts, and apply a drop of thread-locking compound (Peugeot/Citroën recommend Loctite Frenetanch) to each bolt threads. Refit the piston oil jet spray tubes to the cylinder block, and tighten the retaining bolts to the specified torque setting.

12 If the engine is not going to be reassembled right away, cover it with a large plastic bag to keep it clean; protect all mating surfaces and the cylinder bores as described above, to prevent rusting.

### Inspection

#### Cast-iron cylinder block

13 Visually check the castings for cracks and corrosion. Look for stripped threads in the threaded holes. If there has been any history of internal water leakage, it may be worthwhile having an engine overhaul specialist check the cylinder block/crankcase with special equipment. If defects are found, have them repaired if possible, or renew the assembly.

14 Check each cylinder bore for scuffing and scoring. Check for signs of a wear ridge at the top of the cylinder, indicating that the bore is excessively worn.

15 Accurate measuring of the cylinder bores requires specialised equipment and experience. We recommend having the bores

measured by an engine reconditioning specialist who will also be able to supply appropriate pistons (where possible) should a rebore be necessary.

16 If the cylinder bores and pistons are in reasonably good condition, and not worn beyond the specified limits, and if the piston-to-bore clearances can be maintained, then it will only be necessary to renew the piston rings. If this is the case, the cylinder bores must be honed to allow the new piston rings to bed in correctly and provide the best possible seal. An engine reconditioning specialist will carry out this work at moderate cost.

17 At the time of writing, it was not clear whether oversize pistons were available for all models. Consult your Peugeot/Citroën dealer or engine specialist for the latest information on piston availability. If oversize pistons are available (either from Peugeot/Citroën, or from another source), then it may be possible to have the cylinder bores rebored and fit the oversize pistons. If oversize pistons are not available, and the bores are worn, renewal of the block seems to be the only option.

#### Aluminium cylinder block

18 Remove the liner clamps (where used), then use a hardwood drift to tap out each liner from the inside of the cylinder block. When all the liners are released, tip the cylinder block/crankcase on its side and remove each liner from the top of the block. As each liner is removed, stick masking tape on its left-hand (transmission side) face, and write the cylinder number on the tape. No 1 cylinder is at the transmission (flywheel) end of the engine. Remove the sealing ring from the base of each liner, and discard (see illustrations).

19 Check each cylinder liner for scuffing and scoring. Check for signs of a wear ridge at the top of the liner, indicating that the bore is excessively worn.

20 Take the liners to an engine reconditioning specialist and have their bores measured to determine if renewal is necessary. If it is, the specialist will be able to advise you regarding piston/liner availability.

21 Prior to installing the liners, check the liner protrusion as follows. Thoroughly clean the mating surfaces of the liner and cylinder

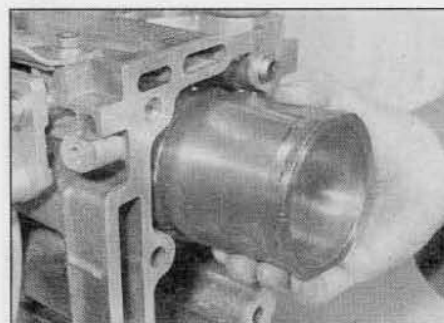

11.18a On aluminium block engines, remove each liner . . .

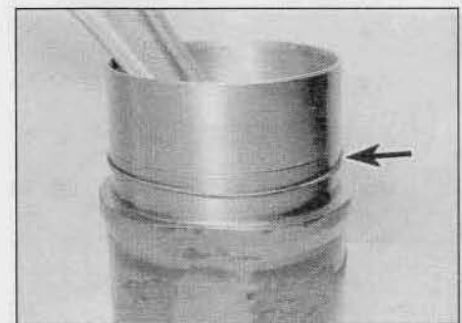

11.18b . . . and recover the bottom O-ring seal (arrowed)



block. Insert the liners into the block ensuring each one is correctly seated; if the original liners are being refitted, ensure the liners are fitted in their original locations. With all four liners correctly installed, use a dial gauge (or a straight-edge and feeler blade) to check that the protrusion of each liner above the upper surface of the cylinder block is within the limits given in the Specifications. The maximum difference between any two liners must not be exceeded. **Note:** *If new liners are being fitted, it is permissible to interchange them to bring the difference in protrusion within limits. Remember to keep each piston with its respective liner.* If liner protrusion is not within the specified limits, seek the advice of an engine reconditioning specialist before proceeding with the engine rebuild.

**22** Once the protrusions have been checked, remove the liners from the block and fit a new sealing ring carefully to the base of each liner. Lubricate the base of each liner with a smear of oil to aid installation.

**23** Insert each liner into the cylinder block, taking care not to damage the O-ring, and press it home as far as possible by hand. Using a hammer and a block of wood, tap each liner lightly but fully onto its locating shoulder. If the original liners are being refitted, use the marks made on removal to ensure that each is refitted the correct way round, and is inserted into its original bore.

**24** Wipe clean, then lightly oil all exposed liner surfaces, to prevent rusting. Where necessary, clamp the liners back in position.

## 12 Piston/connecting rod assembly - inspection



**1** Before the inspection process can begin, the piston/connecting rod assemblies must be cleaned, and the original piston rings removed from the pistons.

**2** Carefully expand the old rings over the top of the pistons. The use of two or three old feeler blades will be helpful in preventing the rings dropping into empty grooves (see illustration). Be careful not to scratch the piston with the ends of the ring. The rings are brittle, and will snap if they are spread too far. They are also very sharp - protect your hands and fingers. Note that the third ring incorporates an expander. Always remove the rings from the top of the piston. Keep each set of rings with its piston if the old rings are to be re-used.

**3** Scrape away all traces of carbon from the top of the piston. A hand-held wire brush (or a piece of fine emery cloth) can be used, once the majority of the deposits have been scraped away.

**4** Remove the carbon from the ring grooves in the piston, using an old ring. Break the ring

in half to do this (be careful not to cut your fingers - piston rings are sharp). Be careful to remove only the carbon deposits - do not remove any metal, and do not nick or scratch the sides of the ring grooves.

**5** Once the deposits have been removed, clean the piston/connecting rod assembly with paraffin or a suitable solvent, and dry thoroughly. Make sure that the oil return holes in the ring grooves are clear.

**6** If the pistons and cylinder bores are not damaged or worn excessively, and if the cylinder block does not need to be rebored (where possible), the original pistons can be refitted. Normal piston wear shows up as even vertical wear on the piston thrust surfaces, and slight looseness of the top ring in its groove. New piston rings should always be used when the engine is reassembled.

**7** Carefully inspect each piston for cracks around the skirt, around the gudgeon pin holes, and at the piston ring 'lands' (between the ring grooves).

**8** Look for scoring and scuffing on the piston skirt, holes in the piston crown, and burned areas at the edge of the crown. If the skirt is scored or scuffed, the engine may have been suffering from overheating, and/or abnormal combustion which caused excessively high operating temperatures. The cooling and lubrication systems should be checked thoroughly. Scorch marks on the sides of the pistons show that blow-by has occurred. A hole in the piston crown, or burned areas at the edge of the piston crown, indicates that abnormal combustion (pre-ignition, knocking, or detonation) has been occurring. If any of the above problems exist, the causes must be investigated and corrected, or the damage will occur again. The causes are likely to be attributable to a faulty injector or engine management system fault.

**9** Corrosion of the piston, in the form of pitting, indicates that coolant has been leaking into the combustion chamber and/or the crankcase. Again, the cause must be corrected, or the problem may persist in the rebuilt engine.

**10** On aluminium block engines with wet liners, it is not possible to renew the pistons separately; pistons are only supplied with piston rings and a liner, as a part of a matched assembly (see Section 11). On iron-block engines, pistons can be purchased from a Peugeot/Citroën dealer or engine reconditioning specialist.

**11** Examine each connecting rod carefully for signs of damage, such as cracks around the big-end and small-end bearings. Check that the rod is not bent or distorted. Damage is highly unlikely, unless the engine has been seized or badly overheated. Detailed checking of the connecting rod assembly can only be carried out by an engine specialist with the necessary equipment.

**12** The connecting rod big-end cap nuts must be renewed whenever they are disturbed. Although Peugeot/Citroën do not

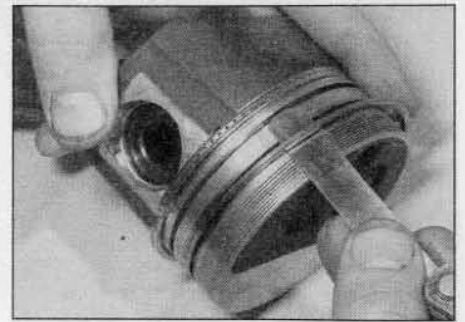

12.2 Remove the piston rings with the aid of a feeler gauge

specify that the bolts must also be renewed, it is recommended that the nuts and bolts are replaced as a complete set.

**13** The gudgeon pins are an interference fit in the connecting rod small-end bearing. Therefore, piston and/or connecting rod renewal should be entrusted to an engine reconditioning specialist, who will have the necessary tooling to remove and install the gudgeon pins.

## 13 Crankshaft - inspection



### Checking endfloat

**1** If the crankshaft endfloat is to be checked, this must be done when the crankshaft is still installed in the cylinder block/crankcase, but is free to move (see Section 10).

**2** Check the endfloat using a dial gauge in contact with the end of the crankshaft. Push the crankshaft fully one way, and then zero the gauge. Push the crankshaft fully the other way, and check the endfloat. The result can be compared with the specified amount, and will give an indication as to whether new thrustwashers are required (see illustration).

**3** If a dial gauge is not available, feeler blades can be used. First push the crankshaft fully towards the flywheel end of the engine, then use feeler blades to measure the gap between

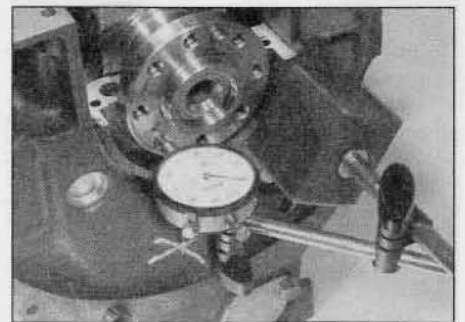

13.2 The crankshaft endfloat can be checked with a dial gauge . . .



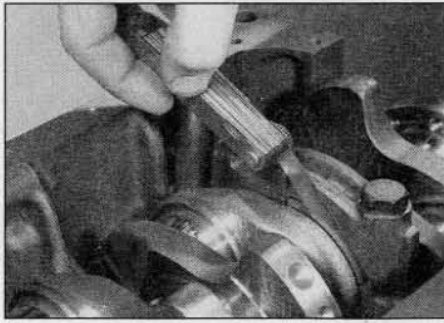

13.3 ... or with feeler gauges

the web of No 2 crankpin and the thrustwasher (see illustration).

**Inspection**

4 Clean the crankshaft using paraffin or a suitable solvent, and dry it, preferably with compressed air if available. Be sure to clean the oil holes with a pipe cleaner or similar probe, to ensure that they are not obstructed.



**Warning: Wear eye protection when using compressed air.**

5 Check the main and big-end bearing journals for uneven wear, scoring, pitting and cracking.

6 Big-end bearing wear is accompanied by distinct metallic knocking when the engine is running (particularly noticeable when the engine is pulling from low speed) and some loss of oil pressure.

7 Main bearing wear is accompanied by severe engine vibration and rumble – getting progressively worse as engine speed increases – and again by loss of oil pressure.

8 Check the bearing journal for roughness by running a finger lightly over the bearing surface. Any roughness (which will be accompanied by obvious bearing wear)

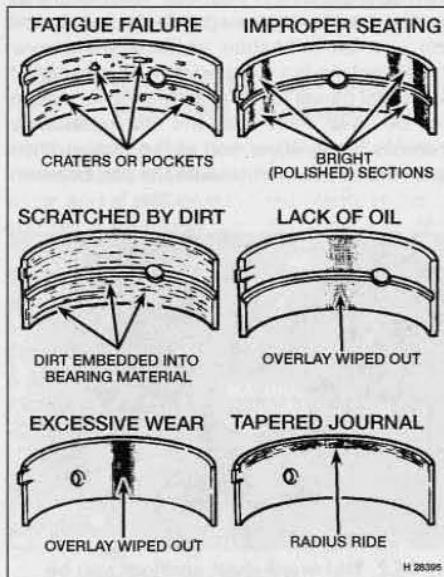

14.2 Typical bearing failures

indicates that the crankshaft requires regrounding (where possible) or renewal.

9 Check the oil seal contact surfaces at each end of the crankshaft for wear and damage. If the seal has worn a deep groove in the surface of the crankshaft, consult an engine overhaul specialist; repair may be possible, but otherwise a new crankshaft will be required.

10 Take the crankshaft to an engine reconditioning specialist to have it measured for journal wear. If excessive wear is evident, they will be able to advise you with regard to regrounding the crankshaft and supplying new bearing shells.

11 If the crankshaft has been reground, check for burrs around the crankshaft oil holes (the holes are usually chamfered, so burrs should not be a problem unless regrounding has been carried out carelessly). Remove any burrs with a fine file or scraper, and thoroughly clean the oil holes as described previously.

12 At the time of writing, it was not clear whether Peugeot/Citroën produce oversize bearing shells for all of these engines. On some engines, if the crankshaft journals have not already been reground, it may be possible to have the crankshaft reconditioned, and to fit oversize shells. If no oversize shells are available and the crankshaft has worn beyond the specified limits, it will have to be renewed. Consult your dealer or engine specialist for further information on parts availability.

**14 Main and big-end bearings – inspection**



1 Even though the main and big-end bearings should be renewed during the engine overhaul, the old bearings should be retained for close examination, as they may reveal valuable information about the condition of the engine. The bearing shells are graded by thickness, the grade of each shell being indicated by the colour code marked on it.

2 Bearing failure can occur due to lack of lubrication, the presence of dirt or other foreign particles, overloading the engine, or corrosion (see illustration). Regardless of the cause of bearing failure, the cause must be corrected (where applicable) before the engine is reassembled, to prevent it from happening again.

3 When examining the bearing shells, remove them from the cylinder block/crankcase, the connecting rods and the connecting rod big-end bearing caps. Lay them out on a clean surface in the same general position as their location in the engine. This will enable you to match any bearing problems with the corresponding crankshaft journal. Do not touch any shell's bearing surface with your fingers while checking it, or the delicate surface may be scratched.

4 Dirt and other foreign matter gets into the

engine in a variety of ways. It may be left in the engine during assembly, or it may pass through filters or the crankcase ventilation system. It may get into the oil, and from there into the bearings. Metal chips from machining operations and normal engine wear are often present. Abrasives are sometimes left in engine components after reconditioning, especially when parts are not thoroughly cleaned using the proper cleaning methods. Whatever the source, these foreign objects often end up embedded in the soft bearing material, and are easily recognised. Large particles will not embed in the bearing, and will score or gouge the bearing and journal. The best prevention for this cause of bearing failure is to clean all parts thoroughly, and keep everything spotlessly-clean during engine assembly. Frequent and regular engine oil and filter changes are also recommended.

5 Lack of lubrication (or lubrication breakdown) has a number of interrelated causes. Excessive heat (which thins the oil), overloading (which squeezes the oil from the bearing face) and oil leakage (from excessive bearing clearances, worn oil pump or high engine speeds) all contribute to lubrication breakdown. Blocked oil passages, which usually are the result of misaligned oil holes in a bearing shell, will also oil-starve a bearing, and destroy it. When lack of lubrication is the cause of bearing failure, the bearing material is wiped or extruded from the steel backing of the bearing. Temperatures may increase to the point where the steel backing turns blue from overheating.

6 Driving habits can have a definite effect on bearing life. Full-throttle, low-speed operation (labouring the engine) puts very high loads on bearings, tending to squeeze out the oil film. These loads cause the bearings to flex, which produces fine cracks in the bearing face (fatigue failure). Eventually, the bearing material will loosen in pieces, and tear away from the steel backing.

7 Short-distance driving leads to corrosion of bearings, because insufficient engine heat is produced to drive off the condensed water and corrosive gases. These products collect in the engine oil, forming acid and sludge. As the oil is carried to the engine bearings, the acid attacks and corrodes the bearing material.

8 Incorrect bearing installation during engine assembly will lead to bearing failure as well. Tight-fitting bearings leave insufficient bearing running clearance, and will result in oil starvation. Dirt or foreign particles trapped behind a bearing shell result in high spots on the bearing, which lead to failure.

9 Do not touch any shell's bearing surface with your fingers during reassembly; there is a risk of scratching the delicate surface, or of depositing particles of dirt on it.

10 As mentioned at the beginning of this Section, the bearing shells should be renewed as a matter of course during engine overhaul; to do otherwise is false economy.

## 15 Engine overhaul – reassembly sequence

**1** Before reassembly begins, ensure that all new parts have been obtained, and that all necessary tools are available. Read through the entire procedure to familiarise yourself with the work involved, and to ensure that all items necessary for reassembly of the engine are at hand. In addition to all normal tools and materials, thread-locking compound will be needed. A tube of suitable liquid sealant will also be required for the joint faces that are fitted without gaskets. It is recommended that Peugeot/Citroën's own product(s) are used, which are specially formulated for this purpose; the relevant product names are quoted in the text of each Section where they are required.

**2** In order to save time and avoid problems, engine reassembly can be carried out in the following order, referring to Part A of this Chapter unless otherwise stated:

- a) Crankshaft (See Section 17).
- b) Piston/connecting rod assemblies (See Section 18).
- c) Oil pump.
- d) Sump.
- e) Flywheel.
- f) Cylinder head.
- g) Timing belt tensioner pulley(s) and sprockets, and timing belt.
- h) Engine external components.

**3** At this stage, all engine components should be absolutely clean and dry, with all faults repaired. The components should be laid out (or in individual containers) on a completely clean work surface.

## 16 Piston rings – refitting



**1** Before fitting new piston rings, the ring end gaps must be checked as follows.

**2** Lay out the piston/connecting rod assemblies and the new piston ring sets, so that the ring sets will be matched with the same piston and cylinder during the end gap measurement and subsequent engine reassembly.

**3** Insert the top ring into the first cylinder, and push it down the bore using the top of the piston. This will ensure that the ring remains square with the cylinder walls. Position the ring near the bottom of the cylinder bore, at the lower limit of ring travel. Note that the top and second compression rings are different. The second ring can be identified by its taper; it also has a step on its lower surface.

**4** Measure the end gap using feeler blades.

**5** Repeat the procedure with the ring at the top of the cylinder bore, at the upper limit of its travel (see illustration), and compare the measurements with the figures given in the Specifications. If the end gaps are incorrect,

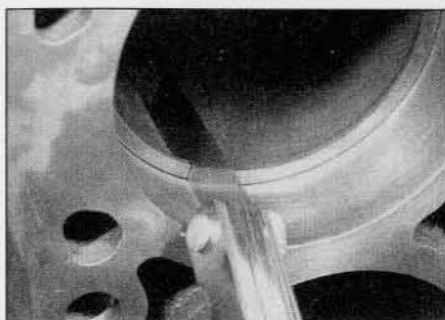

**16.5** Measure the piston rings end gaps with a feeler gauge

check that you have the correct rings for your engine and for the cylinder bore size.

**6** Repeat the checking procedure for each ring in the first cylinder, and then for the rings in the remaining cylinders. Remember to keep rings, pistons and cylinders matched up.

**7** Once the ring end gaps have been checked, the rings can be fitted to the pistons.

**8** Fit the oil control ring expander (where fitted) then install the ring.

**9** The second and top rings are different and can be identified from their cross-sections; the top ring is symmetrical whilst the second ring is tapered. Fit the second ring, ensuring its identification (TOP) marking is facing upwards, then install the top ring (see illustration). Arrange the oil control, second and top ring end gaps so they are equally spaced 120° apart. **Note:** Always follow any instructions supplied with the new piston ring sets – different manufacturers may specify different procedures. Do not mix up the top and second compression rings, as they have different cross-sections.

## 17 Crankshaft – refitting



### Selection of bearing shells

**1** Have the crankshaft inspected and measured by an engine reconditioning specialist. They will be able to carry out any regrinding/repairs, and supply suitable main and big-end bearing shells.

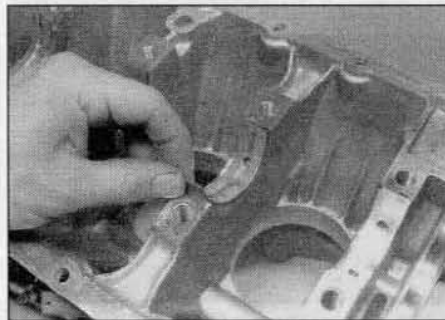

**17.5** Fit the grooved bearing shells to No 2 and 4 main bearings – 1.4 litre engines

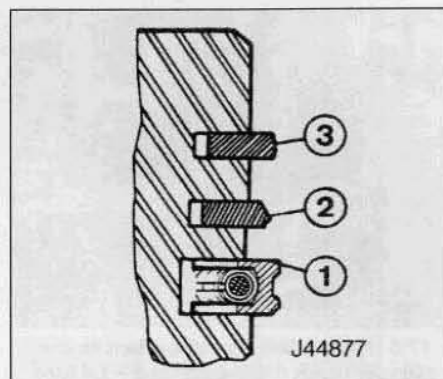

**16.9** Typical piston ring fitting diagram

- 1 Oil control ring
- 2 Second compression ring
- 3 Top compression ring

### Crankshaft refitting

**Note:** New main bearing cap/lower crankcase bolts must be used when refitting the crankshaft.

**2** Where applicable, ensure that the oil spray jets are fitted to the bearing locations in the cylinder block.

### 1.4 litre engines

**3** Using a little grease, stick the upper thrustwashers to each side of the No 2 main bearing upper location; ensure that the oilway grooves on each thrustwasher face outwards (away from the block).

**4** Clean the backs of the bearing shells, and the bearing locations in both the cylinder block/crankcase and the main bearing ladder/bearing caps.

**5** Press the bearing shells into their locations, ensuring that the tab on each shell engages in the notch in the cylinder block/crankcase or main bearing ladder/bearing cap. Take care not to touch any shell's bearing surface with your fingers. Note that the grooved bearing shells, both upper and lower, are fitted to Nos 2 and 4 main bearings (see illustration).

**6** Liberally lubricate each bearing shell in the cylinder block/crankcase with clean engine oil.

**7** Refit the Woodruff key, then slide on the oil pump drive sprocket, and locate the drive chain on the sprocket (see illustration).

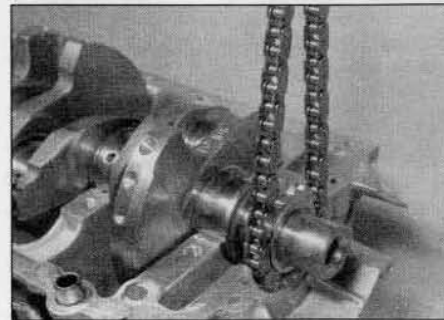

**17.7** Fit the oil pump drive chain and sprocket – 1.4 litre engines



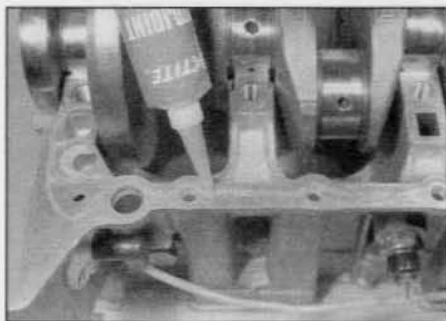

**17.8 Apply a thin film of sealant to the cylinder block mating surface – 1.4 litre engines**

Lower the crankshaft into position so that Nos 2 and 3 cylinder crankpins are at TDC; Nos 1 and 4 cylinder crankpins will be at BDC, ready for fitting No 1 piston. Check the crankshaft endfloat as described in Section 13.

**8** Thoroughly degrease the mating surfaces of the cylinder block/crankcase and the main bearing ladder. Apply a thin bead of suitable sealant to the cylinder block mating surface of the main bearing ladder casting, then spread to an even film (see illustration).

**9** Ensure the locating dowels are in position then lubricate the lower bearing shells with clean engine oil. Refit the main bearing ladder to the cylinder block, ensuring that the lower bearings remain correctly fitted.

**10** Install the main bearing ladder retaining bolts, and tighten them all by hand only. Working in a spiral pattern from the centre bolts outwards, evenly and progressively tighten the bolts to the specified Stage 1 torque wrench setting (see illustration). Once all the bolts have been tightened to the Stage 1 setting, working in the same sequence, angle-tighten the bolts through the specified Stage 2 angle using a socket and extension bar. It is recommended that an angle-measuring gauge is used during this stage of the tightening, to ensure accuracy. If a gauge is not available, use a dab of white paint to make alignment marks between the bolt head and casting prior to tightening; the marks can then be used to check that the bolt has been rotated sufficiently during tightening.

**11** Refit all the smaller bolts securing the

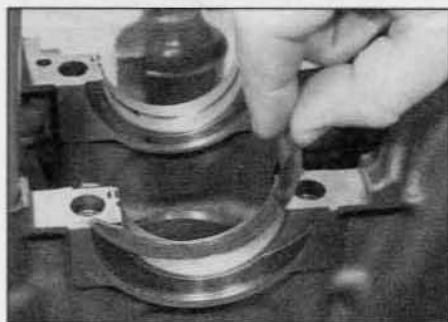

**17.17 Fit the thrustwashers to either side of the No 2 main bearing, with the oilway grooves facing outwards – 1.6 litre engines**



**17.10 Tighten the ten main bearing bolts to the specified torque – 1.4 litre engines**

main bearing ladder to the base of the cylinder block, and tighten them to the specified torque. Check that the crankshaft rotates freely.

**12** Refit the piston/connecting rod assemblies to the crankshaft as described in Section 18.

**13** Ensuring that the drive chain is correctly located on the sprocket, refit the oil pump and sump as described in Part A of this Chapter.

**14** Fit two new crankshaft oil seals as described in Part A of this Chapter.

**15** Refit the flywheel as described in Part A of this Chapter.

**16** Refit the cylinder head (where removed) as described in Part A. Also refit the crankshaft sprocket and timing belt (see Part A).

#### 1.6 litre engines

**17** Using a little grease, stick the upper thrustwashers to each side of the No 2 main bearing upper location. Ensure that the oilway grooves on each thrustwasher face outwards (away from the cylinder block) (see illustration).

**18** Place the bearing shells in their locations as described in paragraphs 4 and 5 (see illustration). If new shells are being fitted, ensure that all traces of protective grease are cleaned off using paraffin. Wipe dry the shells and connecting rods with a lint-free cloth. Liberally lubricate each bearing shell in the cylinder block/crankcase and cap with clean engine oil.

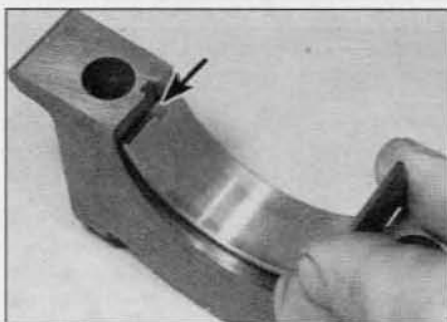

**17.18 Ensure the tab (arrowed) is located in the cut-out when fitting the bearing shells – 1.6 litre engines**

**19** Lower the crankshaft into position so that Nos 2 and 3 cylinder crankpins are at TDC; Nos 1 and 4 cylinder crankpins will be at BDC, ready for fitting No 1 piston. Check the crankshaft endfloat as described in Section 13.

**20** Lubricate the lower bearing shells in the main bearing caps with clean engine oil. Make sure that the locating lugs on the shells engage with the corresponding recesses in the caps.

**21** Fit the main bearing caps to their correct locations, ensuring that they are fitted the correct way round (the bearing shell lug recesses in the block and caps must be on the same side).

**22** Lightly lubricate the threads and the underside of the heads of the main bearing cap bolts with engine oil then refit the bolts. Working in a spiral sequence from the centre bolts outwards, tighten the main bearing cap bolts evenly and progressively to the specified Stage 1 torque wrench setting. Once all the bolts have been tightened to the Stage 1 setting, working in the same sequence, angle-tighten the bolts through the specified Stage 2 angle, using a socket and extension bar. It is recommended that an angle-measuring gauge is used during this stage of the tightening, to ensure accuracy. If a gauge is not available, use a dab of white paint to make alignment marks between the bolt head and casting prior to tightening; the marks can then be used to check that the bolt has been rotated sufficiently during tightening.

**23** Check that the crankshaft rotates freely.

**24** Refit the piston/connecting rod assemblies to the crankshaft as described in Section 18.

**25** Refit the Woodruff key to the crankshaft groove, and slide on the oil pump drive sprocket. Locate the drive chain on the sprocket.

**26** Ensure that the mating surfaces of right-hand (timing belt end) oil seal housing and cylinder block are clean and dry. Note the correct fitted depth of the oil seal then, using a large flat-bladed screwdriver, lever the seal out of the housing.

**27** Apply a smear of suitable sealant to the oil seal housing mating surface, and make sure that the locating dowels are in position. Slide the housing over the end of the crankshaft, and into position on the cylinder block. Tighten the housing retaining bolts securely.

**28** Repeat the operations in paragraphs 26 and 27, and fit the left-hand (flywheel end) oil seal housing.

**29** Fit new crankshaft oil seals as described in Part A of this Chapter.

**30** Ensuring that the chain is correctly located on the drive sprocket, refit the oil pump and sump as described in Part A of this Chapter.

**31** Refit the flywheel as described in Part A of this Chapter.

**32** Refit the cylinder head (where removed) and install the crankshaft sprocket and timing belt as described in the relevant Sections of Part A.



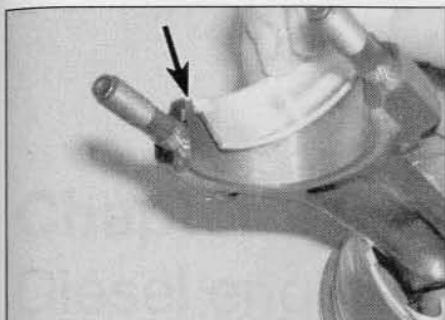

**18.3** Ensure the bearing shell tab (arrowed) locates correctly in the cut-out

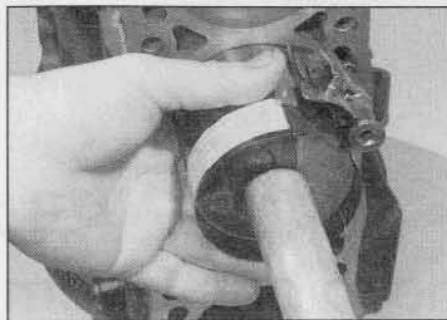

**18.7** Tap the piston into the bore using a hammer handle

**18 Piston/connecting rod assembly – refitting**



**Note:** New big-end cap nuts/bolts must be used on refitting.

**1** Note that the following procedure assumes that the cylinder liners (aluminium block engines) are in position in the cylinder block/crankcase as described in Section 11, and that the crankshaft and main bearing ladder/caps are in place.

**2** Clean the backs of the bearing shells, and the bearing locations in both the connecting rod and bearing cap.

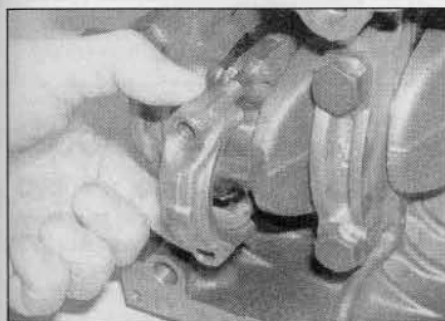

**18.8** Fit the big-end bearing cap, ensuring it is fitted the right way around, and screw on the new nuts

**3** Press the bearing shells into their locations, ensuring that the tab on each shell engages in the notch in the connecting rod and cap. Take care not to touch any shell's bearing surface with your fingers (**see illustration**).

**4** Lubricate the cylinder bores, the pistons, and piston rings, then lay out each piston/connecting rod assembly in its respective position.

**5** Start with assembly No 1. Make sure that the piston rings are still spaced as described in Section 16, then clamp them in position with a piston ring compressor.

**6** Insert the piston/connecting rod assembly into the top of cylinder/liner No 1, ensuring that the arrow on the piston crown is pointing towards the timing belt end of the engine.

**7** Once the piston is correctly positioned, using a block of wood or hammer handle against the piston crown, tap the assembly into the cylinder/liner until the piston crown is flush with the top of the cylinder/liner (**see illustration**).

**8** Ensure that the bearing shell is still correctly installed. Liberally lubricate the crankpin and both bearing shells. Taking care not to mark the cylinder/liner bores, pull the piston/connecting rod assembly down the bore and onto the crankpin. Refit the big-end bearing cap and fit the new nuts, tightening them finger-tight at first (**see illustration**). Note that the faces with the identification marks must match (which means that the

bearing shell locating tabs abut each other).

**9** Tighten the bearing cap retaining nuts evenly and progressively to the specified torque setting.

**10** Once the bearing cap retaining nuts have been correctly tightened, rotate the crankshaft. Check that it turns freely; some stiffness is to be expected if new components have been fitted, but there should be no signs of binding or tight spots.

**11** Refit the cylinder head and oil pump as described in Part A of this Chapter.

**19 Engine – initial start-up after overhaul**

**1** With the engine refitted in the vehicle, double-check the engine oil and coolant levels. Make a final check that everything has been reconnected, and that there are no tools or rags left in the engine compartment.

**2** Switch on the ignition and immediately turn the engine on the starter until the oil pressure warning light goes out.

**3** Pressurise the fuel system as described in Chapter 4A, then start the engine, noting that this may take a little longer than usual, due to the fuel system components having been disturbed.

**4** While the engine is idling, check for fuel, water and oil leaks. Don't be alarmed if there are some odd smells and smoke from parts getting hot and burning off oil deposits.

**5** Assuming all is well, keep the engine idling until hot water is felt circulating through the top hose, then switch off the engine.

**6** Allow the engine to cool then recheck the oil and coolant levels as described in *Weekly checks*, and top-up as necessary.

**7** If new pistons, rings or crankshaft bearings have been fitted, the engine must be treated as new, and run-in for the first 500 miles (800 km). Do not operate the engine at full-throttle, or allow it to labour at low engine speeds in any gear. It is recommended that the oil and filter be changed at the end of this period.

*[Faint, illegible text in the top-left column, likely bleed-through from the reverse side of the page.]*

*[Faint, illegible text in the middle-left column, likely bleed-through from the reverse side of the page.]*

*[Faint, illegible text in the bottom-left column, likely bleed-through from the reverse side of the page.]*

*[Faint, illegible text in the top-middle column, likely bleed-through from the reverse side of the page.]*

*[Faint, illegible text in the middle-middle column, likely bleed-through from the reverse side of the page.]*

*[Faint, illegible text in the bottom-middle column, likely bleed-through from the reverse side of the page.]*

*[Faint, illegible text in the top-right column, likely bleed-through from the reverse side of the page.]*

*[Faint, illegible text in the middle-right column, likely bleed-through from the reverse side of the page.]*

*[Faint, illegible text in the bottom-right column, likely bleed-through from the reverse side of the page.]*

## Chapter 2 Part E:

# Diesel engine removal and overhaul procedures

## Contents

	Section number		Section number
Crankshaft – inspection .....	14	Engine overhaul – general information .....	2
Crankshaft – refitting .....	18	Engine overhaul – reassembly sequence .....	16
Crankshaft – removal .....	11	Engine/transmission – removal and refitting .....	4
Cylinder block/crankcase – cleaning and inspection .....	12	Engine/transmission removal – methods and precautions .....	3
Cylinder head – dismantling .....	7	General information .....	1
Cylinder head – reassembly .....	9	Main and big-end bearings – inspection .....	15
Cylinder head (2.0 litre engines) – removal and refitting .....	5	Piston/connecting rod assembly – inspection .....	13
Cylinder head and valves – cleaning and inspection .....	8	Piston/connecting rod assembly – refitting .....	19
Engine – initial start-up after overhaul .....	20	Piston/connecting rod assembly – removal .....	10
Engine overhaul – dismantling sequence .....	6	Piston rings – refitting .....	17

## Degrees of difficulty

**Easy**, suitable for novice with little experience



**Fairly easy**, suitable for beginner with some experience



**Fairly difficult**, suitable for competent DIY mechanic



**Difficult**, suitable for experienced DIY mechanic



**Very difficult**, suitable for expert DIY or professional



## Specifications

### Cylinder head

Maximum gasket face distortion .....	0.03 mm
Cylinder head height:	
XUD series engines .....	157.4 to 157.7 mm
DW series engines:	
1.9 litre engines (from centre of camshaft to head mating surface) .....	139.95 to 140.25 mm
2.0 litre engines .....	133.0 mm
Swirl chamber protrusion – 1.8 and 1.9 litre engines only .....	0 to 0.03 mm

### Valves

Valve head diameter:	<b>Inlet</b>	<b>Exhaust</b>
1.8 and 1.9 litre engines .....	38.6 mm	33.0 mm
2.0 litre engines .....	35.6 mm	33.8 mm
Valve stem diameter:	<b>Inlet</b>	<b>Exhaust</b>
1.8 and 1.9 litre engines .....	7.96 to 7.99 mm	7.95 to 7.98 mm
2.0 litre engines .....	5.978 ± 0.007 mm	5.968 ± 0.007 mm
Overall length:	<b>Inlet</b>	<b>Exhaust</b>
1.8 and 1.9 litre engines .....	112.10 to 112.70 mm	111.55 to 112.15 mm
2.0 litre engines:		
Standard .....	107.18 mm	107.18 mm
Minimum .....	106.78 mm	106.78 mm

### Cylinder block

Cylinder bore diameter:	
1.8 litre engines .....	80.00 mm (nominal)
1.9 litre:	
XUD series engines .....	83.00 mm (nominal)
DW series engines .....	82.20 mm (nominal)
2.0 litre engines .....	85.00 mm (nominal)



**Pistons**

Piston diameter:	
1.8 litre engines	79.92 mm (nominal)
1.9 litre:	
XUD series engines	82.92 mm (nominal)
DW series engines	82.12 mm (nominal)
2.0 litre engines	84.21 mm (nominal)

Check with your Peugeot/Citroën dealer or engine specialist regarding piston oversizes

**Crankshaft**

Endfloat	0.07 to 0.32 mm	
Main bearing journal diameter:	<b>Standard</b>	<b>Undersize</b>
All engines	59.977 to 60.000 mm	59.677 to 59.700 mm
Big-end bearing journal diameter:	<b>Standard</b>	<b>Undersize</b>
All engines	49.984 to 50.000 mm	49.681 to 49.700 mm
Maximum bearing journal out-of-round	0.007 mm	
Main bearing running clearance*	0.025 to 0.050 mm	
Big-end bearing running clearance*	0.025 to 0.050 mm	

\* These are suggested figures, typical for this type of engine – no exact values are stated by the manufacturer.

**Piston rings**

End gaps:	
Top and second compression rings	0.20 to 0.40 mm
Oil control ring	0.25 to 0.50 mm

\* These are suggested figures, typical for this type of engine – no exact values are stated by the manufacturer.

**Torque wrench settings****1.8 and 1.9 litre (XUD series) engines**

Refer to Chapter 2B Specifications.

**1.9 and 2.0 litre (DW series) engines**

Refer to Chapter 2C Specifications.

**1 General information**

Included in this Part of Chapter 2 are details of removing the engine/transmission from the car and general overhaul procedures for the cylinder head, cylinder block/crankcase and all other engine internal components.

The information given ranges from advice concerning preparation for an overhaul and the purchase of new parts, to detailed step-by-step procedures covering removal, inspection, renovation and refitting of engine internal components.

After Section 5, all instructions are based on the assumption that the engine has been removed from the car. For information concerning in-car engine repair, as well as the removal and refitting of those external components necessary for full overhaul, refer to Part B or C of this Chapter, and to Section 6. Ignore any preliminary dismantling operations described in Part B or C that are no longer relevant once the engine has been removed from the car.

Apart from torque wrench settings, which are given at the beginning of Part B and C, all specifications relating to engine overhaul are at the beginning of this Part of Chapter 2.

**2 Engine overhaul – general information**

It is not always easy to determine when, or if, an engine should be completely overhauled, as a number of factors must be considered.

High mileage is not necessarily an indication that an overhaul is needed, while low mileage does not preclude the need for an overhaul. Frequency of servicing is probably the most important consideration. An engine which has had regular and frequent oil and filter changes, as well as other required maintenance, should give many thousands of miles of reliable service. Conversely, a neglected engine may require an overhaul very early in its life.

Excessive oil consumption is an indication that piston rings, valve seals and/or valve guides are in need of attention. Make sure that oil leaks are not responsible before deciding that the rings and/or guides are worn. Perform a compression or leakdown test, as described in Part B or C of this Chapter, to determine the likely cause of the problem.

Check the oil pressure with a gauge fitted in place of the oil pressure switch, and compare

it with that specified. If it is extremely low, the main and big-end bearings, and/or the oil pump, are probably worn out.

Loss of power, rough running, knocking or metallic engine noises, excessive valve gear noise, and high fuel consumption may also point to the need for an overhaul, especially if they are all present at the same time. If a complete service does not remedy the situation, major mechanical work is the only solution.

A full engine overhaul involves restoring all internal parts to the specification of a new engine. During a complete overhaul, the pistons and the piston rings are renewed, and the cylinder bores are reconditioned. New main and big-end bearings are generally fitted; if necessary, the crankshaft may be reground, to compensate for wear in the journals. The valves are also serviced as well, since they are usually in less-than-perfect condition at this point. Always pay careful attention to the condition of the oil pump when overhauling the engine, and renew it if there is any doubt as to its serviceability. The end result should be an as-new engine that will give many trouble-free miles.

Critical cooling system components such as the hoses, thermostat and water pump should be renewed when an engine is overhauled. The radiator should be checked

carefully, to ensure that it is not clogged or leaking. Also, it is a good idea to renew the oil pump whenever the engine is overhauled.

Before beginning the engine overhaul, read through the entire procedure, to familiarise yourself with the scope and requirements of the job. Check on the availability of parts and make sure that any necessary special tools and equipment are obtained in advance. Most work can be done with typical hand tools, although a number of precision measuring tools are required for inspecting parts to determine if they must be renewed.

The services provided by an engineering machine shop or engine reconditioning specialist will almost certainly be required, particularly if major repairs such as crankshaft regrinding or cylinder reboring are necessary. Apart from carrying out machining operations, these establishments will normally handle the inspection of parts, offer advice concerning reconditioning or renewal and supply new components such as pistons, piston rings and bearing shells. It is recommended that the establishment used is a member of the Federation of Engine Re-Manufacturers, or a similar society.

Always wait until the engine has been completely dismantled, and until all components (especially the cylinder block/crankcase and the crankshaft) have been inspected, before deciding what service and repair operations must be performed by an engineering works. The condition of these components will be the major factor to consider when determining whether to overhaul the original engine, or to buy a reconditioned unit. Do not, therefore, purchase parts or have overhaul work done on other components until they have been thoroughly inspected. As a general rule, time is the primary cost of an overhaul, so it does not pay to fit worn or sub-standard parts.

As a final note, to ensure maximum life and minimum trouble from a reconditioned engine, everything must be assembled with care, in a spotlessly-clean environment.

### 3 Engine/transmission removal – methods and precautions

If you have decided that the engine must be removed for overhaul or major repair work, several preliminary steps should be taken.

Locating a suitable place to work is extremely important. Adequate work space, along with storage space for the car, will be needed. If a workshop or garage is not available, at the very least, a flat, level, clean work surface is required.

Cleaning the engine compartment and engine/transmission before beginning the removal procedure will help keep tools clean and organised.

An engine hoist will also be necessary. Make sure the equipment is rated in excess of

the combined weight of the engine and transmission. Safety is of primary importance, considering the potential hazards involved in removing the engine/transmission from the car.

The help of an assistant is essential. Apart from the safety aspects involved, there are many instances when one person cannot simultaneously perform all of the operations required during engine/transmission removal.

Plan the operation ahead of time. Before starting work, arrange for the hire of or obtain all of the tools and equipment you will need. Some of the equipment necessary to perform engine/transmission removal and installation safely (in addition to an engine hoist) is as follows: a heavy duty trolley jack, complete sets of spanners and sockets as described in the rear of this manual, wooden blocks, and plenty of rags and cleaning solvent for mopping-up spilled oil, coolant and fuel. If the hoist must be hired, make sure that you arrange for it in advance, and perform all of the operations possible without it beforehand. This will save you money and time.

Plan for the car to be out of use for quite a while. An engineering machine shop or engine reconditioning specialist will be required to perform some of the work which cannot be accomplished without special equipment. These places often have a busy schedule, so it would be a good idea to consult them before removing the engine, in order to accurately estimate the amount of time required to rebuild or repair components that may need work.

During the engine/transmission removal procedure, it is advisable to make notes of the locations of all brackets, cable ties, earthing points, etc, as well as how the wiring harnesses, hoses and electrical connections are attached and routed around the engine and engine compartment. An effective way of doing this is to take a series of photographs of the various components before they are disconnected or removed; the resulting photographs will prove invaluable when the engine/transmission is refitted.

Always be extremely careful when removing and refitting the engine/transmission. Serious injury can result from careless actions. Plan ahead and take your time, and a job of this nature, although major, can be accomplished successfully.

The engine and transmission assembly is removed downwards from the engine compartment on all models described in this Chapter.

### 4 Engine/transmission – removal and refitting

**Note:** Such is the complexity of the power unit arrangement on these vehicles, and the variations that may be encountered according to model and optional equipment fitted, that the following should be regarded as a guide to

the work involved, rather than a step-by-step procedure. Where differences are encountered, or additional component disconnection or removal is necessary, make notes of the work involved as an aid to refitting.



**Warning:** It is essential to observe strict precautions when working on the fuel system components of the 2.0 litre engine. Before carrying out any of the following operations, refer to the special information given in Chapter 4C, Section 1.

### Removal

**Note:** The engine can be removed from the car only as a complete unit with the transmission; the two are then separated for overhaul.

1 Remove the battery, battery tray and mounting plate as described in see Chapter 5A.

2 Apply the handbrake, then jack up the front of the vehicle and support it on axle stands (see *Jacking and vehicle support*). Remove both front roadwheels.

3 On 1.9 litre (DW series) engines, release the fasteners from the right-hand side and top of the engine cover then lift off the cover, taking care not to lose its mounting rubbers. On 2.0 litre engines, turn the four plastic fasteners through 90° and lift off the engine cover

4 To improve access, remove the bonnet as described in Chapter 11.

5 Remove the air cleaner housing and intake ducting as described in Chapter 4B or 4C.

6 Drain the cooling system with reference to Chapter 1B.

7 Drain the transmission oil as described in Chapter 7. Refit the drain and filler plugs, and tighten them to their specified torque settings.

8 If the engine is to be dismantled, drain the engine oil and remove the oil filter as described in Chapter 1B. Clean and refit the drain plug, tightening it securely.

9 Remove both the front wheel arch liners. The liners are secured by various screws and clips under the wheel arch. Release all the fasteners, and remove liners from under the front wings.

10 Refer to Chapter 1B and remove the auxiliary drivebelt.

11 Refer to Chapter 8 and remove both front driveshafts.

12 Disconnect the radiator top and bottom hoses, the heater hoses at the engine compartment bulkhead, and the expansion tank hose. Remove the radiator as described in Chapter 3.

13 On models with air conditioning, refer to Chapter 3 and unbolt the compressor from the engine. **Do not** disconnect the refrigerant lines. Support or tie the compressor to one side.

14 On models with power steering, remove the power steering pump as described in Chapter 10. Release the power steering pipe from the retaining clips on the underside of the transmission.



15 On 1.8 and 1.9 litre (XUD series) engines, carry out the following operations with reference to Chapter 4B:

- Disconnect the fuel supply hose from the thermostat/fuel filter housing and the return hose from the fuel injection pump.
- Release the fuel hoses and priming pump from their retaining clips and move them clear of the engine.
- Disconnect the accelerator cable from the fuel injection pump.
- Disconnect the exhaust front pipe/catalytic converter from the exhaust manifold.

16 On 1.9 and 2.0 litre (DW series) engines, carry out the following operations with reference to Chapter 4C:

- At the connections above the fuel pump, disconnect the fuel supply and return hose quick-release fittings using a small screwdriver to release the locking clip. Suitably plug or cover the open unions to prevent dirt entry.
- Release the fuel hoses from their retaining clips and move them clear of the engine.
- Disconnect the accelerator cable from the fuel injection pump or accelerator pedal position sensor (as applicable).
- Disconnect the wiring connectors at the engine management ECU.
- Disconnect the catalytic converter from the exhaust manifold/turbocharger.

17 Disconnect the vacuum hoses and wiring connector at the EGR solenoid valve.

18 Unbolt the preheating system control unit located at the front of the engine compartment.

19 Open the engine compartment fuse/relay box and disconnect the engine related wiring connectors.

20 Trace the wiring harness back from the engine to the main harness connectors at the fuse/relay box, and/or at the bulkhead connection or front body panel connection. Release the locking rings by twisting them anti-clockwise and disconnect the connectors. Also trace the wiring connectors back to the transmission and disconnect all engine related wiring and earth leads in this area. Check that all the relevant connectors have been disconnected, and that the harness is released from all the clips or ties, so that it is free to be removed with the engine/transmission.

21 Disconnect the engine earth leads at the fusebox, under the left hand wheel arch and on the left-hand chassis member.

22 Disconnect the brake servo unit vacuum pipe from the vacuum pump, or at the quick-release connector on the pipe.

23 Disconnect the clutch cable from the release lever and transmission bracket as described in Chapter 6.

24 Disconnect the gearchange selector mechanism from the transmission as described in Chapter 7.

25 Remove the front subframe as described in Chapter 10.

26 Using a hoist attached to the lifting eyes on the cylinder head, take the weight of the engine and transmission.

27 Remove the right-hand and left-hand engine mountings and support brackets as described in Chapter 2B or 2C.

28 Make a final check to ensure all wiring, hoses and brackets that would prevent the removal of the assembly have been disconnected.

29 Carefully lower the engine/transmission from the engine compartment taking care not to damage the surrounding components. Ideally lower the unit onto a low trolley so that it may be withdrawn from under the car. Disconnect the hoist from the engine/transmission assembly.

### Separation

30 With the engine/transmission assembly removed, support the assembly on suitable blocks of wood on a workbench (or failing that, on a clean area of the workshop floor).

31 Undo the retaining bolts, and remove the flywheel lower cover plate from the transmission.

32 Slacken and remove the retaining bolts, and remove the starter motor from the transmission.

33 Disconnect any remaining wiring connectors at the transmission, then move the main engine wiring harness to one side.

34 Ensure that both engine and transmission are adequately supported, then slacken and remove the remaining bolts securing the transmission housing to the engine. Note the correct fitted positions of each bolt (and the relevant brackets) as they are removed, to use as a reference on refitting.

35 Carefully withdraw the transmission from the engine, ensuring that the weight of the transmission is not allowed to hang on the input shaft while it is engaged with the clutch friction disc.

36 If they are loose, remove the locating dowels from the engine or transmission, and keep them in a safe place.

### Refitting

37 If the engine and transmission have not been separated, perform the operations described below from paragraph 44 onwards.

38 Apply a smear of high melting-point grease (Peugeot/Citroën recommend the use of Molykote BR2 plus) to the splines of the transmission input shaft. Do not apply too much, otherwise there is a possibility of the grease contaminating the clutch friction disc.

39 Ensure that the locating dowels are correctly positioned in the engine or transmission.

40 Carefully offer the transmission to the engine, until the locating dowels are engaged. Ensure that the weight of the transmission is not allowed to hang on the input shaft as it is engaged with the clutch friction disc.

41 Refit the transmission housing-to-engine

bolts, ensuring that all the necessary brackets are correctly positioned, and tighten them to the specified torque.

42 Refit the starter motor, and securely tighten its retaining bolts.

43 Refit the lower flywheel cover plate to the transmission, and securely tighten the bolts.

44 Position the engine/transmission assembly ready for installation, then reconnect the hoist and lifting tackle. With the aid of an assistant, locate the assembly into the engine compartment, using the same procedure as for removal.

45 Refit the right-hand and left-hand engine mountings and support brackets as described in Chapter 2B or 2C.

46 Remove the hoist from the engine.

47 Refit the front subframe as described in Chapter 10.

48 The remainder of the refitting procedure is a direct reversal of the removal sequence, with reference to the relevant chapters and noting the following points:

- Ensure that the wiring loom is correctly routed and retained by all the relevant retaining clips; all connectors should be correctly and securely reconnected.
- Ensure that all coolant hoses are correctly reconnected, and securely retained by their retaining clips.
- Refill the engine and transmission with the correct quantity and type of lubricant, as described in Chapters 1B and 7.
- Refill the cooling system as described in Chapter 1B.
- Prime the fuel system as described in Chapter 4B.
- Bleed the power steering system as described in Chapter 10.

### 5 Cylinder head (2.0 litre engines) – removal and refitting



**Note:** Due to the limited access at the rear of the engine, it is impossible to remove the cylinder head with the engine in the car unless considerable additional dismantling is carried out first (eg, removal of the front suspension subframe and related components). The following information describes the cylinder head removal and refitting procedure with the engine/transmission removed from the car.

### Removal

1 Remove the engine/transmission assembly as described in Section 4.

2 Remove the timing belt as described in Chapter 2C.

3 Carry out the following operations as described in Chapter 4C:

- Remove the exhaust manifold and turbocharger.
- Remove the inlet manifold.
- Remove the fuel system accumulator rail.



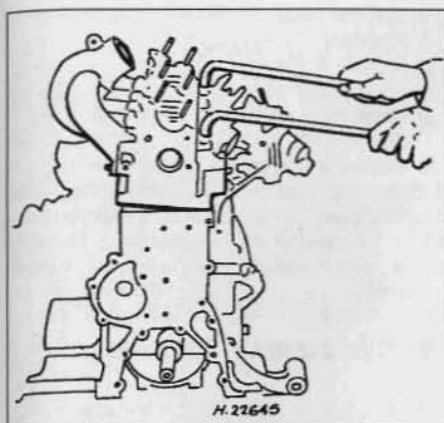

5.14 Free the cylinder head using angled rods

4 Undo the three bolts and remove the right-hand engine mounting upper bracket from the engine bracket. Undo the bolts securing the engine bracket to the cylinder head and block and remove the bracket.

5 Remove the braking system vacuum pump as described in Chapter 9.

6 Disconnect the wiring connectors and coolant hoses at the thermostat housing on the left-hand end of the cylinder head.

7 Undo the bolts and release the wiring harness guide from the thermostat housing.

8 Undo the retaining nuts and bolts and remove the fuel injector wiring harness guide left-hand support bracket.

9 Undo the mounting bolt and release the dipstick tube from the cylinder head.

10 Move all the adjacent components clear, then undo the three bolts and two nuts securing the thermostat housing to the cylinder head. Lift off the hose and cable support bracket, then withdraw the thermostat housing. Recover the housing gasket.

11 Remove the cylinder head cover as described in Chapter 2C.

12 Progressively slacken the cylinder head bolts, in the reverse order to that in illustration 5.29.

13 When all the bolts are loose, unscrew them fully and remove them from the cylinder head.

14 Release the cylinder head from the cylinder block and location dowels by rocking it. The Peugeot/Citroën tool for doing this consists simply of two metal rods with 90-degree angled ends (see illustration). Do not prise between the mating faces of the cylinder head and block, as this may damage the gasket faces.

15 Lift the cylinder head from the block, and recover the gasket.

### Preparation for refitting

16 The mating faces of the cylinder head and cylinder block must be perfectly clean before refitting the head. Peugeot/Citroën recommend the use of a scouring agent for this purpose, but acceptable results can be achieved by using a hard plastic or wood scraper to remove all traces of gasket and carbon. The same method can be used to clean the piston crowns. Take particular care to avoid scoring or gouging the cylinder head/cylinder block mating surfaces during the cleaning operations, as aluminium alloy is easily damaged. Make sure that the carbon is not allowed to enter the oil and water passages – this is particularly important for the lubrication system, as carbon could block the oil supply to the engine's components. Using adhesive tape and paper, seal the water, oil and bolt holes in the cylinder block. To prevent carbon entering the gap between the pistons and bores, smear a little grease in the gap. After cleaning each piston, use a small brush to remove all traces of grease and carbon from the gap, then wipe away the remainder with a clean rag.

17 Check the mating surfaces of the cylinder block and the cylinder head for nicks, deep scratches and other damage. If slight, they may be removed carefully with a file, but if excessive, machining may be the only alternative to renewal. If warpage of the cylinder head gasket surface is suspected, use a straight-edge to check it for distortion. Refer to Section 8 if necessary.

18 Thoroughly clean the threads of the cylinder head bolt holes in the cylinder block. Ensure that the bolts run freely in their threads, and that all traces of oil and water are removed from each bolt hole.

### Gasket selection

19 Turn the crankshaft until pistons 1 and 4 are at TDC. Position a dial test indicator (dial gauge) on the cylinder block, and zero it on the block face. Transfer the probe to the edge of No 1 piston, then slowly turn the crankshaft back-and-forth past TDC, noting the highest reading on the indicator. Record this reading.

20 Repeat this measurement procedure on No 4 piston, then turn the crankshaft half a turn (180°) and repeat the procedure on Nos 2 and 3 pistons (see illustration).

21 If a dial test indicator is not available, piston protrusion may be measured using a straight-edge and feeler blades or vernier callipers. However, this is much less accurate, and cannot therefore be recommended.

22 Note down the greatest piston protrusion measurement, and use this to determine the correct cylinder head gasket from the following table. The series of up to five notches on the side of the gasket are used for thickness identification (see illustration).

Piston protrusion	Gasket identification
0.470 to 0.605 mm	1 notch
0.605 to 0.655 mm	2 notches
0.655 to 0.705 mm	3 notches
0.705 to 0.755 mm	4 notches
0.755 to 0.830 mm	5 notches

### Cylinder head bolt examination

23 Carefully examine the cylinder head bolts for signs of damage to the threads or head, and for any sign of corrosion. If the bolts are in a satisfactory condition, measure the length of each bolt from the underside of the head, to the end of the shank. The bolts may be re-used providing that the measured length does not exceed 133.3 mm. **Note:** Considering the stress to which the cylinder head bolts are subjected, it is highly recommended that they are all renewed, regardless of their apparent condition.

### Refitting

24 Turn the crankshaft clockwise (viewed from the timing belt end) until Nos 1 and 4 pistons pass bottom dead centre (BDC) and begin to rise, then position them halfway up their bores. Nos 2 and 3 pistons will also be at their midway positions, but descending their bores.

25 Make sure that the locating dowels are in place, then fit the correct gasket the right way round on the cylinder block, with the identification notches toward the fuel pump side of the engine.

26 Lower the cylinder head onto the block.

27 Apply a smear of grease to the threads, and to the underside of the heads, of the cylinder head bolts. Peugeot/Citroën recommend the use of Molykote G Rapid Plus.

28 Carefully enter each bolt into its relevant hole (do not drop it in) and screw it in finger-tight.

29 Working progressively and in sequence, tighten the cylinder head bolts to their Stage 1

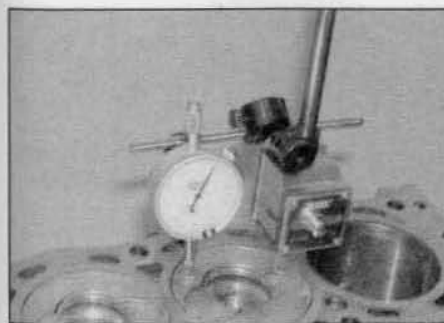

5.20 Measure the piston protrusion using a DTI gauge

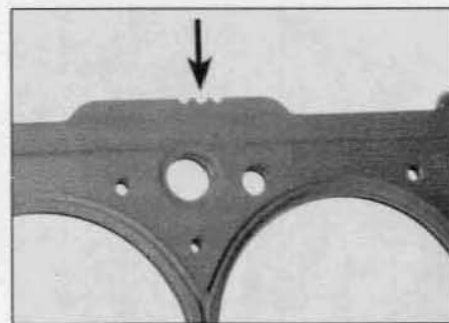

5.22 Cylinder head gasket thickness identification notches (arrowed)

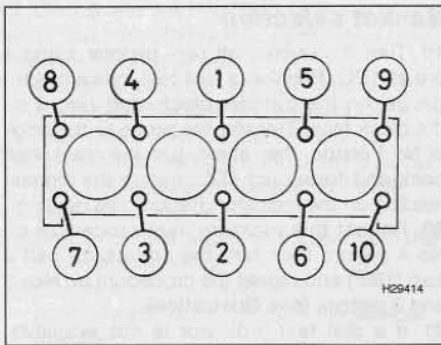

7.29 Cylinder head bolt tightening sequence

torque setting, using a torque wrench and suitable socket (see illustration).

**30** Once all the bolts have been tightened to their Stage 1 torque setting, working again in the specified sequence, tighten each bolt to the specified Stage 2 setting. Finally, angle-tighten the bolts through the specified Stage 3 angle. It is recommended that an angle-measuring gauge is used during this stage of tightening, to ensure accuracy.

**31** Refit the cylinder head cover as described in Chapter 2C.

**32** Ensure that the mating face of the cylinder head and thermostat housing are clean then refit the housing using a new gasket. Refit the hose and cable support bracket and the thermostat housing retaining nuts and bolts. Tighten the nuts and bolts securely.

**33** Refit and tighten the dipstick tube retaining bolt.

**34** Refit the wiring harness guide support brackets.

**35** Reconnect the coolant hoses to the thermostat housing.

**36** Refit the timing belt as described in Chapter 2C.

**37** Refit the accumulator rail, inlet manifold, and the exhaust manifold and turbocharger, in strict accordance with the procedures described in Chapter 4C.

**38** Refit the braking system vacuum pump as described in Chapter 9.

**39** Refit the right-hand engine mounting components with reference to Chapter 2C.

**40** Refit the engine/transmission assembly as described in Section 4.

## 6 Engine overhaul – dismantling sequence

**1** It is much easier to dismantle and work on the engine if it is mounted on a portable engine stand. These stands can often be hired from a tool hire shop. Before the engine is mounted on a stand, the flywheel should be removed, so that the stand bolts can be tightened into the end of the cylinder block/crankcase.

**2** If a stand is not available, it is possible to dismantle the engine with it blocked up on a sturdy workbench, or on the floor. Be extra careful not to tip or drop the engine when working without a stand.

**3** If you are going to obtain a reconditioned engine, all the external components must be removed first, to be transferred to the new engine (just as they will if you are doing a complete engine overhaul yourself). These components include the following:

- Ancillary unit mounting brackets (oil filter, starter, alternator, power steering pump, etc).
- Fuel filter/thermostat housing (Chapter 3).
- Dipstick tube/sensor.
- All electrical switches and sensors.
- Inlet and exhaust manifolds – where applicable (Chapter 4B or 4C).
- Flywheel (Part B or C of this Chapter).

**Note:** When removing the external components from the engine, pay close attention to details that may be helpful or important during refitting. Note the fitted position of gaskets, seals, spacers, pins, washers, bolts, and other small items.

**4** If you are obtaining a 'short' engine (which consists of the engine cylinder block/crankcase, crankshaft, pistons and connecting rods all assembled), then the cylinder head, sump, oil pump, and timing belt will have to be removed also.

**5** If you are planning a complete overhaul, the engine can be dismantled, and the internal components removed, in the order given below, referring to Part B or C of this Chapter unless otherwise stated.

- Inlet and exhaust manifolds – where applicable (Chapter 4B or 4C).
- Timing belts, sprockets and tensioner(s).

- Cylinder head.
- Flywheel.
- Sump.
- Oil pump.
- Piston/connecting rod assemblies (Section 10).
- Crankshaft (Section 11).

**6** Before beginning the dismantling and overhaul procedures, make sure that you have all of the correct tools necessary. Refer to *Tools and working facilities* for further information.

## 7 Cylinder head – dismantling

**Note:** New and reconditioned cylinder heads are available from the manufacturer, and from engine overhaul specialists. Some specialist tools are required for dismantling and inspection, and new components may not be readily available. It may therefore be more practical and economical for the home mechanic to purchase a reconditioned head, rather than dismantle, inspect and recondition the original head.

**1** Remove the cylinder head as described in Part B or C of this Chapter, or in Section 5 of this Part (as applicable).

**2** If not already done, remove the inlet and exhaust manifolds with reference to the relevant Part of Chapter 4.

**3** Remove the camshaft(s), followers and shims, or hydraulic tappets (as applicable) as described in Part B or C of this Chapter.

**4** Remove the glow plugs as described in Chapter 5C and the injectors as described in Chapter 4B or 4C.

**5** Using a valve spring compressor, compress each valve spring in turn until the split collets can be removed. Release the compressor, and lift off the spring retainer and spring. Using a pair of pliers, carefully extract the valve stem oil seal from the top of the guide, then lift out the spring seat (see illustrations).

**6** If, when the valve spring compressor is screwed down, the spring retainer refuses to free and expose the split collets, gently tap the top of the tool, directly over the retainer, with a light hammer. This will free the retainer.

**7** Withdraw the valve through the combustion chamber.

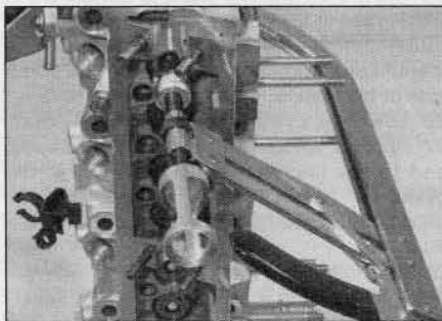

7.5a Compress the valve spring using a spring compressor . . .

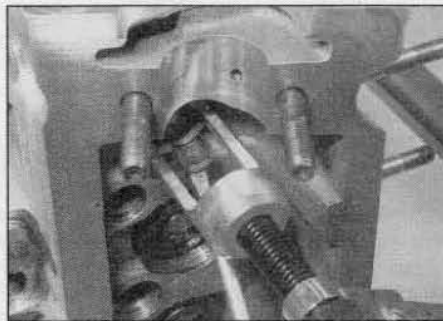

7.5b . . . then extract the collets and release the spring compressor

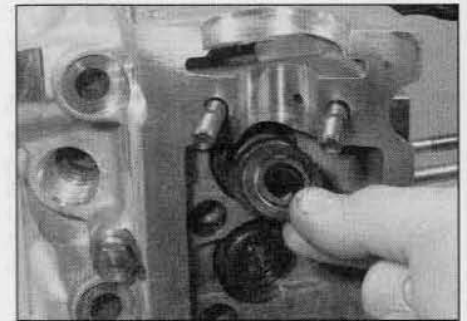

7.5c Remove the spring retainer . . .





7.5d ... followed by the valve spring



7.5e Remove the valve stem oil seal using a pair of pliers ...

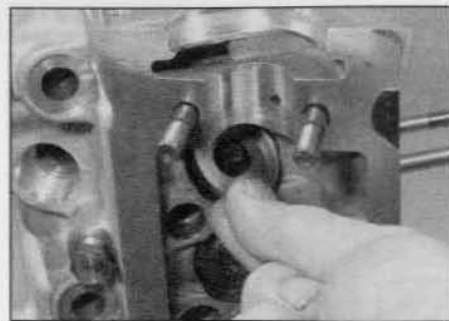

7.5f ... then lift out the spring seat

8 It is essential that each valve is stored together with its collets, retainer, spring, and spring seat. The valves should also be kept in their correct sequence, unless they are so badly worn that they are to be renewed. If they are going to be kept and used again, place each valve assembly in a labelled polythene bag or similar small container (see illustration). Note that No 1 valve is nearest to the transmission (flywheel) end of the engine.

### 8 Cylinder head and valves – cleaning and inspection



1 Thorough cleaning of the cylinder head and valve components, followed by a detailed inspection, will enable you to decide how much valve service work must be carried out during the engine overhaul.

**Note:** If the engine has been severely overheated, it is best to assume that the cylinder head is warped – check carefully for signs of this.

#### Cleaning

2 Scrape away all traces of old gasket material from the cylinder head.

3 Scrape away the carbon from the combustion chambers and ports, then wash the cylinder head thoroughly with paraffin or a suitable solvent.

4 Scrape off any heavy carbon deposits that may have formed on the valves, then use a power-operated wire brush to remove deposits from the valve heads and stems.



7.8 Place each valve and its associated components in a labelled polythene bag

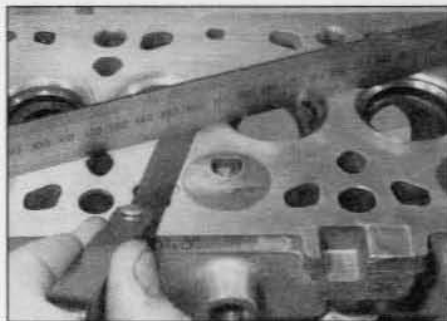

8.6 Checking the cylinder head gasket surface for distortion

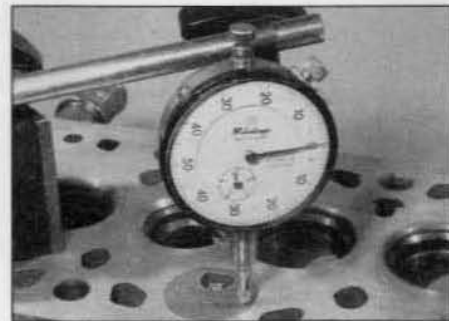

8.10 Checking a swirl chamber protrusion – 1.8 and 1.9 litre engines

#### Inspection

**Note:** Be sure to perform all the following inspection procedures before concluding that the services of a machine shop or engine overhaul specialist are required. Make a list of all items that require attention.

#### Cylinder head

5 Inspect the head very carefully for cracks, evidence of coolant leakage, and other damage. If cracks are found, a new cylinder head should be obtained.

6 Use a straight-edge and feeler blade to check that the cylinder head gasket surface is not distorted (see illustration). If it is, it may be possible to have it machined, provided that the cylinder head is not reduced to less than the specified height.

**Note:** It may be necessary to recut the valve seats if the cylinder head is machined. This is necessary in order to maintain the correct dimensions between the valve heads, valve guides and cylinder head gasket face.

7 Examine the valve seats in each of the combustion chambers. If they are severely pitted, cracked, or burned, they will need to be renewed or recut by an engine overhaul specialist. If they are only slightly pitted, this can be removed by grinding-in the valve heads and seats with fine valve-grinding compound, as described below.

8 Check the valve guides for wear by inserting the relevant valve, and checking for side-to-side motion of the valve. A very small amount of movement is acceptable. If the movement seems excessive, remove the

valve. Measure the valve stem diameter (see below), and renew the valve if it is worn. If the valve stem is not worn, the wear must be in the valve guide, and the guide must be renewed. The renewal of valve guides is best carried out by a Peugeot/Citroën dealer or engine overhaul specialist, who will have the necessary tools available.

9 If renewing the valve guides, the valve seats should be recut or reground only after the guides have been fitted.

10 On 1.8 and 1.9 litre engines, inspect the swirl chambers for burning or damage such as cracking. Small cracks in the chambers are acceptable; renewal of the chambers will only be required if chamber tracts are badly burned and disfigured, or if they are no longer a tight fit in the cylinder head. If there is any doubt as to the swirl chamber condition, seek the advice of a Peugeot/Citroën dealer or a suitable repairer who specialises in diesel engines. Swirl chamber renewal should be entrusted to a specialist. Using a dial test indicator, check that the swirl chamber protrusion is within the limits given in the Specifications (see illustration). Zero the dial test indicator on the gasket surface of the cylinder head, then measure the protrusion of the swirl chamber. If the protrusion is not within the specified limits, the advice of a Peugeot/Citroën dealer or suitable repairer who specialises in diesel engines should be sought.

#### Valves

11 Examine the head of each valve for pitting, burning, cracks, and general wear.



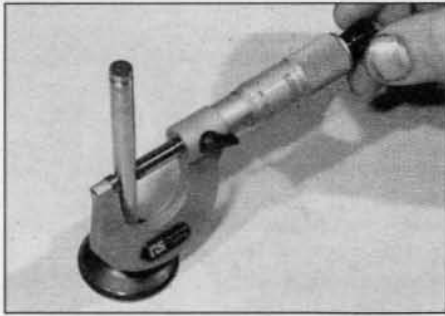

8.12 Measuring a valve stem diameter

Check the valve stem for scoring and wear ridges. Rotate the valve, and check for any obvious indication that it is bent. Look for pits or excessive wear on the tip of each valve stem. Renew any valve that shows any such signs of wear or damage.

12 If the valve appears satisfactory at this stage, measure the valve stem diameter at several points using a micrometer (see illustration). Any significant difference in the readings obtained indicates wear of the valve stem. Should any of these conditions be apparent, the valve(s) must be renewed.

13 If the valves are in satisfactory condition, they should be ground (lapped) into their respective seats, to ensure a smooth, gas-tight seal. If the seat is only lightly pitted, or if it has been recut, fine grinding compound only should be used to produce the required finish. Coarse valve-grinding compound should not be used, unless a seat is badly burned or deeply pitted. If this is the case, the cylinder head and valves should be inspected by an expert, to decide whether seat recutting, or even the renewal of the valve or seat insert (where possible) is required.

14 Valve grinding is carried out as follows. Place the head upside-down on a bench.

15 Smear a trace of (the appropriate grade of) valve-grinding compound on the seat face, and press a suction grinding tool onto the valve head (see illustration). With a semi-rotary action, grind the valve head to its seat, lifting the valve occasionally to redistribute the grinding compound. A light spring placed under the valve head will greatly ease this operation.

16 If coarse grinding compound is being used, work only until a dull, matt even surface

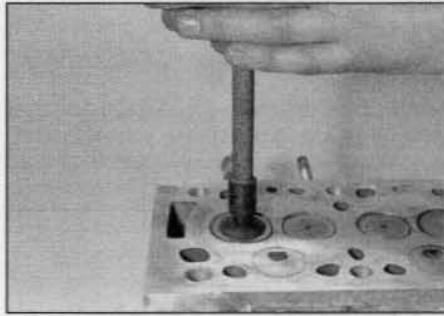

8.15 Grinding-in a valve

is produced on both the valve seat and the valve, then wipe off the used compound, and repeat the process with fine compound. When a smooth unbroken ring of light grey matt finish is produced on both the valve and seat, the grinding operation is complete. Do not grind-in the valves any further than absolutely necessary, or the seat will be prematurely sunk into the cylinder head.

17 When all the valves have been ground-in, carefully wash off all traces of grinding compound using paraffin or a suitable solvent, before reassembling the cylinder head.

**Valve components**

18 Examine the valve springs for signs of damage and discoloration. No minimum free length is specified by Peugeot/Citroën, so the only way of judging valve spring wear is by comparison with a new component.

19 Stand each spring on a flat surface, and check it for squareness. If any of the springs are damaged, distorted or have lost their tension, obtain a complete new set of springs. It is normal to fit new springs as a matter of course if a major overhaul is being carried out.

20 Renew the valve stem oil seals regardless of their apparent condition.

**9 Cylinder head – reassembly**

1 Lubricate the stems of the valves, and insert the valves into their original locations (see illustration). If new valves are being fitted, insert them into the locations to which they have been ground.

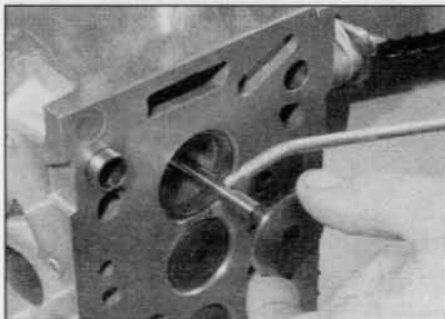

9.1 Lubricate the valve stems prior to refitting

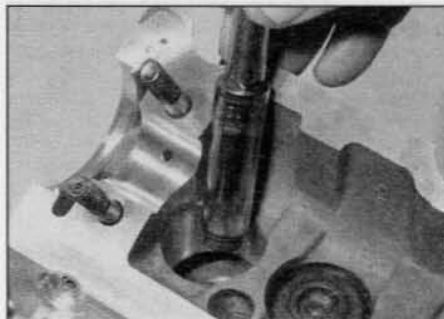

9.2 Fitting a valve stem oil seal using a socket

2 Refit the spring seat then, working on the first valve, dip the new valve stem seal in fresh engine oil. Carefully locate it over the valve and onto the guide. Take care not to damage the seal as it is passed over the valve stem. Use a suitable socket or tube to press the seal firmly onto the guide (see illustration).

3 Locate the valve spring on top of its seat, then refit the spring retainer.

4 Compress the valve spring, and locate the split collets in the recess in the valve stem. Release the compressor, then repeat the procedure on the remaining valves.



*Use a little dab of grease to hold the collets in position on the valve stem while the spring compressor is released.*

5 With all the valves installed, place the cylinder head flat on the bench and, using a hammer and interposed block of wood, tap the end of each valve stem to settle the components.

6 Refit the camshaft(s), followers and shims, or hydraulic tappets (as applicable) as described in Part B or C of this Chapter.

7 The cylinder head can then be refitted as described in Part B or C of this Chapter, or in Section 5 of this Part (as applicable).

**10 Piston/connecting rod assembly – removal**



1 Remove the cylinder head, sump and oil pump as described in Part B or C of this Chapter, or in Section 5 of this Part (as applicable).

2 If there is a pronounced wear ridge at the top of any bore, it may be necessary to remove it with a scraper or ridge reamer, to avoid piston damage during removal. Such a ridge indicates excess bore wear.

3 Using a hammer and centre-punch, paint or similar, mark each connecting rod and big-end bearing cap with its respective cylinder number on the flat machined surface provided; if the engine has been dismantled before, note carefully any identifying marks made previously (see illustration). Note that

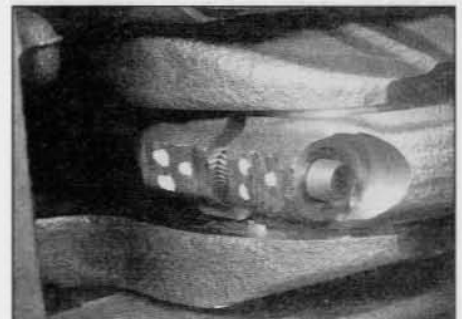

10.3 Connecting rod and big-end bearing cap identification marks (No 3 shown)

No 1 cylinder is at the transmission (flywheel) end of the engine.

4 Turn the crankshaft to bring pistons 1 and 4 to BDC (bottom dead centre).

5 Unscrew the nuts from No 1 piston big-end bearing cap. Take off the cap, and recover the bottom half bearing shell (see illustration). If the bearing shells are to be re-used, tape the cap and the shell together.

6 To prevent the possibility of damage to the crankshaft bearing journals, tape over the connecting rod stud threads (see illustration).

7 Using a hammer handle, push the piston up through the bore, and remove it from the top of the cylinder block. Recover the bearing shell, and tape it to the connecting rod for safe-keeping.

8 Loosely refit the big-end cap to the connecting rod, and secure with the nuts – this will help to keep the components in their correct order.

9 Remove No 4 assembly in the same way.

10 Turn the crankshaft through 180° to bring pistons 2 and 3 to BDC (bottom dead centre), and remove them in the same way.

### 11 Crankshaft – removal



1 Remove the crankshaft sprocket and the oil



10.5 Removing a big-end bearing cap and shell

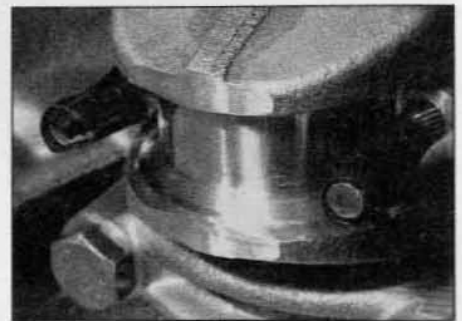

10.6 To protect the crankshaft journals, tape over the connecting rod stud threads

pump as described in Part B or C of this Chapter (as applicable).

2 Remove the pistons and connecting rods, as described in Section 10. If no work is to be done on the pistons and connecting rods, there is no need to remove the cylinder head, or to push the pistons out of the cylinder bores. The pistons should just be pushed far enough up the bores so that they are positioned clear of the crankshaft journals.

3 Check the crankshaft endfloat as described in Section 14, then proceed as follows.

4 Slacken and remove the retaining bolts, and remove the oil seal carrier from the timing belt end of the cylinder block, along with its gasket (where fitted) (see illustration).

5 Remove the oil pump drive chain, and slide the drive sprocket and spacer (where fitted)

off the end of the crankshaft. Remove the Woodruff key, and store it with the sprocket for safe-keeping (see illustrations).

6 The main bearing caps should be numbered 1 to 5, starting from the transmission (flywheel) end of the engine (see illustration). If not, mark them accordingly using a centre-punch. Also note the correct fitted depth of the crankshaft oil seal in the bearing cap.

7 Slacken and remove the main bearing cap retaining bolts, and lift off each bearing cap. Recover the lower bearing shells, and tape them to their respective caps for safe-keeping. Also recover the lower thrustwasher halves from the side of No 2 main bearing cap (see illustration). Remove the sealing strips from the sides of No 1 main bearing cap, and discard them.

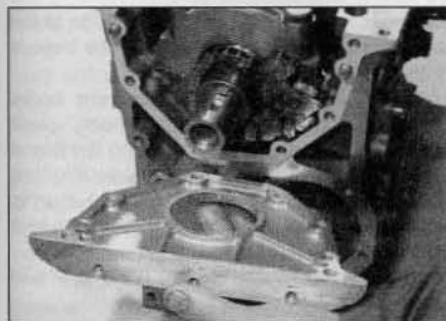

11.4 Removing the oil seal carrier from the block

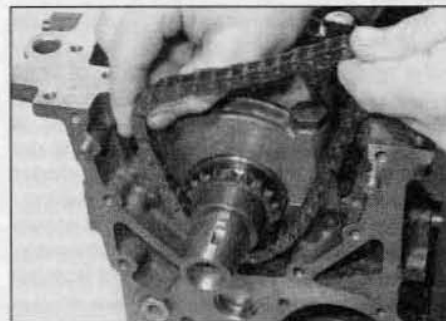

11.5a Remove the oil pump drive chain ...



11.5b ... then slide off the drive sprocket ...



11.5c ... and remove the Woodruff key from the crankshaft

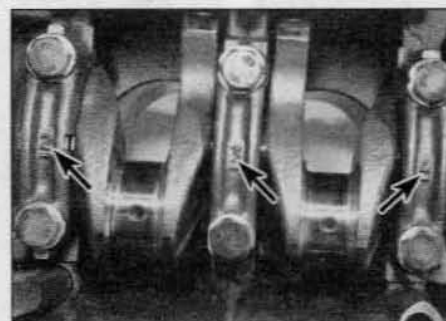

11.6 Main bearing cap identification markings (arrowed)



11.7 Removing No 2 main bearing cap. Note the thrustwasher (arrowed)



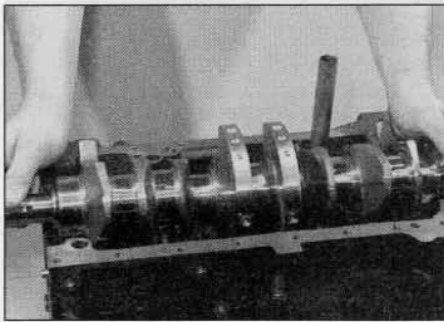

11.8 Lifting out the crankshaft

8 Lift out the crankshaft (see illustration), and discard the oil seal.

9 Recover the upper bearing shells from the cylinder block (see illustration), and tape them to their respective caps for safe-keeping. Remove the upper thrustwasher halves from the side of No 2 main bearing, and store them with the lower halves.

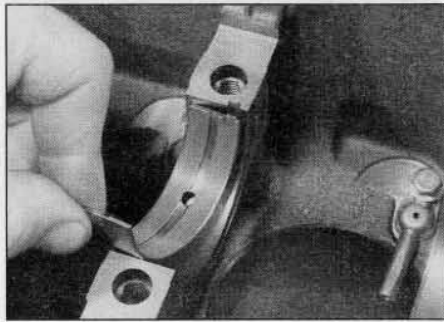

11.9 Remove the upper main bearing shells from the cylinder block/crankcase, and store them with their lower shells

5 Remove all oil gallery plugs (where fitted). The plugs are usually very tight – they may have to be drilled out, and the holes retapped. Use new plugs when the engine is reassembled.

6 If any of the castings are extremely dirty, all should be steam-cleaned.

7 After the castings are returned, clean all oil holes and oil galleries one more time. Flush all internal passages with warm water until the water runs clear. Dry thoroughly, and apply a light film of oil to the cylinder bores and all mating surfaces, to prevent rusting. If you have access to compressed air, use it to speed up the drying process, and to blow out all the oil holes and galleries.



**Warning: Wear eye protection when using compressed air.**

8 If the castings are not very dirty, you can do an adequate cleaning job with hot, soapy water and a stiff brush. Take plenty of time, and do a thorough job. Regardless of the cleaning method used, be sure to clean all oil holes and galleries very thoroughly, and to dry all components well. Protect the cylinder bores as described above, to prevent rusting.

9 All threaded holes must be clean, to ensure accurate torque readings during reassembly. To clean the threads, run the correct-size tap

into each of the holes to remove rust, corrosion, thread sealant or sludge, and to restore damaged threads (see illustration). If possible, use compressed air to clear the holes of debris produced by this operation.



**Warning: Wear eye protection when using compressed air.**

10 Apply suitable sealant to the new oil gallery plugs, and insert them into the holes in the block. Tighten them securely. Also apply suitable sealant to new core plugs, and drive them into the block using a tube or socket.

11 On engines with piston oil jet spray tubes, clean the threads of each oil jet retaining bolt, and apply a drop of thread-locking compound to the bolt threads. Refit the piston oil jet spray tubes to the cylinder block, and tighten the retaining bolts to the specified torque setting.

12 If the engine is not going to be reassembled right away, cover it with a large plastic bag to keep it clean; protect all mating surfaces and the cylinder bores as described above, to prevent rusting.

### Inspection

13 Visually check the castings for cracks and corrosion. Look for stripped threads in the threaded holes. If there has been any history of internal water leakage, it may be worthwhile having an engine overhaul specialist check the cylinder block/crankcase with special equipment. If defects are found, have them repaired if possible, or renew the assembly.

14 Check each cylinder bore for scuffing and scoring. Check for signs of a wear ridge at the top of the cylinder, indicating that the bore is excessively worn.

15 Accurate measuring of the cylinder bores requires specialised equipment and experience. We recommend having the bores measured by an engine reconditioning specialist who will also be able to supply appropriate pistons (where possible) should a rebore be necessary.

16 If the cylinder bores and pistons are in

## 12 Cylinder block/crankcase – cleaning and inspection



### Cleaning

1 Remove all external components and electrical switches/sensors from the block. For complete cleaning, the core plugs should ideally be removed (see illustration). Drill a small hole in the plugs, then insert a self-tapping screw into the hole.

2 Pull out the plugs by pulling on the screw with a pair of grips, or by using a slide hammer.

3 Where fitted, undo the retaining bolts and remove the piston oil jet spray tubes from inside the cylinder block.

4 Scrape all traces of gasket from the cylinder block/crankcase, taking care not to damage the gasket/sealing surfaces.

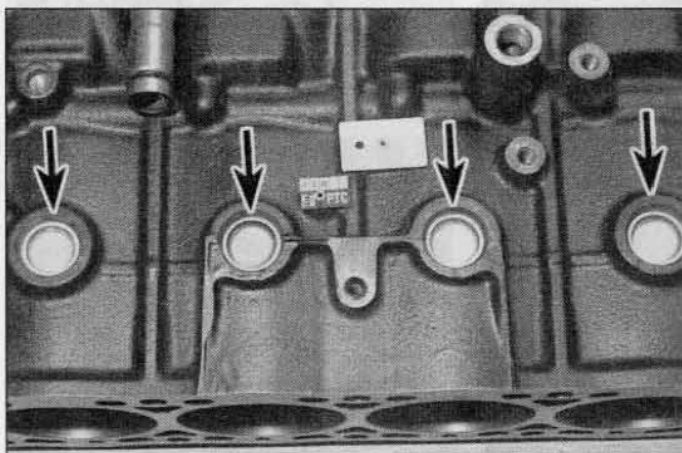

12.1 Cylinder block core plugs (arrowed)



12.9 Cleaning a cylinder block threaded hole using a suitable tap



reasonably good condition, and not worn beyond the specified limits, and if the piston-to-bore clearances can be maintained, then it will only be necessary to renew the piston rings. If this is the case, the cylinder bores must be honed to allow the new piston rings to bed in correctly and provide the best possible seal. An engine reconditioning specialist will carry out this work at moderate cost.

**17** At the time of writing, it was not clear whether oversize pistons were available for all models. Consult your Peugeot/Citroën dealer or engine specialist for the latest information on piston availability. If oversize pistons are available (either from Peugeot/Citroën, or from another source), then it may be possible to have the cylinder bores rebored and fit the oversize pistons. If oversize pistons are not available, and the bores are worn, renewal of the block seems to be the only option.

### 13 Piston/connecting rod assembly - inspection



**1** Before the inspection process can begin, the piston/connecting rod assemblies must be cleaned, and the original piston rings removed from the pistons.

**2** Carefully expand the old rings over the top of the pistons. The use of two or three old feeler blades will be helpful in preventing the rings dropping into empty grooves (see illustration). Be careful not to scratch the piston with the ends of the ring. The rings are brittle, and will snap if they are spread too far. They are also very sharp - protect your hands and fingers. Note that the third ring incorporates an expander. Always remove the rings from the top of the piston. Keep each set of rings with its piston if the old rings are to be re-used.

**3** Scrape away all traces of carbon from the top of the piston. A hand-held wire brush (or a piece of fine emery cloth) can be used, once the majority of the deposits have been scraped away.

**4** Remove the carbon from the ring grooves in the piston, using an old ring. Break the ring in half to do this (be careful not to cut your fingers - piston rings are sharp).



**13.2** Removing a piston ring with the aid of a feeler blade

**Caution:** Be careful to remove only the carbon deposits - do not remove any metal, and do not nick or scratch the sides of the ring grooves.

**5** Once the deposits have been removed, clean the piston/connecting rod assembly with paraffin or a suitable solvent, and dry thoroughly. Make sure that the oil return holes in the ring grooves are clear.

**6** If the pistons and cylinder bores are not damaged or worn excessively, and if the cylinder block does not need to be rebored, the original pistons can be refitted. Normal piston wear shows up as even vertical wear on the piston thrust surfaces, and slight looseness of the top ring in its groove. New piston rings should always be used when the engine is reassembled.

**7** Carefully inspect each piston for cracks around the skirt, around the gudgeon pin holes, and at the piston ring 'lands' (between the ring grooves).

**8** Look for scoring and scuffing on the piston skirt, holes in the piston crown, and burned areas at the edge of the crown. If the skirt is scored or scuffed, the engine may have been suffering from overheating, and/or abnormal combustion which caused excessively high operating temperatures. The cooling and lubrication systems should be checked thoroughly. Scorch marks on the sides of the pistons show that blow-by has occurred. A hole in the piston crown, or burned areas at the edge of the piston crown, indicates that abnormal combustion has been occurring. If any of the above problems exist, the causes must be investigated and corrected, or the

damage will occur again. The causes may include incorrect injection pump timing, or a faulty injector (as applicable).

**9** Corrosion of the piston, in the form of pitting, indicates that coolant has been leaking into the combustion chamber and/or the crankcase. Again, the cause must be corrected, or the problem may persist in the rebuilt engine.

**10** Examine each connecting rod carefully for signs of damage, such as cracks around the big-end and small-end bearings. Check that the rod is not bent or distorted. Damage is highly unlikely, unless the engine has been seized or badly overheated. Detailed checking of the connecting rod assembly can only be carried out by an engine specialist with the necessary equipment.

**11** The connecting rod big-end cap nuts must be renewed whenever they are disturbed. Although Peugeot/Citroën do not specify that the bolts must also be renewed, it is recommended that the nuts and bolts are renewed as a complete set.

**12** The gudgeon pins are of the floating type, secured in position by two circlips. The pistons and connecting rods can be separated as follows.

**13** Using a small flat-bladed screwdriver, prise out the circlips, and push out the gudgeon pin (see illustrations). Hand pressure should be sufficient to remove the pin. Identify the piston and rod to ensure correct reassembly. Discard the circlips - new ones must be used on refitting.

**14** Examine the gudgeon pin and connecting rod small-end bearing for signs of wear or damage. Wear can be cured by renewing both the pin and bush. Bush renewal, however, is a specialist job - press facilities are required, and the new bush must be reamed accurately.

**15** The connecting rods themselves should not be in need of renewal, unless seizure or some other major mechanical failure has occurred. Check the alignment of the connecting rods visually, and if the rods are not straight, take them to an engine overhaul specialist for a more detailed check.

**16** Examine all components, and obtain any new parts from your Peugeot/Citroën dealer or engine reconditioning specialist. If new pistons are purchased, they will be supplied

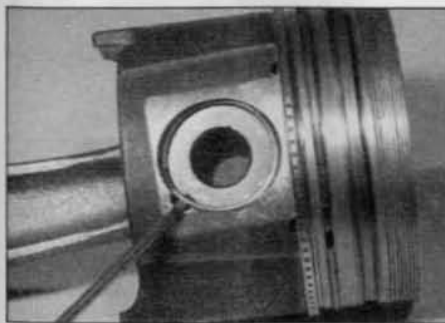

**13.13a** Prise out the circlip ...



**13.13b** ... withdraw the gudgeon pin ...

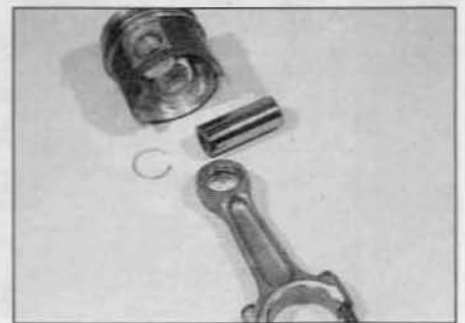

**13.13c** ... and separate the piston from the connecting rod

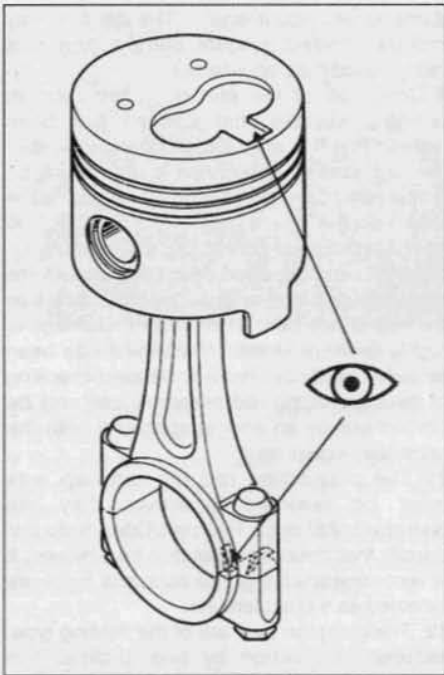

**13.17a** On 1.8 and 1.9 litre engines, ensure that the piston cut-out is positioned as shown, in relation to the connecting rod bearing shell cut-out

complete with gudgeon pins and circlips. Circlips can also be purchased individually.

**17** Position the piston so that the cut-out or arrow on the piston crown, or the valve recesses on the piston crown, are positioned as shown in relation to the connecting rod big-end bearing shell cut-outs (see illustrations). Apply a smear of clean engine oil to the gudgeon pin. Slide it into the piston and through the connecting rod small-end. Check that the piston pivots freely on the rod, then secure the gudgeon pin in position with two new circlips. Ensure that each circlip is correctly located in its groove in the piston.

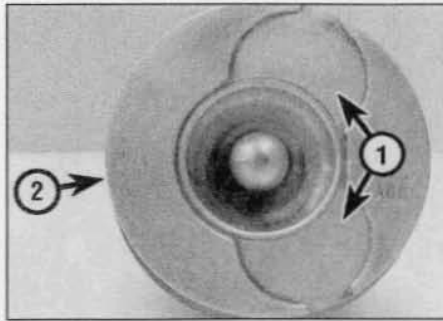

**13.17b** On 2.0 litre engines, the valve recesses (1) on the piston crown must be on the opposite side to the connecting rod bearing shell cut-out (2 - not visible)

#### 14 Crankshaft - inspection

##### Checking endfloat

**1** If the crankshaft endfloat is to be checked, this must be done when the crankshaft is still installed in the cylinder block/crankcase, but is free to move (see Section 11).

**2** Check the endfloat using a dial gauge in contact with the end of the crankshaft. Push the crankshaft fully one way, and then zero the gauge. Push the crankshaft fully the other way, and check the endfloat. The result can be compared with the specified amount, and will give an indication as to whether new thrustwashers are required (see illustration).

**3** If a dial gauge is not available, feeler blades can be used. First push the crankshaft fully towards the flywheel end of the engine, then use feeler blades to measure the gap between the web of No 2 crankpin and the thrustwasher (see illustration).

##### Inspection

**4** Clean the crankshaft using paraffin or a suitable solvent, and dry it, preferably with

compressed air if available. Be sure to clean the oil holes with a pipe cleaner or similar probe, to ensure that they are not obstructed.



**Warning:** Wear eye protection when using compressed air.

**5** Check the main and big-end bearing journals for uneven wear, scoring, pitting and cracking.

**6** Big-end bearing wear is accompanied by distinct metallic knocking when the engine is running (particularly noticeable when the engine is pulling from low speed) and some loss of oil pressure.

**7** Main bearing wear is accompanied by severe engine vibration and rumble - getting progressively worse as engine speed increases - and again by loss of oil pressure.

**8** Check the bearing journal for roughness by running a finger lightly over the bearing surface. Any roughness (which will be accompanied by obvious bearing wear) indicates that the crankshaft requires regrinding (where possible) or renewal.

**9** Check the oil seal contact surfaces at each end of the crankshaft for wear and damage. If the seal has worn a deep groove in the surface of the crankshaft, consult an engine overhaul specialist; repair may be possible, but otherwise a new crankshaft will be required.

**10** Take the crankshaft to an engine reconditioning specialist to have it measured for journal wear. If excessive wear is evident, they will be able to advise you with regard to regrinding the crankshaft and supplying new bearing shells.

**11** If the crankshaft has been reground, check for burrs around the crankshaft oil holes (the holes are usually chamfered, so burrs should not be a problem unless regrinding has been carried out carelessly). Remove any burrs with a fine file or scraper, and thoroughly clean the oil holes as described previously.

**12** At the time of writing, it was not clear

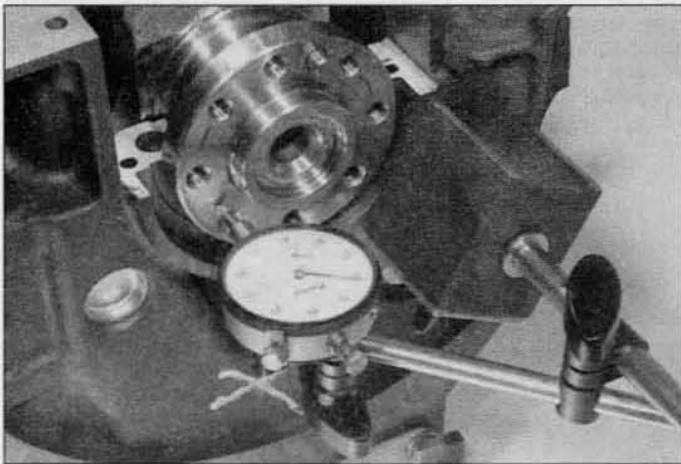

**14.2** Checking crankshaft endfloat using a dial gauge

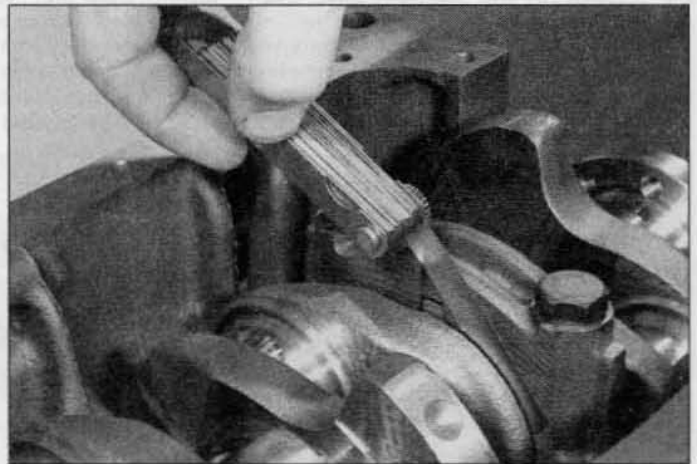

**14.3** Checking crankshaft endfloat using feeler blades



whether Peugeot/Citroën produce oversize bearing shells for all of these engines. On some engines, if the crankshaft journals have not already been reground, it may be possible to have the crankshaft reconditioned, and to fit oversize shells. If no oversize shells are available and the crankshaft has worn beyond the specified limits, it will have to be renewed. Consult your dealer or engine specialist for further information on parts availability.

### 15 Main and big-end bearings – inspection



**1** Even though the main and big-end bearings should be renewed during the engine overhaul, the old bearings should be retained for close examination, as they may reveal valuable information about the condition of the engine. The bearing shells are graded by thickness, the grade of each shell being indicated by the colour code marked on it.

**2** Bearing failure can occur due to lack of lubrication, the presence of dirt or other foreign particles, overloading the engine, or corrosion (see illustration). Regardless of the cause of bearing failure, the cause must be corrected (where applicable) before the engine is reassembled, to prevent it from happening again.

**3** When examining the bearing shells, remove them from the cylinder block/crankcase, the main bearing ladder/caps (as appropriate), the connecting rods and the connecting rod big-end bearing caps. Lay them out on a clean surface in the same general position as their location in the engine. This will enable you to match any bearing problems with the corresponding crankshaft journal.

**Caution: Do not touch any shell's bearing**

**surface with your fingers while checking it, or the delicate surface may be scratched.**

**4** Dirt and other foreign matter gets into the engine in a variety of ways. It may be left in the engine during assembly, or it may pass through filters or the crankcase ventilation system. It may get into the oil, and from there into the bearings. Metal chips from machining operations and normal engine wear are often present. Abrasives are sometimes left in engine components after reconditioning, especially when parts are not thoroughly cleaned using the proper cleaning methods. Whatever the source, these foreign objects often end up embedded in the soft bearing material, and are easily recognised. Large particles will not embed in the bearing, and will score or gouge the bearing and journal. The best prevention for this cause of bearing failure is to clean all parts thoroughly, and keep everything spotlessly-clean during engine assembly. Frequent and regular engine oil and filter changes are also recommended.

**5** Lack of lubrication (or lubrication breakdown) has a number of interrelated causes. Excessive heat (which thins the oil), overloading (which squeezes the oil from the bearing face) and oil leakage (from excessive bearing clearances, worn oil pump or high engine speeds) all contribute to lubrication breakdown. Blocked oil passages, which usually are the result of misaligned oil holes in a bearing shell, will also oil-starve a bearing, and destroy it. When lack of lubrication is the cause of bearing failure, the bearing material is wiped or extruded from the steel backing of the bearing. Temperatures may increase to the point where the steel backing turns blue from overheating.

**6** Driving habits can have a definite effect on bearing life. Full-throttle, low-speed operation (labouring the engine) puts very high loads on bearings, tending to squeeze out the oil film. These loads cause the bearings to flex, which produces fine cracks in the bearing face (fatigue failure). Eventually, the bearing material will loosen in pieces, and tear away from the steel backing.

**7** Short-distance driving leads to corrosion of bearings, because insufficient engine heat is produced to drive off the condensed water and corrosive gases. These products collect in the engine oil, forming acid and sludge. As the oil is carried to the engine bearings, the acid attacks and corrodes the bearing material.

**8** Incorrect bearing installation during engine assembly will lead to bearing failure as well. Tight-fitting bearings leave insufficient bearing running clearance, and will result in oil starvation. Dirt or foreign particles trapped behind a bearing shell result in high spots on the bearing, which lead to failure.

**Caution: Do not touch any shell's bearing surface with your fingers during reassembly; there is a risk of scratching the delicate surface, or of depositing particles of dirt on it.**

**9** As mentioned at the beginning of this Section, the bearing shells should be renewed as a matter of course during engine overhaul; to do otherwise is false economy.

### 16 Engine overhaul – reassembly sequence

**1** Before reassembly begins, ensure that all new parts have been obtained, and that all necessary tools are available. Read through the entire procedure to familiarise yourself with the work involved, and to ensure that all items necessary for reassembly of the engine are at hand. In addition to all normal tools and materials, thread-locking compound will be needed. A suitable tube of liquid sealant will also be required for the joint faces that are fitted without gaskets. It is recommended that Peugeot/Citroën's own product(s) are used, which are specially formulated for this purpose; the relevant product names are quoted in the text of each Section where they are required.

**2** In order to save time and avoid problems, engine reassembly can be carried out in the following order:

- a) Crankshaft (See Section 18).
- b) Piston/connecting rod assemblies (See Section 19).
- c) Oil pump (See Part B or C – as applicable).
- d) Sump (See Part B or C – as applicable).
- e) Flywheel (See Part B or C – as applicable).
- f) Cylinder head (See Part B or C, or Section 5 of this Part – as applicable).
- g) Timing belt tensioner and sprockets, and timing belt (See Part B or C – as applicable).
- h) Engine external components.

**3** At this stage, all engine components should be absolutely clean and dry, with all faults repaired. The components should be laid out (or in individual containers) on a completely clean work surface.

### 17 Piston rings – refitting



**1** Before fitting new piston rings, the ring end gaps must be checked as follows.

**2** Lay out the piston/connecting rod assemblies and the new piston ring sets, so that the ring sets will be matched with the same piston and cylinder during the end gap measurement and subsequent engine reassembly.

**3** Insert the top ring into the first cylinder, and push it down the bore using the top of the piston. This will ensure that the ring remains square with the cylinder walls. Position the ring near the bottom of the cylinder bore, at the lower limit of ring travel. Note that the top

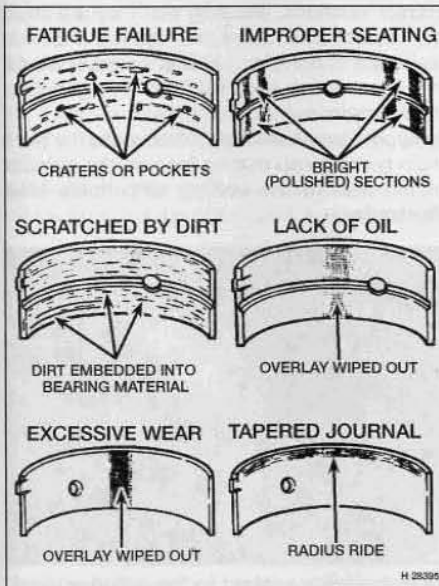

15.2 Typical bearing failures



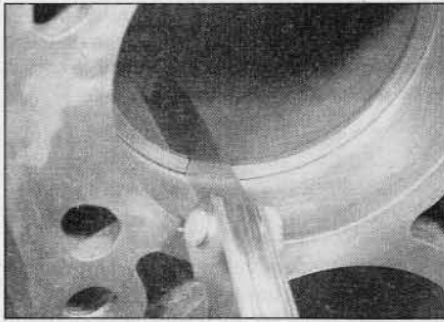

17.5 Measuring a piston ring end gap

and second compression rings are different. The second ring is easily identified by the step on its lower surface, and by the fact that its outer face is tapered.

4 Measure the end gap using feeler blades.  
5 Repeat the procedure with the ring at the top of the cylinder bore, at the upper limit of its travel (see illustration), and compare the measurements with the figures given in the Specifications. If the end gaps are incorrect, check that you have the correct rings for your engine and for the cylinder bore size.

6 Repeat the checking procedure for each ring in the first cylinder, and then for the rings in the remaining cylinders. Remember to keep rings, pistons and cylinders matched up.

7 Once the ring end gaps have been checked and if necessary corrected, the rings can be fitted to the pistons.

8 Fit the piston rings using the same technique as for removal. Fit the bottom (oil control) ring first, and work up. When fitting the oil control ring, first insert the expander (where fitted), then fit the ring with its gap positioned 180° from the expander gap. Ensure that the second compression ring is fitted the correct way up, with its identification mark (either a dot of paint or the word TOP stamped on the ring surface) at the top, and the stepped surface at the bottom (see illustration). Arrange the gaps of the top and second compression rings 120° either side of the oil control ring gap.

**Note:** Always follow any instructions supplied with the new piston ring sets - different

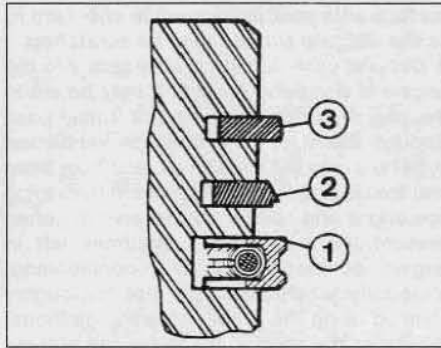

17.8 Piston ring fitting diagram (typical)

- 1 Oil control ring
- 2 Second compression ring
- 3 Top compression ring

manufacturers may specify different procedures. Do not mix up the top and second compression rings, as they have different cross-sections.

## 18 Crankshaft - refitting

### Selection of bearing shells

1 Have the crankshaft inspected and measured by an engine reconditioning specialist. They will be able to carry out any regrinding/repairs, and supply suitable main and big-end bearing shells.

### Crankshaft refitting

2 Where applicable, ensure that the oil spray jets are fitted to the bearing locations in the cylinder block.

3 Using a little grease, stick the upper thrustwashers to each side of the No 2 main bearing upper location. Ensure that the oilway grooves on each thrustwasher face outwards (away from the cylinder block) (see illustration).

4 Clean the backs of the bearing shells, and the bearing locations in both the cylinder block/crankcase and the main bearing caps. Press the bearing shells into their locations,



18.3 Fit the upper thrustwashers to the No 2 main bearing location with the oilway grooves facing outwards

ensuring that the tab on each shell engages in the notch in the cylinder block/crankcase or main bearing cap. Take care not to touch any shell's bearing surface with your fingers. Note that the upper bearing shells all have a grooved bearing surface, whereas the lower shells have a plain bearing surface (see illustrations). If new shells are being fitted, ensure that all traces of protective grease are cleaned off using paraffin. Wipe dry the shells and connecting rods with a lint-free cloth. Liberally lubricate each bearing shell in the cylinder block/crankcase and cap with clean engine oil.

5 Lower the crankshaft into position so that Nos 2 and 3 cylinder crankpins are at TDC; Nos 1 and 4 cylinder crankpins will be at BDC, ready for fitting No 1 piston. Check the crankshaft endfloat as described in Section 14.

6 Lubricate the lower bearing shells in the main bearing caps with clean engine oil. Make sure that the locating lugs on the shells engage with the corresponding recesses in the caps.

7 Fit main bearing caps Nos 2 to 5 to their correct locations, ensuring that they are fitted the correct way round (the bearing shell tab recesses in the block and caps must be on the same side). Insert the bolts, tightening them only loosely at this stage.

8 Apply a small amount of sealant to the No 1 main bearing cap mating face on the cylinder block, around the sealing strip holes (see illustration).

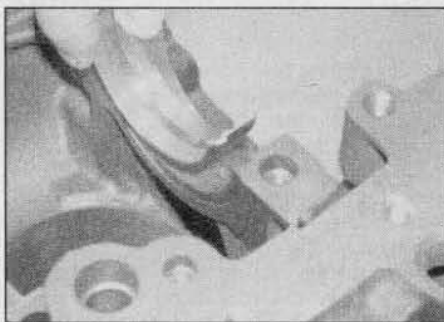

18.4a Fit the bearing shells, ensuring that the tab engages in the notch in the cylinder block/crankcase ...

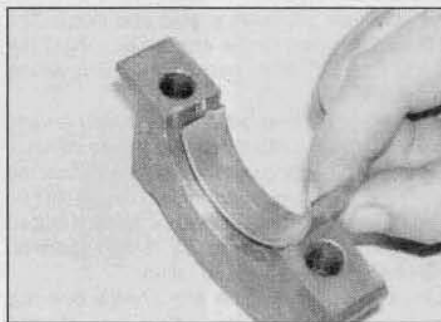

18.4b ... and bearing cap

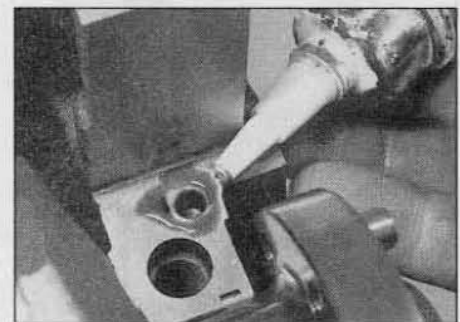

18.8 Applying sealant to the cylinder block No 1 main bearing cap mating face



**18.9a** Fitting a sealing strip to No 1 main bearing cap

**9** Locate the tab of each sealing strip over the pins on the base of No 1 bearing cap, and press the strips into the bearing cap grooves. It is now necessary to obtain two thin metal strips, of 0.25 mm thickness or less, in order to prevent the strips moving when the cap is being fitted. Peugeot/Citroën garages use the tool shown, which acts as a clamp. Metal strips (such as old feeler blades) can be used, provided all burrs which may damage the sealing strips are first removed (see illustrations).

**10** Oil both sides of the metal strips, and hold them on the sealing strips. Fit the No 1 main bearing cap, insert the bolts loosely, then carefully pull out the metal strips in a horizontal direction, using a pair of pliers (see illustrations).

**11** Tighten all the main bearing cap bolts evenly to the specified torque and, on 2.0 litre engines, additionally through the specified angle.

**12** Check that the sealing strips protrude slightly from above the cylinder block/crankcase mating surface by approximately 1.0 mm. If not, remove the bearing cap again and refit; the seals are supplied the correct length and should not be cut. Also check that the crankshaft rotates freely.

**13** Fit a new crankshaft oil seal as described in Chapter 2B or 2C (as applicable).

**14** Refit the piston/connecting rod assemblies to the crankshaft as described in Section 19.

**15** Refit the Woodruff key, then slide on the oil pump drive sprocket and spacer (where

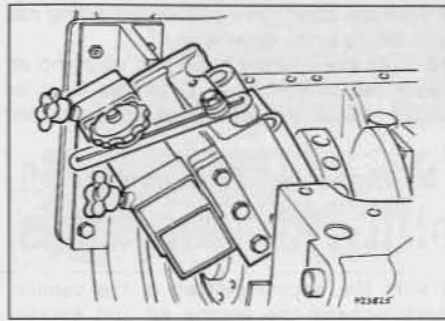

**18.9b** Using the Peugeot special tool to fit No 1 main bearing cap

fitted), and locate the drive chain on the sprocket.

**16** Ensure that the mating surfaces of the oil seal carrier and cylinder block are clean and dry. Note the correct fitted depth of the oil seal then, using a large flat-bladed screwdriver, lever the old seal out of the housing.

**17** Apply a smear of suitable sealant to the oil seal carrier mating surface. Ensure that the locating dowels are in position, then slide the carrier over the end of the crankshaft and into position on the cylinder block. Tighten the carrier retaining bolts to the specified torque.

**18** Fit a new crankshaft oil seal as described in Chapter 2B or 2C (as applicable).

**19** Ensuring that the drive chain is correctly located on the sprocket, refit the oil pump and sump as described in Chapter 2B or 2C (as applicable).

**20** Where removed, refit the cylinder head as described in Part B or C of this Chapter, or in Section 5 of this Part (as applicable).

### 19 Piston/connecting rod assembly – refitting

**Note:** New big-end bearing cap nuts must be used on refitting.

**1** Note that the following procedure assumes that the crankshaft and main bearing caps are in place (see Section 18).

**2** Clean the backs of the bearing shells, and



**18.10a** Fitting No 1 main bearing cap, using metal strips to retain the side seals

the bearing locations in both the connecting rod and bearing cap. Press the bearing shells into their locations, ensuring that the tab on each shell engages in the notch in the connecting rod and cap (see illustration). Take care not to touch any shell's bearing surface with your fingers. If new shells are being fitted, ensure that all traces of the protective grease are cleaned off using paraffin. Wipe dry the shells and connecting rods with a lint-free cloth.

**3** Lubricate the cylinder bores, the pistons, and piston rings, then lay out each piston/connecting rod assembly in its respective position.

**4** Start with assembly No 1. Make sure that the piston rings are still spaced as described in Section 17; then clamp them in position with a piston ring compressor. Insert the piston/connecting rod assembly into the top of cylinder No 1, ensuring the piston is correctly positioned as follows.

- a) On 1.8 and 1.9 litre engines, ensure that the cloverleaf-shaped cut-out on the piston crown is towards the front (oil filter side) of the cylinder block.
- b) On 2.0 litre engines, ensure that the valve recesses on the piston crown are towards the rear of the cylinder block.

**5** Using a block of wood or hammer handle against the piston crown, tap the assembly into the cylinder/liner until the piston crown is flush with the top of the cylinder (see illustration).

**6** Ensure that the bearing shell is still correctly installed. Liberally lubricate the crankpin and

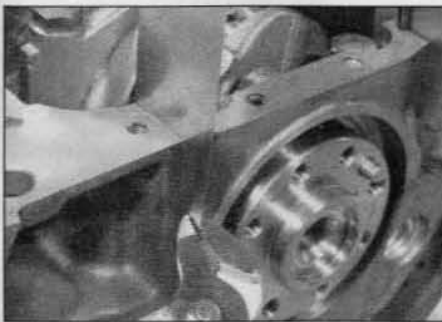

**18.10b** Removing a metal strip from No 1 main bearing cap using a pair of pliers

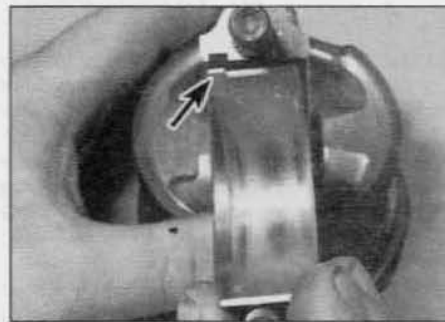

**19.2** Fitting a bearing shell to a connecting rod – ensure the tab (arrowed) engages with the recess in the connecting rod

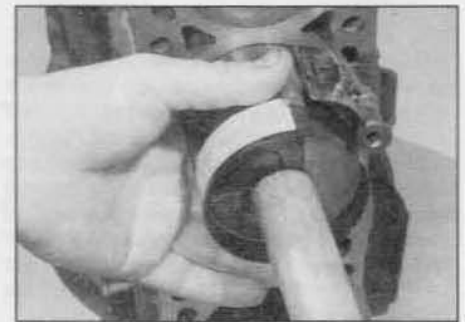

**19.5** Tap the piston into the bore using a hammer handle

both bearing shells. Taking care not to mark the cylinder bores, pull the piston/connecting rod assembly down the bore and onto the crankpin. Refit the big-end bearing cap, tightening the nuts finger-tight at first. Note that the faces with the identification marks must match (which means that the bearing shell locating tabs abut each other).

**7** Tighten the bearing cap retaining nuts evenly and progressively to the Stage 1 torque setting. Once both nuts have been tightened to the Stage 1 setting, angle-tighten them through the specified Stage 2 angle, using a socket and extension bar. It is recommended that an angle-measuring gauge is used during this stage of the tightening, to ensure accuracy.

**8** Once the bearing cap retaining nuts have been correctly tightened, rotate the crankshaft. Check that it turns freely; some stiffness is to be expected if new components have been fitted, but there should be no signs of binding or tight spots.

**9** Refit the other three piston/connecting rod assemblies in the same way.

**10** Refit the cylinder head and oil pump as described in Part B or C of this Chapter and/or in Section 5 of this Part (as applicable).

## 20 Engine – initial start-up after overhaul

**1** With the engine refitted in the vehicle, double-check the engine oil and coolant levels (see *Weekly checks*). Make a final check that everything has been reconnected, and that there are no tools or rags left in the engine compartment.

**2** Switch on the ignition and immediately turn the engine on the starter (do not allow the glow plugs to heat up) until the oil pressure warning light goes out.

**3** Prime the fuel system as described in the relevant Part of Chapter 4, then start the

engine, noting that this may take a little longer than usual, due to the fuel system components having been disturbed.

**4** While the engine is idling, check for fuel, water and oil leaks. Don't be alarmed if there are some odd smells and smoke from parts getting hot and burning off oil deposits.

**5** Assuming all is well, keep the engine idling until hot water is felt circulating through the top hose, then switch off the engine.

**6** Allow the engine to cool then recheck the oil and coolant levels as described in *Weekly checks*, and top-up as necessary.

**7** If they were tightened as described, there is no need to retighten the cylinder head bolts once the engine has first run after reassembly.

**8** If new pistons, rings or crankshaft bearings have been fitted, the engine must be treated as new, and run-in for the first 500 miles (800 km). Do not operate the engine at full-throttle, or allow it to labour at low engine speeds in any gear. It is recommended that the oil and filter be changed at the end of this period.



## Chapter 3

# Cooling, heating and air conditioning systems

## Contents

	Section number		Section number
Air conditioning compressor (auxiliary) drivebelt – checking and renewal	See Chapter 1A or 1B	Cooling system electrical switches and sensors – removal and refitting	6
Air conditioning system – general information and precautions	11	Cooling system hoses – disconnection and renewal	2
Air conditioning system components – removal and refitting	12	Electric cooling fan(s) – removal and refitting	5
Air conditioning system refrigerant check	See Chapter 1A or 1B	General information and precautions	1
Antifreeze mixture	See Chapter 1A or 1B	Heater/ventilation components – removal and refitting	10
Coolant level check	See <i>Weekly checks</i>	Heating and ventilation system – general information	9
Coolant pump – removal and refitting	7	Radiator – removal, inspection and refitting	3
Cooling system – draining	See Chapter 1A or 1B	Thermostat – removal, testing and refitting	4
Cooling system – filling	See Chapter 1A or 1B	Thermostat/fuel filter housing (1.8 and 1.9 litre diesel models) – removal and refitting	8
Cooling system – flushing	See Chapter 1A or 1B		

## Degrees of difficulty

**Easy**, suitable for novice with little experience



**Fairly easy**, suitable for beginner with some experience



**Fairly difficult**, suitable for competent DIY mechanic



**Difficult**, suitable for experienced DIY mechanic



**Very difficult**, suitable for expert DIY or professional



## Specifications

### General

Maximum system pressure ..... 1.4 bars

### Thermostat

Opening temperatures:

Starts to open:

Petrol engine models ..... 89°C

Diesel engine models ..... 83°C

Fully-open ..... 99°C

### Torque wrench settings

	Nm	lbf ft
Coolant pump housing bolts (aluminium block petrol engines):		
Smaller bolts	30	22
Larger bolts	65	48
Coolant pump securing bolts (cast-iron iron block engines)	15	11

### 1 General information and precautions

#### General information

The cooling system is of pressurised type, comprising a coolant pump driven by the timing belt, an aluminium crossflow radiator, expansion tank, electric cooling fan(s), a thermostat, heater matrix, and all associated hoses and switches.

The system functions as follows. Cold

coolant in the bottom of the radiator passes through the bottom hose to the coolant pump, where it is pumped around the cylinder block and head passages, and through the oil cooler(s) (where fitted). After cooling the cylinder bores, combustion surfaces and valve seats, the coolant reaches the underside of the thermostat, which is initially closed. The coolant passes through the heater, and is returned via the cylinder block to the coolant pump.

When the engine is cold, the coolant circulates only through the cylinder block, cylinder head, and heater. When the coolant

reaches a predetermined temperature, the thermostat opens, and the coolant passes through the top hose to the radiator. As the coolant circulates through the radiator, it is cooled by the inrush of air when the car is in forward motion. The airflow is supplemented by the action of the electric cooling fan(s) when necessary. Upon reaching the bottom of the radiator, the coolant has now cooled, and the cycle is repeated.

When the engine is at normal operating temperature, the coolant expands, and some of it is displaced into the expansion tank. Coolant collects in the tank, and is returned to

the radiator when the system cools.

The electric cooling fan(s) mounted in front of the radiator are controlled by a thermostatic switch/sensor. At a predetermined coolant temperature, the switch/sensor actuates the fan.

**Precautions**



**Warning:** Do not attempt to remove the expansion tank filler cap, or to disturb any part of the cooling system, while the engine is hot, as there is a high risk of scalding. If the expansion tank filler cap must be removed before the engine and radiator have fully cooled (even though this is not recommended), the pressure in the cooling system must first be relieved. Cover the cap with a thick layer of cloth to avoid scalding, and slowly unscrew the filler cap until a hissing sound is heard. When the hissing has stopped, indicating that the pressure has reduced, slowly unscrew the filler cap until it can be removed; if more hissing sounds are heard, wait until they have stopped before unscrewing the cap. At all times, keep well away from the filler cap opening, and protect your hands.



**Warning:** Do not allow antifreeze to come into contact with your skin, or with the painted surfaces of the vehicle. Rinse off spills immediately, with plenty of water. Never leave antifreeze lying around in an open container, or in a puddle in the driveway or on the garage floor. Children and pets are attracted by its sweet smell, but antifreeze can be fatal if ingested.



**Warning:** If the engine is hot, the electric cooling fan may start rotating even if the engine is not running. Be careful to keep your hands, hair and any loose clothing well clear when working in the engine compartment.



**Warning:** Refer to Section 11 for precautions to be observed when working on models equipped with air conditioning.

**2 Cooling system hoses – disconnection and renewal**



**Note:** Refer to the warnings given in Section 1 of this Chapter before proceeding. Hoses should only be disconnected once the engine has cooled sufficiently to avoid scalding.

1 If the checks described in Chapter 1A or 1B reveal a faulty hose, it must be renewed as follows.

2 First drain the cooling system (Chapter 1A or 1B). If the coolant is not due for renewal, it may be re-used, providing it is collected in a clean container.

3 To disconnect a hose, proceed as follows, according to the type of hose connection.



2.5 Disconnecting the radiator top hose

**Conventional connections – general instructions**

4 On conventional connections, the clips used to secure the hoses in position may be either standard worm-drive clips or disposable crimped types. The crimped type of clip is not designed to be re-used and worm drive clips should be used on reassembly.

5 To disconnect a hose, use a screwdriver to slacken or release the clips, then move them along the hose, clear of the relevant inlet/outlet. Carefully work the hose free (see illustration). The hoses can be removed with relative ease when new – on an older car, they may have stuck.

6 If a hose proves to be difficult to remove, try to release it by rotating its ends before attempting to free it. Gently prise the end of the hose with a blunt instrument (such as a flat-bladed screwdriver), but do not apply too much force, and take care not to damage the pipe stubs or hoses. Note in particular that the radiator inlet stub is fragile; do not use excessive force when attempting to remove the hose. If all else fails, cut the hose with a sharp knife, then slit it so that it can be peeled off in two pieces. Although this may prove expensive if the hose is otherwise undamaged, it is preferable to buying a new radiator. Check first, however, that a new hose is readily available.

7 When fitting a hose, first slide the clips onto the hose, then work the hose into position. If crimped-type clips were originally fitted, use standard worm-drive clips when refitting the hose.

8 Work the hose into position, checking that it is correctly routed, then slide each clip back along the hose until it passes over the flared end of the relevant inlet/outlet, before tightening the clip securely.



**If the hose is stiff, use a little soapy water as a lubricant, or soften the hose by soaking it in hot water. Do not use oil or grease, which may attack the rubber.**

9 Refill the cooling system (see Chapter 1A or 1B).

10 Check thoroughly for leaks as soon as possible after disturbing any part of the cooling system.

**Bayonet-type connections**

**Note:** A new O-ring should be used when reconnecting the hose.

**Removal**

11 On certain models, the radiator bottom and/or top hose(s) may be connected to the radiator using a plastic bayonet-type connector. To disconnect this type of connector, proceed as follows.

12 Turn the locking ring (2) anti-clockwise until it contacts the stop (1) (see illustration).

13 Press the connector away from the hose, to ensure that the two retaining lugs (3) are free (see illustration).

14 Pull the hose, complete with the connector, from the radiator.

15 Recover the O-ring from the connector, and discard it; a new one must be used on refitting.

**Refitting**

16 Wipe the connector and the stub on the radiator thoroughly with a clean, lint-free cloth.

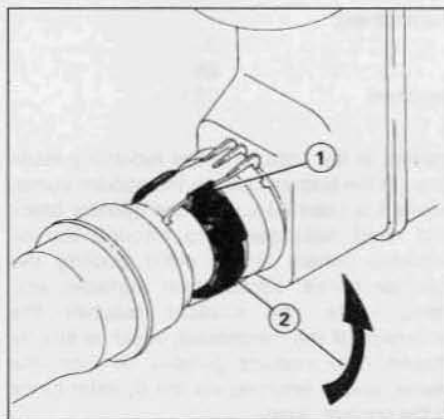

2.12 To release the bayonet-type radiator hose connection, turn the locking ring (2) until it contacts the stop (1)

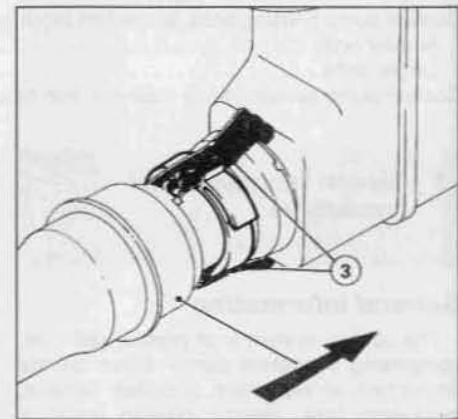

2.13 Press the connector away from the hose, to ensure that the two retaining lugs (3) are free





**2.17** On refitting, fit a new O-ring (arrowed) to the hose union

**17** Fit a new O-ring to the male half of the connector, ensuring that it is correctly seated (see illustration).

**18** Turn the locking ring clockwise until it clicks.

**19** Offer the hose to the stub on the radiator, with the locating cut-out in the male part of the connector located at the bottom (see illustration).

**20** Push the connector into the stub until both the retaining lugs click into position. Make sure that the O-ring is not trapped.

**21** Pull the connector rearwards (away from the stub) to adjust the position of the retaining lugs if necessary.

**22** Refill the cooling system (see Chapter 1A or 1B).

**23** Check thoroughly for leaks as soon as possible after disturbing any part of the cooling system.

### Spring clip type connections

**Note:** A new sealing ring should be used when reconnecting the hose.

#### Removal

**24** Some cooling system hoses may be secured in position using a wire spring clip. To disconnect this type of connector, proceed as follows.

**25** Using a small screwdriver, extract the retaining spring clip and disconnect the hose connection (see illustration). Once the hose has been disconnected, refit the spring clip to the hose union.

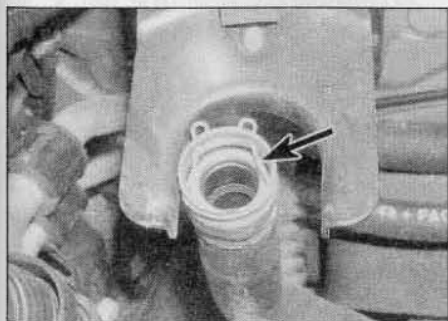

**2.27** Ensure that the sealing ring and spring clip (arrowed) are correctly fitted to the hose union before reconnecting

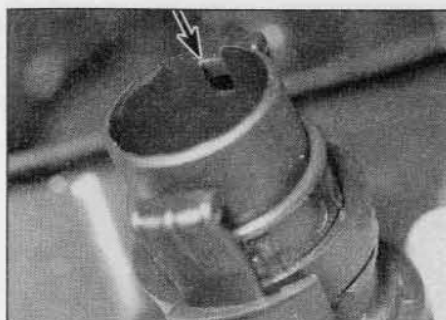

**2.19** Offer the hose to the stub on the radiator, cut-out (arrowed) at the bottom

**26** Inspect the hose unit sealing ring for signs of damage or deterioration and renew if necessary.

#### Refitting

**27** Ensure that the sealing ring is in position and the spring clip is correctly located in the groove in the union (see illustration).

**28** Lubricate the sealing ring with a smear of soapy water, to ease installation, then push the hose into position until it is heard to click into position.

**29** Ensure that the hose is securely retained by the spring clip then refill the cooling system (see Chapter 1A or 1B).

**30** Check thoroughly for leaks as soon as possible after disturbing any part of the cooling system.

### 3 Radiator – removal, inspection and refitting

**Note:** If leakage is the reason for removing the radiator, bear in mind that minor leaks can often be cured using a radiator sealant with the radiator in situ.

#### Removal – pre-September 2002 models

##### Petrol models

**1** Disconnect the battery negative terminal (refer to *Disconnecting the battery* in the Reference Chapter).



**3.6** Lift the ends of the radiator retaining clips (arrowed) and move the top of the radiator toward the engine



**2.25** Where spring clip hose connections are used, remove the spring clip then disconnect the hose

**2** Drain the cooling system as described in Chapter 1A.

**3** Remove the air cleaner assembly and air intake ducts as necessary for access to the radiator, as described in Chapter 4A.

**4** Disconnect the coolant hoses from the radiator with reference to Section 2.

**5** On models without air conditioning, where applicable, disconnect the wiring connector from the cooling fan switch or temperature sensor located on the left-hand side of the radiator.

**6** Working at the top of the radiator, lift the ends of the radiator retaining clips (one each side) and move the top of the radiator toward the engine (see illustration). Lift the radiator upward to disengage the lower locating lugs and remove the radiator from the engine compartment. Take care not to damage the radiator fins on surrounding components as it is lifted out.

##### Diesel models

**7** Disconnect the battery negative terminal (refer to *Disconnecting the battery* in the Reference Chapter).

**8** Drain the cooling system as described in Chapter 1B.

**9** Remove the air cleaner assembly and air intake ducts as necessary for access to the radiator, as described in Chapter 4B or 4C.

**10** Slacken the clips and disconnect the upper hoses at the coolant expansion tank (see illustration).

**11** Where applicable, disconnect the wiring

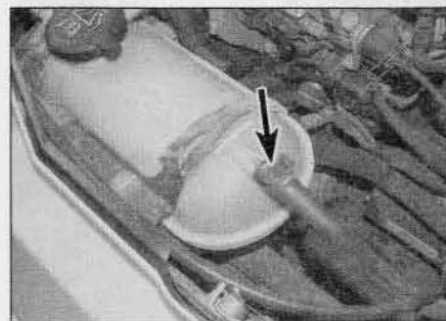

**3.10** Disconnect the upper hoses (left-hand hose arrowed) at the coolant expansion tank on diesel models



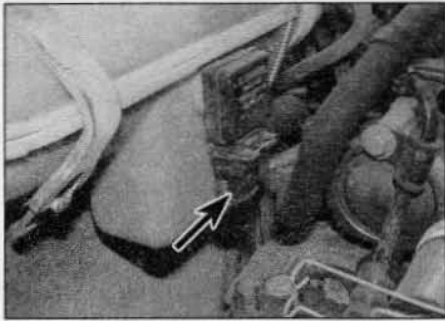

**3.11** Disconnect the wiring connector (arrowed) from the coolant level sensor on the expansion tank

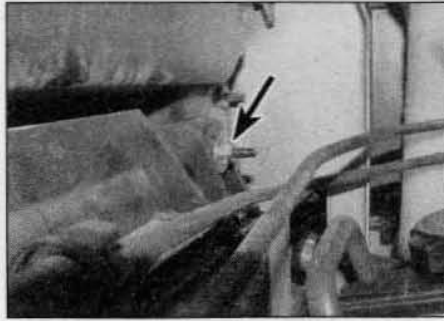

**3.21a** Undo the nut (arrowed) securing the radiator support frame to the front body panel . . .

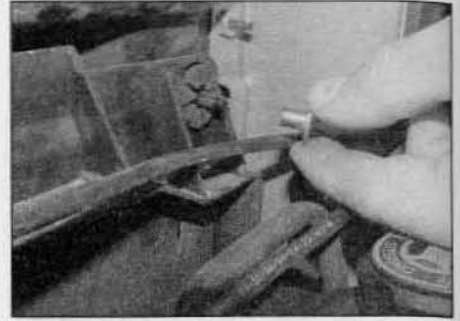

**3.21b** . . . then withdraw the metal spacer from the rubber mounting bush

connector from the coolant level sensor on the rear of the expansion tank (see illustration).

**12** Release the retaining straps and lift the expansion tank off its mounting bracket. Slacken the clip and disconnect the hose from the underside of the expansion tank, then remove the tank.

**13** Remove the radiator grille as described in Chapter 11, then undo the two bolts and remove the expansion tank support bracket from the front body panel.

**14** Where applicable, disconnect the wiring connector from the cooling fan switch or temperature sensor located on the left-hand side of the radiator.

**15** Disconnect all the coolant hoses from the radiator with reference to Section 2.

**16** Working at the top of the radiator, lift the ends of the radiator retaining clips (one each side) and move the top of the radiator toward the engine (see illustration 3.6). Lift the radiator upward to disengage the lower locating lugs and remove the radiator from the engine compartment. Take care not to damage the radiator fins on surrounding components as it is lifted out.

#### Removal – post-September 2002 models

**17** Disconnect the battery negative terminal (refer to *Disconnecting the battery* in the Reference Chapter).

**18** Drain the cooling system as described in Chapter 1A or 1B.

**19** Remove the air cleaner assembly and air intake ducts as necessary for access to the radiator, as described in Chapter 4A, 4B or 4C.

**20** On models without air conditioning, where applicable, disconnect the wiring connector from the cooling fan switch or temperature sensor located on the left-hand side of the radiator.

**21** Working at the top of the radiator, undo the nut (one each side) securing the radiator support frame to the front body panel. Withdraw the metal spacer from the rubber mounting bush (see illustrations).

**22** Move the top of the radiator support frame towards the engine and undo the bolt securing each radiator upper mounting bracket to the frame (see illustration).

**23** Withdraw the brackets from their locations in the support frame, and lift them off the plastic studs on the radiator (see illustration).

**24** Slide out the retaining clips and disconnect the expansion tank hoses from the radiator. Release the hose(s) from the clips on the radiator and move them to one side.

**25** Disconnect the remaining coolant hoses from the radiator with reference to Section 2.

**26** Lift the radiator upward to disengage the lower locating lugs and remove the radiator from the engine compartment. Take care not to damage the radiator fins on surrounding components as it is lifted out.

#### Inspection

**27** If the radiator has been removed due to suspected blockage, reverse-flush it as described in Chapter 1A or 1B. Clean dirt and debris from the radiator fins, using an air line (in which case, wear eye protection) or a soft brush.

**Caution: Be careful, as the fins are sharp, and easily damaged.**

**28** If necessary, a radiator specialist can perform a 'flow test' on the radiator, to establish whether an internal blockage exists.

**29** A leaking radiator must be referred to a specialist for permanent repair. Do not attempt to weld or solder a leaking radiator, as damage to the plastic components may result.

**30** If the radiator is to be sent for repair or renewed, remove all hoses and the cooling fan switch (where fitted).

**31** Inspect the condition of the radiator mounting rubbers, and renew them if necessary.

#### Refitting

**32** Refitting is a reversal of removal, bearing in mind the following points:

- Ensure that the lower lugs on the radiator are correctly engaged with the mounting rubbers in the body panel.
- Reconnect the hoses with reference to Section 2, using new O-rings where applicable.
- On completion, refill the cooling system as described in Chapter 1A or 1B.



**3.22** Undo the bolt securing each radiator upper mounting bracket to the support frame



**3.23** Withdraw the brackets from their locations in the support frame, and lift them off the plastic studs on the radiator

#### 4 Thermostat – removal, testing and refitting

##### Removal

**1** Disconnect the battery negative terminal (refer to *Disconnecting the battery* in the Reference Chapter).

**2** On 1.9 litre DW series diesel engines, release the clip in the centre of the engine cover and undo the retaining screw on the right-hand side. Lift off the engine cover. On 2.0 litre diesel engines, turn the four plastic

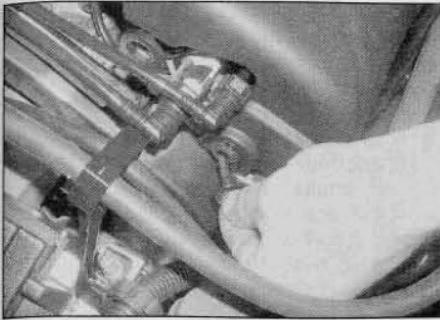

4.2a On 1.9 litre diesel engines, remove the fasteners from the right-hand side ...

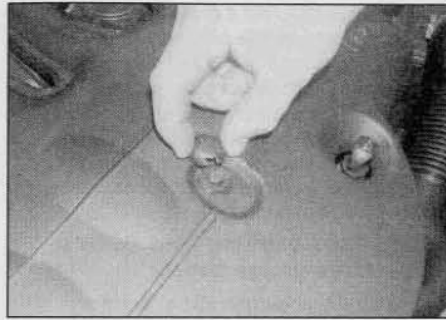

4.2b ... and top of the engine cover ...

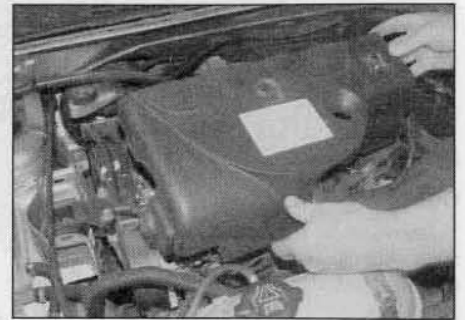

4.2c ... then remove the cover from the engine

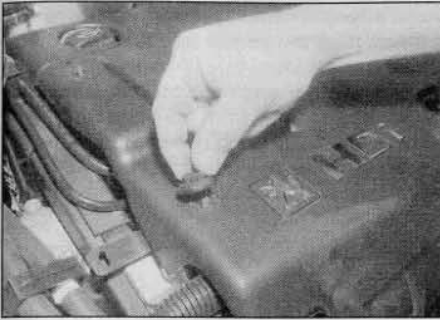

4.2d On 2.0 litre diesel engines, rotate each fastener through 90° to release it ...

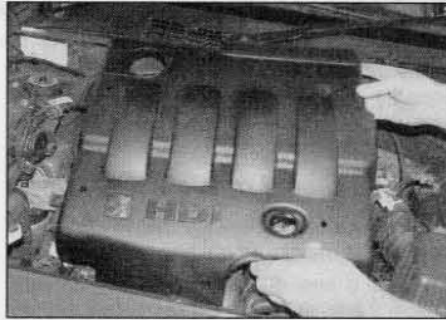

4.2e ... then lift off the engine cover

fasteners through 90° and lift off the engine cover (see illustrations).

3 Drain the cooling system as described in Chapter 1A or 1B.

4 Remove the air cleaner assembly and air intake ducts as described in Chapter 4A, 4B or 4C.

5 Unscrew the retaining bolts, and carefully withdraw the thermostat housing cover to expose the thermostat (see illustration). Take care not to strain the coolant hose(s) connected to the cover. Note that the design of the thermostat housing varies between engine types, but the thermostat removal procedure for each type is similar.

6 On early models with a separate thermostat, lift the thermostat from the housing, noting which way round the

thermostat is fitted, and recover the sealing ring(s) (see illustration).

7 On later models where the thermostat is an integral part of the housing cover, recover the sealing ring, release the retaining clip and remove the cover from the coolant hose.

### Testing

8 A rough test of the thermostat may be made by suspending it with a piece of string in a container full of water. Heat the water to bring it to the boil – the thermostat must open by the time the water boils. If not, renew it.

9 If a thermometer is available, the precise opening temperature of the thermostat may be determined; compare with the figures given in the Specifications. The opening temperature is also marked on the thermostat.

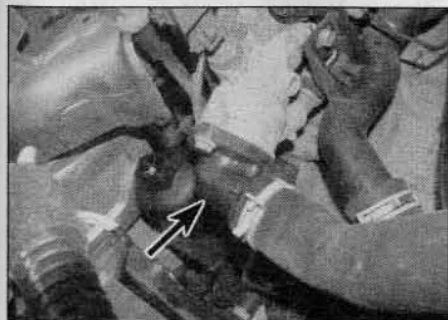

4.5 Thermostat housing cover location (arrowed) – 1.4 litre petrol model

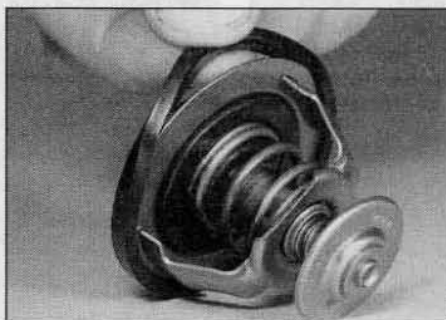

4.6 Removing the sealing ring from the thermostat flange

10 A thermostat which fails to close as the water cools must also be renewed.

### Refitting

11 Refitting is a reversal of removal, bearing in mind the following points:

- Examine the sealing ring(s) for damage or deterioration, and if necessary, renew.
- Ensure that the thermostat is fitted the correct way round as noted during removal.
- On completion, refill the cooling system as described in Chapter 1A or 1B.

### 5 Electric cooling fan(s) – removal and refitting

#### Removal

1 Remove the radiator as described in Section 3.

2 Unscrew the locking ring and disconnect the round wiring connector from the lower left-hand corner of the fan shroud. Where individual connectors are used, trace the wiring back from the fan and disconnect the relevant connectors.

3 On early models, lift the ends of the fan shroud retaining clips (one each side) and move the top of the shroud toward the engine. On all models, lift the assembly upward to disengage the lower locating lugs and remove it from the engine compartment.

4 To remove the fan motor(s) from the shroud, undo the three nuts and bolts securing the relevant motor to the shroud. Withdraw the motor and fan assembly and disconnect the wiring connector. The fan can be removed from the motor spindle after extracting the retaining clip, or undoing the retaining bolt, as applicable.

5 To gain access to the motor relays, unclip and lift off the cover over the relay box located in the centre of the fan shroud. Note that on some models the relay box cover may be secured by a screw.

6 Lift the relay mounting plate from the shroud, disconnect the wiring connector and remove the relevant relay.

#### Refitting

7 Refitting is a reversal of removal. Refit the radiator as described in Section 3.



## 6 Cooling system electrical switches and sensors – removal and refitting



### Petrol models

#### Cooling fan switch – early models

1 On models without air conditioning, the cooling fan switch has a blue wiring connector and is located in the left-hand side of the radiator.

2 On models with air conditioning, the cooling fans are controlled by the air conditioning system control unit in conjunction with a temperature sensor located in the top of the thermostat housing. The sensor can be identified by its brown wiring connector.

#### Temperature warning light switch/temperature gauge sensor

3 The coolant temperature warning light switch/temperature gauge sensor has a blue wiring connector and is located in the thermostat housing or at the left-hand end of the cylinder head.

#### Engine management system coolant temperature sensor

4 The engine management system coolant temperature sensor has a green wiring connector and is located in the thermostat housing.

5 On later engines (approximately 2001 onward) the coolant temperature sensor has a blue or green wiring connector and is located above the thermostat in the coolant outlet housing at the left-hand end of the cylinder head (see illustration). The temperature signal from this sensor is used by the engine management ECU for fuel injection/ignition regulation and to control the operation of the cooling fan, air conditioning system and temperature warning light/gauge.

### 1.8 and 1.9 litre diesel models

#### Cooling fan switch

6 On models without air conditioning, the

cooling fan switch has a blue wiring connector and is located in the left-hand side of the radiator.

7 On models with air conditioning, the cooling fans are controlled by the air conditioning system control unit in conjunction with a temperature sensor located in the thermostat housing. The sensor can be identified by its brown wiring connector.

#### Temperature warning light switch/temperature gauge sensor

8 The coolant temperature warning light switch/temperature gauge sensor has a blue wiring connector and is located in the thermostat housing.

#### Preheating/EGR system coolant temperature switch/sensor

9 The coolant temperature switch or sensor used for control of the preheating and EGR systems has a green wiring connector and is located in the thermostat housing.

### 2.0 litre diesel models

#### Engine management system coolant temperature sensor

10 On 2.0 litre diesel engines the coolant temperature sensor has a green wiring connector and is mounted in the thermostat/coolant outlet housing at the left-hand end of the cylinder head. The temperature signal from this sensor is used by the engine management ECU for diesel injection regulation and to control the operation of the exhaust gas recirculation, cooling fans, pre/post-heating control unit, air conditioning system and temperature warning light/gauge.

### Removal



**Warning:** The engine should be cold before removing a cooling system switch or sensor.

11 Disconnect the battery negative terminal (refer to *Disconnecting the battery* in the Reference Chapter).

12 Partially drain the cooling system to just below the level of the switch/sensor (as described in Chapter 1A or 1B). Alternatively,

have ready a suitable bung to plug the switch aperture in the housing when the switch is removed. If this method is used, take care not to use anything which will allow foreign matter to enter the cooling system.

13 Where necessary, refer to Chapter 4A, 4B or 4C and remove the air cleaner assembly and air intake ducts for access to the switches/sensors located in the thermostat housing or cylinder head.

14 Unplug the wiring connector from the relevant switch/sensor.

15 On later engines fitted with a plastic thermostat/coolant outlet housing, prise out the sensor retaining circlip then remove the sensor and sealing ring from the housing (see illustration). If the system has not been drained, plug the sensor aperture to prevent further coolant loss.

16 On all other engines, carefully unscrew the switch/sensor from its mounting and recover the sealing ring (where applicable). If the system has not been drained, plug the switch/sensor aperture to prevent further coolant loss.

### Refitting

17 On models fitted with a plastic thermostat/coolant outlet housing, fit a new sealing ring to the sensor. Push the sensor firmly into the housing and secure it in position with the circlip, ensuring it is correctly located in the housing groove. Reconnect the sensor wiring connector.

18 On all other engines, if the switch/sensor was originally fitted using sealing compound, clean the switch/sensor threads thoroughly, and coat them with fresh sealing compound. If the switch was originally fitted using a sealing ring, use a new sealing ring on refitting.

19 Fit the switch/sensor to its location, tighten it securely and reconnect the wiring connector.

20 On all engines, refill and bleed the cooling system as described in Chapter 1A or 1B. Follow the bleeding instructions carefully, to ensure that all air is expelled from the cooling system.

21 On completion, refit any components

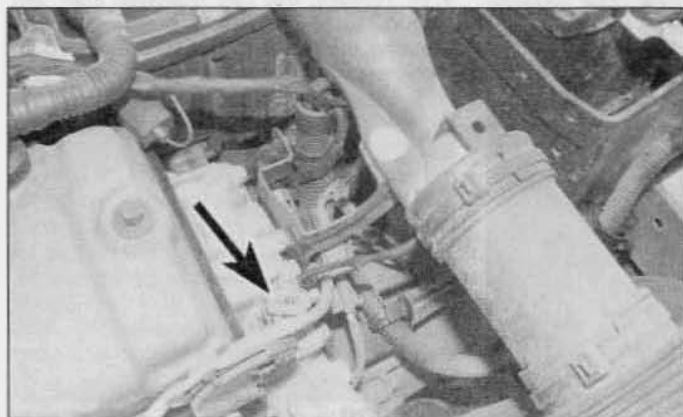

6.5 Engine management system coolant temperature sensor (arrowed) on later 1.4 litre petrol models



6.15 On later models, prise out the sensor retaining circlip then remove the sensor and sealing ring from the housing



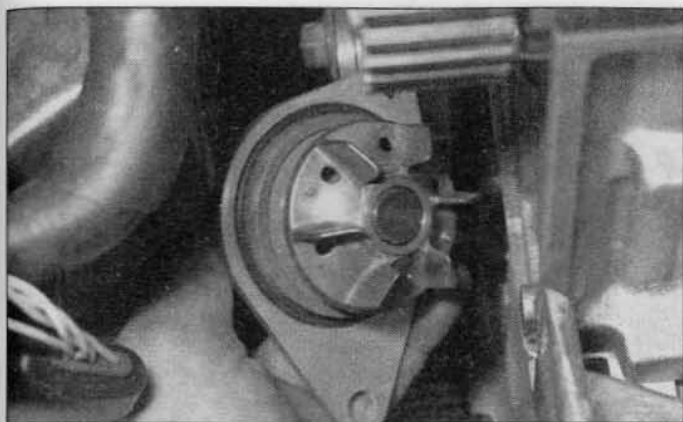

7.4a Withdraw the coolant pump ...

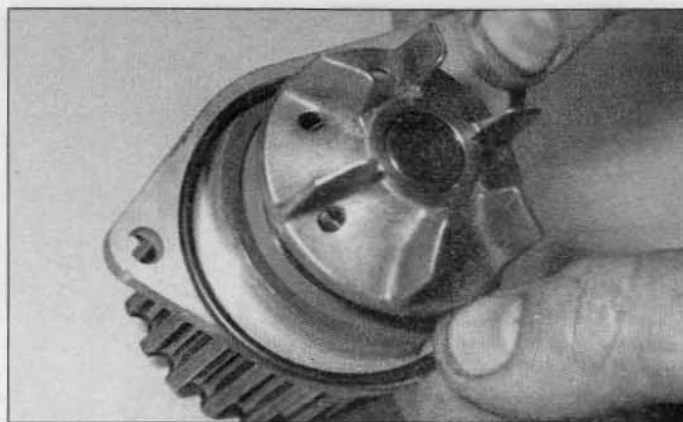

7.4b ... and recover the O-ring - 1.4 litre petrol engine shown

removed for access, then start the engine and run it until it reaches normal operating temperature. Continue to run the engine, and check that the component(s) controlled by the switch/sensor operate correctly.

## 7 Coolant pump - removal and refitting



### Aluminium cylinder block

**Note:** A new impeller assembly O-ring and, where applicable, a new impeller housing O-ring, will be required on refitting.

#### Removal

- 1 The coolant pump is driven by the timing belt, and is located in a housing at the timing belt end of the engine.
- 2 Drain the cooling system as described in the relevant Part of Chapter 1.
- 3 Remove the timing belt as described in the relevant Part of Chapter 2.
- 4 Remove the securing bolts, and withdraw the pump impeller assembly from the pump housing (access is most easily obtained from under the wheel arch). Recover the O-ring (see illustrations).

5 If desired, the pump impeller housing can be removed from the rear of the coolant pump housing. Access is most easily obtained from underneath the vehicle (it may be necessary to remove the exhaust heat shield). Disconnect the coolant hoses from the impeller housing (be prepared for coolant spillage), then remove the securing bolts and withdraw the impeller housing. Again, recover the O-ring.

#### Refitting

- 6 Ensure that all mating faces are clean.
- 7 Where applicable, refit the impeller housing to the rear of the coolant pump housing, using a new O-ring. Reconnect the coolant hoses securely.
- 8 Refit the impeller assembly to the pump housing, using a new O-ring.

9 Refit the timing belt as described in the relevant Part of Chapter 2.

10 Refill the cooling system as described in the relevant Part of Chapter 1.

### Cast-iron cylinder block

**Note:** A new pump O-ring must be used on refitting.

11 The pump is driven by the timing belt, and is located directly in the cylinder block.

12 Proceed as described previously for engines with an aluminium cylinder block, but note that there is no separate impeller housing.

## 8 Thermostat/fuel filter housing (1.8 and 1.9 litre diesel models) - removal and refitting



**Note:** A new gasket must be used when refitting the main housing.

#### Removal

- 1 Disconnect the battery negative terminal (refer to *Disconnecting the battery* in the Reference Chapter).
- 2 Drain the cooling system as described in Chapter 1B.
- 3 Place a plastic sheet over the transmission bellhousing and the starter motor, to prevent any fuel spilled during the following procedure from causing damage.



8.8b ... withdraw the plastic housing ...

4 Remove the fuel filter as described in Chapter 1B.

5 Disconnect the wiring plugs from the coolant sensors mounted in the top of the housing.

6 Disconnect the coolant hoses from the plastic thermostat housing.

7 Disconnect the coolant hose from the stub at the rear of the housing.

8 Unscrew the bolt securing the plastic fuel filter housing to the main housing, then withdraw the plastic housing and move it clear of the main housing. Recover the O-ring from the base of the plastic housing (see illustrations).

9 Unscrew the three securing bolts, and

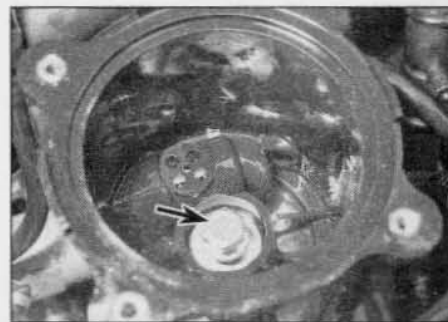

8.8a Unscrew the securing bolt (arrowed) ...

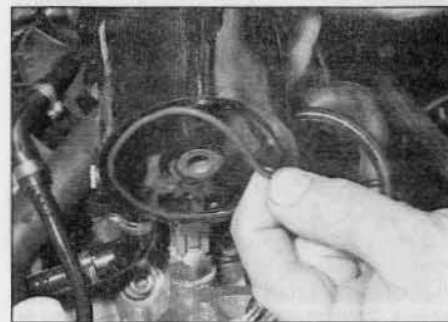

8.8c ... and recover the O-ring

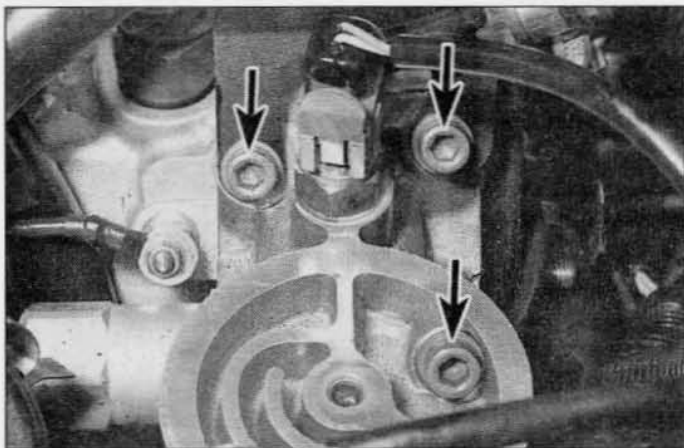

8.9a Unscrew the three securing bolts (arrowed) . . .

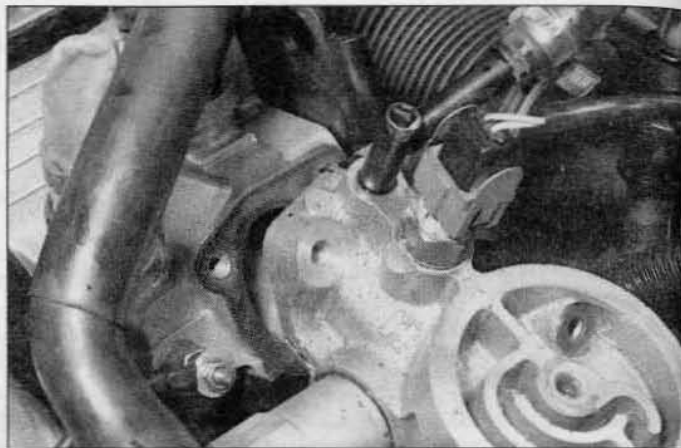

8.9b . . . and withdraw the main thermostat housing

withdraw the main housing from the cylinder head (see illustrations). Recover the gasket.  
**10** Disconnect the coolant hose from the base of the housing, and remove the housing.

**Refitting**

**11** Refitting is a reversal of removal, bearing in mind the following points:

- a) Examine the condition of the O-ring on the base of the plastic housing, and renew if necessary.
- b) Use a new gasket when refitting the main housing.
- c) Ensure that all hoses, pipes and wires are correctly reconnected.
- d) Refill the cooling system as described in Chapter 1B.
- e) On completion, prime and bleed the fuel system as described in Chapter 4B or 4C.

**9 Heating and ventilation system – general information**

The heating/ventilation system consists of a four-speed blower motor (housed behind the facia), face level vents in the centre and at each end of the facia, and air ducts to the front footwells.

The control unit is located in the facia, and the controls operate flap valves to deflect and mix the air flowing through the various parts of the heating/ventilation system. The flap valves are contained in the air distribution housing, which acts as a central distribution unit, passing air to the various ducts and vents.

Cold air enters the system through the grille at the rear of the engine compartment. If required, the airflow is boosted by the blower, and then flows through the various ducts, according to the settings of the controls. Stale air is expelled through ducts at the rear of the vehicle. If warm air is required, the cold air is passed over the heater matrix, which is heated by the engine coolant.

On models fitted with air conditioning, a recirculation switch enables the outside air supply to be closed off, while the air inside the vehicle is recirculated. This can be useful to prevent unpleasant odours entering from outside the vehicle, but should only be used briefly, as the recirculated air inside the vehicle will soon become stale.

**10 Heater/ventilation components – removal and refitting**

**Heater/ventilation control unit.**

**Removal**

- 1** Disconnect the battery negative terminal (refer to *Disconnecting the battery* in the Reference Chapter).
- 2** Remove the relevant panels in the centre of the facia, for access to the control unit, as described in Chapter 11.
- 3** Undo the two upper retaining screws at each corner of the control unit.
- 4** Using a small screwdriver, release the retaining lug at the lower centre of the control unit and withdraw the unit from the facia (see illustration).



**10.4** Release the lug at the lower centre of the heater/ventilation control unit and withdraw the unit from the facia

- 5** Pivot the control unit upwards, as far as clearance will allow, then release the securing clips and disconnect the control cables from the unit. Note the locations of the cables to ensure correct refitting (see illustration).
- 6** Disconnect the wiring plug from the rear of the control unit, then withdraw the unit.

**Refitting**

**7** Refitting is a reversal of removal, but ensure that the control cables are securely reconnected to their original locations.

**Heater/ventilation control cables**

**Removal**

- 8** Disconnect the cables from the heater/ventilation control unit, as described previously in this Section during the control unit removal procedure.
- 9** Working through the facia aperture or under the facia (it may be necessary to remove certain facia panels for access – see Chapter 11 – depending on which cable is to be removed), release the clips and disconnect the cable from the heater assembly. Note the routing of the cable to ensure correct refitting.

**Refitting**

**10** Refitting is a reversal of removal, ensuring that the cables are correctly routed, and securely reconnected.

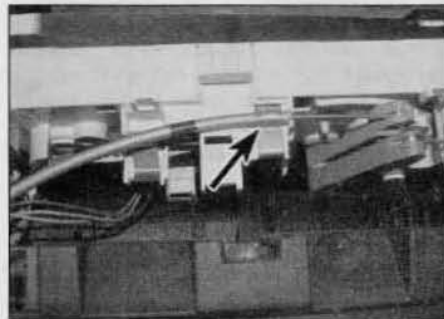

**10.5** Pivot the control unit upwards, then release the clips (arrowed) and disconnect the control cables



## Heater matrix

**Note 1:** New heater hose connector O-rings must be used on refitting.

**Note 2:** The design, layout and construction of the heater assembly varies considerably according to model type, engine type and year of manufacture. The following procedures describe a typical installation.

### Removal

**11** Drain the cooling system (see Chapter 1A or 1B).

**12** Remove the complete fascia assembly as described in Chapter 11.

**13** Working in the engine compartment, disconnect the heater hoses from the matrix pipes. Where the hoses are connected individually, release the retaining clips and disconnect the hoses from the heater matrix pipe unions on the engine compartment bulkhead. Where the hoses are connected to a block connector, prise the metal retaining clip from the top of the connector, then release the plastic retaining clip by pushing it towards the left-hand hose connection. Pull the connector assembly from the heater matrix. Recover the O-ring seals from the connector, and discard them; new ones should be used on refitting (see illustrations).

**14** Undo the two screws securing the cover plate over the matrix pipes bulkhead seal. Lift off the cover plate, noting the orientation of the D-shaped cut-out.

**15** Withdraw the rubber bulkhead seal from the matrix pipes.

**16** Working inside the car, disconnect and withdraw the ventilation ducts on the driver's and passenger's side.

**17** Unscrew the bolt securing the bottom of the heater to the bracket on the floor (see illustration).

**18** Check that all cables, wiring and related components are disconnected or moved clear to allow the heater assembly to be withdrawn into the vehicle interior.

**19** Again working in the engine compartment, unscrew the two nuts securing the heater assembly to the bulkhead.

**20** With the aid of an assistant working in the engine compartment, ease the matrix pipes



**10.13a** Where the heater hoses are connected individually, prise out the retaining clip and disconnect the hoses from the matrix pipe unions

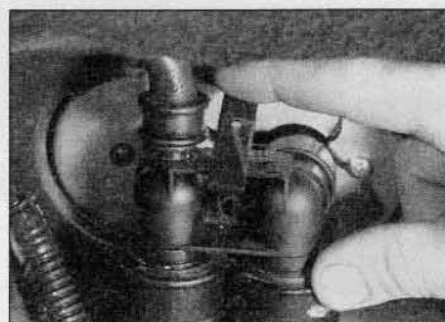

**10.13b** Where the hoses are connected to a block connector, remove the metal clip from the heater matrix connector . . .



**10.13c** . . . then release the plastic retaining clip . . .

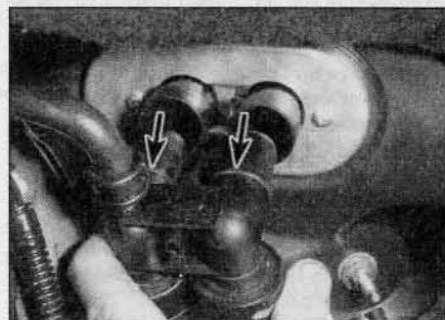

**10.13d** . . . and pull the connector away from the bulkhead - recover the O-rings (arrowed)

from the bulkhead, and carefully pull the heater assembly into the vehicle interior.

**21** With the heater assembly removed, release the four securing clips, then withdraw the matrix from the heater casing (see illustration).

### Refitting

**22** Refitting is a reversal of removal bearing in mind the following points.

- Before refitting the heater assembly, lubricate the heater pipe grommet, then refit it to the matrix pipes.
- Offer the heater assembly into position, pushing the heater pipe grommet through the bulkhead as the assembly is refitted (again, an assistant working in the engine compartment will ease the task).
- When reconnecting the heater hoses to

the pipes, fit new O-rings to the matrix pipes, then reconnect the hose connector to the pipes.

## Heater blower motor

### Removal

**23** The blower motor assembly is located on the passenger side of the vehicle.

**24** Disconnect the battery negative terminal (refer to *Disconnecting the battery* in the Reference Chapter).

**25** Referring to Chapter 11, remove the fascia panels as necessary for access under the fascia on the passenger's side.

**26** Unscrew the screws securing the motor assembly to the heater unit and lower the motor from its location (see illustration).

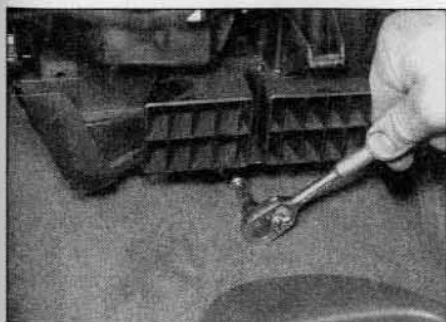

**10.17** Unscrew the bolt securing the bottom of the heater to the bracket on the floor

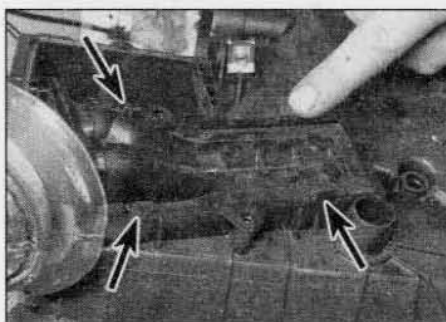

**10.21** Release the four securing clips (arrowed) then withdraw the matrix from the heater casing

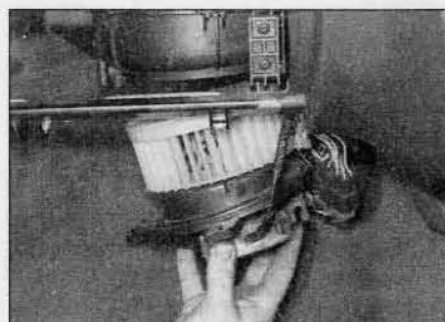

**10.26** Unscrew the screws securing the motor assembly to the heater unit and lower the motor from its location



27 Cut the cable tie securing the wiring to the motor cover then pull the rubber wiring grommet away, and disconnect the wiring connector.

**Refitting**

28 Refitting is a reversal of removal.

**11 Air conditioning system – general information and precautions**

**General information**

An air conditioning system is available on certain models. It enables the temperature of incoming air to be lowered, and also dehumidifies the air, which makes for rapid demisting and increased comfort.

The cooling side of the system works in the same way as a domestic refrigerator. Refrigerant gas is drawn into a belt-driven compressor, and passes into a condenser mounted on the front of the radiator, where it loses heat and becomes liquid. The liquid passes through an expansion valve to an evaporator, where it changes from liquid under high pressure to gas under low pressure. This change is accompanied by a drop in temperature, which cools the evaporator. The refrigerant returns to the compressor, and the cycle begins again.

Air blown through the evaporator passes to the air distribution unit, where it is mixed with hot air blown through the heater matrix to achieve the desired temperature in the passenger compartment.

The heating side of the system works in the same way as on models without air conditioning (see Section 9).

The operation of the system is controlled by an electronic control unit, which controls the electric cooling fan(s), the compressor and the fascia-mounted warning light. Any problems with the system should be referred to a Peugeot/Citroën dealer (see Tool tip).

**Precautions**

When an air conditioning system is fitted, it is necessary to observe special precautions whenever dealing with any part of the system, or its associated components. If for any reason the system must be disconnected, entrust this task to your Peugeot/Citroën dealer or a refrigeration engineer.



**Warning:** The refrigeration circuit contains a liquid refrigerant, and it is therefore dangerous to disconnect any part of the system without specialised knowledge and equipment.

The refrigerant is potentially dangerous, and should only be handled by qualified persons. If it is splashed onto the skin, it can cause frostbite. It is not itself poisonous, but in the presence of a naked flame (including a cigarette) it forms a poisonous gas. Uncontrolled discharging of the refrigerant is dangerous, and potentially damaging to the environment.

**12 Air conditioning system components – removal and refitting**



**Note:** Do not operate the air conditioning system if it is known to be short of refrigerant, as this may damage the compressor.

1 The only operation which can be carried out

**TOOL TIP**



Many car accessory shops sell one-shot air conditioning recharge aerosols. These generally contain refrigerant, compressor oil, leak sealer and system conditioner. Some also have a dye to help pinpoint leaks.



**Warning:** These products must only be used as directed by the manufacturer, and do not remove the need for regular maintenance.

easily without discharging the refrigerant is the renewal of the auxiliary (compressor) drivebelt. This is described in the relevant Part of Chapter 1. All other operations must be referred to a Peugeot/Citroën dealer or an air conditioning specialist.

2 If necessary, the compressor can be unbolted and moved aside, without disconnecting its flexible hoses, after removing the drivebelt.



**Warning:** Do not attempt to open the refrigerant circuit. Refer to the precautions given in Section 11.

# Chapter 4 Part A:

## Fuel and exhaust systems – petrol models

### Contents

	Section number	Section number	
Accelerator cable – removal, refitting and adjustment .....	3	Fuel filter – renewal .....	See Chapter 1A
Accelerator pedal – removal and refitting .....	4	Fuel gauge sender unit – removal and refitting .....	9
Air cleaner assembly and intake ducts – removal and refitting .....	2	Fuel pump – removal and refitting .....	8
Air cleaner filter element renewal .....	See Chapter 1A	Fuel system – depressurisation and pressurising .....	7
Engine management system – general information .....	6	Fuel tank – removal and refitting .....	10
Engine management system – testing and adjustment .....	11	General information and precautions .....	1
Engine management system components – removal and refitting ..	13	Inlet manifold – removal and refitting .....	14
Exhaust manifold – removal and refitting .....	15	Throttle housing – removal and refitting .....	12
Exhaust system – general information, removal and refitting .....	16	Unleaded petrol – general information and usage .....	5

### Degrees of difficulty

**Easy**, suitable for novice with little experience



**Fairly easy**, suitable for beginner with some experience



**Fairly difficult**, suitable for competent DIY mechanic



**Difficult**, suitable for experienced DIY mechanic



**Very difficult**, suitable for expert DIY or professional



### Specifications

#### System type

##### 1.4 litre models:

##### Engine code KFX:

Pre-1999 models .....

Magneti Marelli 1AP

1999 models onward:

To emission standard L3 .....

Sagem Lucas SL96

To emission standard L4 .....

Bosch Motronic MP7.3

##### Engine code KFW .....

Sagem S2000

##### 1.6 litre models .....

Bosch Motronic ME7.4.4

#### Fuel system data

Fuel pump type .....

Electric, immersed in tank

Specified idle speed .....

850 ± 50 rpm (not adjustable – controlled by ECU)

Idle mixture CO content .....

Less than 1.0 % (not adjustable – controlled by ECU)

#### Recommended fuel

Minimum octane rating .....

95 RON unleaded

#### Torque wrench settings

Exhaust manifold-to-cylinder head nuts .....

**Nm**

**lbf ft**

20

15

Inlet manifold nuts:

M6 .....

10

7

M8 .....

20

15

#### 1 General information and precautions

The fuel supply system consists of a fuel tank (which is mounted under the rear of the car, with an electric fuel pump immersed in it), a fuel filter, fuel feed lines and, on early models, fuel return lines. The fuel pump

supplies fuel to the fuel rail, which acts as a reservoir for the four fuel injectors which inject fuel into the inlet tracts. The fuel filter incorporated in the feed line from the pump to the fuel rail ensures that the fuel supplied to the injectors is clean.

Refer to Section 6 for further information on the operation of each engine management system, and to Section 16 for information on the exhaust system.



**Warning:** Many of the procedures in this Chapter require the removal of fuel lines and connections, which may result in some fuel spillage. Before carrying out any operation on the fuel system, refer to the precautions given in 'Safety first!' at the beginning of this manual, and follow them implicitly. Petrol is a highly dangerous and volatile liquid, and the

*precautions necessary when handling it cannot be overstressed.*

**Note:** Residual pressure will remain in the fuel lines long after the vehicle was last used. When disconnecting any fuel line, first depressurise the fuel system as described in Section 7.

**2 Air cleaner assembly and intake ducts – removal and refitting**

**Note:** Where crimped-type hose clips or ties are fitted, cut and discard them and use standard worm-drive hose clips, or new cable ties on refitting.

**Removal**

**Pre-September 2002 1.4 litre models**

- 1 Slacken the retaining clip securing the air cleaner lid to the throttle housing (see illustration).
- 2 Disconnect the breather hose at the front of the air cleaner lid by slackening the retaining clip (where fitted) or depressing the sides of the quick-release fitting.
- 3 Undo the bolt securing the air intake duct to the support bracket on the engine, and the two screws securing the intake duct to the front body panel (see illustration).
- 4 Detach the air cleaner lid from the throttle housing, while at the same time lifting the air cleaner housing upwards to release the lower

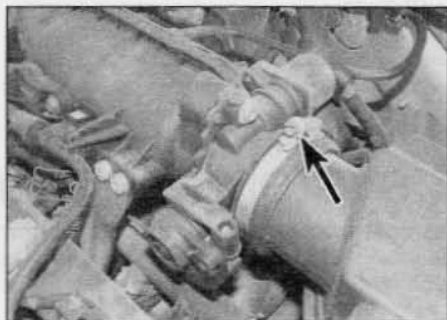

**2.1 Slacken the retaining clip (arrowed) securing the air cleaner lid to the throttle housing – early 1.4 litre models**

mounting. Slide the unit sideways slightly and withdraw it, together with the intake duct, from the engine compartment. Recover the throttle housing sealing ring from the air cleaner lid.

5 If required, the intake duct components can be separated after cutting off the retaining cable ties.

**1.6 litre models and post-September 2002 1.4 litre models**

- 6 Slacken the clip securing the air cleaner lid to the throttle housing (see illustration).
- 7 Depress the sides of the quick-release fitting and detach the engine breather hose from the air cleaner lid (see illustration).
- 8 Undo the nut securing the air intake duct to the front body panel (see illustration). Lift the



**2.3 Undo the bolt (arrowed) securing the air intake duct to the support bracket – early 1.4 litre models**

duct off the mounting stud and slide it sideways slightly to disengage the additional retaining tab.

9 Release the plastic retainer securing the air cleaner housing to the support bracket by turning it through 90° (see illustration).

10 Detach the air cleaner lid from the throttle housing, while at the same time lifting the air cleaner housing upwards to release the lower mounting. Slide the unit sideways slightly and withdraw it, together with the intake duct, from the engine compartment (see illustrations). Recover the throttle housing sealing ring from the air cleaner lid.

11 If required, the intake duct can be removed from the air cleaner housing by pulling it outwards from the base of the housing.



**2.6 Slacken the clip securing the air cleaner lid to the throttle housing – later models**



**2.7 Depress the quick-release fitting and detach the breather hose from the air cleaner lid**



**2.8 Undo the nut (arrowed) securing the air intake duct to the front body panel – later models**

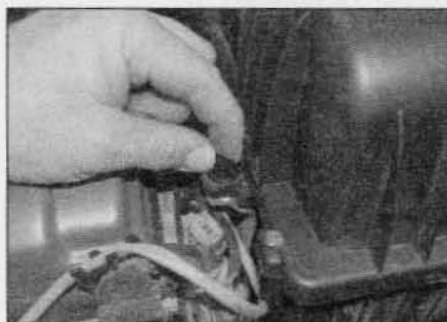

**2.9 Turn the plastic retainer through 90° to release it – later models**



**2.10a Detach the air cleaner lid from the throttle housing . . .**



**2.10b . . . then lift the air cleaner assembly upwards to release the lower mounting – later models**



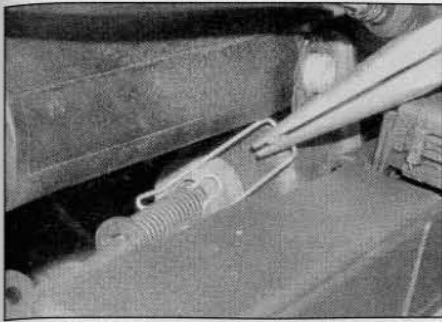

**3.1 Remove the spring clip from the accelerator outer cable**

### Refitting

**12** Refitting is a reversal of the removal procedure, ensuring that all hoses are properly reconnected, and that all ducts are correctly seated and securely held by their retaining clips or cable ties.

## 3 Accelerator cable – removal, refitting and adjustment

### Removal

**1** Working in the engine compartment, free the accelerator inner cable from the throttle housing cam, or accelerator pedal position sensor, then pull the outer cable out from its mounting bracket rubber grommet. Recover the spring clip from the outer cable (see illustration).

**2** Working back along the length of the cable, free it from any retaining clips or ties, noting its correct routing.

**3** Working inside the car, remove the fusebox cover and the under cover from beneath the fascia on the driver's side.

**4** Reach up under the fascia, depress the ends of the cable end fitting and detach the inner cable from the top of the accelerator pedal. Where fitted, pull out the clip securing the bulkhead grommet.

**5** Tie a length of string to the end of the cable.

**6** Return to the engine compartment, release the cable grommet from the bulkhead and withdraw the cable. When the end of the cable appears, untie the string and leave it in position – it can then be used to draw the cable back into position on refitting.

### Refitting

**7** Tie the string to the end of the cable, then use the string to draw the cable into position through the bulkhead. Once the cable end is visible, untie the string, then attach the inner cable to the pedal. Where applicable, refit the bulkhead grommet clip.

**8** From within the engine compartment, ensure the outer cable is correctly seated in the bulkhead grommet, then work along the cable, securing it in position with the retaining

clips and ties, and ensuring that the cable is correctly routed.

**9** Pass the outer cable through its mounting bracket grommet, and reconnect the inner cable to the throttle cam or accelerator pedal position sensor. Adjust the cable as described below.

### Adjustment

**10** Remove the spring clip from the accelerator outer cable (see illustration 3.1). Ensuring that the throttle cam or position sensor is fully against its stop, gently pull the cable out of its grommet until all free play is removed from the inner cable.

**11** With the cable held in this position, refit the spring clip to the last exposed outer cable groove in front of the rubber grommet. When the clip is refitted and the outer cable is released, there should be only a small amount of free play in the inner cable.

**12** Have an assistant depress the accelerator pedal, and check that the throttle cam or position sensor opens fully and returns smoothly to its stop.

## 4 Accelerator pedal – removal and refitting

### Removal

**1** Detach the accelerator cable from the pedal as described in the previous Section.

#### Right-hand drive models

**2** Unscrew the nut from the end of the pedal pivot shaft, whilst retaining the pivot shaft with an open-ended spanner on the flats provided.

**3** Withdraw the pedal and pivot shaft assembly from the support bracket.

**4** Examine the pivot shaft for signs of wear or damage and, if necessary, renew it. The pivot shaft is a screw fit in the pedal.

#### Left-hand drive models

**5** Unscrew the two nuts and lift off the pedal pivot housing cover and upper bearing.

**6** Withdraw the pedal from the lower bearing.

**7** Examine the pivot bushes and shaft for signs of wear and renew as necessary.

### Refitting

**8** Refitting is a reversal of the removal procedure, applying a little multi-purpose grease to the pedal pivot point. On completion, adjust the accelerator cable as described in Section 3.

## 5 Unleaded petrol – general information and usage

**Note:** The information given in this Chapter is correct at the time of writing. If updated information is thought to be required, check with a Peugeot/Citroën dealer. If travelling

abroad, consult one of the motoring organisations (or a similar authority) for advice on the fuel available.

**1** All petrol engine models covered by this manual are designed to run on unleaded fuel with a minimum octane rating of 95 (RON). All engines have a catalytic converter, and so must be run on unleaded fuel **only**. Under no circumstances should leaded fuel, or lead replacement petrol (LRP) be used, as this will damage the converter.

**2** Super unleaded petrol (98 octane) can also be used in all models if wished, though there is no advantage in doing so.

## 6 Engine management system – general information

**Note:** The fuel injection ECU is of the 'self-learning' type, meaning that as it operates, it also monitors and stores the settings which give optimum engine performance under all operating conditions. When the battery is disconnected, these settings are lost and the ECU reverts to the base settings programmed into its memory at the factory. On restarting, this may lead to the engine running/idling roughly for a short while, until the ECU has released the optimum settings. This process is best accomplished by taking the vehicle on a road test (for approximately 15 minutes), covering all engine speeds and loads, concentrating mainly in the 2500 to 3500 rpm region.

On all models, the fuel injection and ignition functions are combined into a single engine management system. The systems fitted are manufactured by Bosch, Magneti Marelli and Sagem, and are very similar to each other in most respects, the only significant differences being in the software contained in the system ECU, and specific component location according to engine type. Each system incorporates a closed-loop catalytic converter and an evaporative emission control system, and complies with the latest emission control standards. Refer to Chapter 5B for information on the ignition side of each system; the fuel side of the system operates as follows.

The fuel pump supplies fuel from the tank to the fuel rail, via a renewable cartridge filter mounted on the side of the fuel tank. The pump itself is mounted inside the tank, with the pump motor permanently immersed in fuel, to keep it cool. The fuel rail is mounted directly above the fuel injectors and acts as a fuel reservoir.

Fuel rail supply pressure is controlled by the pressure regulator, mounted at the end of the fuel rail, on the fuel tank, or integrated into the fuel pump assembly. The regulator contains a spring-loaded valve, which lifts to allow excess fuel to return to the tank when the optimum operating pressure of the fuel system is exceeded (eg, during low speed, light load cruising).

The fuel injectors are electromagnetic pintle valves, which spray atomised fuel into the combustion chambers under the control of the engine management system ECU. There are four injectors, one per cylinder, mounted in the inlet manifold close to the cylinder head. Each injector is mounted at an angle that allows it to spray fuel directly onto the back of the inlet valve(s). The ECU controls the volume of fuel injected by varying the length of time for which each injector is held open.

The electrical control system consists of the ECU, along with the following sensors:

- a) *Throttle potentiometer* – informs the ECU of the throttle valve position, and the rate of throttle opening/closing.
- b) *Coolant temperature sensor* – informs the ECU of engine temperature.
- c) *Inlet air temperature sensor* – informs the ECU of the temperature of the air passing through the throttle housing.
- d) *Lambda (oxygen) sensors* – inform the ECU of the oxygen content of the exhaust gases (explained in greater detail in Part D of this Chapter).
- e) *Manifold pressure sensor* – informs the ECU of the load on the engine (expressed in terms of inlet manifold vacuum).
- f) *Crankshaft position sensor* – informs the ECU of engine speed and crankshaft angular position.
- g) *Vehicle speed sensor* – informs the ECU of the vehicle speed.
- h) *Knock sensor* – informs the ECU of pre-ignition (detonation) within the cylinders.
- i) *Camshaft sensor (Motronic MP7.3)* – informs the ECU of which cylinder is on the firing stroke.
- j) *Accelerator pedal position sensor (Sagem S2000 and Motronic ME7.4.4)* – informs the ECU of the pedal position and rate of change.
- k) *Accelerometer sensor (Motronic MP7.3)* – informs the ECU of the quality of the road surface on which the vehicle is being driven. This ensures the ECU does not diagnose variations in engine speed due to an uneven road surface as an ignition misfire.

Signals from each of the sensors are compared by the ECU and, based on this information, the ECU selects the response appropriate to those values, and controls the fuel injectors (varying the pulse width – the length of time the injectors are held open – to provide a richer or weaker air/fuel mixture, as appropriate). The air/fuel mixture is constantly varied by the ECU, to provide the best settings for cranking, starting (with either a hot or cold engine) and engine warm-up, idle, cruising and acceleration.

The ECU also has full control over the engine idle speed, via a stepper motor fitted to the throttle housing. The stepper motor either controls the amount of air passing through a bypass drilling at the side of the throttle or controls the position of the throttle valve itself, depending on model. On Sagem

S2000 and Motronic ME7.4.4 systems, a sensor informs the ECU of the position, and rate of change, of the accelerator pedal. The ECU then controls the throttle valve by means of a throttle positioning motor integral with the throttle body. The ECU also carries out 'fine tuning' of the idle speed by varying the ignition timing to increase or reduce the torque of the engine as it idling. This helps to stabilise the idle speed when electrical or mechanical loads (such as headlights, air conditioning, etc) are switched on and off.

The throttle housing may also be fitted with an electric heating element. The heater is supplied with current by the ECU, warming the throttle housing on cold starts to help prevent icing of the throttle valve.

The exhaust and evaporative loss emission control systems are described in more detail in Chapter 4D.

If there is any abnormality in any of the readings obtained from the coolant temperature sensor, the inlet air temperature sensor or the lambda sensor, the ECU enters its 'back-up' mode. If this happens, the erroneous sensor signal is overridden, and the ECU assumes a pre-programmed 'back-up' value, which will allow the engine to continue running, albeit at reduced efficiency. If the ECU enters this mode, the warning lamp on the instrument panel will be illuminated, and the relevant fault code will be stored in the ECU memory.

If the warning light illuminates, the vehicle should be taken to a Peugeot/Citroën dealer or engine diagnostic specialist at the earliest opportunity. Once there, a complete test of the engine management system can be carried out, using a special electronic diagnostic test unit, which is plugged into the system's diagnostic connector located adjacent to the passenger's compartment fusebox.

## 7 Fuel system – depressurisation and pressurising

**Note:** Refer to the warning note in Section 1 before proceeding.

### Depressurisation

**Warning:** The following procedure will merely relieve the pressure in the fuel system – remember that fuel will still be present in the system components and take precautions accordingly before disconnecting any of them.

1 The fuel system referred to in this Section is defined as the tank-mounted fuel pump, the fuel filter, the fuel injectors, the fuel rail and the pipes of the fuel lines between these components. All these contain fuel which will be under pressure while the engine is running, and/or while the ignition is switched on. The pressure will remain for some time after the

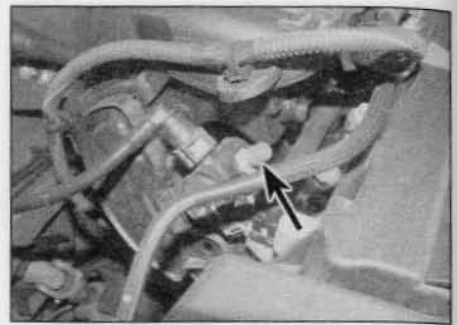

7.3 Fuel rail pressure relief valve (arrowed) – 1.6 litre model shown

ignition has been switched off, and must be relieved in a controlled fashion when any of these components are disturbed for servicing work.

2 Disconnect the battery negative terminal (refer to *Disconnecting the battery* in the Reference Chapter).

3 Some models are equipped with a pressure relief valve on the fuel rail (see illustration). On these models, unscrew the cap from the valve and position a container beneath the valve. Hold a wad of rag over the valve and relieve the pressure in the system by depressing the valve core with a suitable screwdriver. Be prepared for the squirt of fuel as the valve core is depressed and catch it with the rag. Hold the valve core down until no more fuel is expelled from the valve. Once the pressure is relieved, securely refit the valve cap.

4 Where no valve is fitted to the fuel rail, it will be necessary to release the pressure as a fuel pipe is disconnected. Place a container beneath the union and position a large rag around the union to catch any fuel spray which may be expelled. Slowly release and disconnect the fuel pipe and catch any spilt fuel in the container. Plug the pipe/union to minimise fuel loss and prevent the entry of dirt into the fuel system.

### Pressurising

5 After any work is carried out on the fuel system, the system should be pressurised as follows.

6 Depress the accelerator pedal fully then switch on the ignition. Hold the pedal depressed for approximately 1 second then release it. The ECU should then operate the fuel pump for between 20 and 30 seconds to refill the fuel system. Once the fuel pump stops the ignition can be switched off.

## 8 Fuel pump – removal and refitting

### Removal

1 Remove the fuel tank as described in Section 10.  
2 Depress the retaining tabs on the quick-release fitting(s) and disconnect the fuel



pipe(s) from the top of the pump. Plug the pipe end(s) to prevent the entry of dirt.

**3** Check to see if alignment marks are present on the tank, pump cover and the locking ring. If no marks are visible, make your own marks using quick-drying paint such as correction fluid.

**4** Unscrew the locking ring and remove it from the tank. This is best accomplished by using a screwdriver on the raised ribs of the locking ring. Carefully tap the screwdriver to turn the ring anti-clockwise until it can be unscrewed by hand. Alternatively, a Peugeot/Citroën special tool is available which fits over the collar and allows it to be released using a ratchet and extension.

**5** Carefully lift the fuel pump assembly out of the fuel tank, taking great care not to damage the fuel gauge sender unit float arm. Recover the rubber sealing ring and discard it – a new one must be used on refitting.

**6** Note that the fuel pump is only available as a complete assembly – no components are available separately.

### Refitting

**7** Fit the new sealing ring to the top of the fuel tank.

**8** Carefully manoeuvre the pump assembly into the fuel tank, taking care not to damage the float arm.

**9** Position the pump so that the marks on the pump and tank, or made prior to removal are aligned. On some pump types, a notch in the pump body engages with a cut-out in the tank to ensure correct alignment.

**10** Refit the locking ring and tighten it securely until its alignment mark aligns with the mark on the pump.

**11** Reconnect the fuel pipe(s) to the pump, then refit the fuel tank as described in Section 10.

### 9 Fuel gauge sender unit – removal and refitting

The fuel gauge sender unit is an integral part of the fuel pump assembly and is not available separately. Refer to Section 8 for removal and refitting details.

### 10 Fuel tank – removal and refitting

**Note:** Refer to the warning note in Section 1 before proceeding.

### Removal

**1** Before removing the fuel tank, all fuel must be drained from the tank. Since a fuel tank drain plug is not provided, it is therefore preferable to carry out the removal operation

when the tank is nearly empty. Before proceeding, disconnect the battery negative terminal (refer to *Disconnecting the battery* in the Reference Chapter), and syphon or hand-pump the remaining fuel from the tank.

**2** Chock the front wheels then jack up the rear of the car and securely support it on axle stands (see *Jacking and vehicle support*).

**3** Remove the exhaust system heat shield from the base of the fuel tank as described in Section 16.

**4** Working at the right-hand side of the fuel tank, release the retaining clips then disconnect the filler neck vent pipe and main filler neck hose from the fuel tank. Similarly, disconnect the breather and vent hoses at their connections on the right-hand side of the tank.

**5** Disconnect the accessible fuel feed and, where applicable, return hoses at the quick-release fittings on the fuel filter and on the hoses themselves. Bear in mind the information given in Section 7 on depressurising the fuel system when disconnecting the fuel pipes. Plug the pipe ends to minimise fuel loss and prevent the entry of dirt.

**6** Disconnect the fuel pump wiring at the connector adjacent to the fuel filter.

**7** Release the two handbrake cables from their guides on the underside of the fuel tank.

**8** Place a trolley jack with an interposed block of wood beneath the tank, then raise the jack until it is supporting the weight of the tank.

**9** Slacken and remove the two retaining bolts, then remove the support brace from the underside of the tank.

**10** Undo and remove the two additional retaining bolts, one on each side of the tank.

**11** Slowly lower the fuel tank from its location, until there is sufficient clearance available to disconnect the remaining fuel and vent pipes from the tank.

**12** Position the right-hand handbrake cable over the top of the tank, lower the jack slightly and withdraw the tank from the right-hand side of the vehicle.

**13** If the tank is contaminated with sediment or water, remove the fuel pump as described in Section 8, and swill the tank out with clean fuel. The tank is injection-moulded from a synthetic material – if seriously damaged, it should be renewed. However, in certain cases, it may be possible to have small leaks or minor damage repaired. Seek the advice of a specialist before attempting to repair the fuel tank.

### Refitting

**14** Refitting is the reverse of the removal procedure, noting the following points:

- a) When manoeuvring the tank back into position, take care to ensure that none of the hoses become trapped between the tank and vehicle body.
- b) Ensure all pipes and hoses are correctly routed, and securely held in position with their retaining clips.

c) On completion, refill the tank with a small amount of fuel, and check for signs of leakage prior to taking the vehicle out on the road.

## 11 Engine management system – testing and adjustment

### Testing

**1** If a fault appears in the engine management system, first ensure that all the system wiring connectors are securely connected and free of corrosion. Ensure that the fault is not due to poor maintenance; ie, check that the air cleaner filter element is clean, the spark plugs are in good condition and correctly gapped, the cylinder compression pressures are correct and that the engine breather hoses are clear and undamaged, referring to Chapters 1A, 2A and 5B for further information.

**2** If these checks fail to reveal the cause of the problem, the vehicle should be taken to a suitably-equipped Peugeot/Citroën dealer or engine management diagnostic specialist for testing. A diagnostic socket is located adjacent to the passenger's compartment fusebox, to which a fault code reader or other suitable test equipment can be connected (see illustration). By using the code reader or test equipment, the engine management ECU (and the various other vehicle system ECUs) can be interrogated, and any stored fault codes can be retrieved. This will allow the fault to be quickly and simply traced, alleviating the need to test all the system components individually, which is a time-consuming operation that carries a risk of damaging the ECU.

### Adjustment

**3** Whilst it is possible to check the exhaust CO level and the idle speed, if these are found to be in need of adjustment, the car *must* be taken to a suitably-equipped dealer or specialist or further testing. Neither the mixture adjustment (exhaust gas CO level) nor the idle speed are adjustable, and should either be incorrect, a fault must be present in the engine management system.

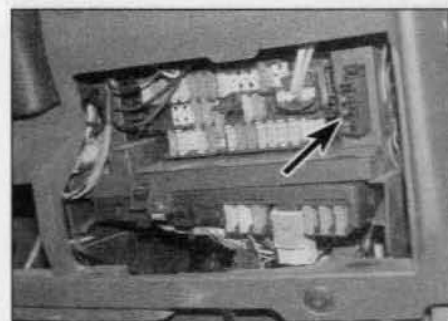

**11.2** The diagnostic socket (arrowed) is located adjacent to the passenger's compartment fusebox.



**12 Throttle housing – removal and refitting**



**Removal**

- 1 Remove the air cleaner assembly as described in Section 2.
- 2 Free the accelerator inner cable from the throttle cam (where applicable).
- 3 Note their fitted positions, then depress the retaining clip and disconnect the wiring connectors from the throttle housing (see illustration).
- 4 Slacken and remove the retaining screws and remove the throttle housing from the inlet manifold (see illustrations). Recover the sealing ring from manifold and discard it; a new one must be used on refitting.

**Refitting**

- 5 Refitting is a reversal of the removal procedure, noting the following points:
  - a) Fit a new sealing ring to the manifold, then refit the throttle housing and securely tighten its retaining screws (see illustration).
  - b) Ensure all wiring is correctly routed, and that the connectors are securely reconnected.
  - c) On completion, adjust the accelerator cable (where applicable) as described in Section 3.



**12.3 Disconnect the wiring connectors from all the throttle housing components – 1.4 litre model shown**

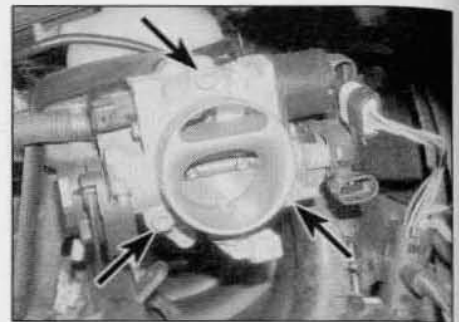

**12.4a Undo the three retaining screws (arrowed) ...**



**12.4b ... then remove the throttle housing from the manifold and recover the sealing ring – 1.4 litre model shown**

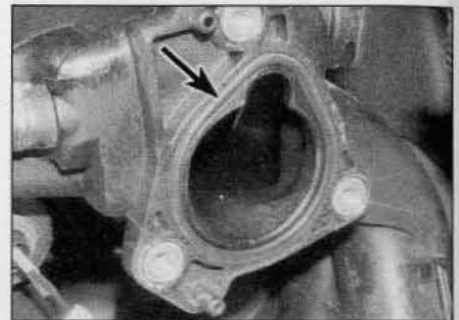

**12.5 On refitting ensure the new sealing ring is correctly fitted to the manifold – 1.4 litre model shown**

**13 Engine management system components – removal and refitting**



**Fuel rail and injectors**

**Note:** Refer to the warning note in Section 1 before proceeding.

**Note:** If a faulty injector is suspected, before condemning the injector, it is worth trying the effect of one of the proprietary injector-cleaning treatments which are available from car accessory shops.

**1.4 litre models**

- 1 Disconnect the battery negative terminal

(refer to *Disconnecting the battery* in the Reference Chapter).

- 2 Remove the air cleaner assembly as described in Section 2.
- 3 On later models with the ignition HT coil module mounted above the fuel rail, remove the coil module as described in Chapter 5B.
- 4 Free the accelerator inner cable (where applicable) from the throttle housing cam, then pull the outer cable out from its mounting bracket rubber grommet, complete with its spring clip.
- 5 Undo the screws and remove the accelerator cable bracket from the manifold/cylinder head (see illustration).
- 6 On early models, disconnect the vacuum pipe from the fuel pressure regulator.
- 7 Bearing in mind the information given in

Section 7, disconnect the fuel feed and, on early models, the return hoses by slackening the retaining clips or disconnecting the quick-release fittings (see illustration).

8 Slacken and remove the two bolts securing the fuel rail to the cylinder head, and the nut securing the rail to the manifold. Loosen the bolt securing the fuel rail centre bracket to the inlet manifold, then lift off the bracket (the bracket is slotted to ease removal) (see illustrations).

9 Disconnect the injector wiring harness connector then unclip the connector from the rear of the inlet manifold. Also disconnect the wiring connectors from the throttle housing and position the wiring harness clear of the manifold so that it does not hinder fuel rail removal.

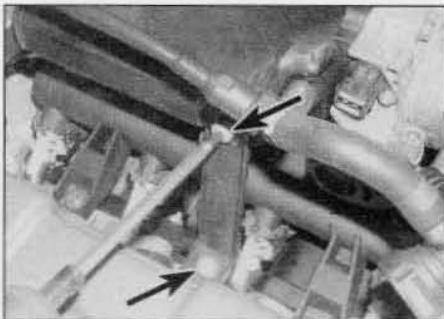

**13.5 Undo the retaining screws (arrowed) and remove the accelerator cable bracket – 1.4 litre models**



**13.7 Depress the retaining clip (arrowed) and disconnect the fuel hose from the fuel rail – 1.4 litre models**

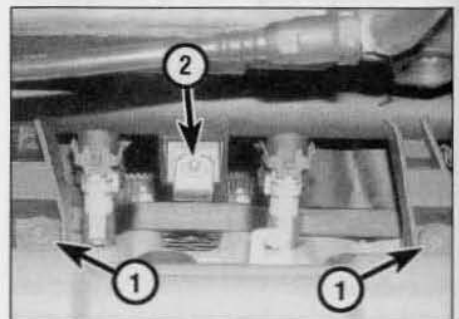

**13.8a Unscrew the fuel rail mounting bolts (1) and the nut (2) ...**

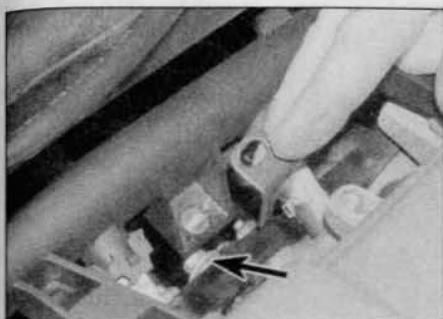

13.8b ... then loosen the bolt (arrowed) and lift off the centre bracket

10 Carefully ease the fuel rail and injector assembly out from the cylinder head and manoeuvre it out of position. Remove the seals from the end of each injector and discard them; they must be renewed whenever they are disturbed (see illustration).

11 Disconnect the wiring connector(s) then slide out the retaining clip(s) and remove the relevant injector(s) from the fuel rail. Remove the upper seal from each disturbed injector and discard; all disturbed seals must be renewed (see illustrations).

12 Refitting is a reversal of the removal procedure, noting the following points.

- a) Fit new seals to all disturbed injector unions (see illustration).
- b) Apply a smear of engine oil to the seals to aid installation, then ease the injectors and fuel rail into position ensuring that none of the seals are displaced.
- c) On completion, reconnect the battery and pressurise the fuel system as described in Section 7. Start the engine and check for fuel leaks.

**1.6 litre models**

13 Remove the inlet manifold as described in Section 14.

14 Undo the two bolts and remove the fuel rail with injectors from the manifold (see illustration).

15 Disconnect the wiring connector(s) then slide out the retaining clip(s) and remove the relevant injector(s) from the fuel rail (see illustration). Remove the seals from each



13.14 Undo the two bolts (arrowed) and remove the fuel rail from the manifold – 1.6 litre models

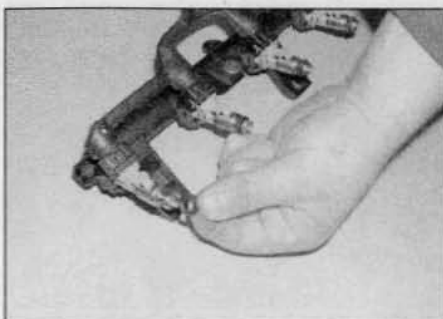

13.10 Remove the seal from the end of each injector – 1.4 litre models

disturbed injector and discard; all disturbed seals must be renewed.

16 Refitting is a reversal of the removal procedure, noting the following points.

- a) Fit new seals to all disturbed injector unions (see illustration).
- b) Apply a smear of engine oil to the seals to aid installation, then ease the injectors and fuel rail into position ensuring that none of the seals are displaced.
- c) On completion, reconnect the battery and pressurise the fuel system as described in Section 7. Start the engine and check for fuel leaks.

**Fuel pressure regulator**

**Note 1:** The following procedure applies to models with the fuel pressure regulator mounted on the fuel rail. On later models, the

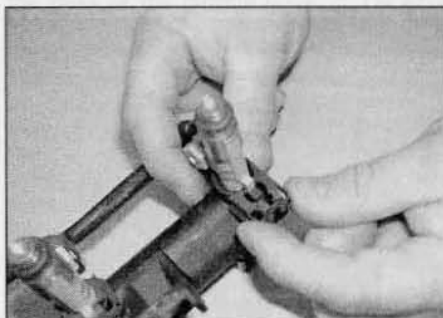

13.11b ... then slide off the retaining clip and remove the injector from the fuel rail – 1.4 litre models

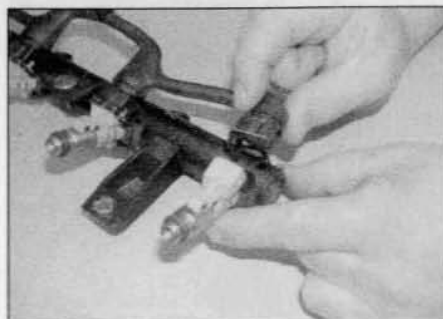

13.11a Disconnect the wiring connector ...

regulator is mounted on the top of the fuel tank, or is integral with the fuel pump. Access to the tank mounted regulator can be gained with the fuel tank removed (see Section 10). Regulators integral with the fuel pump are not available separately.

**Note 2:** Refer to the warning note in Section 1 before proceeding.

17 Disconnect the battery negative terminal (refer to Disconnecting the battery in the Reference Chapter).

18 Disconnect the vacuum pipe from the regulator. Note that on early engines, access to the regulator is poor with the fuel rail in position, if necessary, remove the fuel rail as described earlier, then remove the regulator.

19 Bearing in mind the information given in Section 7, place a wad of rag over the regulator, to catch any fuel spray which may

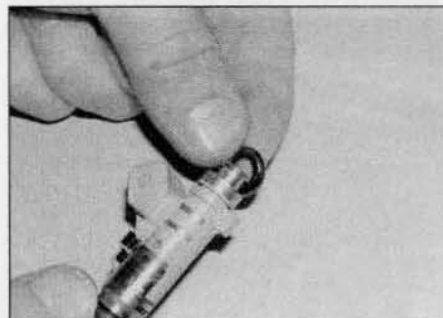

13.12 Renew all injector seals disturbed on removal – 1.4 litre models



13.15 Slide out the retaining clip(s) and remove the relevant injector(s) from the fuel rail – 1.6 litre models

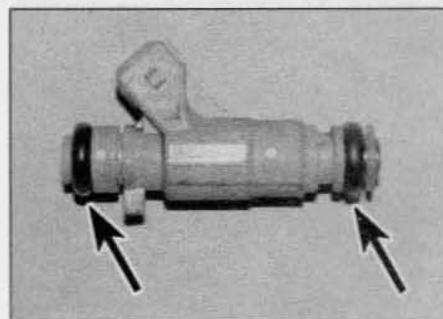

13.16 Renew all injector seals (arrowed) disturbed on removal – 1.6 litre models



13.22 Disconnect the wiring connector from the throttle potentiometer . . .

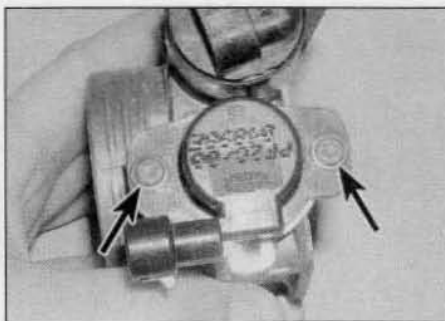

13.23 . . . then undo the retaining screws (arrowed) and remove it from the throttle housing – 1.4 litre models

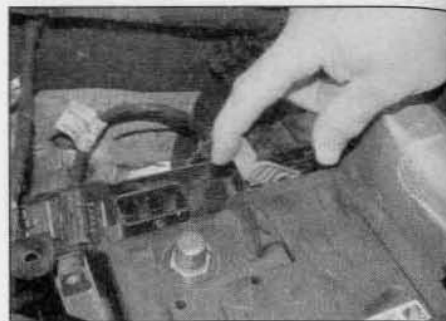

13.27 Lift the locking catches and disconnect the ECU wiring connectors – early models

be released, then remove the retaining clip and ease the regulator out from the fuel rail.

20 Refitting is a reversal of the removal procedure. Examine the regulator seal for signs of damage or deterioration and renew if necessary.

### Throttle potentiometer

**Note:** On 1.4 litre models with the Sagem S2000 system, and all 1.6 litre models, the throttle potentiometer is an integral part of the throttle housing and cannot be removed.

21 Disconnect the battery negative terminal (refer to *Disconnecting the battery* in the Reference Chapter).

22 Depress the retaining clip and disconnect the wiring connector from the throttle potentiometer (see illustration).

23 Slacken and remove the two retaining screws, then disengage the potentiometer from the throttle valve spindle and remove it from the vehicle (see illustration).

24 Refitting is a reversal of the removal procedure, ensuring that the potentiometer is correctly engaged with the throttle valve spindle.

### Electronic Control Unit (ECU)

**Note:** If a new ECU is to be fitted, this work must be entrusted to a Peugeot/Citroën dealer. It is necessary to initialise the new ECU after installation which requires the use of specialist diagnostic equipment.

#### Pre-September 2002 models

25 The ECU is located in the plastic box

which forms part of the rear of the battery tray. On some engines, access to the ECU retaining nuts/bolts is poor and it is beneficial to remove the battery mounting tray as described in Chapter 5A, then remove the ECU with the tray on the bench.

26 Disconnect the battery negative terminal (refer to *Disconnecting the battery* in the Reference Chapter).

27 Where fitted, lift up the cover over the ECU, then lift the locking catches and disconnect the ECU wiring connectors (see illustration).

28 Undo the retaining nuts or bolts and lift the ECU mounting plate from the battery tray.

29 Undo the retaining nuts or bolts and separate the ECU from the mounting plate.

30 Refitting is a reverse of the removal procedure ensuring the wiring connectors are securely reconnected.

#### Post-September 2002 models

31 The ECU is located at the rear left-hand corner of the engine compartment, above the suspension strut upper mounting.

32 Disconnect the battery negative terminal (refer to *Disconnecting the battery* in the Reference Chapter).

33 Undo the retaining nuts and lift off the ECU cover, where fitted (see illustrations).

34 Lift the ECU up and off the mounting bracket, then lift the locking catches and disconnect the wiring connectors (see illustration).

35 If required, the mounting bracket can be removed after undoing the three retaining nuts (see illustration).

36 Refitting is a reverse of the removal procedure ensuring the wiring connectors are securely reconnected.

### Idle speed stepper motor

**Note:** On 1.4 litre models with the Sagem S2000 system, and all 1.6 litre models, the stepper motor is an integral part of the throttle housing and cannot be removed.

37 The idle speed stepper motor is fitted to the rear of the throttle housing.

38 Disconnect the battery negative terminal (refer to *Disconnecting the battery* in the Reference Chapter), then disconnect the

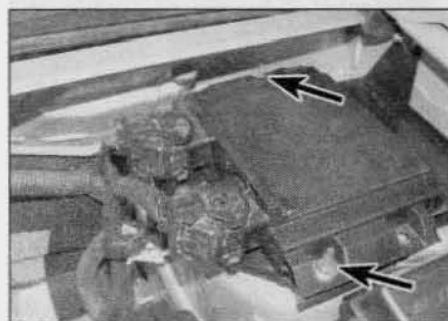

13.33a Undo the retaining nuts (arrowed) . . .



13.33b . . . and lift off the ECU cover – later models



13.34 Lift the ECU off the mounting bracket, then disconnect the wiring connectors – later models

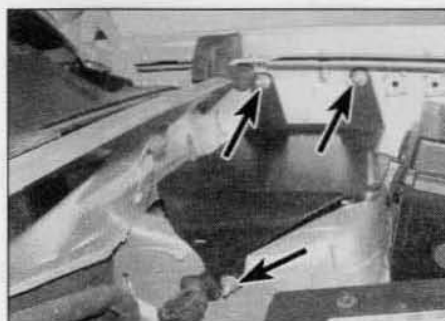

13.35 ECU mounting bracket retaining bolts (arrowed) – later models





**13.38** Disconnect the wiring connector from the idle speed stepper motor (arrowed) . . .

wiring connector from the motor (see illustration).

**39** Slacken and remove the retaining screws then remove the motor from the throttle housing (see illustration). If necessary, remove the throttle potentiometer to improve access to the motor lower screw.

**40** Refitting is a reversal of the removal procedure ensuring the seal is in good condition.

### Manifold pressure sensor

**41** The manifold pressure sensor is mounted on the front of the inlet manifold.

**42** Disconnect the battery negative terminal (refer to *Disconnecting the battery* in the Reference Chapter).

**43** Disconnect the wiring connector then undo the screw and remove the sensor from the manifold (see illustration).

**44** Refitting is a reversal of the removal procedure ensuring the sensor seal is in good condition.

### Coolant temperature sensor

**45** The coolant temperature sensor is screwed into the coolant outlet housing on the left-hand end of the cylinder head. Refer to Chapter 3 for removal and refitting details.

### Inlet air temperature sensor

**Note:** On 1.4 litre models with the Sagem S2000 system, and all 1.6 litre models, the

**TOOL TIP**



The inlet air temperature sensor clips can be released by passing a close-fitting ring spanner over the end of the sensor.

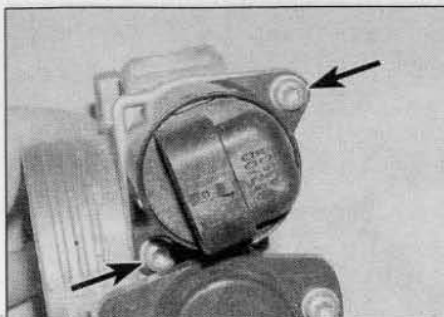

**13.39** . . . then undo the retaining screws (arrowed) and remove the motor from the throttle housing – 1.4 litre models



**13.47** Disconnect the wiring connector . . .

*inlet air temperature sensor is an integral part of the throttle housing and cannot be removed.*

**46** The inlet air temperature sensor is fitted to the base of the throttle housing. On early models, the sensor is threaded into the underside of the throttle housing, whereas on later models it is clipped in position.

**47** Disconnect the battery negative terminal (refer to *Disconnecting the battery* in the Reference Chapter), then disconnect the wiring connector from the sensor (see illustration).

**48** Unscrew the sensor, or release the retaining clips (see **Tool Tip**) and ease the sensor out from the throttle housing (see illustration).

**49** Refitting is a reversal of the removal procedure ensuring the sensor seal is in good condition.

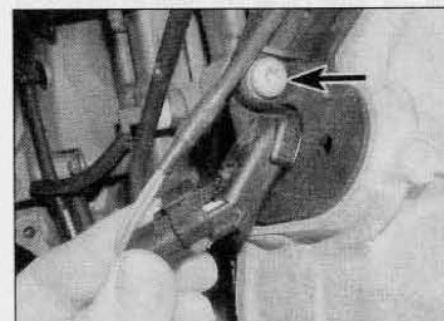

**13.52a** Disconnect the wiring connector and undo the retaining screw (arrowed) . . .

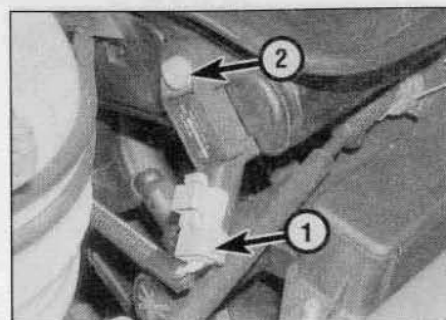

**13.43** Disconnect the manifold pressure sensor wiring connector (1), then undo the retaining screw (2) – 1.4 litre model shown

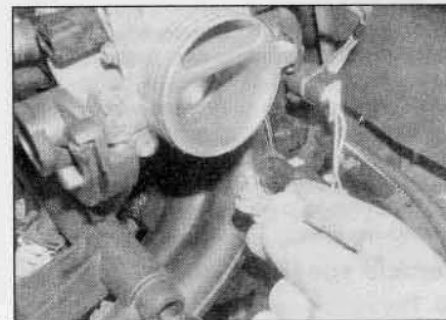

**13.48** . . . then unclip the inlet air temperature sensor from the throttle housing – 1.4 litre models

### Crankshaft sensor

**50** The crankshaft sensor is situated on the front face of the transmission clutch housing.

**51** Disconnect the battery negative terminal (refer to *Disconnecting the battery* in the Reference Chapter).

**52** Disconnect the sensor wiring connector and unclip the wiring. Undo the retaining bolt and remove the sensor and bracket assembly from the transmission unit (see illustrations).

**53** Refitting is a reversal of the removal procedure.

### Throttle housing heating element

**Note:** The heating element is only fitted to aluminium throttle housings. Plastic housings do not need a heater.



**13.52b** . . . then remove the crankshaft sensor from the front of the transmission clutch housing

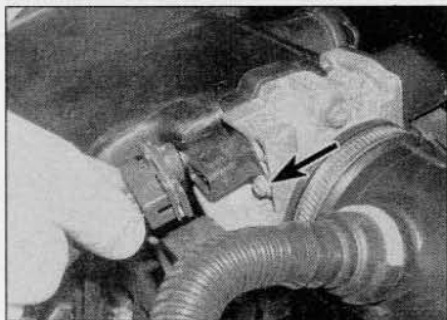

**13.56a** Disconnect the wiring connector then undo the retaining screw (arrowed) . . .

**54** The heating element is fitted to the top of the throttle housing.

**55** Disconnect the battery negative terminal (refer to *Disconnecting the battery* in the Reference Chapter).

**56** Disconnect the wiring connector then unscrew the retaining screw and remove the heating element from the throttle housing (see illustrations).

**57** Refitting is a reversal of the removal procedure.

### Vehicle speed sensor

**58** The vehicle speed sensor is an integral part of the speedometer drive. Refer to Chapter 7 for removal and refitting details.

### Knock sensor

**59** The knock sensor is screwed onto the rear of the cylinder block. Refer to Chapter 5B for removal and refitting details.

### Fuel cut-off inertia switch

**60** The fuel cut-off inertia switch is located in the right-hand rear corner of the engine compartment.

**61** Disconnect the battery negative terminal (refer to *Disconnecting the battery* in the Reference Chapter).

**62** Cut the retaining clip (where fitted) then unscrew the retaining nuts and remove the switch from the vehicle, disconnecting it from the wiring connector.

**63** Refitting is a reversal of the removal procedure. On completion, reset the switch by firmly depressing its button.

### Camshaft position sensor

**Note:** The camshaft position sensor is only fitted to 1.4 litre models with Motronic MP7.3 systems.

**64** The camshaft position sensor is fitted to the rear of the coolant outlet housing on the left-hand end of the cylinder head.

**65** Disconnect the battery negative terminal (refer to *Disconnecting the battery* in the Reference Chapter).

**66** Disconnect the wiring connector then unscrew the retaining bolt and remove the sensor from the housing.

**67** Refitting is a reversal of the removal procedure, ensuring the sensor seal is in good condition.

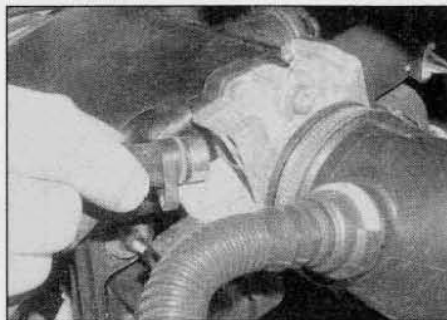

**13.56b** . . . and remove the heating element from the throttle housing – 1.4 litre models

### Body accelerometer

**Note:** The camshaft position sensor is only fitted to 1.4 litre models with Motronic MP7.3 systems.

**68** The body accelerometer is located in the engine compartment. To remove it, first disconnect the battery negative terminal (refer to *Disconnecting the battery* in the Reference Chapter).

**69** Disconnect the wiring connector then unscrew the mounting bolt and remove the sensor from the vehicle.

**70** Refitting is a reversal of the removal procedure.

### Throttle valve positioner motor

**71** The throttle valve positioner motor is fitted to 1.4 litre models with the Sagem S2000 system, and all 1.6 litre models. The unit is integral with the throttle housing, and is not available separately.

### Accelerator pedal position sensor

**Note:** The accelerator pedal position sensor is fitted to 1.4 litre models with the Sagem S2000 system, and all 1.6 litre models.

**72** The accelerator pedal position sensor is located above the right-hand engine/transmission mounting (see illustration).

**73** Disconnect the battery negative terminal (refer to *Disconnecting the battery* in the Reference Chapter), then disconnect the wiring connector from the pedal position sensor.

**74** Free the accelerator inner cable from the accelerator pedal position sensor cam, then pull the outer cable out from its mounting



**14.5a** Disconnect the braking system servo vacuum pipe . . .

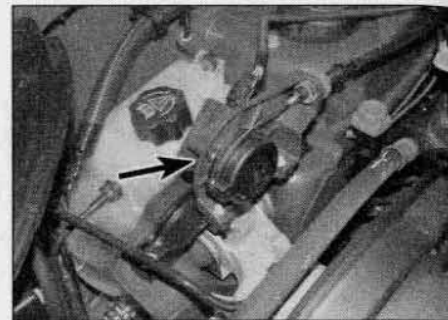

**13.72** Accelerator pedal position sensor location (arrowed)

bracket rubber grommet. Recover the spring clip from the outer cable.

**75** Undo the two mounting bracket retaining bolts and withdraw the pedal position sensor and mounting bracket from the engine compartment.

**76** Undo the two nuts and bolts securing the sensor to the mounting bracket and separate the two components.

**77** Refitting is a reversal of the removal procedure. On completion, adjust the accelerator cable as described in Section 3.

### 14 Inlet manifold – removal and refitting



### Removal

#### 1.4 litre models

**1** Remove the air cleaner assembly as described in Section 2.

**2** Remove the fuel rail and injectors as described in Section 13.

**3** If not already done, disconnect the wiring connectors from the throttle housing components then unclip the harness and position it clear of the manifold

#### 1.6 litre models

**4** Remove the throttle housing as described in Section 12.

#### All models

**5** Release the retaining clips and disconnect the vacuum servo unit pipe and purge valve pipe from the inlet manifold (see illustrations).

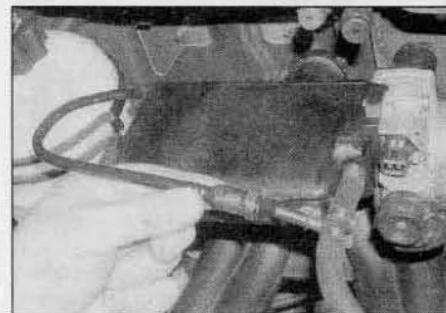

**14.5b** . . . and the purge valve pipe from the inlet manifold – 1.4 litre models shown



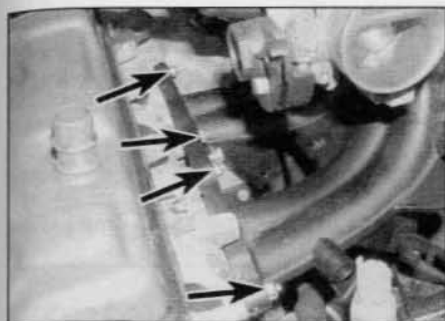

14.9 Inlet manifold upper nuts arrowed – 1.4 litre models shown

6 Disconnect all wiring connectors from the manifold, having first noted their fitted positions. Release the wiring from any retaining clips.

7 Depress the release button and disconnect the fuel pipe and position it clear of the manifold.

8 Where necessary, undo the retaining bolts and remove the support bracket from the underside of the manifold.

9 Undo the manifold retaining nuts and withdraw the manifold from the engine compartment (see illustration). Recover the four manifold seals and discard them; new ones must be used on refitting.

### Refitting

10 Refitting is a reverse of the relevant removal procedure, noting the following points:

- Ensure that the manifold and cylinder head mating surfaces are clean and dry, then locate the new seals in their recesses in the manifold (see illustration). Refit the manifold and tighten its retaining nuts to the specified torque.
- Ensure that all relevant hoses are reconnected to their original positions and are securely held (where necessary) by the retaining clips.
- Ensure the wiring is correctly routed and all connectors are securely reconnected.
- Adjust the accelerator cable (where applicable) as described in Section 3.

### 15 Exhaust manifold – removal and refitting

#### Removal

1 On 1.4 litre models with secondary air injection, remove the secondary air injection valve as described in Part D of this Chapter.

2 Firmly apply the handbrake, then jack up the front of the vehicle and support it on axle stands (see *Jacking and vehicle support*).

3 Trace the lambda (oxygen) sensor(s) wiring back to the connectors and disconnect them.

4 Slacken and remove the retaining bolts and remove the shroud from the top of the exhaust manifold (see illustration). It may be necessary

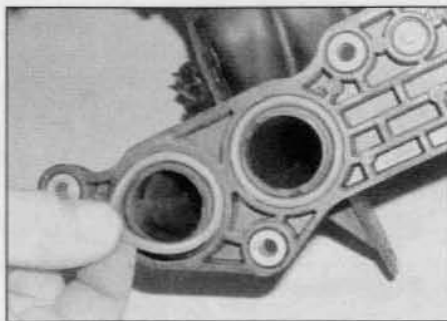

14.10 Ensure the new sealing rings are correctly fitted to the manifold prior to refitting

to remove the engine lifting eye bracket from the left-hand end of the cylinder head, and undo the bolt and remove the oil dipstick tube. Feed the lambda sensor wiring through the hole in the top of the shroud as it is removed.

5 On some models, a second heat shield is fitted on the underside of the manifold, above the oil filter. Undo the bolts and remove the heat shield.

6 Undo the nuts securing the exhaust front pipe/catalytic converter to the manifold, then remove the bolt securing the front pipe to its mounting bracket. Disconnect the front pipe from the manifold, and recover the gasket.

7 Undo the retaining nuts securing the manifold to the cylinder head. Manoeuvre the manifold out of the engine compartment, and discard the manifold gasket(s).

### Refitting

8 Refitting is the reverse of the removal procedure, noting the following points:

- Examine all the exhaust manifold studs for signs of damage and corrosion; remove all traces of corrosion, and repair or renew any damaged studs.
- Ensure that the manifold and cylinder head sealing faces are clean and flat, and fit the new manifold gasket(s). Tighten the manifold retaining nuts to the specified torque.
- Reconnect the front pipe to the manifold using the information given in Section 16.
- Where necessary, renew the oil dipstick tube O-ring.

### 16 Exhaust system – general information, removal and refitting

#### General information

1 On early models, the exhaust system consists of four sections; the front pipe, the catalytic converter, the intermediate pipe and centre silencer, and the tailpipe with rear silencer. All exhaust sections are joined by a flanged joint. The front pipe joints are secured by nuts and bolts, the catalytic converter joint being of the spring-loaded ball type, to allow for movement in the exhaust system. The

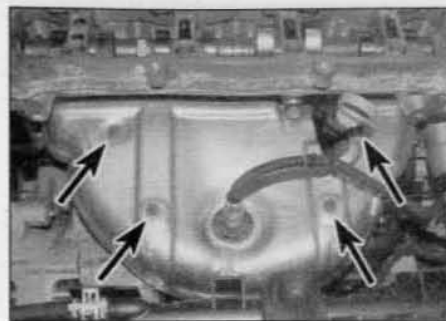

15.4 Slacken and remove the retaining bolts (arrowed) and remove the shroud from the top of the exhaust manifold

catalytic converter-to-intermediate pipe joint and the intermediate pipe-to-silencer joint are secured by a clamping ring.

2 On later models, the exhaust system consists three sections; the front pipe with integral catalytic converter, the intermediate pipe and centre silencer, and the tailpipe with rear silencer. The front pipe and intermediate pipe sections are joined by flanged joints. All other joints are secured by clamping rings.

3 The system is suspended throughout its entire length by rubber mountings.

### Removal

4 Each exhaust section can be removed individually or, alternatively, the complete system can be removed as a unit. Even if only one part of the system needs attention, it is often easier to remove the whole system and separate the sections on the bench.

5 To remove the system or part of the system, first jack up the front or rear of the car and support it on axle stands (see *Jacking and vehicle support*). Alternatively, position the car over an inspection pit or on car ramps.

### Front pipe

**Note:** On later models, the catalytic converter is integral with the front pipe.

6 Trace the wiring back from the lambda sensor to its wiring connectors, which are clipped to the transmission housing, and disconnect them from the main harness.

7 Undo the nuts securing the front pipe flange joint to the manifold, and the single bolt securing the front pipe to its mounting bracket (see illustration). Separate the flange joint and collect the gasket.

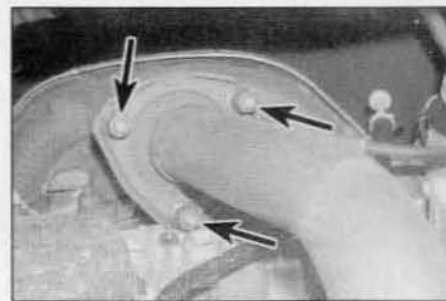

16.7 Front pipe-to-manifold nuts (arrowed) – early models



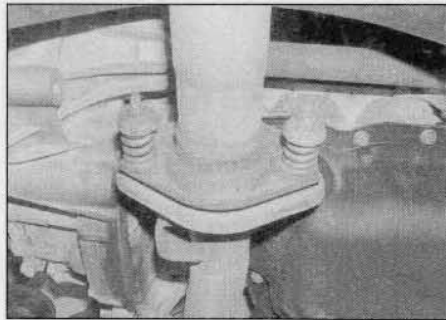

**16.12 Front pipe-to-intermediate pipe spring-loaded joint – later models**

**8** Slacken and remove the two nuts securing the front pipe flange joint to the catalytic converter or intermediate pipe, and recover the spring cups and springs. Remove the bolts, then withdraw the front pipe from underneath the vehicle, and recover the wire-mesh gasket.

#### Catalytic converter (early models)

**Note:** On later models, the catalytic converter is integral with the front pipe.

**9** Undo the two nuts securing the front pipe flange joint to the catalytic converter. Recover the springs and spring cups, and withdraw the bolts.

**10** Slacken the catalytic converter clamping ring bolts and disengage the clamp from the flange joint.

**11** Free the converter, then withdraw it from underneath the vehicle, and recover the wire-mesh gasket from the front pipe joint.

#### Intermediate pipe

**12** On later models, slacken and remove the two nuts securing the front pipe flange joint to the intermediate pipe, and recover the spring cups and springs (**see illustration**). Remove

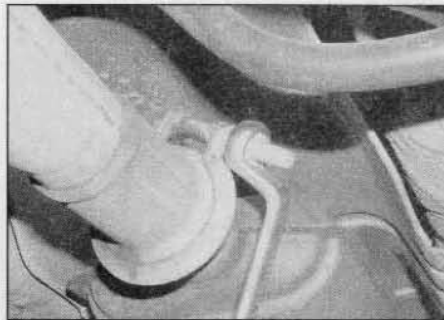

**16.13 Slacken and remove the nut, washer and bolt, then free the clamping ring from the flange joint**

the bolts, then withdraw the front pipe from underneath the vehicle, and recover the wire-mesh gasket.

**13** Slacken the clamping ring bolts and disengage the clamp(s) from the flange joint(s) (**see illustration**).

**14** Unhook the intermediate pipe from its mounting rubber and remove it from underneath the vehicle.

#### Tailpipe

**15** Slacken the tailpipe clamping ring bolts and disengage the clamp from the flange joint.

**16** Unhook the tailpipe from its mounting rubbers and remove it from the vehicle.

#### Complete system

**17** Disconnect the lambda sensor wiring connectors from the main wiring harness.

**18** Undo the nuts securing the front pipe flange joint to the manifold, and the single bolt securing the front pipe to its mounting bracket. Separate the flange joint and collect the gasket. Free the system from all its mounting rubbers and lower it from under the vehicle.

#### Heat shield(s)

**19** The heat shields are secured to the underside of the body by various nuts and bolts. Each shield can be removed once the relevant exhaust section has been removed. If a shield is being removed to gain access to a component located behind it, it may prove sufficient in some cases to remove the retaining nuts and/or bolts, and simply lower the shield, without disturbing the exhaust system.

#### Refitting

**20** Each section is refitted by reversing the removal sequence, noting the following points:

- a) Ensure that all traces of corrosion have been removed from the flanges and renew all necessary gaskets.
- b) Inspect the rubber mountings for signs of damage or deterioration, and renew as necessary.
- c) Prior to assembling the spring-loaded joint, a smear of high-temperature grease should be applied to the joint mating surfaces.
- d) Where joints are secured together by a clamping ring, apply a smear of exhaust system jointing paste to the flange joint, to ensure a gas-tight seal. Tighten the clamping ring nuts evenly and progressively, so that the clearance between the clamp halves remains equal on either side.
- e) Prior to tightening the exhaust system fasteners, ensure that all rubber mountings are correctly located, and that there is adequate clearance between the exhaust system and vehicle underbody.
- f) Ensure that the lambda sensor wiring is reconnected correctly and secured to the underbody by the relevant retaining clips.

# Chapter 4 Part B:

## Fuel and exhaust systems – 1.8 and 1.9 litre (XUD series) diesel models

### Contents

Section number	Section number
Accelerator cable – removal, refitting and adjustment . . . . . 11	Fuel injectors – testing, removal and refitting . . . . . 10
Accelerator pedal – removal and refitting . . . . . 12	Fuel system – priming and bleeding . . . . . 2
Air cleaner and associated components – removal and refitting . . . 3	Fuel tank – removal and refitting . . . . . 14
Air filter renewal . . . . . See Chapter 1B	General information and precautions . . . . . 1
Exhaust system – general information and component renewal . . . 16	Injection timing – checking methods and adjustment . . . . . 6
Fast idle thermostatic sensor – removal, refitting and adjustment . . 4	Injection timing (Bosch fuel injection pump) – checking and adjustment . . . . . 8
Fuel filter renewal . . . . . See Chapter 1B	Injection timing (Lucas fuel injection pump) – checking and adjustment . . . . . 7
Fuel filter water draining . . . . . See Chapter 1B	Manifolds – removal and refitting . . . . . 15
Fuel gauge sender and pick-up unit – removal and refitting . . . . . 13	
Fuel injection pump – adjustment . . . . . 9	
Fuel injection pump – removal and refitting . . . . . 5	

### Degrees of difficulty

**Easy**, suitable for novice with little experience



**Fairly easy**, suitable for beginner with some experience



**Fairly difficult**, suitable for competent DIY mechanic



**Difficult**, suitable for experienced DIY mechanic



**Very difficult**, suitable for expert DIY or professional



### Specifications

#### General

System type . . . . .	Rear-mounted fuel tank, distributor fuel injection pump with integral transfer pump, indirect injection.
Firing order . . . . .	1-3-4-2 (No 1 at flywheel end)

#### Injection pump

Type . . . . .	Bosch or Lucas
Direction of rotation . . . . .	Clockwise, viewed from sprocket end

#### Pump timing\*:

Lucas pump – engine code A9A (XUD7L), D9B (XUD9A) and DJY (XUD9Y):

##### Static timing:

Engine position . . . . .	No 4 piston at TDC
Pump position . . . . .	Value shown on pump – see text

Bosch pump – engine code DJY (XUD9Y):

##### Static timing:

Engine position . . . . .	No 4 piston at TDC
Pump timing measurement . . . . .	0.66 ± 0.02 mm

#### Idle speed:

Without air conditioning . . . . .	800 +0 –50 rpm
With air conditioning . . . . .	850 +0 –50 rpm
Anti-stall speed . . . . .	1500 ± 100 rpm

#### Anti-stall shim thickness\*:

With Lucas pump . . . . .	4.0 mm
With Bosch pump . . . . .	3.0 mm

#### Fast idle speed . . . . .

	950 ± 50 rpm
--	--------------

#### Maximum speed\*:

Engine codes A9A (XUD7L) and D9B (XUD9A) . . . . .	5150 ± 125 rpm
Engine code DJY (XUD9Y):	
With Lucas pump . . . . .	5150 ± 125 rpm
With Bosch pump . . . . .	5100 ± 80 rpm

\* Refer to Chapter 2B for further information on engine code identification

**Injectors**

Type .....	Pintle
Opening pressure:	
With Lucas pump .....	140 bars
With Bosch pump .....	130 bars

**Torque wrench settings**

	Nm	lbf ft
Fuel pipe union nuts .....	20	15
Injection pump mounting nuts/bolts .....	20	15
Injection pump sprocket nut .....	50	37
Injection pump sprocket puller bolts .....	10	7
Injection pump timing hole blanking plug:		
Lucas pump .....	6	4
Bosch pump .....	15	11
Injectors to cylinder head .....	90	66
No 4 cylinder TDC blanking plug .....	30	22

**1 General information and precautions****General information**

**1** The fuel system consists of a rear-mounted fuel tank, a fuel filter with integral water separator, a fuel injection pump, injectors and associated components. Before passing through the filter, the fuel is heated by coolant flowing through the base of the fuel filter/thermostat housing.

**2** Fuel is drawn from the fuel tank to the fuel injection pump by a vane-type transfer pump incorporated in the fuel injection pump. Before reaching the pump, the fuel passes through a fuel filter, where foreign matter and water are removed. Excess fuel lubricates the moving components of the pump, and is then returned to the tank.

**3** The fuel injection pump is driven at half-crankshaft speed by the timing belt. The high pressure required to inject the fuel into the compressed air in the swirl chambers is achieved by a cam plate acting on a single piston on the Bosch pump, or by two opposed pistons forced together by rollers running in a cam ring on the Lucas (CAV) pump. The fuel passes through a central rotor with a single outlet drilling which aligns with ports leading to the injector pipes.

**4** Fuel metering is controlled by a centrifugal governor, which reacts to accelerator pedal position and engine speed. The governor is linked to a metering valve, which increases or decreases the amount of fuel delivered at each pumping stroke.

**5** Basic injection timing is determined when the pump is fitted. When the engine is running, it is varied automatically to suit the prevailing engine speed by a mechanism which turns the cam plate or ring.

**6** The four fuel injectors produce a homogeneous spray of fuel into the swirl chambers located in the cylinder head. The

injectors are calibrated to open and close at critical pressures to provide efficient and even combustion. Each injector needle is lubricated by fuel, which accumulates in the spring chamber and is channelled to the injection pump return hose by leak-off pipes.

**7** Bosch or Lucas fuel system components may be fitted, depending on the model. Components from the latter manufacturer are marked either 'CAV', 'Roto-Diesel' or 'Con-Diesel', depending on their date and place of manufacture. With the exception of the fuel filter assembly, new components must be of the same make as those originally fitted.

**8** Cold starting is assisted by preheater or 'glow plugs' fitted to each swirl chamber. A thermostatic sensor in the cooling system operates a fast idle lever on the injection pump to increase the idling speed when the engine is cold.

**9** A stop solenoid cuts the fuel supply to the injection pump rotor when the ignition is switched off, and there is also a hand-operated stop lever for use in an emergency (see illustrations).

**10** Provided that the specified maintenance is carried out, the fuel injection equipment will give long and trouble-free service. The injection pump itself may well outlast the engine. The main potential cause of damage to the injection pump and injectors is dirt or water in the fuel.

**11** Servicing of the injection pump and injectors is very limited for the home mechanic, and any dismantling or adjustment other than that described in this Chapter must be entrusted to a Peugeot/Citroën dealer or fuel injection specialist.

**Precautions**

**Warning:** It is necessary to take certain precautions when working on the fuel system components, particularly the fuel injectors. Before carrying out any operations on the fuel system, refer to the precautions given in 'Safety first!' at the beginning of this manual, and to any additional warning notes at the start of the relevant Sections.

**2 Fuel system – priming and bleeding**

**1** After disconnecting part of the fuel supply system or running out of fuel, it is necessary to prime the system and bleed off any air which may have entered the system components.

**2** All models are fitted with a hand-operated priming pump, consisting of a rubber bulb,

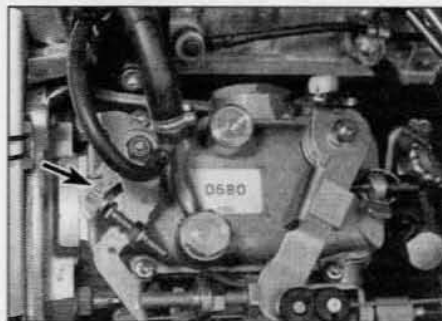

**1.9a** Hand-operated stop lever (arrowed) – Lucas pump

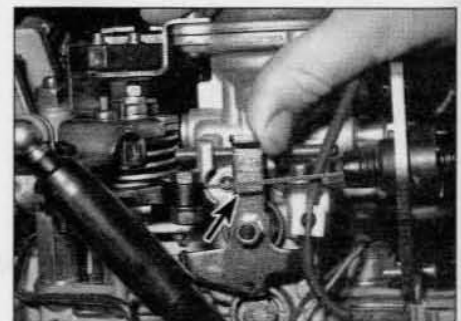

**1.9b** Hand-operated stop lever (arrowed) – Bosch pump





2.2 Hand-operated fuel system priming pump

which is located on the right-hand side of the engine compartment (see illustration).

3 An automatic bleed valve is fitted to certain engines, which bleeds the air from the low pressure circuit when it is primed. On engines without an automatic bleed valve, a bleed screw is fitted to the injection pump fuel inlet pipe union bolt. Where a bleed screw is fitted, slacken the screw half a turn.

4 Pump the priming pump bulb until fuel free from air bubbles emerges from the bleed screw (where fitted), or until resistance is felt. Retighten the bleed screw.

5 Switch on the ignition (to activate the stop solenoid) and continue pumping the priming pump until firm resistance is felt, then pump a few more times.

6 If a large amount of air has entered the pump, place a wad of rag around the fuel return union on the pump (to absorb spilt fuel), then slacken the union. Operate the priming plunger (with the ignition switched on to activate the stop solenoid), or crank the engine on the starter motor in 10 second bursts, until fuel free from air bubbles emerges from the fuel union. Tighten the union and mop-up spilt fuel.



**Warning: Be prepared to stop the engine if it should fire, to avoid excessive fuel spray and spillage.**

7 If air has entered the injector pipes, place wads of rag around the injector pipe unions at the injectors (to absorb spilt fuel), then slacken the unions. Crank the engine on the starter motor until fuel emerges from the unions, then stop cranking the engine and retighten the unions. Mop-up spilt fuel. Refer to the warning given in the previous paragraph.

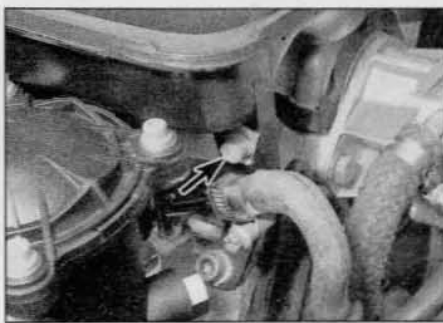

3.5 Front air distribution housing securing bolt (arrowed)

8 Start the engine with the accelerator pedal fully depressed. Additional cranking may be necessary to finally bleed the system before the engine starts.

### 3 Air cleaner and associated components – removal and refitting

#### Removal

##### Air cleaner

1 Slacken the retaining clips securing the air cleaner-to-manifold duct in position and undo the duct mounting bolt. Disconnect the duct and remove it from the engine.

2 Slacken and remove the two bolts securing the air intake duct to the front body panel. Slacken the retaining clip then detach the duct from the side of the air cleaner and remove it from the vehicle.

3 Undo the bolt securing the base of the air cleaner housing to the support bracket. Lift up the housing, disengage the front locating pegs and remove it from the vehicle.

##### Air distribution housing – 1.9 litre models

4 Disconnect the air duct and the crankcase breather hose from the front of the air distribution housing.

5 Unscrew the two bolts securing the housing to the front mounting brackets (see illustration). Recover the spacer plates.

6 Unscrew the four bolts securing the

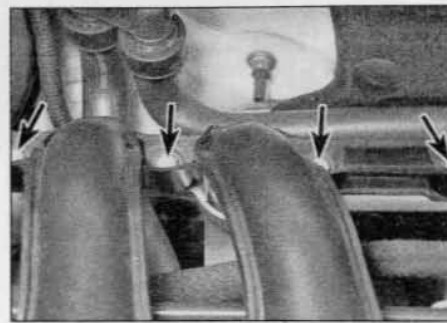

3.6 Air distribution housing-to-inlet manifold bolts (arrowed)

housing to the inlet manifold. Recover the washers (see illustration).

7 Lift the housing from the inlet manifold, and recover the seals.

#### Refitting

8 Refitting is the reverse of the relevant removal procedure. Examine the condition of the seals and renew if necessary.

### 4 Fast idle thermostatic sensor – removal, refitting and adjustment

**Note: A new sealing washer must be used when refitting the sensor.**

#### Removal

1 The thermostatic sensor is located in the side of the thermostat/fuel filter housing.

2 For improved access on 1.9 litre models, remove the air distribution housing as described in Section 3. If necessary, also remove the intake duct, and disconnect the breather hose from the engine oil filler tube. Refer to the relevant Sections of this Chapter for further information.

3 Drain the cooling system as described in Chapter 1B.

4 Loosen the clamp screw or nut (as applicable), and disconnect the fast idle cable end fitting from the inner cable at the fuel injection pump fast idle lever (see illustrations).

5 Slide the cable from the adjustment screw located in the bracket on the fuel injection pump (see illustration).

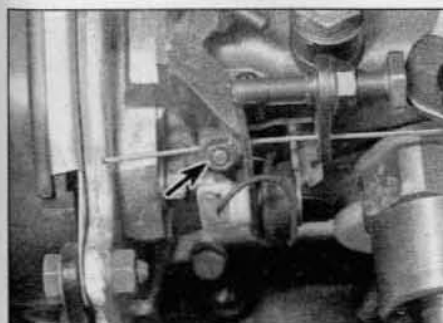

4.4a Fast idle cable end fitting clamp nut (arrowed) – Lucas pump

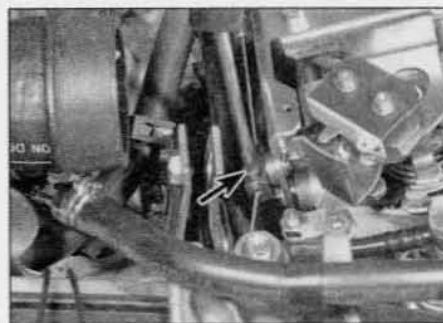

4.4b Loosening the fast idle cable end fitting clamp screw (arrowed) – Bosch pump



4.5 Sliding the fast idle cable from the adjustment screw – Bosch pump

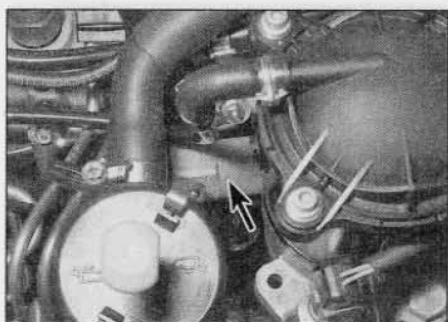

4.6 Fast idle thermostatic sensor (arrowed)

6 Using a suitable open-ended spanner, unscrew the thermostatic sensor from the fuel filter/thermostat housing, and withdraw the sensor complete with the cable (see illustration). Recover the sealing washer, where applicable.

### Refitting

7 If sealing compound was originally used to fit the sensor in place of a washer, thoroughly clean all traces of old sealing compound from the sensor and housing. Ensure that no traces of sealant are left in the internal coolant passages of the housing.

8 Fit the sensor, using suitable sealing compound or a new washer as applicable, and tighten it securely.

9 Insert the adjustment screw into the bracket on the fuel injection pump, and screw on the locknut finger-tight.

10 Insert the inner cable through the fast idle lever, and position the end fitting on the cable, but do not tighten the clamp screw or nut (as applicable).

11 Adjust the cable as described in the following paragraphs.

### Adjustment

12 With the engine cold, push the fast idle lever fully towards the flywheel end of the engine. Tighten the clamp screw or nut with the cable end fitting touching the lever.

13 Adjust the screw to ensure that the fast idle lever is touching its stop, then tighten the locknut.

14 Measure the exposed length of the inner cable.

15 Refit the components removed for access to the sensor, with reference to the relevant Sections of this Chapter.

16 Refill the cooling system as described in Chapter 1B, and run the engine to its normal operating temperature.

17 Check that the fast idle cable is slack. If not, it is likely that the sensor is faulty.

18 With the engine hot, check that there is approximately 0.5 to 1 mm of free play in the cable on Lucas injection pumps and 5 to 6 mm of free play in the cable on Bosch injection pumps. This indicates that the thermostatic sensor is functioning correctly.

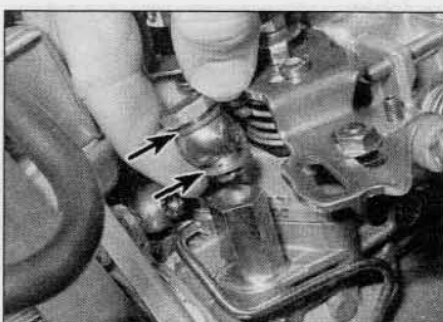

5.9a Disconnecting the fuel pump fuel supply banjo union. Note sealing washers (arrowed) – Bosch pump

19 Check that the engine speed increases when the fast idle lever is pushed towards the flywheel end of the engine. With the lever against its stop, the fast idle speed should be as specified (see Section 9 for fast idle adjustment details).

20 Stop the engine.

## 5 Fuel injection pump – removal and refitting

**Caution:** Be careful not to allow dirt into the injection pump or injector pipes during this procedure. New sealing rings should be used on the fuel pipe banjo unions when refitting.

### Removal

1 Disconnect the battery negative terminal (refer to *Disconnecting the battery* in the Reference Chapter).

2 Cover the alternator with a plastic bag, as a precaution against spillage of diesel fuel.

3 For improved access on 1.9 litre models remove the air distribution housing as described in Section 3. If necessary, also remove the intake duct, and disconnect the breather hose from the engine oil filler tube. Refer to the relevant Sections of this Chapter for further information.

4 Chock the rear wheels and release the handbrake. Jack up the front right-hand corner of the vehicle until the wheel is just clear of the ground. Support the vehicle on an

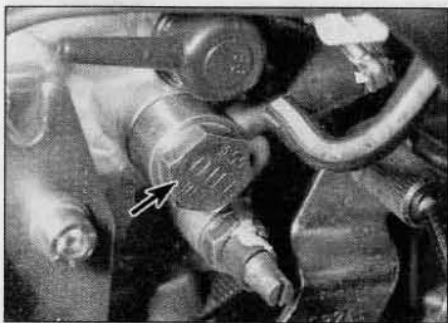

5.10 Injection pump fuel return pipe banjo union (arrowed) – Bosch pump



5.9b Refitting the fuel supply banjo bolt with a small section of fuel hose (arrowed) to prevent dirt entry – Bosch pump

axle stand (see *Jacking and vehicle support*) and engage 4th or 5th gear. This will enable the engine to be turned easily by turning the right-hand wheel.

5 Remove the upper timing belt covers with reference to Chapter 2B.

6 Where necessary, disconnect the hoses from the vacuum converter on the end of the fuel injection pump.

7 Disconnect the accelerator cable from the fuel injection pump, with reference to Section 11.

8 Disconnect the fast idle cable from the fuel injection pump, with reference to Section 4.

9 Loosen the clip, or undo the banjo union, and disconnect the fuel supply hose. Recover the sealing washers from the banjo union, where applicable. Cover the open end of the hose, and refit and cover the banjo bolt to keep dirt out (see illustrations).

10 Disconnect the main fuel return pipe and the injector leak-off return pipe banjo union (see illustration). Recover the sealing washers from the banjo union. Again, cover the open end of the hose and the banjo bolt to keep dirt out. Take care not to get the inlet and outlet banjo unions mixed up.

11 Disconnect all relevant wiring from the pump. Note that on certain Bosch pumps, this can be achieved by simply disconnecting the wiring connectors at the brackets on the pump (see illustration). On some pumps, it will be necessary to disconnect the wiring from the individual components (some connections may be protected by rubber covers).

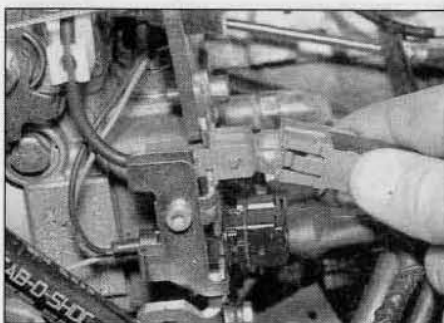

5.11 Disconnecting a fuel injection pump wiring plug – Bosch pump



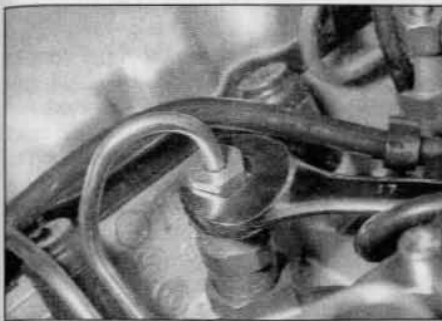

5.12a Unscrewing a fuel pipe-to-injector union



5.12b Cover the open end of the injector to prevent dirt entry

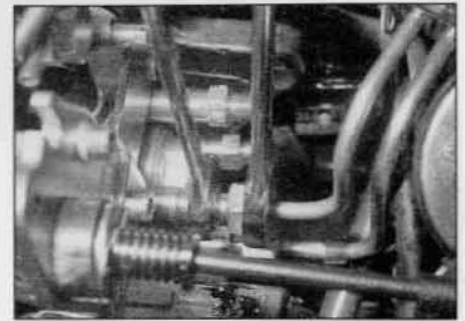

5.12c Unscrewing a fuel pipe-to-pump union – Bosch pump

12 Unscrew the union nuts securing the injector pipes to the fuel injection pump and injectors. Counterhold the unions on the pump, while unscrewing the pipe-to-pump union nuts. Remove the pipes as a set. Cover open unions to keep dirt out, using small plastic bags, or fingers cut from discarded (but clean!) rubber gloves (see illustrations).

13 Turn the crankshaft until the two bolt holes in the fuel injection pump sprocket are aligned with the corresponding holes in the engine front plate.

14 Insert two M8 bolts through the holes, and hand-tighten them. Note that the bolts must retain the sprocket while the fuel injection pump is removed, thereby making it unnecessary to remove the timing belt (see illustration).

15 Mark the fuel injection pump in relation to the mounting bracket, using a scribe or felt tip pen (see illustration). This will ensure the correct pump timing is retained when refitting.

16 Unscrew the three front mounting nuts, and recover the washers. Unscrew and remove the rear mounting nut and bolt, noting the locations of the washers, and support the injection pump on a block of wood (see illustrations).

17 Release the injection pump sprocket from the pump shaft, as described in Chapter 2B. Note that the sprocket can be left engaged with the timing belt as the pump is withdrawn from its mounting bracket. Refit the M8 bolts to retain the sprocket in position while the pump is removed.

18 Carefully withdraw the pump. Recover the

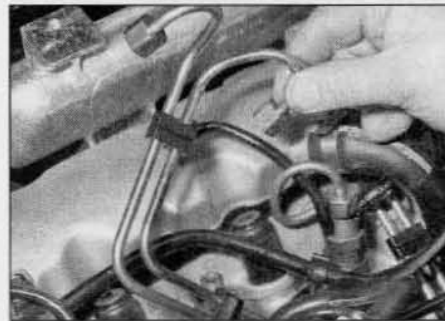

5.12d Removing a fuel pipe assembly

Woodruff key from the end of the pump shaft if it is loose, and similarly recover the bush from the rear of the mounting bracket.

### Refitting

19 Commence refitting the injection pump by fitting the Woodruff key to the shaft groove (if removed).

20 Offer the pump to the mounting bracket, and support on a block of wood, as during removal.

21 Engage the pump shaft with the sprocket, and refit the sprocket as described in Chapter 2B. Ensure that the Woodruff key does not fall out of the shaft as the sprocket is engaged.

22 Align the marks made on the pump and mounting bracket before removal. If a new pump is being fitted, transfer the mark from the old pump to give an approximate setting.

23 Refit and lightly tighten the pump mounting nuts and bolt.

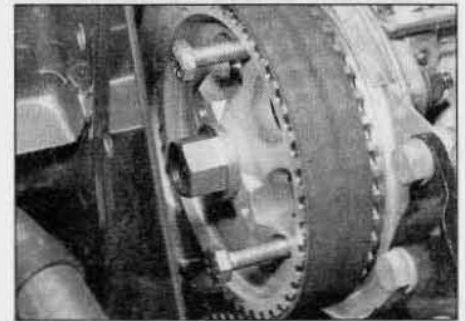

5.14 Bolts inserted through timing holes in injection pump sprocket

24 Set up the injection timing, as described in Sections 6, 7 and 8 (as applicable).

25 Refit and reconnect the injector fuel pipes.

26 Reconnect all relevant wiring to the pump.

27 Reconnect the fuel supply and return hoses, and tighten the unions, as applicable. Use new sealing washers on the banjo unions.

28 Reconnect the fast idle cable, and adjust it as described in Section 4.

29 Reconnect and adjust the accelerator cable with reference to Section 11.

30 Where necessary, reconnect the hoses to the vacuum converter.

31 Refit the upper timing belt covers.

32 Lower the vehicle to the ground.

33 Where applicable, refit the air distribution housing, intake duct, and breather hose

34 Remove the plastic bag used to cover the alternator.

35 Reconnect the battery negative terminal.

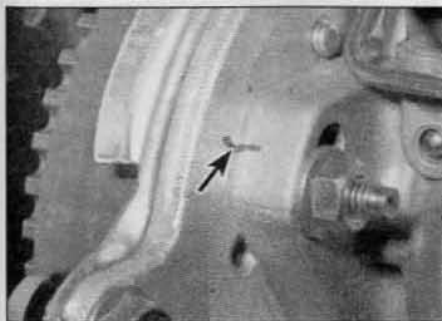

5.15 Mark the injection pump in relation to the mounting bracket (arrowed)

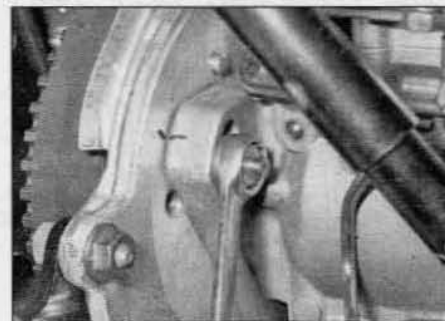

5.16a Unscrewing an injection pump front mounting nut – Bosch pump



5.16b Unscrewing an injection pump rear mounting nut (arrowed) – Bosch pump



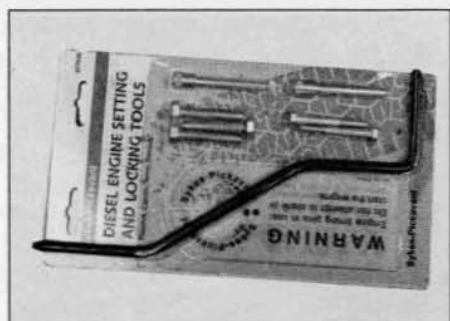

6.3 TDC setting and locking tools for setting injection timing

36 Bleed the fuel system as described in Section 2.

37 Start the engine, and check the fuel injection pump adjustments as described in Section 9.

## 6 Injection timing – checking methods and adjustment

1 Checking the injection timing is not a routine operation. It is only necessary after the injection pump has been disturbed.

2 Dynamic timing equipment does exist, but it is unlikely to be available to the home mechanic. The equipment works by converting pressure pulses in an injector pipe into electrical signals. If such equipment is available, use it in accordance with its maker's instructions.

3 Static timing as described in this Chapter gives good results if carried out carefully. A dial test indicator will be needed, with probes and adaptors appropriate to the type of injection pump (see illustration). Read through the procedures before starting work, to find out what is involved.

## 7 Injection timing (Lucas fuel injection pump) – checking and adjustment

**Caution:** Do not attempt the timing procedure unless accurate instrumentation is available. Suitable special tools for



7.3 Removing the injection pump timing inspection plug – Lucas pump

carrying out pump timing should be available from larger motor factors or your Peugeot/Citroën dealer. Refer to the precautions given in Section 1 of this Chapter before proceeding.

**Note:** To check the injection pump timing a dial gauge (Peugeot/Citroën tool No 2437-T) together with a special timing probe and mounting bracket (Peugeot/Citroën tool No 4093-TJ) is required (see illustration 7.4). Without access to this equipment (or suitable alternatives), injection pump timing should be entrusted to a Peugeot/Citroën dealer or other suitably-equipped specialist.

1 If the injection timing is being checked with the pump in position on the engine unit, rather than as part of the pump refitting procedure, disconnect the battery negative terminal (refer to *Disconnecting the battery* in the Reference Chapter), and cover the alternator with a clean cloth or plastic bag to prevent the possibility of fuel being spilt onto it. Remove the injector pipes as described in paragraph 12 of Section 5.

2 Referring to Chapter 2B, align the engine assembly/valve timing holes to lock the crankshaft in position. Remove the crankshaft locking tool, then turn the crankshaft backwards (anti-clockwise) approximately a quarter of a turn.

3 Unscrew the access plug from the guide on the top of the pump body and recover the sealing washer (see illustration). Insert the special timing probe into the guide, making sure it is correctly seated against the guide sealing washer surface.

**Note:** The timing probe must be seated against the guide sealing washer surface and not the upper lip of the guide for the measurement to be accurate.

4 Mount the bracket on the pump guide and securely mount the dial gauge (dial test indicator) in the bracket so that its tip is in contact with the bracket linkage (see illustration). Position the dial gauge so that

its plunger is at the mid-point of its travel and zero the gauge.

5 Rotate the crankshaft slowly in the correct direction of rotation (clockwise) until the crankshaft locking tool can be re-inserted.

6 With the crankshaft locked in position read the dial gauge; the reading should correspond to the value marked on the pump (there is a tolerance of  $\pm 0.04$  mm). The timing value may be marked on a plastic disc attached to the front of the pump, or alternatively on a tag attached to the pump control lever (see illustration).

7 If adjustment is necessary, slacken the front pump mounting nuts and the rear mounting bolt, then slowly rotate the pump body until the point is found where the specified reading is obtained on the dial gauge. When the pump is correctly positioned, tighten both its front mounting nuts and the rear bolt to their specified torque settings.

8 Withdraw the timing probe slightly, so that it is positioned clear of the pump rotor dowel, and remove the crankshaft locking pin. Rotate the crankshaft through one and three quarter rotations in the normal direction of rotation.

9 Slide the timing probe back into position ensuring that it is correctly seated against the guide sealing washer surface, not the upper lip, then zero the dial gauge.

10 Rotate the crankshaft slowly in the correct direction of rotation until the crankshaft locking tool can be re-inserted. Recheck the timing measurement.

11 If adjustment is necessary, slacken the pump mounting nuts and bolt and repeat the operations in paragraphs 7 to 10.

12 When the pump timing is correctly set, remove the dial gauge and mounting bracket and withdraw the timing probe.

13 Refit the screw and sealing washer to the guide and tighten it securely.

14 If the procedure is being carried out as part of the pump refitting sequence, proceed as described in Section 5.

15 If the procedure is being carried out with the pump fitted to the engine, refit the injector pipes tightening their union nuts to the specified torque setting. Reconnect the battery, then bleed the fuel system – see Section 2. Start the engine and adjust the idle speed and anti-stall speeds as described in Section 9.

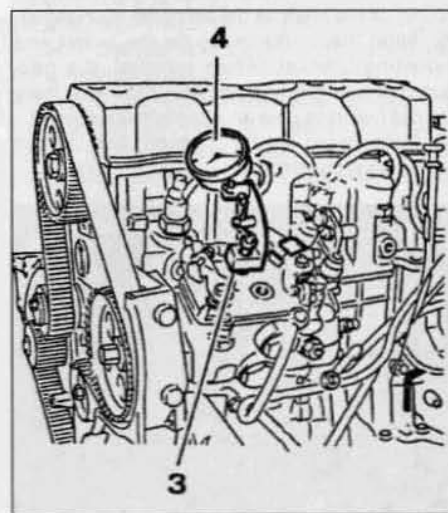

7.4 Injection pump timing dial gauge (4) and mounting bracket (3) in position on the injection pump

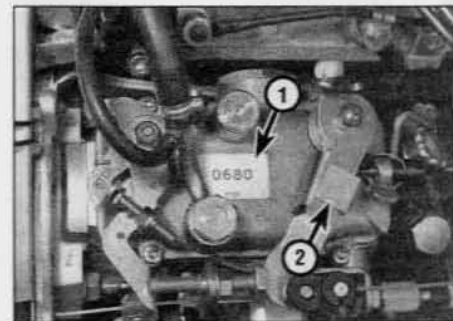

7.6 Pump timing values marked on label (1) and tag (2) – Lucas pump

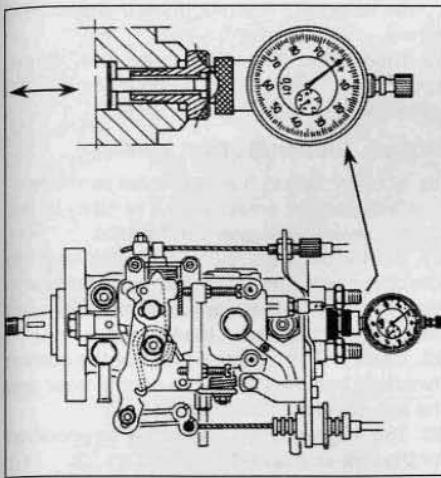

8.8 Dial test indicator, adaptor and timing probe for use with Bosch pump

### 8 Injection timing (Bosch fuel injection pump) – checking and adjustment



**Caution:** Do not attempt the timing procedure unless accurate instrumentation is available. Suitable special tools for carrying out pump timing should be available from larger motor factors or your Peugeot/Citroën dealer. Refer to the precautions given in Section 1 of this Chapter before proceeding.

**Note:** To check the injection pump timing a dial gauge (Peugeot/Citroën tool No 3089-T) together with a special timing probe (Peugeot/Citroën tool No 5003-TD) and adaptor (Peugeot/Citroën tool No 7010-T) is required. Without access to this equipment (or suitable alternatives), injection pump timing should be entrusted to a Peugeot/Citroën dealer or other suitably-equipped specialist.

1 If the injection timing is being checked with the pump in position on the engine unit, rather than as part of the pump refitting procedure,

disconnect the battery negative terminal (refer to *Disconnecting the battery* in the Reference Chapter), and cover the alternator with a clean cloth or plastic bag to prevent the possibility of fuel being spilled onto it.

2 Remove the air inlet duct between the air distribution housing and the air cleaner assembly as described in Section 3.

3 Remove the injector pipes as described in paragraph 12 of Section 5.

4 Disconnect the wiring connectors at the rear of the injection pump.

5 Slacken the clamp screw and/or nut (as applicable) and slide the fast idle cable end fitting arrangement along the cable so that it is no longer in contact with the pump fast idle lever (ie, so the fast idle lever returns to its stop) (see Section 4).

6 Referring to Chapter 2B, align the engine assembly/valve timing holes to lock the crankshaft in position. Remove the crankshaft locking tool, then turn the crankshaft backwards (anti-clockwise) approximately a quarter of a turn.

7 Unscrew the access screw, situated in the centre of the four injector pipe unions, from the rear of the injection pump. As the screw is removed, position a suitable container beneath the pump to catch any escaping fuel. Mop-up any spilled fuel with a clean cloth.

8 Screw the adaptor into the rear of the pump and attach the probe to the dial gauge. Mount the dial gauge and probe in the adaptor (see illustration). If access to the special Peugeot/Citroën tools cannot be gained, suitable alternatives can be purchased from most good motor factors. Position the dial gauge so that its plunger is at the mid-point of its travel and securely tighten the adaptor locknut.

9 Slowly rotate the crankshaft back-and-forth whilst observing the dial gauge, to determine when the injection pump piston is at the bottom of its travel (BDC). When the piston is correctly positioned, zero the dial gauge.

10 Rotate the crankshaft slowly in the correct direction until the crankshaft locking tool can be re-inserted.

11 The reading obtained on the dial gauge should be equal to the specified pump timing measurement given in the Specifications at the start of this Chapter. If adjustment is necessary, slacken the front and rear pump mounting nuts and bolts and slowly rotate the pump body until the point is found where the specified reading is obtained. When the pump is correctly positioned, tighten both its front and rear mounting nuts and bolts securely.

12 Rotate the crankshaft through one and three quarter rotations in the normal direction of rotation. Find the injection pump piston BDC as described in paragraph 6 and zero the dial gauge.

13 Rotate the crankshaft slowly in the correct direction of rotation until the crankshaft locking tool can be re-inserted (bringing the engine back to TDC). Recheck the timing measurement.

14 If adjustment is necessary, slacken the pump mounting nuts and bolts and repeat the operations in paragraphs 11 to 13.

15 When the pump timing is correctly set, unscrew the adaptor and remove the dial gauge and probe.

16 Refit the screw and sealing washer to the pump and tighten it securely.

17 If the procedure is being carried out as part of the pump refitting sequence, proceed as described in Section 5.

18 If the procedure is being carried out with the pump fitted to the engine, refit the injector pipes tightening their union nuts to the specified torque setting. Refit the air intake duct, then reconnect the battery and bleed the fuel system as described in Section 2.

19 Start the engine and adjust the idle speed and anti-stall speeds as described in Section 9. Also adjust the fast idle cable as described in Section 4.

### 9 Fuel injection pump – adjustment



1 The usual type of tachometer (rev counter), which works from ignition system pulses, cannot be used on diesel engines. For the following adjustments to be accurately carried out it will be necessary to purchase or hire an appropriate tachometer, or entrust the work to a Peugeot/Citroën dealer or other suitably-equipped specialist.

2 Before making adjustments, warm-up the engine to normal operating temperature. Make sure that the accelerator cable and fast idle cables are correctly adjusted as described in Sections 11 and 4 respectively.

#### Lucas fuel injection pump

3 With the engine idling, place a shim of the correct thickness (see Specifications), between the pump control lever and the anti-stall adjustment screw (see illustration).

4 Push the manual stop lever back against its stop, and hold it in position by inserting a

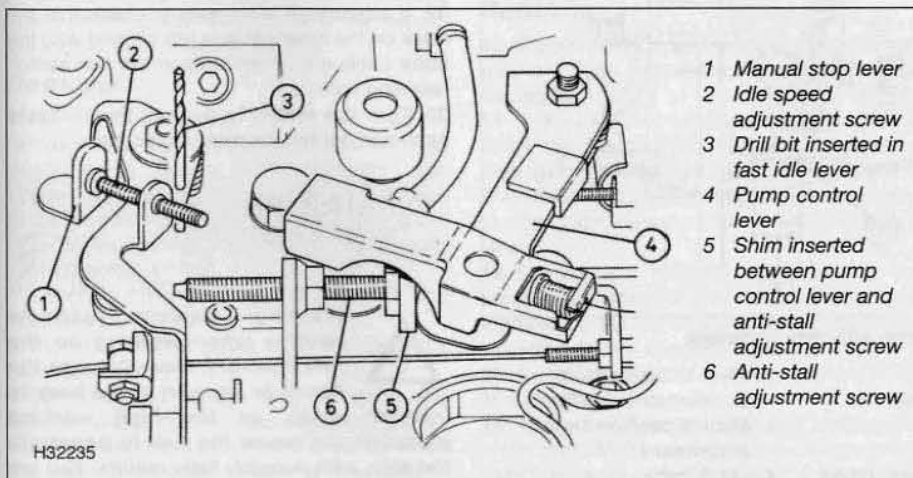

- 1 Manual stop lever
- 2 Idle speed adjustment screw
- 3 Drill bit inserted in fast idle lever
- 4 Pump control lever
- 5 Shim inserted between pump control lever and anti-stall adjustment screw
- 6 Anti-stall adjustment screw

9.3 Lucas fuel injection pump adjustment details



9.0 mm diameter rod/drill through the hole in the fast idle lever.

5 The engine speed should be as specified for the anti-stall speed.

6 If adjustment is necessary, loosen the locknut, turn the anti-stall adjustment screw as required, then tighten the locknut.

7 Remove the rod/drill and the shim, and check that the engine is idling at the specified idle speed.

8 If adjustment is necessary, loosen the locknut on the idle speed adjustment screw. Turn the screw as required, and retighten the locknut.

9 Move the pump control lever to increase the engine speed to approximately 3000 rpm, then quickly release the lever. The deceleration period should be between 2.5 and 3.5 seconds, and the engine speed should drop to approximately 50 rpm below idle.

10 If the deceleration is too fast and the engine stalls, unscrew the anti-stall adjustment screw a quarter-turn towards the control lever. If the deceleration is too slow, resulting in poor engine braking, turn the screw a quarter-turn away from the lever.

11 Retighten the locknut after making an adjustment. Recheck the idle speed, and adjust if necessary as described previously.

12 With the engine idling, check the operation of the manual stop control by turning the stop lever clockwise (see illustration 9.3). The engine must stop instantly.

13 Where applicable, disconnect the tachometer on completion.

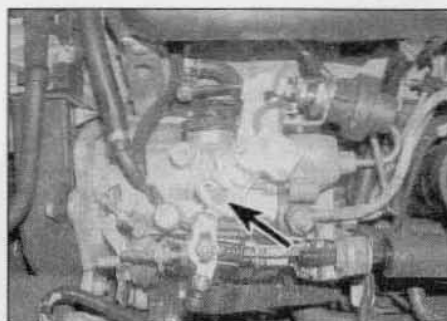

9.17 Throttle position switch operating cam retaining screw (arrowed) – Lucas pump

14 With all the previously described adjustments completed, check the adjustment of the throttle position switch located on the pump control lever as follows.

15 Working at the fuel injection pump end of the accelerator cable, make a mark on the inner cable, 11.0 mm from the end of the outer cable (see illustration 9.20).

16 Have an assistant depress the accelerator pedal until the mark on the inner cable is aligned with the end of the outer cable. With the cable in this position, the throttle position switch contacts should just open.

17 If adjustment is necessary, check that the mark on the inner cable is still aligned with the outer cable end, then slacken the screw securing the plastic operating cam to the pump control lever (see illustration).

18 Move the operating cam until the switch

contacts open, then tighten the securing screw.

19 Disconnect the tachometer and, where applicable, refit the engine cover on completion.

### Bosch fuel injection pump

20 Loosen the locknut, and unscrew the anti-stall adjustment screw until it is clear of the pump control lever (see illustration).

21 Start the engine and allow it to idle. If the idle speed is incorrect, loosen the locknut and turn the idle speed adjustment screw as required, then retighten the locknut.

22 Insert a shim or feeler blade of the correct thickness between the pump control lever and the anti-stall adjustment screw.

23 The engine speed should be as specified for the anti-stall speed.

24 If adjustment is necessary, loosen the locknut and turn the anti-stall adjustment screw as required. Retighten the locknut.

25 Remove the shim or feeler blade and allow the engine to idle.

26 Move the fast idle lever fully towards the flywheel end of the engine, and check that the engine speed increases to the specified fast idle speed. If necessary, loosen the locknut and turn the fast idle adjusting screw as required, then retighten the locknut.

27 With the engine idling, check the operation of the manual stop control by turning the stop lever. The engine must stop instantly.

28 Disconnect the tachometer on completion.

29 With all the previously described adjustments completed, check the adjustment of the throttle position switch located on the pump control lever as follows.

30 Working at the fuel injection pump end of the accelerator cable, make a mark on the inner cable, 11.0 mm from the end of the outer cable.

31 Have an assistant depress the accelerator pedal until the mark on the inner cable is aligned with the end of the outer cable. With the cable in this position, the throttle position switch contacts should just open.

32 If adjustment is necessary, check that the mark on the inner cable is still aligned with the outer cable end, then slacken the two switch retaining screws.

33 Turn the switch body until the contacts open and tighten the retaining screws.

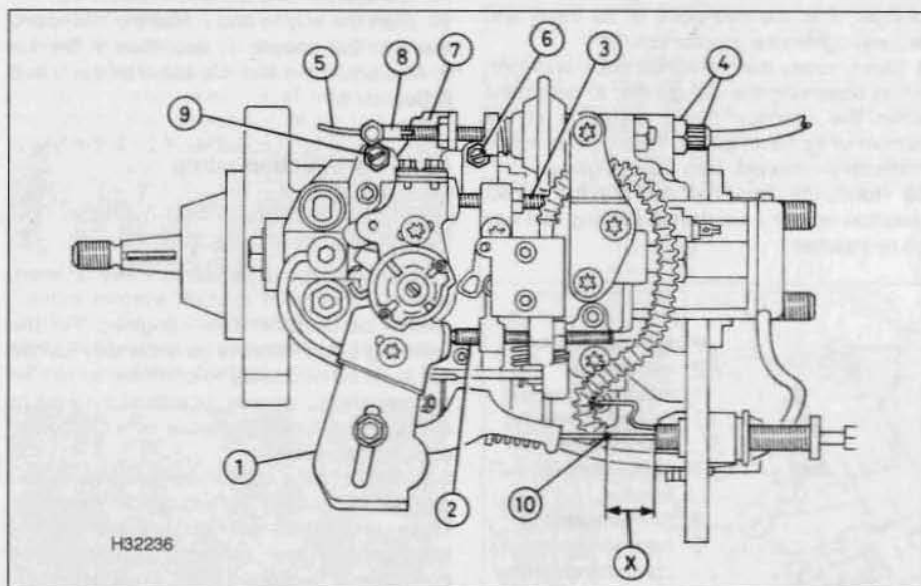

9.20 Bosch fuel injection pump adjustment details

- |                               |                               |                          |
|-------------------------------|-------------------------------|--------------------------|
| 1 Pump control lever          | 5 Fast idle cable             | 10 Mark to be made on    |
| 2 Maximum speed               | 6 Idle speed adjustment       | accelerator cable for    |
| 3 Anti-stall adjustment screw | 7 Fast idle lever             | throttle position switch |
| 4 Fast idle cable adjustment  | 8 Fast idle cable end fitting | adjustment               |
| screw and locknut             | 9 Fast idle adjustment screw  | X = 11.0 mm              |

### 10 Fuel injectors – testing, removal and refitting



**Warning:** Exercise extreme caution when working on the fuel injectors. Never expose the hands or any part of the body to injector spray, as the high working pressure can cause the fuel to penetrate the skin, with possibly fatal results. You are strongly advised to have any work which





10.5 Pulling a leak-off pipe from a fuel injector



10.7 Unscrewing an injector pipe union nut



10.8 Unscrew the injectors, and remove them from the cylinder head



10.9a Removing a fuel injector copper washer ...



10.9b ... fire seal washer ...



10.9c ... and sleeve

*involves testing the injectors under pressure carried out by a dealer or fuel injection specialist.*

### Testing

1 Injectors do deteriorate with prolonged use, and it is reasonable to expect them to need reconditioning or renewal after 60 000 miles (100 000 km) or so. Accurate testing, overhaul and calibration of the injectors must be left to a specialist. A defective injector which is causing knocking or smoking can be located without dismantling as follows.

2 Run the engine at fast idle. Slacken each injector union in turn, placing rag around the union to catch spilt fuel, and being careful not to expose the skin to any spray. When the union on the defective injector is slackened, the knocking or smoking will stop.

### Removal

3 For improved access on 1.9 litre models, remove the air distribution housing as described in Section 3. If necessary, also remove the intake duct, and disconnect the breather hose from the engine oil filler tube. Refer to the relevant Sections of this Chapter for further information.

4 Carefully clean around the injectors and injector pipe union nuts.

5 Pull the leak-off pipes from the injectors (see illustration).

6 Unscrew the union nuts securing the injector pipes to the fuel injection pump. Counterhold the unions on the pump when unscrewing the nuts. Cover open unions to keep dirt out, using small plastic bags, or

fingers cut from clean rubber gloves.

7 Unscrew the union nuts and disconnect the pipes from the injectors (see illustration). If necessary, the injector pipes may be completely removed. Note carefully the locations of the pipe clamps, for use when refitting. Cover the ends of the injectors, to prevent dirt ingress.

8 Unscrew the injectors using a deep socket or box spanner (27 mm across-flats), and remove them from the cylinder head (see illustration).

9 Recover the copper washers and fire seal washers from the cylinder head. Also recover the sleeves if they are loose (see illustrations).

### Refitting

10 Obtain new copper washers and fire seal washers. Also renew the sleeves, if they are damaged.

11 Take care not to drop the injectors, or allow the needles at their tips to become damaged. The injectors are precision-made to fine limits, and must not be handled roughly. In particular, never mount them in a bench vice.

12 Commence refitting by inserting the sleeves (if removed) into the cylinder head, followed by the fire seal washers (convex face uppermost), and copper washers.

13 Insert the injectors and tighten them to the specified torque.

14 Refit the injector pipes and tighten the union nuts. Make sure the pipe clamps are in their previously-noted positions. If the clamps are wrongly positioned or missing, problems

may be experienced with pipes breaking or splitting.

15 Reconnect the leak-off pipes.

16 Refit the components removed for access with reference to the relevant Sections of this Chapter.

17 Start the engine. If difficulty is experienced, bleed the fuel system as described in Section 2.

## 11 Accelerator cable – removal, refitting and adjustment

### Removal

1 Working in the engine compartment, operate the pump control lever on the fuel injection pump, and release the cable inner from the lever (see illustration).



11.1 Releasing the accelerator inner cable from the lever on the injection pump



**11.2 Pulling the accelerator outer cable from the bracket**

- 2 Pull the cable out from the grommet in the fuel injection pump bracket (**see illustration**).
- 3 Release the cable from the remaining clips and brackets in the engine compartment, noting its routing.
- 4 Working inside the car, remove the fusebox cover and the undercover from beneath the fascia on the driver's side.
- 5 Reach up under the fascia, depress the ends of the cable end fitting and detach the inner cable from the top of the accelerator pedal. Where fitted, pull out the clip securing the bulkhead grommet.
- 6 Tie a length of string to the end of the cable.
- 7 Return to the engine compartment, release the cable grommet from the bulkhead and withdraw the cable. When the end of the cable appears, untie the string and leave it in position – it can then be used to draw the cable back into position on refitting.

#### Refitting

- 8 Tie the string to the end of the cable, then use the string to draw the cable into position through the bulkhead. Once the cable end is visible, untie the string, then attach the inner cable to the pedal. Where applicable, refit the bulkhead grommet clip.
- 9 From within the engine compartment, ensure the outer cable is correctly seated in the bulkhead grommet, then work along the cable, securing it in position with the retaining clips and ties, and ensuring that the cable is correctly routed.
- 10 Pass the outer cable through its mounting bracket grommet, and reconnect the inner cable to the injection pump lever. Adjust the cable as described below.

#### Adjustment

- 11 Remove the spring clip from the accelerator outer cable. Ensuring that the control lever is against its stop, gently pull the cable out of its grommet until all free play is removed from the inner cable.
- 12 With the cable held in this position, refit the spring clip to the last exposed outer cable groove in front of the rubber grommet and washer. When the clip is refitted and the outer cable is released, there should be only a small amount of free play in the inner cable.
- 13 Have an assistant depress the accelerator pedal, and check that the control lever opens fully and returns smoothly to its stop.

#### 12 Accelerator pedal – removal and refitting

Refer to Chapter 4A, Section 4, but adjust the accelerator cable as described in Section 11.

#### 13 Fuel gauge sender and pick-up unit – removal and refitting

- 1 The fuel gauge sender and pick-up unit is located in the same position as the fuel pump on petrol models and the removal and refitting procedures are virtually identical. Refer to Chapter 4A, Section 8.
- 2 On completion, bleed the fuel system as described in Section 2.

#### 14 Fuel tank – removal and refitting

Refer to Chapter 4A, Section 10.

#### 15 Manifolds – removal and refitting

**Note:** Renew the manifold gasket(s) when refitting.

##### Inlet manifold

##### Removal

- 1 Disconnect the battery negative terminal (refer to *Disconnecting the battery* in the Reference Chapter).
- 2 Remove the air intake duct and, on 1.9 litre engines, the air distribution housing as described in Section 3.
- 3 Undo the six nuts securing the manifold flanges to the cylinder head, and the single hexagonal bolt from the centre flange. Recover the washers from the manifold studs, where fitted.
- 4 Withdraw the manifold from the cylinder head and collect the gaskets.

##### Refitting

- 5 Refitting is a reversal of removal, bearing in mind the following points.
  - a) Renew the gasket(s) when refitting the manifold.
  - b) Refit the air distribution housing and/or air intake duct as described in Section 3.

##### Exhaust manifold

##### Removal

- 6 Remove the inlet manifold as described previously.
- 7 Disconnect the exhaust front pipe from the manifold, with reference to Section 16.

8 On certain models, it may be necessary to unbolt the resonator chamber from the manifold, to allow sufficient clearance for the manifold to be removed.

9 On DJY (XUD9Y engine) models, remove the exhaust gas recirculation (EGR) valve from the exhaust manifold as described in Part D of this Chapter.

10 Unscrew the six exhaust manifold securing nuts, and recover the spacers from the studs.

11 Lift the exhaust manifold from the cylinder head, and recover the gaskets.

12 It is possible that some of the manifold studs may be unscrewed from the cylinder head when the manifold securing nuts are unscrewed. In this event, the studs should be screwed back into the cylinder head once the manifolds have been removed, using two manifold nuts locked together.

##### Refitting

13 Refitting is a reversal of removal, bearing in mind the following points.

- a) Renew the manifold gaskets.
- b) Reconnect the exhaust front pipe to the exhaust manifold as described in Section 16.
- c) Where applicable, refit the EGR valve as described in Part D of this Chapter.
- d) Ensure that all relevant hoses and pipes are correctly reconnected and routed.

#### 16 Exhaust system – general information and component renewal

##### General information

1 The exhaust system consists of two sections: the front pipe and the tailpipe. The front pipe to manifold joint is of the spring-loaded ball type, to allow for movement in the exhaust system, and the tailpipe joint is secured by a clamping ring.

2 The system is suspended throughout its entire length by rubber mountings.

##### Removal

3 Each exhaust section can be removed individually or, alternatively, the complete system can be removed as a unit. Even if only one part of the system needs attention, it is often easier to remove the whole system and separate the sections on the bench.

4 To remove the system or part of the system, first jack up the front or rear of the car, and support it on axle stands (see *Jacking and vehicle support*). Alternatively, position the car over an inspection pit, or on car ramps.

##### Front pipe

5 Slacken the front pipe clamping ring bolts, and disengage the clamp from the flange joint.

6 Slacken and remove the two nuts securing the front pipe flange joint to the manifold, and



recover the spring cups and springs (**see illustration**). Remove the bolts, then free the front pipe from its mounting rubber(s) and remove it from underneath the vehicle. Recover the wire-mesh gasket from the manifold joint.

**Tailpipe**

7 Slacken the tailpipe clamping ring bolts, and disengage the clamp from the flange joint.

8 Unhook the tailpipe from its mounting rubbers, and remove it from the vehicle.

**Complete system**

9 Slacken and remove the two nuts securing the front pipe flange joint to the manifold, and recover the spring cups and springs. Remove the bolts, then free the system from its mounting rubbers and remove it from underneath the vehicle. Recover the wire-mesh gasket from the manifold joint.

**Heat shield(s)**

10 The heat shields are secured to the underside of the body by various nuts and bolts. Each shield can be removed once the

relevant exhaust section has been removed. If a shield is being removed to gain access to a component located behind it, it may prove sufficient in some cases to remove the retaining nuts and/or bolts, and simply lower the shield, without disturbing the exhaust system.

**Refitting**

11 Each section is refitted by reversing the removal sequence, noting the following points:

- a) *Ensure that all traces of corrosion have been removed from the flanges, and renew all necessary gaskets.*
- b) *Inspect the rubber mountings for signs of damage or deterioration, and renew as necessary.*
- c) *Prior to assembling the spring-loaded joint, a smear of high-temperature grease should be applied to the joint mating surfaces.*
- d) *Where joints are secured together by a clamping ring, apply a smear of exhaust system jointing paste to the flange joint, to ensure a gas-tight seal. Tighten the*

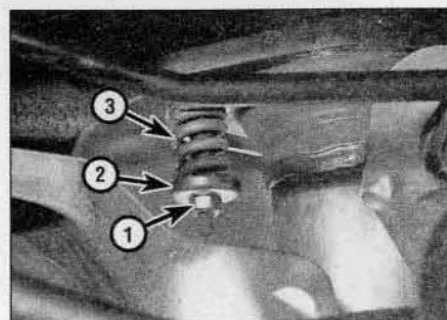

**16.6 Exhaust front pipe-to-manifold securing nut (1), spring seat (2) and spring (3) – viewed from underneath vehicle**

*clamping ring nuts evenly and progressively, so that the clearance between the clamp halves remains equal on either side.*

- e) *Prior to tightening the exhaust system fasteners, ensure that all rubber mountings are correctly located, and that there is adequate clearance between the exhaust system and vehicle underbody.*



Faint, illegible text in the left column, likely bleed-through from the reverse side of the page.

Faint, illegible text in the left column, likely bleed-through from the reverse side of the page.

Faint, illegible text in the left column, likely bleed-through from the reverse side of the page.

Faint, illegible text in the top middle column, likely bleed-through from the reverse side of the page.

Faint, illegible text in the middle column, likely bleed-through from the reverse side of the page.

Faint, illegible text in the middle column, likely bleed-through from the reverse side of the page.

Faint, illegible text in the middle column, likely bleed-through from the reverse side of the page.

Faint, illegible text in the middle column, likely bleed-through from the reverse side of the page.

Faint, illegible text in the top right column, likely bleed-through from the reverse side of the page.

Faint, illegible text in the middle right column, likely bleed-through from the reverse side of the page.

Faint, illegible text in the middle right column, likely bleed-through from the reverse side of the page.

Faint, illegible text in the middle right column, likely bleed-through from the reverse side of the page.

Faint, illegible text in the middle right column, likely bleed-through from the reverse side of the page.



# Chapter 4 Part C:

## Fuel and exhaust systems – 1.9 and 2.0 litre (DW series) diesel models

### Contents

	Section number		Section number
Accelerator cable – removal, refitting and adjustment	4	Fuel injectors – removal and refitting	15
Accelerator pedal – removal and refitting	5	Fuel rail (2.0 litre models) – removal and refitting	16
Air cleaner assembly and intake ducts – removal and refitting	3	Fuel supply pump (2.0 litre models) – removal and refitting	7
Air cleaner element filter renewal	.See Chapter 1B	Fuel system – priming and bleeding	6
Exhaust manifold – removal and refitting	18	Fuel tank – removal and refitting	9
Exhaust system – general information, removal and refitting	21	General information	1
Fast idle thermostatic sensor (1.9 litre models) – removal, refitting and adjustment	10	High pressure Diesel injection system – special information	2
Fuel filter renewal	.See Chapter 1B	Injection system electrical components – removal and refitting	12
Fuel filter water draining	.See Chapter 1B	Injection timing – checking and adjustment	14
Fuel gauge sender unit – removal and refitting	8	Inlet manifold – removal and refitting	17
Fuel injection pump (1.9 litre models) – adjustment	11	Turbocharger (2.0 litre models) – description and precautions	19
Fuel injection pump – removal and refitting	13	Turbocharger (2.0 litre models) – removal, inspection and refitting	20

### Degrees of difficulty

**Easy**, suitable for novice with little experience



**Fairly easy**, suitable for beginner with some experience



**Fairly difficult**, suitable for competent DIY mechanic



**Difficult**, suitable for experienced DIY mechanic



**Very difficult**, suitable for expert DIY or professional



### Specifications

#### General

##### System type:

##### 1.9 litre models:

Engine code WJZ .....

Engine code WJY .....

2.0 litre models .....

Indirect injection system incorporating a distributor fuel injection pump  
Indirect injection system incorporating a semi-electronically controlled distributor fuel injection pump

High-pressure Diesel injection (HDI) direct injection 'common-rail' system incorporating an electronically controlled fuel injection pump and injectors

##### Injection pump type:

##### 1.9 litre models:

Engine code WJZ .....

Engine code WJY .....

2.0 litre models .....

Bosch VE 4/9 or Lucas DWLP 11

Lucas DWLP12

Bosch EDC 15C2 or Siemens SID 801

#### Injectors

##### Opening pressure:

1.9 litre models .....

2.0 litre models .....

133 to 138 bars

Controlled by ECU

#### Turbocharger

Type .....

KKK K03

Boost pressure (approximate) .....

1 bar at 3000 rpm

**Adjustment data**

Idle speed – 1.9 litre models\*:

Engine code WJZ:

Lucas injection pump:

Models without air conditioning .....	825 ± 25 rpm
Models with air conditioning .....	875 ± 25 rpm

Bosch injection pump:

Models without air conditioning .....	800 ± 25 rpm
Models with air conditioning .....	875 ± 25 rpm

Engine code WJY .....

850 ± 25 rpm

Idle speed – 2.0 litre models .....

800 ± 20 rpm – controlled by ECU

Anti-stall speed – 1.9 litre models:

Lucas injection pump .....

1500 ± 100 rpm

Bosch injection pump:

Models without air conditioning .....	800 +20 +50 rpm
Models with air conditioning .....	875 +20 +50 rpm

Anti-stall shim thickness:

With Lucas injection pump .....

3.0 mm

With Bosch injection pump .....

1.0 mm

Fast idle speed – 1.9 litre models\*:

Engine code WJZ .....

950 ± 25 rpm

Engine code WJY .....

1150 ± 25 rpm

Maximum speed:

1.9 litre models .....

5350 ± 125 rpm

2.0 litre models .....

5000 rpm – controlled by ECU

\*Refer to Chapter 2C for further information on engine code identification

**Torque wrench settings****1.9 litre models**

	Nm	lbf ft
Exhaust manifold nuts .....	30	22
Fuel pipe union nuts .....	25	18
Inlet manifold:		
Lower section nuts/bolts .....	20	15
Upper section:		
M6 bolts .....	8	6
M8 bolts .....	18	13
Injection pump:		
Front mounting bolts .....	20	15
Rear mounting bolt .....	23	17
Mounting bracket-to-cylinder head bolts .....	20	15
Injection pump sprocket-to-hub bolts .....	23	17
Injectors to cylinder head .....	90	66

**2.0 litre models**

EGR valve bolts .....	10	7
Exhaust manifold nuts .....	20	15
Fuel filter bracket bolts .....	18	13
Fuel pipe union nuts .....	20	15
Fuel pressure sensor .....	35	26
Fuel rail mounting bolts .....	23	17
Inlet manifold nuts and bolts .....	23	17
Injection pump:		
Front mounting bolts/nut .....	23	17
Rear bracket bolts .....	20	15
Mounting bracket-to-cylinder head bolts .....	20	15
Injector retaining clamp nut .....	30	22
Turbocharger:		
Mounting nuts .....	25	18
Exhaust flange bolts .....	23	17
Support bracket:		
Bracket-to-cylinder block bolts .....	23	17
Bracket-to-turbo bolt .....	30	22
Oil feed pipe:		
Pipe-to-turbo union bolt .....	22	16
Pipe-to-cylinder block union nut .....	48	35
Oil return hose union bolts .....	12	9

## 1 General information

### 1.9 litre WJZ engine models

1 The fuel system consists of a fuel tank (which is mounted under the rear of the car), a fuel filter with integral water separator, a fuel injection pump, injectors and associated components.

2 The injection pump draws fuel from the tank through the fuel filter, which is mounted on the thermostat housing on the left-hand end of the cylinder head. The fuel filter removes all foreign matter and water, and ensures that the fuel supplied to the injection pump is clean. Excess fuel is returned from the bleed outlet on the filter housing lid to the tank. The filter housing incorporates a thermostat. When the temperature of the fuel in the filter housing is below 15°C, the filter housing thermostat opens and allows the fuel to circulate between the filter housing and thermostat housing which effectively warms the fuel. When the fuel in the filter housing reaches 35°C, the thermostat closes.

3 The fuel injection pump is driven at half-crankshaft speed by the timing belt. The high pressure required to inject the fuel into the compressed air in the swirl chambers is achieved by two opposed pistons forced together by rollers running in a cam ring. The fuel passes through a central rotor with a single outlet drilling which aligns with ports leading to the injector pipes.

4 Fuel metering is controlled by a centrifugal governor, which reacts to accelerator pedal position and engine speed. The governor is linked to a metering valve, which increases or decreases the amount of fuel delivered at each pumping stroke.

5 Basic injection timing is determined when the timing belt is fitted. When the engine is running, it is varied automatically to suit the prevailing engine speed by a mechanism which turns the cam plate or ring.

6 The four fuel injectors produce a homogeneous spray of fuel into the swirl chambers located in the cylinder head. The injectors are calibrated to open and close at critical pressures to provide efficient and even combustion. Each injector needle is lubricated by fuel, which accumulates in the spring chamber and is channelled to the injection pump return hose by leak-off pipes.

7 Cold starting is assisted by preheater or 'glow' plugs fitted to each swirl chamber. A thermostatic sensor in the cooling system operates a fast idle lever on the injection pump to increase the idling speed when the engine is cold.

8 A stop solenoid cuts the fuel supply to the injection pump rotor when the ignition is switched off, and there is also a hand-operated stop lever for use in an emergency (see illustration).

9 Provided that the specified maintenance is carried out, the fuel injection equipment will give long and trouble-free service. The injection pump itself may well outlast the engine. The main potential cause of damage to the injection pump and injectors is dirt or water in the fuel.

10 A catalytic converter and exhaust gas recirculation (EGR) system are fitted to the engine to reduce exhaust emissions. Refer to Part D of this Chapter for further information.

11 Servicing of the injection pump and injectors is very limited for the home mechanic, and any dismantling or adjustment other than that described in this Chapter must be entrusted to a Peugeot/Citroën dealer or fuel injection specialist.



**Warning:** It is necessary to take certain precautions when working on the fuel system components, particularly the fuel injectors. Before carrying out any operations on the fuel system, refer to the precautions given in 'Safety first!' at the beginning of this manual, and to any additional warning notes at the start of the relevant Sections.

### 1.9 litre WJY engine models

12 Later 1.9 litre engines (WJY) are fitted with an electronically controlled fuel injection pump to improve emissions in order to meet the next level of emission standards being introduced. The fuel system is very similar to that described in paragraphs 1 to 1.1, with the following changes to the injection pump.

13 The fuel injection pump electrical control system consists of the ECU, along with the following sensors:

- a) Throttle potentiometer – informs the injection pump accelerator lever position, and the rate of throttle opening/closing.
- b) Airflow meter (incorporating the intake air temperature sensor – informs the ECU of the amount and temperature of air passing through the intake duct.
- c) Coolant temperature sensor – informs the ECU of engine temperature.
- d) Crankshaft sensor – informs the ECU of the crankshaft position and speed of rotation.
- e) Vehicle speed sensor – informs the ECU of the vehicle speed.
- f) Injector needle lift sensor – informs the ECU when the start of injection occurs at No 1 injector.
- g) Atmospheric pressure sensor (incorporated in the ECU) – measures the atmospheric pressure to prevent problems when driving at high-altitude.

14 All the above signals are analysed by the ECU which controls the injection timing via the advance solenoid valve which is fitted to the injection pump. By opening and closing the solenoid valve, the ECU can advance and retard the injection timing as necessary. When the advance solenoid is open, the hydraulic pressure on the pump piston is reduced which results in the injection timing being retarded. To advance the injection timing, the ECU closes the solenoid valve which increases the pressure on the piston.

15 The ECU also controls the exhaust gas recirculation (EGR) system, described in detail in Part D of this Chapter, and the engine cooling fan.

16 If there is an abnormality in any of the readings obtained from the various sensors, the ECU enters its back-up mode. In this event, it ignores the abnormal sensor signal and assumes a preprogrammed value which will allow the engine to continue running (albeit at reduced efficiency). If the ECU enters this back-up mode, the warning light on the instrument panel will come on, and the

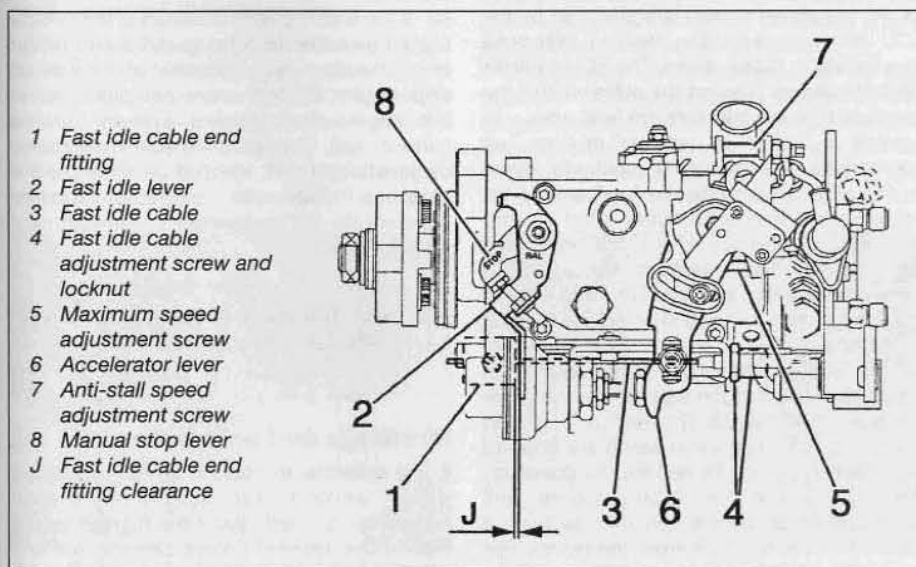

1.8 Lucas injection pump details – 1.9 litre WJZ engine models



relevant fault code will be stored in the ECU memory.

**17** If the warning light illuminates, the vehicle should be taken to a Peugeot/Citroën dealer or engine diagnostic specialist at the earliest opportunity. Once there, a complete test of the engine management system can be carried out, using a special electronic diagnostic test unit, which is plugged into the system's diagnostic connector located adjacent to the passenger's compartment fusebox.



**Warning:** It is necessary to take certain precautions when working on the fuel system components, particularly the

**fuel injectors. Before carrying out any operations on the fuel system, refer to the precautions given in 'Safety first!' at the beginning of this manual, and to any additional warning notes at the start of the relevant Sections.**

## 2.0 litre models

**18** All 2.0 litre engines are fitted with a high-pressure diesel injection (HDI) system which incorporates the very latest in diesel injection technology. On the HDi system, the injection pump is used purely to provide the pressure required for the injection system and has no control over the injection timing (unlike conventional diesel injection systems). The injection timing is controlled by the electronic control unit (ECU) via the electrically-operated injectors. The system operates as follows.

**19** The fuel system consists of a fuel tank (which is mounted under the rear of the car, with an electric fuel supply pump immersed in it on the Bosch system), a fuel filter with integral water separator, a fuel injection pump, injectors and associated components.

**20** Fuel is supplied to the fuel filter housing which is located at the front of the engine. The fuel filter removes all foreign matter and water and ensures that the fuel supplied to the injection pump is clean. Excess fuel is returned from the outlet on the filter housing lid to the tank via the fuel cooler. The fuel cooler is fitted to the underside of the vehicle and is cooled by the passing airflow to ensure the fuel is cool before it enters the fuel tank.

**21** The fuel is heated to ensure no problems occur when the ambient temperature is very low. On early models the filter housing is connected to the coolant outlet housing on the left-hand end of the cylinder head and is fitted with a thermostat. When the temperature of the fuel in the filter housing is below 15°C, the filter housing thermostat opens and allows the fuel to circulate around the coolant outlet housing which effectively warms the fuel. When the fuel in the filter housing reaches 25°C, the thermostat closes. On later models an electrically-operated fuel heater is fitted to the fuel feed pipe to the filter housing, the heater is controlled by the ECU.

**22** The fuel injection pump is driven at half-crankshaft speed by the timing belt. The high

pressure required in the system (up to 1350 bar) is produced by the three pistons in the pump. The injection pump supplies high pressure fuel to the fuel rail, which acts as a reservoir for the four injectors. Since the injection pump has no control over the injection timing (unlike conventional diesel injection systems), this means that there is no need to time the injection pump when installing the timing belt.

**23** The electrical control system consists of the ECU, along with the following sensors:

- a) *Accelerator pedal position sensor – informs the ECU of the accelerator pedal position, and the rate of throttle opening/closing.*
- b) *Coolant temperature sensor – informs the ECU of engine temperature.*
- c) *Airflow meter (incorporating the intake air temperature sensor – informs the ECU of the amount and temperature of air passing through the intake duct.*
- d) *Crankshaft sensor – informs the ECU of the crankshaft position and speed of rotation.*
- e) *Camshaft position sensor – informs the ECU of the positions of the pistons.*
- f) *Fuel temperature sensor (where fitted) – informs the ECU of the temperature of the fuel in the fuel rail.*
- g) *Fuel pressure sensor – informs the ECU of the fuel pressure present in the fuel rail.*
- h) *Atmospheric pressure sensor (incorporated in the ECU) – measures the atmospheric pressure to prevent problems when driving at high-altitude.*
- i) *Vehicle speed sensor – informs the ECU of the vehicle speed.*
- j) *Power steering pressure switch – informs the ECU when the power steering pump is under load.*
- k) *Air conditioning system relay – informs ECU when the air conditioning compressor is under load.*

**24** All the above signals are analysed by the ECU which selects the fuelling response appropriate to those values. The ECU controls the fuel injectors (varying the pulse width – the length of time the injectors are held open – to provide a richer or weaker mixture, as appropriate). The mixture is constantly varied by the ECU, to provide the best setting for cranking, starting (with either a hot or cold engine), warm-up, idle, cruising and acceleration. The injectors are operated 'semi-sequentially', injectors No 1 and 4 being operated as one pair and injectors No 2 and 3 as the other.

**25** The ECU also has full control over the fuel pressure present in the fuel rail via the high-pressure fuel regulator and third piston deactivator solenoid valve which are fitted to the injection pump. To reduce the pressure, the ECU opens the high-pressure fuel regulator which allows the excess fuel to return direct to the tank from the pump. The third piston deactivator is used mainly to reduce the load on the engine, but can also be

used to lower the fuel pressure. The deactivator solenoid valve relieves the fuel pressure from the third piston of the pump which results in only two of the pistons pressurising the fuel system.

**26** The ECU also controls the exhaust gas recirculation (EGR) system, described in detail in Part D of this Chapter, and the engine cooling fan.

**27** A turbocharger is fitted to increase engine efficiency. It does this by raising the pressure in the inlet manifold above atmospheric pressure. Instead of the air simply being sucked into the cylinders, it is forced in.

**28** Energy for the operation of the turbocharger comes from the exhaust gas. The gas flows through a specially-shaped housing (the turbine housing) and in so doing, spins the turbine wheel. The turbine wheel is attached to a shaft, at the end of which is another vaned wheel known as the compressor wheel. The compressor wheel spins in its own housing, and compresses the inlet air on the way to the inlet manifold. The turbo shaft is pressure-lubricated by an oil feed pipe from the main oil gallery. The shaft 'floats' on a cushion of oil. A drain pipe returns the oil to the sump. Boost pressure (the pressure in the inlet manifold) is limited by a wastegate, which diverts the exhaust gas away from the turbine wheel in response to a pressure-sensitive actuator.

**29** If there is an abnormality in any of the readings obtained from the various sensors, the ECU enters its back-up mode. In this event, it ignores the abnormal sensor signal and assumes a preprogrammed value which will allow the engine to continue running (albeit at reduced efficiency). If the ECU enters this back-up mode, the warning light on the instrument panel will come on, and the relevant fault code will be stored in the ECU memory.

**30** If the warning light illuminates, the vehicle should be taken to a Peugeot/Citroën dealer or engine diagnostic specialist at the earliest opportunity. Once there, a complete test of the engine management system can be carried out, using a special electronic diagnostic test unit, which is plugged into the system's diagnostic connector located adjacent to the passenger's compartment fusebox.

## 2 High pressure Diesel injection system – special information

### Warnings and precautions

**1** It is essential to observe strict precautions when working on the fuel system components, particularly the high pressure side of the system. Before carrying out any operations on the fuel system, refer to the precautions given in *Safety first!* at the



2.4 Typical plastic plug and cap set for sealing disconnected fuel pipes and components

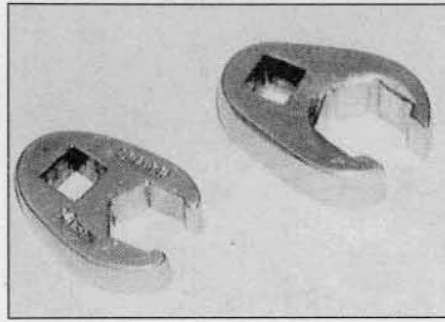

2.7 Two crow-foot adaptors will be necessary for tightening the fuel pipe unions

beginning of this manual, and to the following additional information.

- **Do not carry out any repair work on the high pressure fuel system unless you are competent to do so, have all the necessary tools and equipment required, and are aware of the safety implications involved.**
- **Before starting any repair work on the fuel system, wait at least 30 seconds after switching off the engine to allow the fuel circuit to return to atmospheric pressure.**
- **Never work on the high pressure fuel system with the engine running.**
- **Keep well clear of any possible source of fuel leakage, particularly when starting the engine after carrying out repair work. A leak in the system could cause an extremely high pressure jet of fuel to escape, which could result in severe personal injury.**
- **Never place your hands or any part of your body near to a leak in the high pressure fuel system.**
- **Do not use steam cleaning equipment or compressed air to clean the engine or any of the fuel system components.**

### Repair procedures and general information

2 Strict cleanliness must be observed at all times when working on any part of the fuel system. This applies to the working area in general, the person doing the work, and the components being worked on.

3 Before working on the fuel system components, they must be thoroughly

cleaned with a suitable degreasing fluid. Peugeot/Citroën recommend the use of a specific product (SODIMAC degreasing fluid – available from Peugeot/Citroën dealers). Alternatively, a suitable brake cleaning fluid may be used. Cleanliness is particularly important when working on the fuel system connections at the following components:

- a) Fuel filter.
- b) Injection pump.
- c) Fuel rail.
- d) Fuel injectors.
- e) High pressure fuel pipes.

4 After disconnecting any fuel pipes or components, the open union or orifice must be immediately sealed to prevent the entry of dirt or foreign material. Plastic plugs and caps in various sizes are available in packs from motor factors and accessory outlets, and are particularly suitable for this application (see illustration). Fingers cut from disposable rubber gloves should be used to protect components such as fuel pipes, fuel injectors and wiring connectors, and can be secured in place using elastic bands. Suitable gloves of this type are available at no cost from most petrol station forecourts.

5 Whenever any of the high pressure fuel pipes are disconnected or removed, a new pipe(s) must be obtained for refitting.

6 On the completion of any repair on the high pressure fuel system, Peugeot/Citroën recommend the use of ARDROX 9D1 BRENT leak-detecting compound. This is a powder which is applied to the fuel pipe unions and connections and turns white when dry. Any

leak in the system will cause the product to darken indicating the source of the leak.

7 The torque wrench settings given in the Specifications must be strictly observed when tightening component mountings and connections. This is particularly important when tightening the high pressure fuel pipe unions. To enable a torque wrench to be used on the fuel pipe unions, two crow-foot adaptors are required (Peugeot/Citroën special tools (-). 1603-G and (-). 1603-F). Suitable alternatives are available from motor factors and accessory outlets (see illustration).

### 3 Air cleaner assembly and intake ducts – removal and refitting

#### Removal – 1.9 litre models

##### WJZ engine models

- 1 Release the fasteners from the right-hand side and top of the engine cover then lift off the cover, taking care not to lose its mounting rubbers (see illustrations).
- 2 Slacken and remove the two bolts securing the air intake duct to the front body panel. Slacken the retaining clip then detach the duct from the side of the air cleaner and remove it from the vehicle.
- 3 Slacken the retaining clips securing the inlet duct to the air cleaner lid and EGR valve housing. Undo the mounting bolt at the base of the resonator, then disconnect the duct and remove it from the engine.
- 4 Undo the bolt securing the base of the air cleaner housing to the support bracket. Lift up the housing, disengage the front locating pegs and remove it from the vehicle.

##### WJY engine models – pre-September 2002

- 5 Release the fasteners from the right-hand side and top of the engine cover then lift off the cover, taking care not to lose its mounting rubbers (see illustrations 3.1a to 3.1c).
- 6 Disconnect the battery negative terminal (refer to *Disconnecting the battery* in the Reference Chapter).
- 7 Slacken the retaining clips securing the inlet

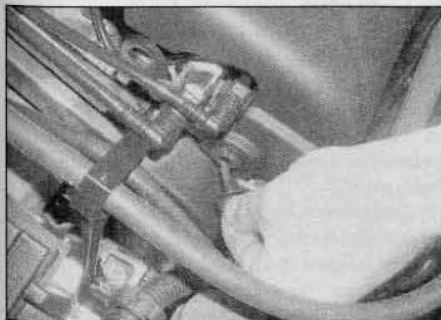

3.1a Remove the fasteners from the right-hand side ...



3.1b ... and top of the engine cover ...



3.1c ... then remove the cover from the engine – 1.9 litre models



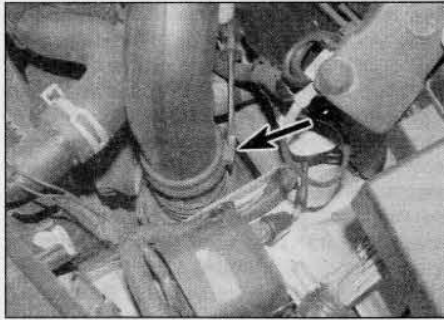

3.7a Slacken the clip (arrowed) securing the inlet duct to the airflow meter ...

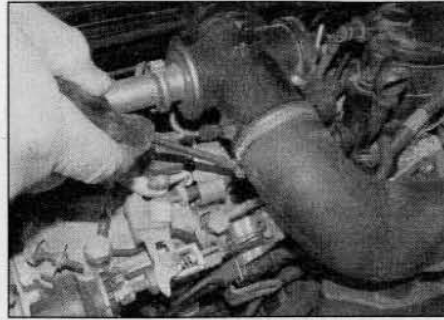

3.7b ... and to the EGR valve housing ...

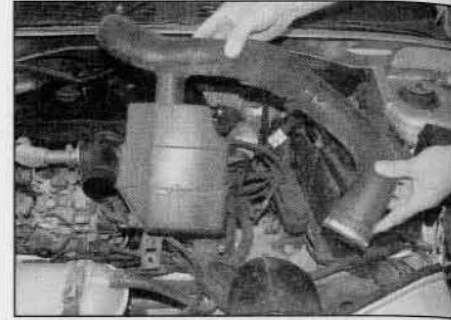

3.7c ... then undo the resonator mounting bolt and remove the duct from the engine – early 1.9 litre models

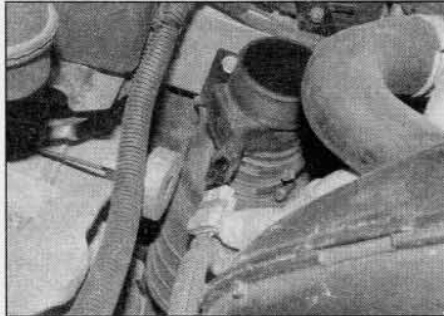

3.8 Disconnect the wiring connector from the airflow meter – early 1.9 litre models

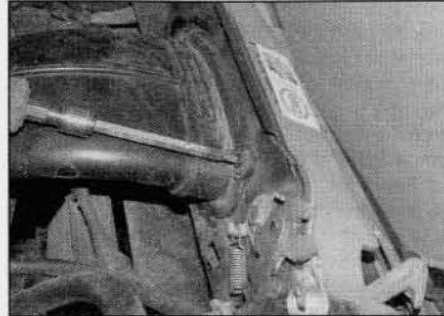

3.9 Undo the screw securing the air intake duct to the front body panel – early 1.9 litre models

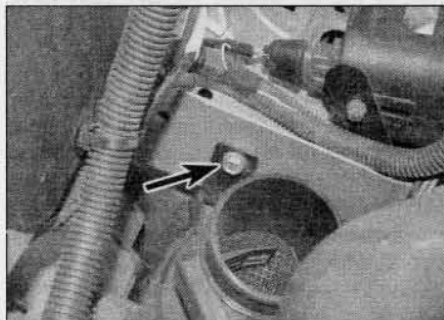

3.10 Undo the bolt (arrowed) securing the air cleaner upper mounting bracket to the body sidemember – early 1.9 litre models

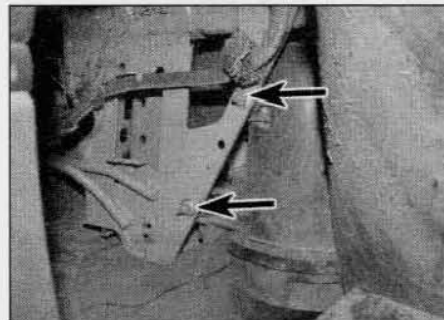

3.13 Air cleaner lower retaining nuts (arrowed) – early 1.9 litre models



3.15 Undo the nut (arrowed) securing the air intake duct to the front body panel – later 1.9 litre models

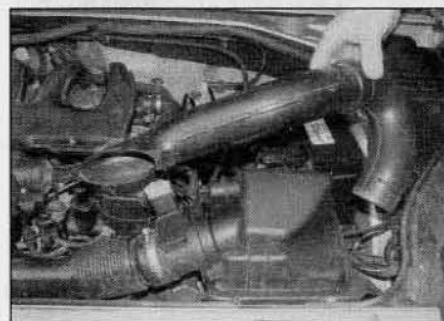

3.16 Withdraw the duct from the base of the air cleaner and remove it from the vehicle – later 1.9 litre models

duct to the airflow meter on the air cleaner lid, and to the EGR valve housing. Undo the mounting bolt at the base of the resonator, then disconnect the duct and remove it from the engine (see illustrations).

8 Disconnect the wiring connector from the airflow meter, mounted on the air cleaner lid (see illustration).

9 Undo the screw securing the air intake duct to the front body panel (see illustration). Slide the duct sideways slightly to disengage the additional retaining tab.

10 Undo the bolt securing the air cleaner upper mounting bracket to the body sidemember (see illustration).

11 Firmly apply the handbrake, then jack up the front of the car and support it securely on axle stands (see *Jacking and vehicle support*).

12 Remove the left-hand roadwheel and undo the screws securing the front of the wheel arch liner to the bumper and front wing.

13 Ease the wheel arch liner from its location, then undo the two air cleaner lower retaining nuts (see illustration). Lift the air cleaner and air intake duct upwards and out of the engine compartment. If necessary, slacken the retaining clip and separate the intake duct from the air cleaner housing.

#### WJY engine models – post-September 2002

14 Release the fasteners from the right-hand side and top of the engine cover then lift off the cover, taking care not to lose its mounting rubbers (see illustrations 3.1a to 3.1c).

15 Undo the nut securing the air intake duct to the front body panel (see illustration). Lift the duct off the mounting stud and slide it sideways slightly to disengage the additional retaining tab.

16 Withdraw the duct from the base of the air cleaner and remove it from the vehicle (see illustration).

17 Disconnect the wiring connector from the airflow meter, mounted on the side of the air cleaner lid (see illustration).

18 Slacken the retaining clip securing the inlet duct to the EGR valve housing and undo the mounting bolt at the base of the resonator.



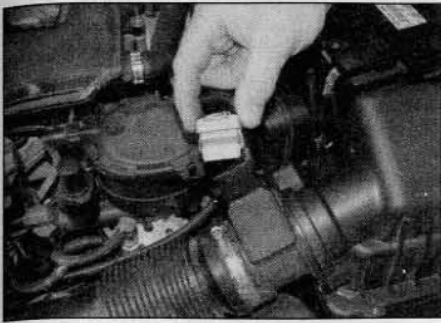

**3.17** Disconnect the wiring connector from the airflow meter – later 1.9 litre models

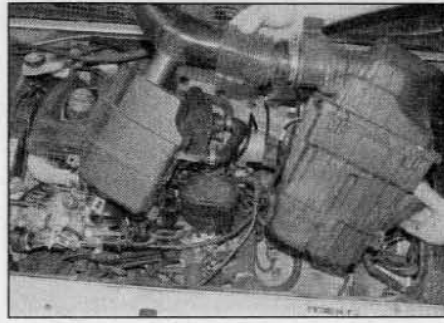

**3.19** Lift the duct and air cleaner housing out of the engine compartment as an assembly – later 1.9 litre models

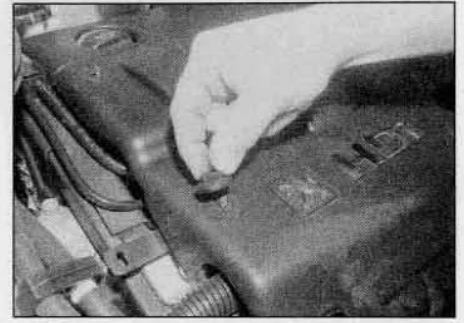

**3.20a** Rotate each fastener 90° to release it . . .

**19** Withdraw the duct from the EGR valve housing, and disengage the air cleaner housing from its mounting bracket. Lift the duct and air cleaner housing out of the engine compartment as an assembly (see illustration).

**Removal – 2.0 litre models**

**Pre-September 2002 models**

**20** Remove the fasteners (rotate them 90° to release them) and remove the engine cover (see illustrations).

**21** Slacken the retaining clips and free the flexible duct from the airflow meter and turbocharger rigid inlet duct (see illustration). Suitably plug or cover the turbocharger rigid

inlet duct, using clean rag to prevent any dirt or foreign material from entering.

**22** Unscrew the two bolts and free the accelerator pedal position sensor bracket from the side of the air cleaner housing.

**23** Disconnect the wiring connector from the airflow meter on the side of the air cleaner lid. Lift the air cleaner housing assembly off of its mounting bracket and remove it from the engine compartment (see illustrations).

**24** To remove the air intake duct, slacken the retaining clip and disconnect the duct from the intake sleeve on the front body panel. Undo the bolts securing the duct to the air cleaner mounting bracket and remove the duct from the engine compartment.

**25** The rigid ducts at the rear of the engine,

connecting the turbocharger to the flexible air inlet duct and to the inlet manifold, are inaccessible with the engine in the car. To gain access it will be necessary to either remove the engine/transmission unit as described in Chapter 2E, or remove the front suspension subframe as described in Chapter 10.

**26** Once access has been gained, begin removal of the turbocharger rigid inlet duct by disconnecting the crankcase ventilation hose at the top of the duct.

**27** Undo the bolt securing the duct to the inlet manifold elbow (see illustration).

**28** At the lower end, undo the bolt securing the duct to the turbocharger (see illustration). Lift off the duct and recover the seal from the lower end.

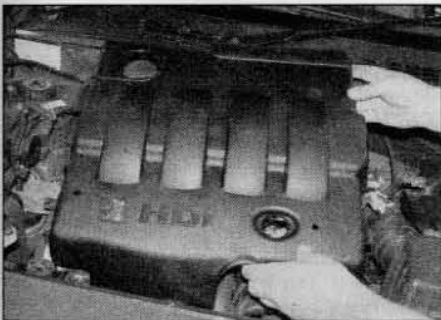

**3.20b** . . . then lift off the engine cover – 2.0 litre models

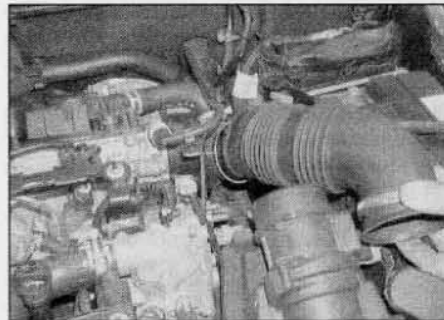

**3.21** Disconnect the flexible air inlet duct from the airflow meter and turbocharger rigid inlet duct – early 2.0 litre models

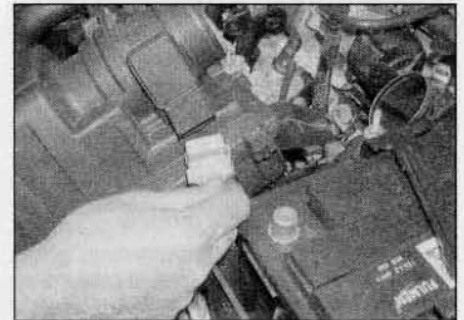

**3.23a** Disconnect the wiring connector from the airflow meter . . .

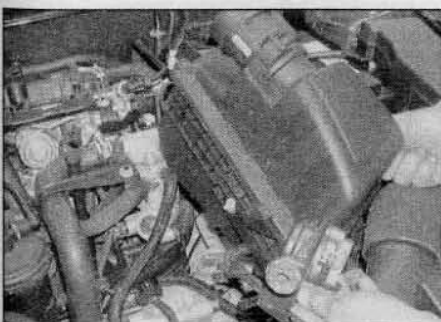

**3.23b** . . . then lift the air cleaner housing upward at the rear and disengage the front locating lugs – early 2.0 litre models



**3.27** Undo the upper mounting bolt (arrowed) securing the rigid inlet duct to the inlet manifold – early 2.0 litre models

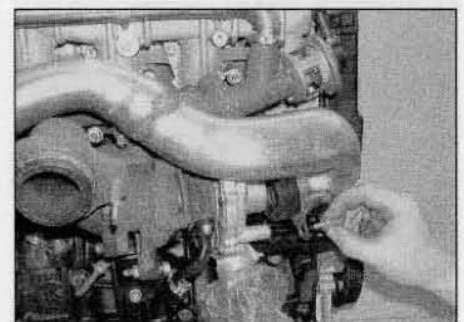

**3.28** Undo the bolt securing the rigid inlet duct to the turbocharger and remove the duct – early 2.0 litre models

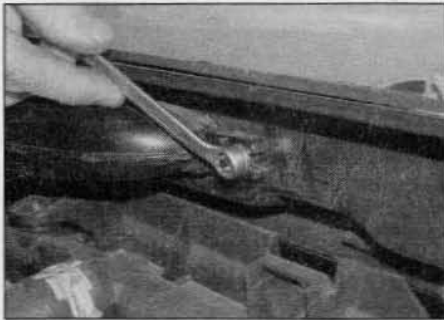

**3.32** Undo the nut securing the air intake duct to the front body panel – later 2.0 litre models



**3.33** Disconnect the wiring connector from the airflow meter – later 2.0 litre models



**3.34** Slacken the retaining clip and disconnect the flexible air inlet duct from the airflow meter – later 2.0 litre models

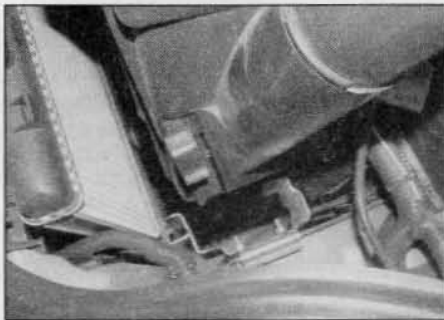

**3.35a** Disengage the air cleaner housing from its mounting bracket . . .



**3.35b** . . . then remove the air cleaner housing and intake duct as an assembly – later 2.0 litre models

**29** To remove the turbocharger-to-inlet manifold rigid plastic duct, slacken the retaining clip and release the connecting hose from the inlet manifold elbow.

**30** Slacken the clip securing the connecting hose at the lower end of the duct to the turbocharger. Release the attachment strap from the lug on the turbocharger and withdraw the duct from the engine.

**Post-September 2002 models**

**31** Remove the fasteners (rotate them 90° to release them) and remove the engine cover (see illustrations 3.20a and 3.20b).

**32** Undo the nut securing the air intake duct to the front body panel (see illustration). Lift the duct off the mounting stud and slide it

sideways slightly to disengage the additional retaining tab.

**33** Disconnect the wiring connector from the airflow meter at the rear of the air cleaner lid (see illustration).

**34** Slacken the retaining clip and disconnect the flexible air inlet duct from the airflow meter (see illustration).

**35** Disengage the air cleaner housing from its mounting bracket, then lift the air cleaner housing and air intake duct out of the engine compartment as an assembly (see illustrations).

**36** To remove the rigid ducts at the rear of the engine, proceed as described in paragraphs 25 to 30 above.

**Refitting**

**37** Refitting is a reversal of the removal procedure, ensuring that all hoses and ducts are properly reconnected and correctly seated and are securely held by their retaining clips/bolts.

**4 Accelerator cable – removal, refitting and adjustment**

**Removal**

**1.9 litre models**

**1** Remove the air inlet duct as described in Section 3. Free the accelerator inner cable from the injection pump accelerator lever, then pull the outer cable out from the mounting bracket, complete with its spring clip. Whilst the cable is disconnected, remove the cable locating collar from the mounting bracket for safe-keeping (see illustrations).

**2.0 litre models – pre-September 2002**

**2** Remove the fasteners (rotate them 90° to release them) and remove the engine cover (see illustrations 3.20a and 3.20b).

**3** Unscrew the two bolts and free the accelerator pedal position sensor bracket from the side of the air cleaner housing. Detach the accelerator inner cable from the sensor, then pull the outer cable out from



**4.1a** Free the accelerator inner cable from the lever . . .



**4.1b** . . . then withdraw the outer cable from the pump bracket, complete with spring clip – 1.9 litre models



**4.1c** Remove the cable locating collar from the pump whilst the cable is removed – 1.9 litre models



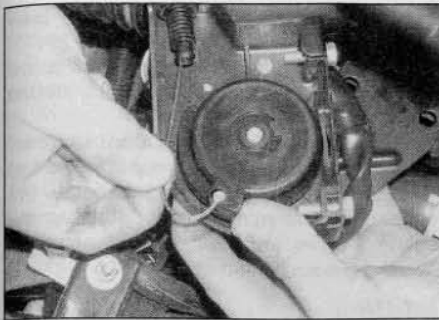

**4.3 Detach the accelerator inner cable from the pedal position sensor – early 2.0 litre models**

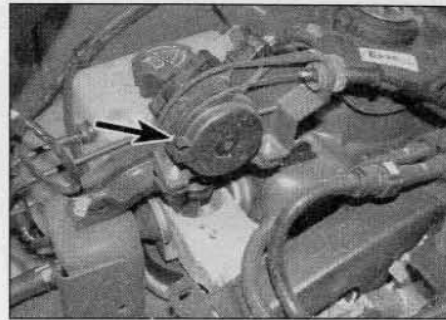

**4.4 Detach the accelerator inner cable from the pedal position sensor (arrowed) – later 2.0 litre models**

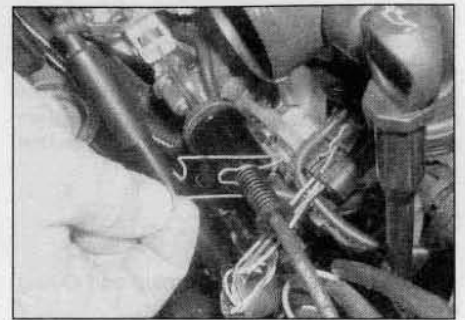

**4.15 Slide off the spring clip and adjust the accelerator cable as described in text – 1.9 litre model shown**

sensor bracket, complete with the spring clip (see illustration).

**2.0 litre models – post-September 2002**

4 Detach the accelerator inner cable from the pedal position sensor, located above the right-hand engine transmission mounting (see illustration).

5 Withdraw the outer cable from the rubber grommet on the sensor bracket, complete with the spring clip.

**All models**

6 Working back along the length of the cable, free it from any retaining clips or ties, noting its correct routing.

7 Working inside the car, remove the fusebox cover and the undercover from beneath the fascia on the driver's side.

8 Reach up under the fascia, depress the ends of the cable end fitting and detach the inner cable from the top of the accelerator pedal. Where fitted, pull out the clip securing the bulkhead grommet.

9 Tie a length of string to the end of the cable.

10 Return to the engine compartment, release the cable grommet from the bulkhead and withdraw the cable. When the end of the cable appears, untie the string and leave it in position – it can then be used to draw the cable back into position on refitting.

**Refitting**

11 Tie the string to the end of the cable, then use the string to draw the cable into position through the bulkhead. Once the cable end is visible, untie the string, then attach the inner cable to the pedal. Where applicable, refit the bulkhead grommet clip.

12 From within the engine compartment, ensure the outer cable is correctly seated in the bulkhead grommet, then work along the cable, securing it in position with the retaining clips and ties, and ensuring that the cable is correctly routed.

13 On 1.9 litre models, fit the locating collar to the mounting bracket then pass the cable through the collar and reconnect the inner cable to the accelerator lever. Adjust the cable as described below, then refit the fascia trim panels.

14 On 2.0 litre models, pass the outer cable

through the sensor bracket grommet and reconnect the inner cable to the accelerator pedal position sensor. Where applicable, refit the sensor bracket to the side of the air cleaner housing, tightening its retaining bolts securely. Adjust the cable as described below, then refit the fascia trim panels.

**Adjustment**

15 On all models, remove the spring clip from the accelerator outer cable (see illustration). Ensuring that the injection pump lever/accelerator pedal position sensor is fully against its stop, gently pull the cable out of its grommet until all free play is removed from the inner cable.

16 With the cable held in this position, refit the spring clip to the last exposed outer cable groove in front of the rubber grommet and washer. When the clip is refitted and the outer cable is released, there should be only a small amount of free play in the inner cable.

17 Have an assistant depress the accelerator pedal, and check that the accelerator lever/pedal position sensor opens fully and returns smoothly to its stop.

18 On completion, refit the engine cover, securing it in position with the fasteners.

**5 Accelerator pedal – removal and refitting**

**Removal**

1 Detach the accelerator cable from the pedal as described in Section 4.

**Right-hand drive models**

2 Unscrew the nut from the end of the pedal pivot shaft, whilst retaining the pivot shaft with an open-ended spanner on the flats provided.

3 Withdraw the pedal and pivot shaft assembly from the support bracket.

4 Examine the pivot shaft for signs of wear or damage and, if necessary, renew it. The pivot shaft is a screw fit in the pedal.

**Left-hand drive models**

5 Unscrew the two nuts and lift off the pedal pivot housing cover and upper bearing.

6 Withdraw the pedal from the lower bearing.

7 Examine the pivot bushes and shaft for signs of wear and renew as necessary.

**Refitting**

8 Refitting is a reversal of the removal procedure, applying a little multi-purpose grease to the pedal pivot point. On completion, adjust the accelerator cable as described in Section 4.

**6 Fuel system – priming and bleeding**

1 After disconnecting part of the fuel supply system or running out of fuel, it is necessary to prime the fuel system and bleed off any air which may have entered the system components, as follows.

**1.9 litre models**

2 All models are fitted with a hand-operated priming pump which is built into the fuel filter housing. To gain access to the pump, release the fasteners from the right-hand side and top of the engine cover then lift off the cover, taking care not to lose its mounting rubbers (see illustrations 3.1a to 3.1c).

3 Pump the priming pump until resistance is felt then pump a few more times (see illustration). This will prime the fuel system components and remove all air from the system.

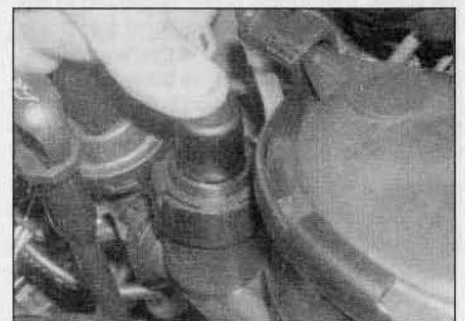

**6.3 Priming the fuel system – 1.9 litre models**



- 4 Start the engine as normal. If difficulty is encountered, pump the priming pump a few times with the ignition switched on.
- 5 Once the engine has started, ensure the mounting rubbers are all correctly fitted then install the engine cover, securing it in position with the fasteners.

**2.0 litre models**

**Bosch injection pump**

**Note:** A new fuel filter drain plug and O-ring will be required for this operation.

- 6 Remove the fasteners (rotate them 90° to release them) and remove the engine cover (see illustrations 3.20a and 3.20b).

7 On completion of work on the fuel system slacken, or leave loose (as appropriate), the new fuel filter drain plug. Operate the low pressure pump 4 or 5 times by switching on the ignition each time for a period of 5 seconds. Switch off the ignition and wait for a period of 5 to 10 seconds to allow the pressure to fall in the fuel supply circuit. Tighten the drain plug and wipe away all spilled fuel. Start the engine and check that there is no sign whatever of fuel seepage from the filter drain plug once the engine is running.

**Siemens injection pump**

- 8 Remove the fasteners (rotate them 90° to release them) and remove the engine cover (see illustrations 3.20a and 3.20b).

9 A hand-operated priming pump is located on the front right-hand side of the engine (see illustration).

10 Pump the priming pump until resistance is felt then pump a few more times. This will prime the fuel system components and remove all air from the system.

11 Start the engine as normal. If difficulty is encountered, pump the priming pump a few times with the ignition switched on.

12 Once the engine has started, refit the engine cover, securing it in position with the fasteners.

**7 Fuel supply pump (2.0 litre models) – removal and refitting**

1 On models with a Bosch injection pump, the diesel fuel supply pump is located in the same position as the conventional fuel pump on petrol engine models, and the removal and refitting procedures are virtually identical. Refer to Chapter 4A, Section 8.

2 A fuel supply pump is not fitted to models with a Siemens injection pump.

**8 Fuel gauge sender unit – removal and refitting**

1 The fuel gauge sender unit can be removed as described in Chapter 4A, Section 8. **Note:** On 1.9 litre models, and 2.0 litre models with a

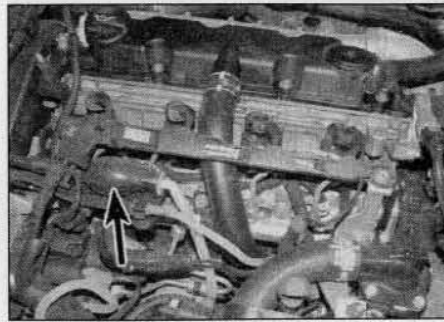

**6.9 Priming pump location (arrowed) on 2.0 litre models with Siemens injection pump**

*Siemens injection pump, the fuel gauge sender unit does not have the fuel pump as part of the assembly. On 2.0 litre models with a Bosch injection pump, the fuel gauge sender unit is an integral part of the fuel pump and is not available separately.*

2 On completion, bleed the fuel system as described in Section 6.

**9 Fuel tank – removal and refitting**

Refer to Chapter 4A, Section 10.

**10 Fast idle thermostatic sensor (1.9 litre models) – removal, refitting and adjustment**

**Removal**

**Note:** A new sealing washer must be used when refitting the sensor.

1 The thermostatic sensor is located in the side of the thermostat/fuel filter housing.

2 To gain access to the sensor, remove the relevant air intake duct(s) as described in Section 3.

3 Drain the cooling system as described in Chapter 1B.

4 Loosen the clamp screw or nut (as applicable), and disconnect the fast idle cable end fitting from the inner cable at the fuel



**10.4 Slacken the retaining screw (arrowed) then slide the end fitting off the fast idle cable – 1.9 litre models**

injection pump fast idle lever (see illustration).

5 Slide the cable from the adjustment screw located in the bracket on the fuel injection pump.

6 Using a suitable open-ended spanner, unscrew the thermostatic sensor from the fuel filter/thermostat housing, and withdraw the sensor complete with the cable. Recover the sealing washer and discard it; a new one should be used on refitting.

**Refitting**

7 Fit the sensor, complete with a new sealing washer, and tighten it securely.

8 Ensure the cable is correctly routed then pass it through the adjustment screw on the bracket.

9 Insert the inner cable through the fast idle lever, and position the end fitting on the cable, but do not tighten the clamp screw or nut (as applicable).

10 Adjust the cable as described in the following paragraphs.

**Adjustment**

11 If not already done, release the fasteners from the right-hand side and top of the engine cover then lift off the cover, taking care not to lose its mounting rubbers (see illustrations 3.1a to 3.1c).

12 With the engine cold, slacken the fast idle cable end fitting clamp screw/nut. Push the fast idle lever fully towards the flywheel end of the engine then remove all slack from the cable. With the fast idle lever against its stop and the end fitting firmly against the lever, securely tighten the clamp screw or nut.

13 Check the fast idle lever is firmly against its stop. If necessary, adjust the cable using the screw and locknut arrangement fitted to the injection pump bracket (see illustration).

14 Ensure the end fitting clamp screw/nut and adjuster locknut are securely tightened then measure the exposed length of the fast idle inner cable.

15 Refit the intake duct assembly (where removed – see Section 3).

16 Refill the cooling system as described in Chapter 1B, and run the engine to its normal operating temperature.

17 With the engine at its normal operating

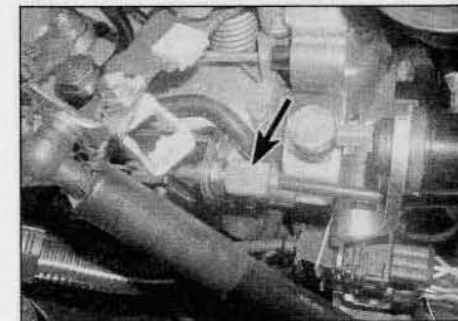

**10.13 Fast idle cable adjustment screw and locknut – 1.9 litre models**

temperature, the thermostatic sensor cable should be slack with approximately 0.5 to 1.0 mm of freeplay present. If no freeplay is present in the cable, it is likely that the sensor is faulty. If the thermostatic sensor is functioning correctly, the cable travel should be at least 6 mm from cold to hot.

**18** Check that the engine speed increases when the fast idle lever is pushed towards the flywheel end of the engine.

**19** If all is well, stop the engine and refit the relevant air intake ducts.

**20** Ensure the mounting rubbers are all correctly fitted then install the engine cover, securing it in position with the fasteners.

### 11 Fuel injection pump (1.9 litre models) – adjustment



**1** The usual type of tachometer (rev counter), which works from ignition system pulses, cannot be used on diesel engines. For the following adjustments to be accurately carried out, it will be necessary to purchase or hire an appropriate tachometer, or entrust the work to a Peugeot/Citroën dealer or other suitably-equipped specialist.

**2** Before making adjustments, warm-up the engine to normal operating temperature. Make sure that the accelerator cable and fast idle cable are correctly adjusted as described in Sections 4 and 10 respectively.

**3** Release the fasteners from the right-hand side and top of the engine cover then lift off the cover, taking care not to lose its mounting rubbers (see illustrations 3.1a to 3.1c).

#### Lucas fuel injection pump

**4** With the engine idling, place a shim of the correct thickness (see Specifications), between the pump control lever and the anti-stall adjustment screw (see illustration).

**5** Push the manual stop lever back against its stop, and hold it in position by inserting a 3.0 mm diameter rod/drill through the hole in the fast idle lever.

**6** The engine speed should be as specified for the anti-stall speed.

**7** If adjustment is necessary, loosen the locknut, turn the anti-stall adjustment screw as required, then tighten the locknut.

**8** Remove the rod/drill and the shim, and check that the engine is idling at the specified idle speed.

**9** If adjustment is necessary, loosen the locknut on the idle speed adjustment screw. Turn the screw as required, and retighten the locknut.

**10** Move the pump control lever to increase the engine speed to approximately 3000 rpm, then quickly release the lever. The deceleration period should be between 2.5 and 3.5 seconds, and the engine speed should drop to approximately 50 rpm below idle.

**11** If the deceleration is too fast and the engine stalls, unscrew the anti-stall

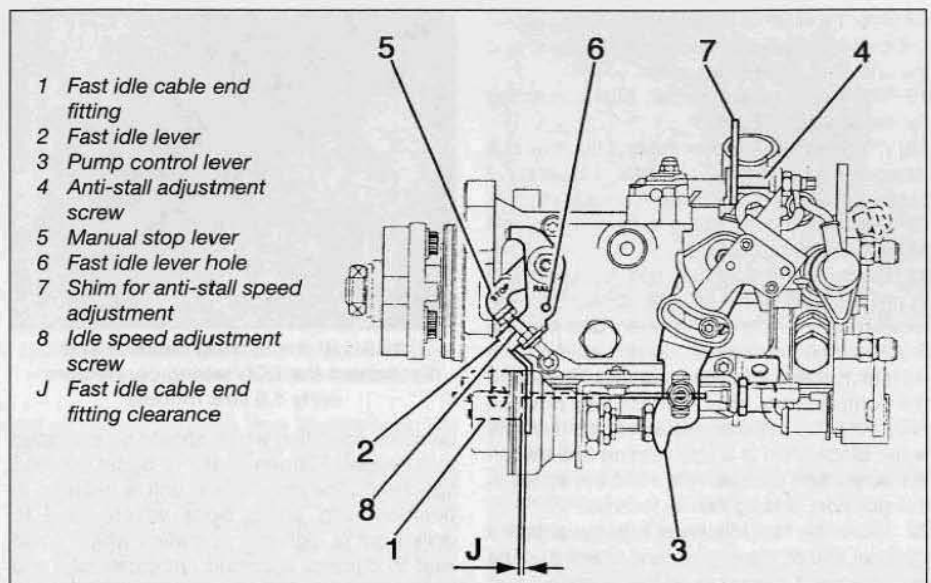

11.4 Lucas fuel injection pump adjustment points – 1.9 litre models

adjustment screw a quarter-turn towards the control lever. If the deceleration is too slow, resulting in poor engine braking, turn the screw a quarter-turn away from the lever.

**12** Retighten the locknut after making an adjustment. Recheck the idle speed, and adjust if necessary as described previously.

**13** With the engine idling, check the operation of the manual stop control by turning the stop lever clockwise (see illustration 11.4). The engine must stop instantly.

**14** Disconnect the tachometer on completion and refit the engine cover.

#### Bosch fuel injection pump

**15** Loosen the locknut, and unscrew the anti-stall adjustment screw until it is clear of the pump control lever (see illustration).

**16** Start the engine and allow it to idle. If the idle speed is incorrect, loosen the locknut and turn the idle speed adjustment screw as required, then retighten the locknut.

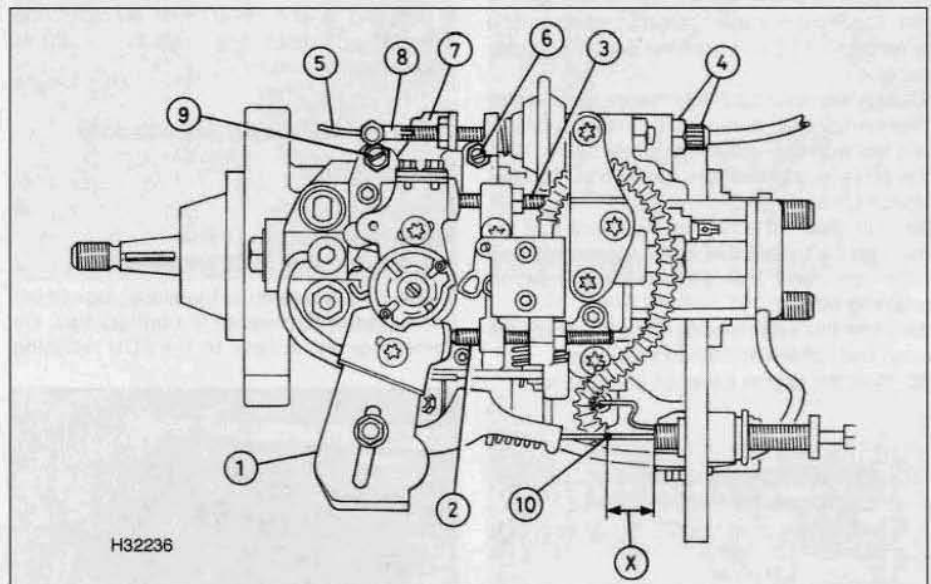

11.15 Bosch fuel injection pump adjustment points – 1.9 litre models

- 1 Pump control lever
- 2 Maximum speed adjustment screw
- 3 Anti-stall adjustment screw
- 4 Fast idle cable adjustment screw and locknut

- 5 Fast idle cable
- 6 Idle speed adjustment screw
- 7 Fast idle lever
- 8 Fast idle cable end fitting
- 9 Fast idle adjustment screw

- 10 Mark to be made on accelerator cable for throttle position switch adjustment
- X = 11.0 mm



17 Insert a shim or feeler blade of the correct thickness between the pump control lever and the anti-stall adjustment screw.

18 The engine speed should be as specified for the anti-stall speed.

19 If adjustment is necessary, loosen the locknut and turn the anti-stall adjustment screw as required. Retighten the locknut.

20 Remove the shim or feeler blade and allow the engine to idle.

21 Slacken the locknut and unscrew the control lever damper adjustment screw, located on the rear of the lever, and insert a 2.0 mm shim or feeler blade between the damper rod and adjustment screw. Make sure the pump control lever is in the idle position then turn the adjustment screw so that the feeler blade/shim is a light, sliding fit between the screw and damper rod. Hold the screw in this position, and tighten its locknut.

22 Move the fast idle lever fully towards the flywheel end of the engine, and check that the engine speed increases to the specified fast idle speed. If necessary, loosen the locknut and turn the fast idle adjusting screw as required, then retighten the locknut.

23 With the engine idling, check the operation of the manual stop control by turning the stop lever. The engine must stop instantly.

24 Disconnect the tachometer on completion.

25 With all the previously described adjustments completed, check the adjustment of the throttle position switch located on the pump control lever as follows.

26 Working at the fuel injection pump end of the accelerator cable, make a mark on the inner cable, 11.0 mm from the end of the outer cable.

27 Have an assistant depress the accelerator pedal until the mark on the inner cable is aligned with the end of the outer cable. With the cable in this position, the throttle position switch contacts should just open.

28 If adjustment is necessary, check that the mark on the inner cable is still aligned with the outer cable end, then slacken the two switch retaining screws.

29 Turn the switch body until the contacts open and tighten the retaining screws.

30 Refit the engine cover on completion.

**12 Injection system electrical components – removal and refitting**

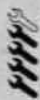

**1.9 litre WJZ engine models**

**Stop solenoid**

1 The stop solenoid is part of the immobiliser unit which is located on the top of the fuel injection pump, its purpose being to cut the fuel supply when the ignition is switched off. Renewal of the immobiliser/solenoid unit is a

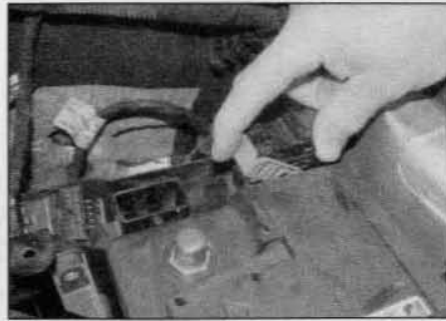

**12.8 Lift the locking catches and disconnect the ECU wiring connectors – early 1.9 litre models**

complex operation which should be entrusted to a Peugeot/Citroën dealer or diesel injection specialist. The immobiliser unit is secured in position with shear bolts which have to be drilled out (a high-risk operation which could lead to damage if carried out carelessly) and the new unit will have to be initialised on refitting.

**Fuel cut-off inertia switch**

**Note:** A fuel cut-off inertia switch is not fitted to all models.

2 The fuel cut-off inertia switch is located in the right-hand rear corner of the engine compartment. To remove it, first disconnect the battery negative terminal (refer to *Disconnecting the battery* in the Reference Chapter).

3 Unscrew the retaining bolts then disconnect the wiring connector and remove the switch from the vehicle.

4 Refitting is the reverse of removal. On completion, reset the switch by firmly depressing its button.

**1.9 litre WJY engine models**

**Stop solenoid**

5 See paragraph 1.

**Electronic control unit – pre-September 2002 models**

6 The ECU is located in the plastic box which forms part of the rear of the battery tray. On some engines, access to the ECU retaining

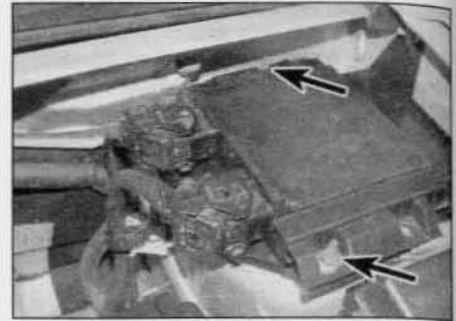

**12.14a Undo the retaining nuts (arrowed) . . .**

nuts/bolts is poor and it is beneficial to remove the battery mounting tray as described in Chapter 5A, then remove the ECU with the tray on the bench.

7 Disconnect the battery negative terminal (refer to *Disconnecting the battery* in the Reference Chapter).

8 Where fitted, lift up the cover over the ECU, then lift the locking catches and disconnect the ECU wiring connectors (see illustration).

9 Undo the retaining nuts or bolts and lift the ECU mounting plate from the battery tray.

10 Undo the retaining nuts or bolts and separate the ECU from the mounting plate.

11 Refitting is a reverse of the removal procedure ensuring the wiring connectors are securely reconnected.

**Electronic control unit – post-September 2002 models**

12 The ECU is located at the rear left-hand corner of the engine compartment, above the suspension strut upper mounting.

13 Disconnect the battery negative terminal (refer to *Disconnecting the battery* in the Reference Chapter).

14 Undo the retaining nuts and lift off the ECU cover, where fitted (see illustrations).

15 Lift the ECU up and off the mounting bracket, then lift the locking catches and disconnect the wiring connectors (see illustration).

16 If required, the mounting bracket can be



**12.14b . . . and lift off the ECU cover – later 1.9 litre models**



**12.15 Lift the ECU off the mounting bracket, then disconnect the wiring connectors – later 1.9 litre models**



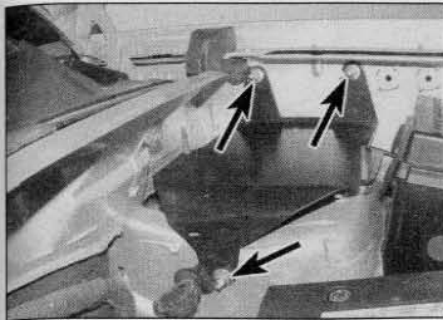

**12.16 ECU mounting bracket retaining bolts (arrowed) – later 1.9 litre models**

removed after undoing the three retaining nuts (see illustration).

**17** Refitting is a reverse of the removal procedure ensuring the wiring connectors are securely reconnected.

**Airflow meter – pre-September 2002 models**

**18** Disconnect the battery negative terminal (refer to *Disconnecting the battery* in the Reference Chapter).

**19** Slacken the retaining clip securing the air inlet duct to the airflow meter on the air cleaner lid. Detach the duct from the airflow meter.

**20** Disconnect the airflow meter wiring connector (see illustration).

**21** Slacken the retaining clip securing the airflow meter to the air cleaner lid and lift off the meter (see illustration).

**22** Refitting is a reverse of the removal procedure ensuring the wiring connector is securely reconnected.

**Airflow meter – post-September 2002 models**

**23** Disconnect the battery negative terminal (refer to *Disconnecting the battery* in the Reference Chapter).

**24** Slacken the retaining clip securing the air inlet duct to the airflow meter on the air cleaner lid.

**25** Disconnect the airflow meter wiring connector (see illustration).

**26** Undo the four screws securing the lid to

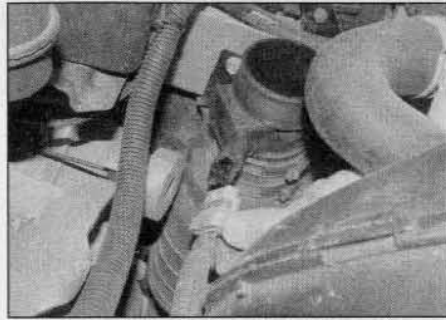

**12.20 Disconnect the airflow meter wiring connector – early 1.9 litre models**

the air cleaner housing (see illustration). Lift off the lid and detach the air inlet duct.

**27** Undo the two screws securing the airflow meter to the air cleaner lid and withdraw the meter from the lid (see illustration).

**28** Refitting is a reverse of the removal procedure ensuring the wiring connector is securely reconnected.

**Crankshaft sensor**

**29** The crankshaft sensor is situated on the top of the transmission unit.

**30** To remove the sensor, first disconnect the battery negative terminal (refer to *Disconnecting the battery* in the Reference Chapter).

**31** Disconnect the wiring connector from the sensor then slacken the mounting bolt and remove the sensor from the transmission unit



**12.25 Disconnect the airflow meter wiring connector – later 1.9 litre models**



**12.21 Slacken the retaining clip and lift off the airflow meter – early 1.9 litre models**

(the sensor is slotted to ease removal) (see illustrations).

**32** Refitting is reverse of the removal procedure.

**Vehicle speed sensor**

**33** The vehicle speed sensor is an integral part of the speedometer drive. Refer to Chapter 7 for removal and refitting details.

**Injector needle lift sensor**

**34** The needle lift sensor is an integral part of No 1 cylinder injector. See Section 15 for removal and refitting details.

**Coolant temperature sensor**

**35** The coolant temperature sensor is screwed into the thermostat/fuel filter housing. Refer to Chapter 3 for removal and refitting information.

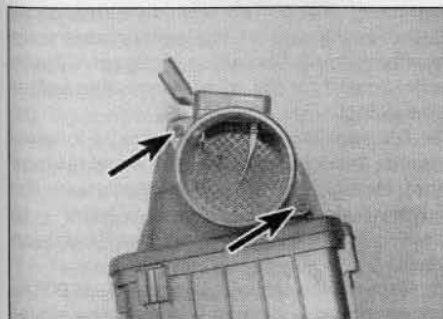

**12.27 Undo the two screws (arrowed) and withdraw the airflow meter from the air cleaner lid – later 1.9 litre models**



**12.31a Slacken the mounting bolt ...**

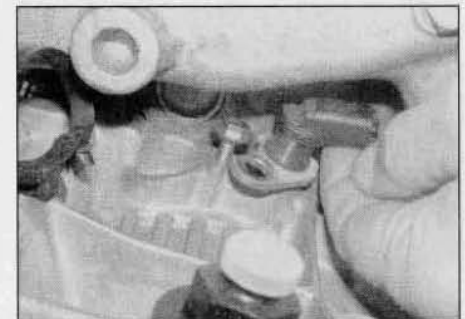

**12.31b ... then free the crankshaft sensor from the bolt and manoeuvre it out of position**

**12.26 Undo the four screws (arrowed) securing the lid to the air cleaner housing – later 1.9 litre models**



12.43 Disconnect the wiring connector from the airflow meter – 2.0 litre models



12.45a Undo the air cleaner lid retaining screws ...



12.45b ... disengage the two retaining lugs and lift the lid from the air cleaner housing – 2.0 litre models

### Throttle potentiometer and advance solenoid

36 These components are both fitted to the injection pump. If either of the above are faulty, renewal should be entrusted to a Peugeot/Citroën dealer who will have the necessary special equipment to adjust and calibrate the components.

### Fuel cut-off inertia switch

**Note:** A fuel cut-off inertia switch is not fitted to all models.

37 Proceed as described in paragraphs 2 to 4.

### 2.0 litre models

#### Electronic control unit

38 Proceed as described in paragraphs 6 to 17.

#### Crankshaft sensor

39 Proceed as described in paragraphs 29 to 32. Access to the sensor is poor; remove the battery and battery tray to improve access (see Chapter 5A)

#### Vehicle speed sensor

40 The vehicle speed sensor is an integral part of the speedometer drive. Refer to Chapter 7 for removal and refitting details.

#### Coolant temperature sensor

41 The coolant temperature sensor is fitted to the side of the coolant outlet/thermostat housing on the left-hand end of the cylinder head. Refer to Chapter 3 for removal and refitting information.

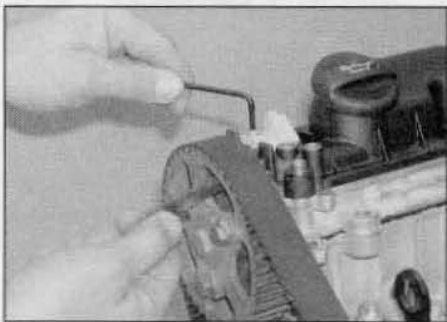

12.55 Adjust the camshaft sensor air gap as described in the text – 2.0 litre models

### Airflow meter

42 Disconnect the battery negative terminal (refer to *Disconnecting the battery* in the Reference Chapter).

43 Disconnect the wiring connector from the airflow meter, located on the air cleaner lid (see illustration).

44 Slacken the retaining clip and disconnect the air inlet duct from the airflow meter.

45 Undo the two screws securing the lid to the air cleaner housing. Lift up the right-hand side of the lid and disengage the two left-hand retaining lugs from the air cleaner housing (see illustrations).

46 Undo the two screws securing the airflow meter to the air cleaner lid and withdraw the meter from the lid.

47 Refitting is a reverse of the removal procedure ensuring the wiring connector is securely reconnected.

### Camshaft position sensor

48 The camshaft position sensor is fitted to the top of the cylinder head cover right-hand end. Prior to removal, disconnect the battery negative terminal (refer to *Disconnecting the battery* in the Reference Chapter). Remove the fasteners (rotate them 90° to release them) and remove the engine cover (see illustrations 3.20a and 3.20b).

49 Remove the timing belt upper cover (see Chapter 2C).

50 Disconnect the camshaft sensor wiring connector.

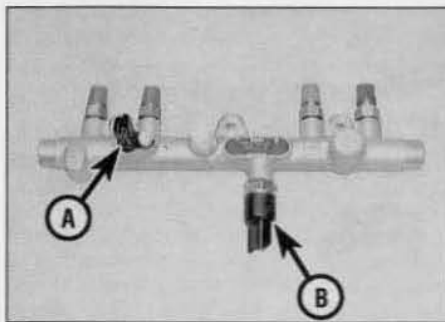

12.58 Fuel temperature sensor (A) and fuel pressure sensor (B) locations on the fuel rail (shown removed for clarity) – 2.0 litre models

51 Unscrew the retaining bolt and remove the sensor from the engine.

52 On refitting, align the camshaft hub timing hole with the cylinder head hole (see Chapter 2C, Section 3). Insert the flywheel locking tool to ensure the camshaft is correctly positioned.

53 Fit the sensor to its mounting bracket and lightly tighten its bolt.

54 If a new sensor is being fitted, position the sensor so its fitting lug is in contact with the rear of the camshaft hub then securely tighten the sensor bolt. The lug automatically sets the sensor air gap to the correct distance and will be knocked off the first time the engine is started.

55 If the original sensor is being refitted, using feeler gauges, set the gap between the sensor tip and camshaft hub to 1.2 mm. Ensure the sensor is correctly positioned then securely tighten its retaining bolt (see illustration). Check the air gap and, if necessary, readjust.

56 Once the sensor is correctly positioned, refit the timing belt cover and remove the flywheel locking tool (where fitted).

57 Reconnect the sensor wiring connector and battery negative terminal, then refit the engine cover.

### Fuel temperature sensor

**Warning:** Refer to the precautionary information contained in Section 2 before proceeding.

**Note:** Do not remove the sensor from the fuel rail unless there is a valid reason to do so. At the time of writing there was no information as to the availability of the sensor seal as a separate item. Consult a Peugeot/Citroën parts stockist for the latest information before proceeding.

58 The fuel temperature sensor is located towards the right-hand end of the fuel rail (see illustration). Prior to removal, disconnect the battery negative terminal (refer to *Disconnecting the battery* in the Reference Chapter).

59 Remove the fasteners (rotate them 90° to release them) and remove the engine cover (see illustrations 3.20a and 3.20b).

60 Disconnect the fuel temperature sensor wiring connector.



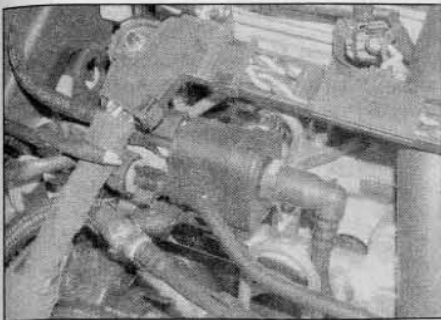

12.85 Fuel heater assembly – 2.0 litre models

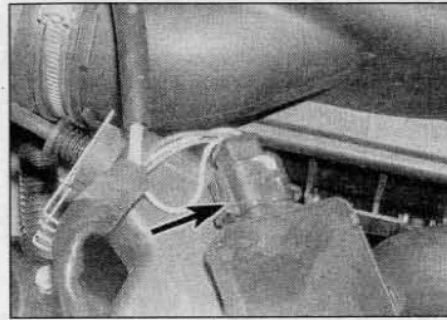

12.93 Disconnect the wiring connector (arrowed) . . .

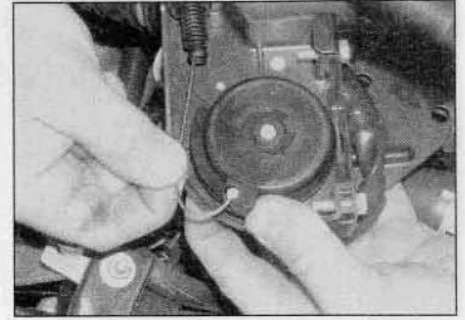

12.94 . . . then detach the cable and remove the accelerator pedal position sensor from the vehicle – early 2.0 litre models

61 Thoroughly clean the area around the sensor and its location on the fuel rail.

62 Suitably protect the components below the sensor and have plenty of clean rags handy. Be prepared for considerable fuel spillage.

63 Undo the retaining bolt and withdraw the sensor from the fuel rail. Plug the opening in the fuel rail as soon as the sensor is withdrawn.

64 Prior to refitting, if the original sensor is to be refitted, renew the sensor seal, where applicable (see the note at the start of this sub-Section).

65 Locate the sensor in the fuel rail and refit the retaining bolt, tightened securely.

66 Refit the sensor wiring connector and reconnect the battery.

67 Observing the precautions listed in Section 2, prime the fuel system as described in Section 6, then start the engine and allow it to idle. Check for leaks at the fuel temperature sensor with the engine idling. If satisfactory, increase the engine speed to 4000 rpm and check again for leaks. Take the car for a short road test and check for leaks once again on return. If any leaks are detected, obtain and fit a new sensor.

68 Refit the engine cover on completion.

#### Fuel pressure sensor



**Warning:** Refer to the precautionary information contained in Section 2 before proceeding.

**Note:** A 27 mm forked adaptor and a new sensor sealing ring will be required for this operation.

69 The fuel pressure sensor is located centrally on the underside of the fuel rail (see illustration 12.58).

70 Disconnect the battery negative terminal (refer to *Disconnecting the battery* in the Reference Chapter), then release the fasteners (rotate them 90° to release them) and remove the engine cover (see illustrations 3.20a and 3.20b).

71 Release the retaining clip and disconnect the crankcase ventilation hose from the cylinder head cover.

72 Disconnect the fuel supply and return hose quick-release fittings at the fuel filter, using a small screwdriver to release the

locking clip. Suitably plug or cover the open unions to prevent dirt entry. Release the fuel hoses from the relevant retaining clips.

73 Disconnect the fuel pressure sensor wiring connector.

74 Thoroughly clean the area around the sensor and its location on the fuel rail.

75 Suitably protect the components below the sensor and have plenty of clean rags handy. Be prepared for considerable fuel spillage.

76 Using the 27 mm forked adaptor and a socket bar, unscrew the fuel pressure sensor from the base of the fuel rail.

77 Obtain and fit a new sealing ring to the sensor prior to refitting.

78 Locate the sensor in the fuel rail and tighten it to the specified torque.

79 Reconnect the sensor wiring connector, fuel hoses, crankcase ventilation hose and battery.

80 Observing the precautions listed in Section 2, prime the fuel system as described in Section 6, then start the engine and allow it to idle. Check for leaks at the fuel pressure sensor with the engine idling. If satisfactory, increase the engine speed to 4000 rpm and check again for leaks. Take the car for a short road test and check for leaks once again on return. If any leaks are detected, obtain and fit another new sensor sealing ring.

81 Refit the engine cover on completion.

#### Third piston deactivator solenoid valve

82 The solenoid valve is mounted on the top of the injection pump; it is an integral part of the pump and cannot be renewed. If the valve is faulty the injection pump will have to be renewed or repaired. Never attempt to remove the solenoid from the pump.

#### High-pressure fuel regulator

83 The high-pressure fuel regulator is mounted on the rear of the injection pump; it is an integral part of the pump and cannot be renewed. If the regulator is faulty the injection pump will have to be renewed or repaired. Never attempt to remove the regulator from the pump.

#### Fuel cut-off inertia switch

84 Refer to paragraphs 2 to 4.

#### Electrically-operated fuel heater



**Warning:** Refer to the precautionary information contained in Section 2 before proceeding.

85 The fuel heater is fitted to the fuel feed pipe to the filter housing (see illustration).

86 Disconnect the battery negative terminal (refer to *Disconnecting the battery* in the Reference Chapter), then release the fasteners (rotate them 90° to release them) and remove the engine cover (see illustrations 3.20a and 3.20b).

87 Disconnect the wiring connector from the heater.

88 Remove all traces of dirt from around the heater; the heater and its surrounding area must be clean and dry before proceeding. Position a wad of rag beneath the heater to catch any spilt fuel.

89 Release the clips and disconnect the fuel pipes from the heater. Plug the fuel pipes to prevent the entry of dirt into the fuel system.

90 Unscrew the retaining bolt and remove the fuel heater from the engine.

91 Refitting is the reverse of removal. On completion, prime the fuel system as described in Section 5.

#### Accelerator pedal position sensor – pre-September 2002 models

92 Working in the engine compartment, unscrew the two bolts and free the accelerator pedal position sensor bracket from the side of the air cleaner housing.

93 Disconnect the sensor wiring connector (see illustration).

94 Free the accelerator inner cable from the sensor cam then free the outer cable from sensor bracket, complete with the spring clip, and remove the sensor from the vehicle (see illustration).

95 Refitting is the reverse of removal, adjusting the accelerator cable as described in Section 4.

#### Accelerator pedal position sensor – post-September 2002 models

96 The accelerator pedal position sensor is located above the right-hand engine/transmission mounting.

97 Disconnect the battery negative terminal





**12.97** Disconnect the wiring connector (arrowed) from the accelerator pedal position sensor – later 2.0 litre models

(refer to *Disconnecting the battery* in the Reference Chapter), then disconnect the wiring connector from the pedal position sensor (see illustration).

**98** Free the accelerator inner cable from the sensor cam, then pull the outer cable out from its mounting bracket rubber grommet, complete with spring clip.

**99** Undo the two mounting bracket retaining bolts and withdraw the pedal position sensor and mounting bracket from the engine compartment.

**100** Undo the two nuts and bolts securing the sensor to the mounting bracket and separate the two components.

**101** Refitting is a reversal of the removal procedure. On completion, adjust the accelerator cable as described in Section 4.

### 13 Fuel injection pump – removal and refitting



**Caution:** Be careful not to allow dirt into the injection pump or injector pipes during this procedure.

#### 1.9 litre models

**Note:** If the injection pump is being taken to a injection specialist for repair, unlock the immobiliser module as follows before disconnecting the battery. Switch on the ignition and lower the driver's door window. Get out of the vehicle and close all the doors

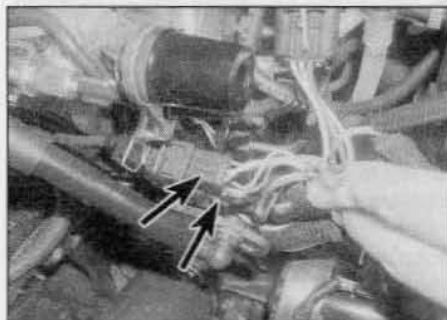

**13.11** Disconnect the wiring connectors (arrowed) from the rear of the injection pump – later 1.9 litre models

then switch off the ignition. Reach in through the window and switch on the ignition again, wait at least ten seconds then switch the ignition off. Immediately disconnect the battery negative terminal (refer to 'Disconnecting the battery' in the Reference Chapter) then disconnect the wiring connectors from the injection pump (the pump must be disconnected within ten minutes of the ignition being switched off). If the immobiliser module is not unlocked it will not be possible for the pump repairers to test the pump.

#### Removal

**1** Disconnect the battery negative terminal (refer to *Disconnecting the battery* in the Reference Chapter).

**2** Release the fasteners from the right-hand side and top of the engine cover then lift off the cover, taking care not to lose its mounting rubbers (see illustrations 3.1a to 3.1c).

**3** Remove the inlet duct connecting the air cleaner to the EGR valve housing (see Section 3).

**4** Cover the components beneath the injection pump with a plastic bag, as a precaution against fuel spillage.

**5** Remove the injection pump sprocket as described in Chapter 2C, Section 9.

**6** Remove the upper section of the inlet manifold (see Section 17).

**7** Disconnect the accelerator cable from the fuel injection pump (see Section 4).

**8** Disconnect the fast idle cable from the fuel injection pump (see Section 10).

**9** Trace the injection pump fuel feed pipe back to the filter. Wipe clean the pipe end fitting then release and disconnect the pipe from the filter. Plug the pipe end and filter housing union to minimise fuel loss and prevent the entry of dirt into the system.

**10** Wipe clean the area around the injection pump fuel return metal pipe unions. Disconnect the return pipe and hose from the metal pipe and plug the pipe and union ends to minimise fuel loss and prevent the entry of dirt into the system.

**11** Disconnect the wiring connectors from the injection pump (see illustration).

**12** Remove all traces of dirt from all the injector pipe unions. Unscrew the union nuts securing the injector pipes to the fuel injection pump and injectors. Counterhold the adaptors on the pump, while unscrewing the pipe-to-pump union nuts. Remove the pipes as a set. Plug the injection pump/injector unions to prevent the entry of dirt.

**13** Slacken the pump rear mounting bolt.

**14** Unscrew the three front mounting bolts securing the pump to the mounting bracket then manoeuvre the pump out of position.

**15** If necessary, unbolt the pump mounting bracket and remove it from the cylinder head, taking care not to lose its locating dowels.

#### Refitting

**16** If necessary, ensure the locating dowels are in position, then refit the mounting bracket

to the cylinder head. Tighten the bracket bolts to the specified torque.

**17** Ensure the pump rear mounting bolt, spacer, washer and nut are correctly fitted to the mounting bracket.

**18** Manoeuvre the pump into position and seat it correctly in the mounting bracket.

**19** Refit the pump front mounting bolts, tightening them to the specified torque. Once the front mounting bolts have been tightened, tighten the rear mounting bolt to the specified torque.

**20** Refit and reconnect the injector fuel pipes. Loosely tighten all the union nuts to ensure all pipes are correctly seated then go around and tighten them to the specified torque. Counterhold the injection pump adaptors whilst tightening the injection pump end nuts.

**21** Reconnect all relevant wiring to the pump.

**22** Securely reconnect the feed and return pipes to the injection pump and fuel filter housing.

**23** Reconnect and adjust the accelerator cable as described in Section 4.

**24** Reconnect and adjust the fast idle cable as described in Section 10.

**25** Refit the injection pump sprocket and timing belt as described in Chapter 2C.

**26** Refit the inlet manifold as described in Section 17.

**27** Prime the fuel system as described in Section 6. Start the engine and check for signs of fuel leaks before refitting the engine cover.

#### 2.0 litre models

**Note:** A new fuel pump-to-fuel rail high pressure fuel pipe will be required for refitting.

#### Removal

**28** Disconnect the battery negative terminal (refer to *Disconnecting the battery* in the Reference Chapter).

**29** Remove the injection pump sprocket as described in Chapter 2C, Section 9.

**30** At the connections above the fuel pump, disconnect the fuel supply and return hose quick-release fittings using a small screwdriver to release the locking clip. Suitably plug or cover the open unions to prevent dirt entry.

**31** Similarly disconnect the supply and return hose quick-release fittings at the fuel filter and plug or cover the open unions. Release the fuel hoses (and, on later models, the priming pump) from the relevant retaining clips.

**32** Lift the fuel filter out of its mounting bracket and move it slightly to one side, away from the pump.

**33** Undo the bolts and remove the filter mounting bracket from the engine.

**34** Undo the bolts securing the plastic wiring harness guide to the front of the engine. It will be necessary to lift up the wiring harness as far as possible for access to the rear of the fuel pump. If necessary, disconnect the relevant wiring connectors to enable the harness and guide assembly to be moved further for additional access.

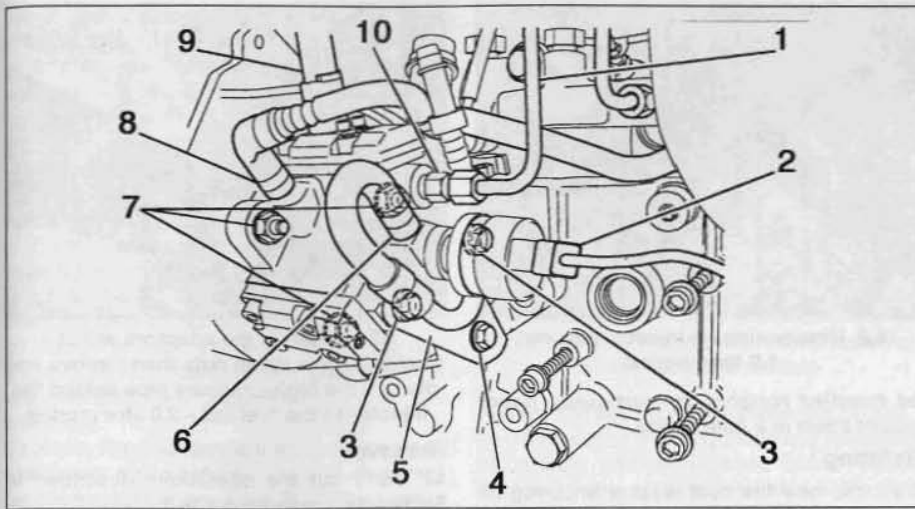
**13.36 Injection pump details – 2.0 litre models**

- |   |   |  |
|---|---|--|
| 1 High-pressure pipe                            | 4 Rear bracket-to-mounting bracket bolt | 8 Fuel feed hose   |
| 2 High-pressure fuel regulator wiring connector | 5 Rear bracket                          | 9 Third piston deactivator solenoid valve wiring connector |
| 3 Rear bracket-to-pump bolts                    | 6 Fuel return hose                      | 10 Fuel pipe adaptor                                       |
|   | 7 Pump front mounting nut/bolts         |  |

**35** Disconnect the wiring connector at the pressure control valve on the rear of the fuel pump, and at the piston de-activator switch on the top of the pump.

**36** Thoroughly clean the high pressure fuel pipe unions on the fuel pump and fuel rail. Using an open-ended spanner, unscrew the union nuts securing the high pressure fuel pipe to the fuel pump and fuel rail. Counterhold the unions on the pump and fuel rail with a second spanner, while unscrewing the union nuts. Withdraw the high pressure fuel pipe and plug or cover the open unions to prevent dirt entry (see illustration). Note that a new high pressure fuel pipe will be required for refitting.

**37** Undo the nut and bolt securing the fuel pump rear mounting to the mounting bracket.  
**38** Undo the nut and two bolts securing the front of the fuel pump to the mounting bracket. Withdraw the pump, complete with fuel supply and return hoses, rearwards, and lift it off the engine.

**Caution:** The high pressure fuel pump is manufactured to extremely close tolerances and must not be dismantled in any way. Do not unscrew the fuel pipe male union on the rear of the pump, or attempt to remove the pressure control valve, piston de-activator switch, or the seal on the pump shaft. No parts for the pump are available separately and if the unit is in any way suspect, it must be renewed.

#### Refitting

**39** Locate the pump on the mounting bracket, and refit the front retaining nut and the two bolts. Refit the nut and bolt securing

the fuel pump rear mounting to the mounting bracket, then tighten all the mountings to the specified torque.

**40** Remove the blanking plugs from the fuel pipe unions on the pump and fuel rail. Locate a new high pressure fuel pipe over the unions and screw on the union nuts finger tight at this stage.

**41** Using a torque wrench and crow-foot adaptor, tighten the fuel pipe union nuts to the specified torque. Counterhold the unions on the pump and fuel rail with an open-ended spanner, while tightening the union nuts (see illustration).

**42** Reconnect the wiring connector at the pressure control valve on the rear of the fuel pump.

**43** Reposition and secure the plastic wiring harness guide to the front of the engine, and reconnect any additional wiring disconnected for access.

**44** Refit the filter mounting bracket to the engine and securely tighten the retaining bolts. Locate the fuel filter back in position in the mounting bracket.

**45** Remove the blanking plugs and reconnect the supply and return hose quick-release fittings at the fuel filter, and at the connections above the fuel pump. Secure the hoses with their respective retaining clips.

**46** Refit the injection pump sprocket and timing belt as described in Chapter 2C.

**47** Observing the precautions listed in Section 2, prime the fuel system as described in Section 6, then start the engine and allow it to idle. Check for leaks at the high pressure fuel pipe unions with the engine idling. If satisfactory, increase the engine speed to 4000 rpm and check again for leaks. Take the

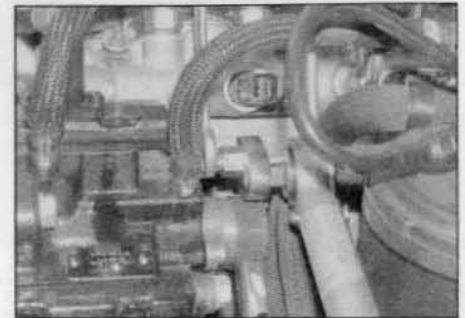

**13.41** When refitting the new high-pressure pipe to the pump and fuel rail, counterhold their adapters to tighten the union nuts to the specified torque – 2.0 litre models

car for a short road test and check for leaks once again on return. If any leaks are detected, obtain and fit another new high pressure fuel pipe. Do not attempt to cure even the slightest leak by further tightening of the pipe unions.

**48** Refit the engine cover on completion.

## 14 Injection timing – checking and adjustment

### 1.9 litre models

**1** The injection timing is set when the timing belt is installed. If at any time a fault is suspected, referring to Chapter 2C, Section 3, remove the timing belt covers and check that the flywheel, camshaft and injection pump timing holes are all correctly aligned so the locking tools can be inserted. If the timing holes are correctly aligned, the injection pump timing is correct (Peugeot/Citroën do not specify any static or dynamic timing figures for this engine – on the WJY engine the timing is being constantly altered by the ECU anyway). If not, remove and refit the timing belt as described in Chapter 2C.

### 2.0 litre models

**2** On the 2.0 litre engine the injection timing is determined by the ECU using the information from its various sensors. Checking and adjustment can only be carried out using specialist diagnostic equipment (see Section 1).

## 15 Fuel injectors – removal and refitting



**Warning:** Exercise extreme caution when working on the fuel injectors. Never expose the hands or any part of the body to injector spray, as the high working pressure can cause the fuel to penetrate the skin, with



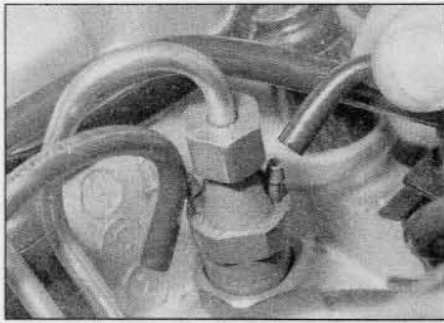

15.2 Disconnecting the leak-off pipe from the injector – 1.9 litre models

possibly fatal results. You are strongly advised to have any work which involves testing the injectors under pressure carried out by a dealer or fuel injection specialist.

### 1.9 litre models

**Caution:** Be careful not to allow dirt into the injection pump or injectors during this procedure.

#### Removal

- 1 Remove the upper section of the inlet manifold as described in Section 17.
- 2 Disconnect the leak-off pipe(s) from the injector to be removed (see illustration).
- 3 Remove all traces of dirt from all the injector pipe unions. Unscrew the union nuts securing the injector pipes to the fuel injection pump and injectors (see illustration). Counterhold the adaptors on the pump, while unscrewing the pipe-to-pump union nuts. Remove the pipes as a set. Plug the injection pump/injector unions to prevent the entry of dirt.
- 4 On WJY engines, if No 1 injector is being removed trace the needle lift sensor wiring back from the injector and disconnect its wiring connector from the main harness.
- 5 Remove all traces of dirt from around the injector then unscrew the injector from the cylinder head. Recover the injector fire seal washer from the cylinder head and discard it; a new one must be used on refitting.

**Caution:** Take care not to drop the injectors, or allow the needles at their tips to become damaged. The injectors are precision-made to fine limits, and must not



15.15 Remove the retaining clip and disconnect the leak-off pipe connector from the injector – 2.0 litre models

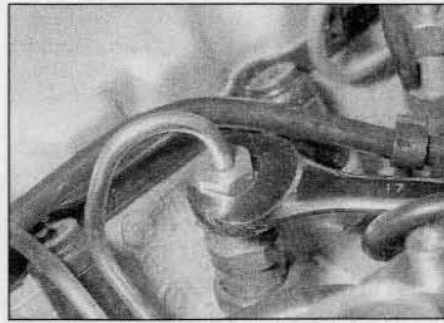

15.3 Unscrewing an injector pipe nut – 1.9 litre models

be handled roughly. In particular, never mount them in a bench vice.

#### Refitting

- 6 Fit the new fire seal washer ensuring its convex surface is facing upwards (towards the injector).
- 7 Carefully refit the injector to the cylinder head, tightening it to the specified torque.
- 8 Reconnect the leak-off pipe(s) to the injector. Where necessary, reconnect the needle lift sensor wiring connector.
- 9 With all the injectors correctly installed, refit and reconnect the injector pipes. Loosely tighten all the union nuts to ensure all pipes are correctly seated then go around and tighten them to the specified torque. Counterhold the injection pump adaptors whilst tightening the injection pump end nuts.
- 10 Refit the inlet manifold as described in Section 17.
- 11 Prime the fuel system as described in Section 6. Start the engine and check for signs of fuel leaks before refitting the engine cover.

### 2.0 litre models



**Warning:** Refer to the information contained in Section 2 before proceeding.

**Note:** The following procedure describes the removal and refitting of the injectors as a complete set, although each injector may be removed individually if required. New copper washers, upper seals, injector clamp retaining nuts and a high pressure fuel pipe will be required for each disturbed injector when refitting.

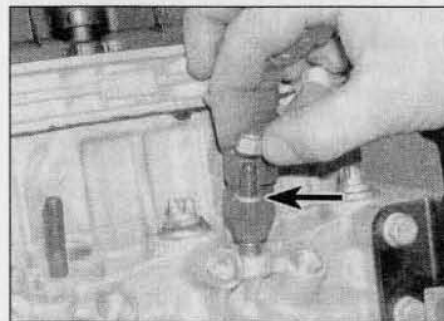

15.16 Slacken and remove the injector retaining nut and lift off the washer (arrowed) – 2.0 litre models

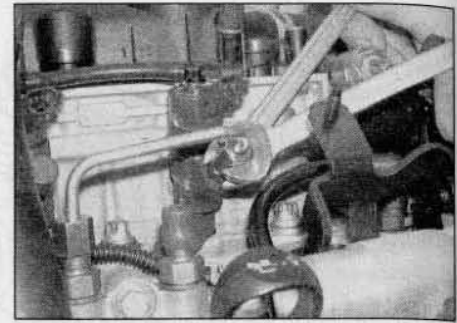

15.14 Retain the adaptors whilst slackening the union nuts then remove and discard the high-pressure pipe linking the injector to the fuel rail – 2.0 litre models

#### Removal

- 12 Carry out the operations described in Section 16, paragraphs 1 to 4.
- 13 At the connections above the fuel pump, disconnect the fuel supply and return hose quick-release fittings using a small screwdriver to release the locking clip. Suitably plug or cover the open unions to prevent dirt entry, then release the fuel hoses (and, on later models, the priming pump) from the relevant retaining clips.
- 14 Thoroughly clean all the high pressure fuel pipe unions on the fuel injectors and fuel rail. Using two open-ended spanners, unscrew the union nuts securing the high pressure fuel pipes to the fuel injectors and fuel rail (see illustration). Withdraw the high pressure fuel pipes and plug or cover the open unions on the injectors and fuel rail to prevent dirt entry. Note that a new high pressure fuel pipe will be required for each removed injector when refitting.
- 15 Extract the retaining circlip and disconnect the leak-off pipe from each fuel injector (see illustration).
- 16 Unscrew the nut and remove the washer securing each injector clamp to its cylinder head stud (see illustration). Note that new clamp nuts will be required for refitting.
- 17 Withdraw the injectors, together with their clamps, from the cylinder head (see illustration). Slide the clamp off the injector once it is clear of the mounting stud. If the injectors are a tight fit in the cylinder head and

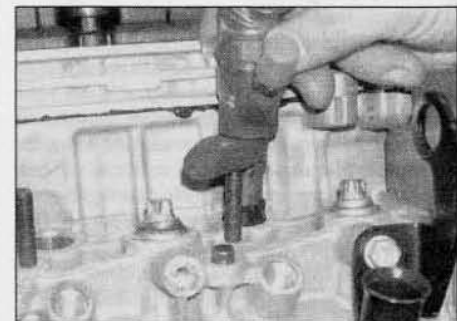

15.17 Remove the injector and retaining clamp from the cylinder head – 2.0 litre models

cannot be released, unscrew the mounting stud using a stud extractor and slide off the injector clamp. Using an open-ended spanner engaged with the clamp locating slot on the injector body, free the injector by twisting it and at the same time lifting it upwards.

**18** Recover the injector clamp locating dowel from the cylinder head (see illustration).

**19** Remove the copper washer and the upper seal from each injector, or from the cylinder head if they remained in place during injector removal. New copper washers and upper seals will be required for refitting.

**20** Examine each injector visually for any signs of obvious damage or deterioration. If any defects are apparent, renew the injector(s).

**Caution:** The injectors are manufactured to extremely close tolerances and must not be dismantled in any way. Do not unscrew the fuel pipe union on the side of the injector, or separate any parts of the injector body. Do not attempt to clean carbon deposits from the injector nozzle or carry out any form of ultrasonic or pressure testing.

**21** If the injectors are in a satisfactory condition, plug the fuel pipe union (if not already done) and suitably cover the electrical element and the injector nozzle.

**22** Prior to refitting, obtain new copper washers, upper seals, injector clamp retaining nuts and high pressure fuel pipes for each removed injector.

### Refitting

**23** Locate a new upper seal on the body of each injector, and place a new copper washer on the injector nozzle (see illustrations).

**24** Refit the injector clamp locating dowels to the cylinder head.

**25** Place the injector clamp in the slot on each injector body and refit the injectors to the cylinder head. Guide the clamp over the mounting stud and onto the locating dowel as each injector is inserted.

**26** Fit the washer and a new injector clamp retaining nut to each mounting stud. Tighten the nuts finger tight only at this stage.

**27** Working on one fuel injector at a time, remove the blanking plugs from the fuel pipe unions on the fuel rail and the relevant injector. Locate a new high pressure fuel pipe over the unions and screw on the union nuts. Take care not to cross-thread the nuts or strain the fuel pipes as they are fitted. Once the union nut threads have started, tighten the nuts moderately tight only at this stage.

**28** When all the fuel pipes are in place, tighten the injector clamp retaining nuts to the specified torque.

**29** Using an open-ended spanner, hold each fuel pipe union in turn and tighten the union nut to the specified torque using a torque wrench and crow-foot adaptor. Tighten all the disturbed union nuts in the same way.

**30** Connect the leak-off pipes to each fuel



**15.18** Recover the injector clamp locating dowel – 2.0 litre models

injector and secure with the retaining circlips.

**31** Remove the blanking plugs and reconnect the supply and return hose quick-release fittings at the connections above the fuel pump. Secure the hoses with their respective retaining clips.

**32** Reposition the plastic wiring harness guide over the two mounting studs and secure with the retaining nuts.

**33** Reconnect the fuel injector and pump piston de-activator switch wiring connectors, and reconnect any additional wiring disconnected for access.

**34** Check that everything has been reconnected and secured with the relevant retaining clips then reconnect the battery negative terminal.

**35** Observing the precautions listed in Section 2, prime the fuel system as described in Section 6, then start the engine and allow it to idle. Check for leaks at the high pressure fuel pipe unions with the engine idling. If satisfactory, increase the engine speed to 4000 rpm and check again for leaks. Take the car for a short road test and check for leaks once again on return. If any leaks are detected, obtain and fit additional new high pressure fuel pipes as required. **Do not** attempt to cure even the slightest leak by further tightening of the pipe unions.

**36** Refit the engine cover on completion.

### 16 Fuel rail (2.0 litre models) – removal and refitting



**Warning:** Refer to the information contained in Section 2 before proceeding.

**Note:** A complete new set of high pressure fuel pipes will be required for refitting.

#### Removal

**1** Disconnect the battery negative terminal (refer to *Disconnecting the battery* in the Reference Section of this manual).

**2** Undo the four plastic nuts and lift off the engine cover (see illustrations 3.20a and 3.20b).

**3** Disconnect the wiring connectors at the fuel injectors and at the piston de-activator

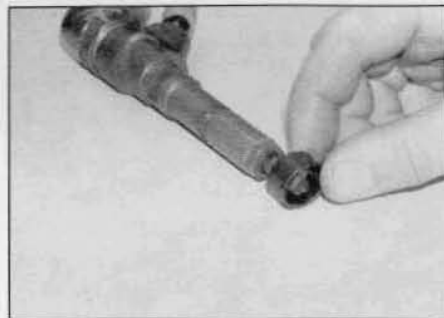

**15.23a** Slide the new upper seal onto the injector ...

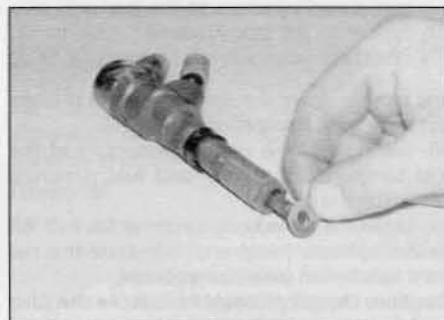

**15.23b** ... then fit the new copper washer – 2.0 litre models

switch on the top of the fuel pump.

**4** Undo the two nuts securing the plastic wiring harness guide to the cylinder head. Lift the guide off the two mounting studs and move it clear of the fuel rail. Disconnect any additional wiring connectors as necessary to enable the harness and guide assembly to be moved further for increased access.

**5** Release the retaining clip and disconnect the crankcase ventilation hose from the cylinder head cover.

**6** At the connections above the fuel pump, disconnect the fuel supply and return hose quick-release fittings using a small screwdriver to release the locking clip. Suitably plug or cover the open unions to prevent dirt entry.

**7** Similarly disconnect the supply and return hose quick-release fittings at the fuel filter and plug or cover the open unions. Release the fuel hoses (and, on later models, the priming pump) from the relevant retaining clips.

**8** Thoroughly clean all the high pressure fuel pipe unions on the fuel rail, fuel pump and injectors. Using an open-ended spanner, unscrew the union nuts securing the high pressure fuel pipe to the fuel pump and fuel rail. Counterhold the unions on the pump and fuel rail with a second spanner, while unscrewing the union nuts. Withdraw the high pressure fuel pipe and plug or cover the open unions to prevent dirt entry.

**9** Again using two spanners, hold the unions and unscrew the union nuts securing the high pressure fuel pipes to the fuel injectors and fuel rail. Withdraw the high pressure fuel pipes



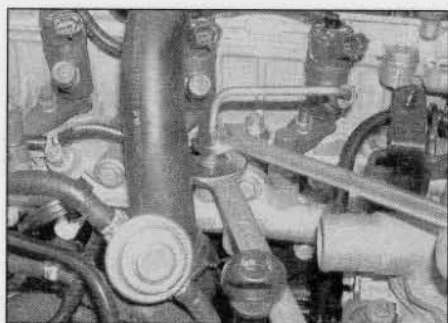

**16.9a** Retain the adaptors whilst slackening the union nuts then remove and discard the high-pressure pipes linking the pump and injectors to the fuel rail – 2.0 litre models

and plug or cover the open unions to prevent dirt entry (see illustrations).

**10** Disconnect the wiring connectors at the fuel temperature sensor and fuel pressure sensor on the fuel rail.

**11** Undo the three bolts securing the fuel rail to the cylinder head and withdraw the rail from its location (see illustrations).

**Caution:** Do not attempt to remove the four high pressure fuel pipe male unions from the fuel rail. These parts are not available separately and if disturbed are likely to result in fuel leakage on reassembly.

**12** Obtain a complete new set of high pressure fuel pipes for refitting.

### Refitting

**13** Locate the fuel rail in position, refit the three securing bolts and tighten to the specified torque.

**14** Working on one fuel injector at a time, remove the blanking plugs from the fuel pipe unions on the fuel rail and the relevant injector. Locate a new high pressure fuel pipe over the unions and screw on the union nuts finger tight at this stage.

**15** When all four fuel pipes are in place, hold the unions with a spanner and tighten the union nuts to the specified torque using a torque wrench and crow-foot adaptor (see illustration).

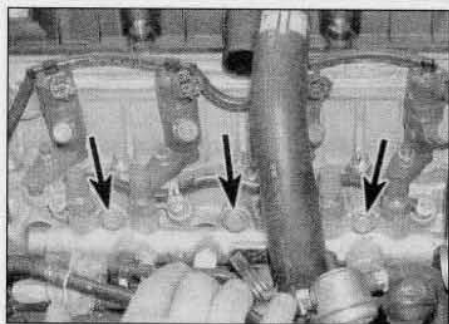

**16.11a** Undo the mounting bolts (arrowed) . . .

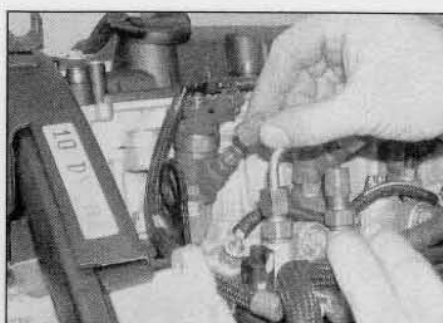

**16.9b** Plug/cap all unions to prevent the entry of dirt into the fuel system – 2.0 litre models

**16** Similarly, fit a new high pressure fuel pipe to the fuel pump and fuel rail, and tighten the union nuts to the specified torque.

**17** Reconnect the fuel temperature sensor and fuel pressure sensor wiring connectors.

**18** Remove the blanking plugs and reconnect the supply and return hose quick-release fittings at the fuel filter, and at the connections above the fuel pump. Secure the hoses with their respective retaining clips.

**19** Reconnect the crankcase ventilation hose to the cylinder head cover.

**20** Reposition the plastic wiring harness guide over the two mounting studs and secure with the retaining nuts.

**21** Reconnect the fuel injector and pump piston de-activator switch wiring connectors, and reconnect any additional wiring disconnected for access.

**22** Check that everything has been reconnected and secured with the relevant retaining clips then reconnect the battery negative terminal.

**23** Observing the precautions listed in Section 2, prime the fuel system as described in Section 6, then start the engine and allow it to idle. Check for leaks at the high pressure fuel pipe unions with the engine idling. If satisfactory, increase the engine speed to 4000 rpm and check again for leaks. Take the car for a short road test and check for leaks once again on return. If any leaks are detected, obtain and fit additional new high

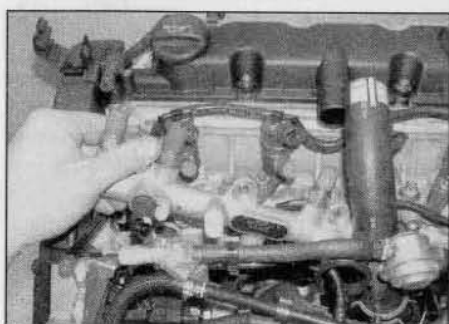

**16.11b** . . . and manoeuvre the fuel rail out of position – 2.0 litre models

pressure fuel pipes as required. Do not attempt to cure even the slightest leak by further tightening of the pipe unions.

**24** Refit the engine cover on completion.

### 17 Inlet manifold – removal and refitting

#### 1.9 litre models

##### Removal

**1** Disconnect the battery negative terminal (refer to *Disconnecting the battery* in the Reference Chapter).

**2** Release the fasteners from the right-hand side and top of the engine cover then lift off the cover, taking care not to lose its mounting rubbers (see illustrations 3.1a to 3.1c).

**3** Slacken the retaining clip and detach the intake duct from the EGR valve. Release the retaining clip and detach the EGR pipe from the side of the EGR valve. **Note:** If the pipe is secured in position with a crimped-type clip, discard the clip and obtain a new one for use on refitting.

**4** Disconnect the breather hose from the left-hand end of the manifold upper section.

**5** Unscrew the bolts securing the manifold upper section to the cylinder head and lower section.

**6** Remove the manifold upper section, complete with EGR valve, disconnecting the wiring connector and vacuum hose from the EGR valve solenoid. Recover the four seals fitted between the upper and lower sections.

**7** To remove the lower section of the manifold, unscrew the bolts securing the EGR pipe to the top of the exhaust manifold and the cylinder head cover. Free the pipe from the manifold and recover its gasket. Discard the gasket; a new one should be used on refitting.

**8** Slacken and remove the nuts and bolt securing the inlet manifold to the cylinder head. Remove the manifold and EGR pipe as an assembly. Recover the manifold gaskets and discard them; new ones must be used on refitting.



**16.15** Using a torque wrench and crow-foot adaptor, tighten the fuel pipe union nuts – 2.0 litre models

**Refitting**

9 Examine all the manifold studs for signs of damage and corrosion; remove all traces of corrosion, and repair or renew any damaged studs.

10 Ensure that the mating surfaces are clean and flat, and fit the new manifold gaskets.

11 Route the EGR pipe through the lower section of the manifold then install both as an assembly. Tighten the manifold retaining nuts and bolt to the specified torque.

12 Fit a new gasket to the exhaust manifold then reconnect the EGR pipe, tightening its retaining bolts securely.

13 Fit a new seal to each of the upper manifold section joints then refit the upper section of the manifold, reconnecting the wiring connector and vacuum hose to the EGR solenoid valve. Refit the retaining bolts, tightening them to the specified torque, and reconnect the breather hose.

14 Reconnect the intake duct and EGR pipe to the manifold upper section, secure them in position with their retaining clips.

15 Ensure the mounting rubbers are all correctly fitted then install the engine cover, securing it in position with the fasteners. Reconnect the battery negative terminal.

**2.0 litre models**

**Removal**

16 Remove the exhaust manifold as described in Section 18.

17 Slacken and remove the nuts and bolts securing the inlet manifold to the cylinder head (see illustration). Remove the manifold and recover the manifold gasket. Discard the gasket; a new one must be used on refitting.

**Refitting**

18 Examine all the manifold studs for signs of damage and corrosion; remove all traces of corrosion, and repair or renew any damaged studs.

19 Ensure that the mating surfaces are clean and flat, and fit the new manifold gasket.

20 Refit the manifold and tighten its retaining nuts and bolts to the specified torque.

21 Refit the exhaust manifold as described in Section 18.

**18 Exhaust manifold – removal and refitting**

**1.9 litre models**

**Removal**

1 Disconnect the battery negative terminal (refer to *Disconnecting the battery* in the Reference Chapter).

2 Release the fasteners from the right-hand side and top of the engine cover then lift off the cover, taking care not to lose its mounting rubbers (see illustrations 3.1a to 3.1c).

3 Release the retaining clip and detach the EGR pipe from the side of the EGR valve.

**Note:** If the pipe is secured in position with a crimped-type clip, discard the clip and obtain a new one for use on refitting

4 Unscrew the bolts securing the EGR pipe to the top of the exhaust manifold and the cylinder head cover. Free the pipe from the manifold and recover its gasket. Discard the gasket; a new one should be used on refitting.

5 Disconnect the exhaust front pipe from the manifold as described in Section 21.

6 Unscrew the exhaust manifold retaining nuts and remove the spacers from the manifold studs.

7 Remove the exhaust manifold and recover the manifold gaskets. Discard the gaskets; new ones must be used on refitting.

**Refitting**

8 Examine all the manifold studs for signs of damage and corrosion; remove all traces of corrosion, and repair or renew any damaged studs.

9 Ensure that the mating surfaces are clean and flat, and fit the new manifold gaskets.

10 Refit the manifold then fit the spacers to the mounting studs and screw on the retaining nuts. Tighten the nuts evenly and progressively to the specified torque.

11 Fit a new gasket then reconnect the EGR pipe to the manifold, tightening its retaining

bolts securely. Reconnect the pipe to the EGR valve, securing it in position with the retaining clip, and refit the bolt securing the pipe to the cylinder head cover.

12 Reconnect the exhaust front pipe as described in Section 21.

13 Refit the engine cover then reconnect the battery.

**2.0 litre models**

**Note:** The exhaust manifold is removed complete with the turbocharger and there is insufficient clearance to gain access to all the relevant attachments from either above or below with the engine in the car. Two alternatives are possible; either remove the complete engine/transmission unit from the car as described in Chapter 2E, or remove the front suspension subframe as described in Chapter 10. Both are involved operations and the course of action taken is largely dependent on the tools, equipment, skill and patience available.

**Removal**

14 The following procedure is based on the assumption that the engine/transmission unit has been removed from the car. If the front suspension subframe has been removed instead, the operations are basically the same, but it may be necessary to disconnect and move aside certain additional items, and to be prepared for considerable manipulation to withdraw the components from the engine compartment.

15 If the engine is in the car, disconnect the battery negative terminal (refer to *Disconnecting the battery* in the Reference Chapter).

16 If the engine is in the car, remove the exhaust system as described in Section 21.

17 Remove the turbocharger rear inlet and outlet ducts as described in Section 3.

18 Unscrew the union nut securing the turbocharger oil feed pipe to the cylinder block, then withdraw the pipe from its location (see illustration).

19 Remove the filter from the end of the oil feed pipe, and examine it for contamination (see illustration). Clean or renew if necessary.

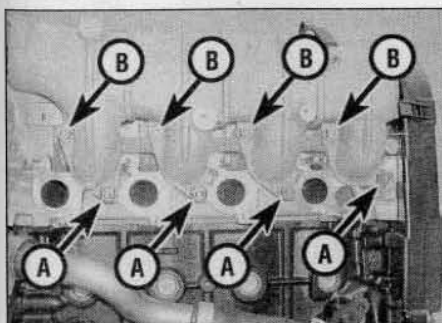

17.17 Inlet manifold retaining nuts (A) and bolts (B) – 2.0 litre models

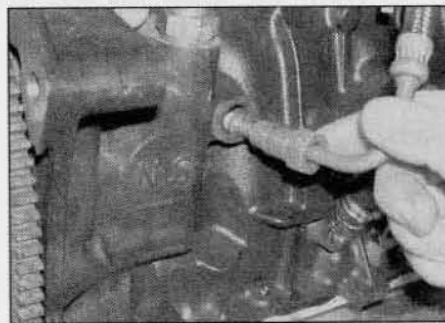

18.18 Unscrew the turbocharger oil feed pipe union nut – 2.0 litre models

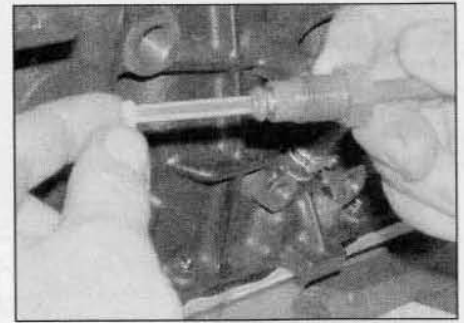

18.19 Withdraw the oil feed pipe and remove the filter – 2.0 litre models





18.20a Undo the oil return pipe flange securing bolts (arrowed) ...

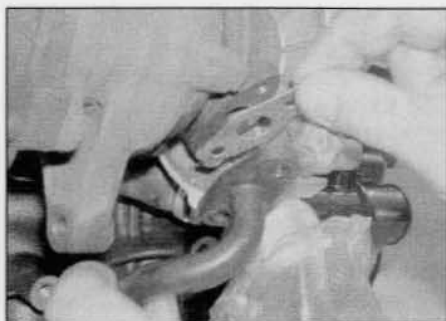

18.20b ... separate the flange and recover the gasket – 2.0 litre models

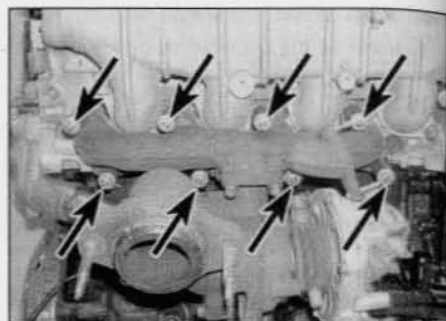

18.22a Undo the exhaust manifold retaining nuts (arrowed) ...

**20** Undo the two bolts securing the oil return pipe flange to the turbocharger. Separate the flange and recover the gasket (see illustrations).

**21** Remove the exhaust gas recirculation (EGR) valve and connecting pipe from the exhaust manifold as described in Chapter 4D, Section 3.

**22** Undo the eight exhaust manifold retaining nuts and recover the spacers from the studs (see illustrations).

**23** Undo the nut and bolt securing the base of the turbocharger to the support bracket on the cylinder block.

**24** Withdraw the turbocharger and exhaust manifold off the mounting studs and remove the assembly from the engine. Recover the manifold gasket (see illustrations).

#### Refitting

**25** Refitting is a reverse of the removal procedure, bearing in mind the following points:

- Ensure that the manifold and cylinder head mating faces are clean, with all traces of old gasket removed.
- Use new gaskets when refitting the manifold to the cylinder head and the oil return pipe flange to the turbocharger.
- Tighten the exhaust manifold retaining nuts to the specified torque.
- Refit the EGR valve and connecting pipe as described in Chapter 4D, Section 3.

e) Refit the turbocharger rear inlet and outlet ducts as described in Section 3.

f) If the engine is in the car, refit the exhaust system as described in Section 21.

g) Refit the engine/transmission unit or the front suspension subframe with reference to Chapter 2E or 10 as applicable.

### 19 Turbocharger (2.0 litre models) – description and precautions

#### Description

**1** A turbocharger is fitted to all 2.0 litre models. It increases engine efficiency by raising the pressure in the inlet manifold above atmospheric pressure. Instead of the air simply being sucked into the cylinders, it is forced in.

**2** Energy for the operation of the turbocharger comes from the exhaust gas. The gas flows through a specially-shaped housing (the turbine housing) and, in so doing, spins the turbine wheel. The turbine wheel is attached to a shaft, at the end of which is another vaned wheel known as the compressor wheel. The compressor wheel spins in its own housing, and compresses the inlet air on the way to the inlet manifold.

**3** Boost pressure (the pressure in the inlet manifold) is limited by a wastegate, which

diverts the exhaust gas away from the turbine wheel in response to a pressure-sensitive actuator.

**4** The turbo shaft is pressure-lubricated by an oil feed pipe from the main oil gallery. The shaft 'floats' on a cushion of oil. A drain pipe returns the oil to the sump.

#### Precautions

**5** The turbocharger operates at extremely high speeds and temperatures. Certain precautions must be observed, to avoid premature failure of the turbo, or injury to the operator.

**6** Do not operate the turbo with any of its parts exposed, or with any of its hoses removed. Foreign objects falling onto the rotating vanes could cause excessive damage, and (if ejected) personal injury.

**7** Do not race the engine immediately after start-up, especially if it is cold. Give the oil a few seconds to circulate.

**8** Always allow the engine to return to idle speed before switching it off – do not blip the throttle and switch off, as this will leave the turbo spinning without lubrication.

**9** Allow the engine to idle for several minutes before switching off after a high-speed run.

**10** Observe the recommended intervals for oil and filter changing, and use a reputable oil of the specified quality. Neglect of oil changing, or use of inferior oil, can cause carbon formation on the turbo shaft, leading to subsequent failure.

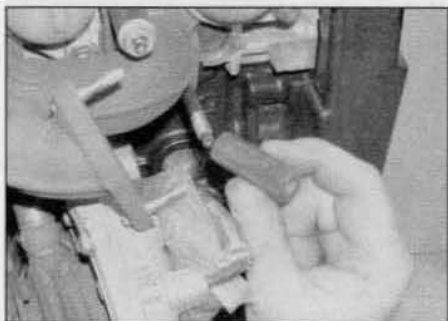

18.22b ... and recover the spacers – 2.0 litre models



18.24a Withdraw the turbocharger and manifold ...

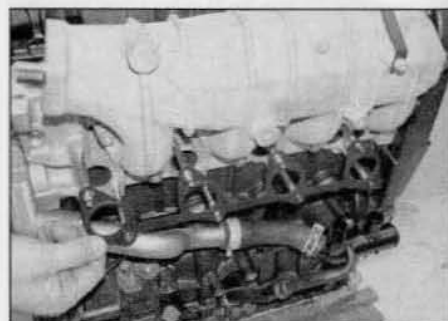

18.24b ... and recover the gasket – 2.0 litre models

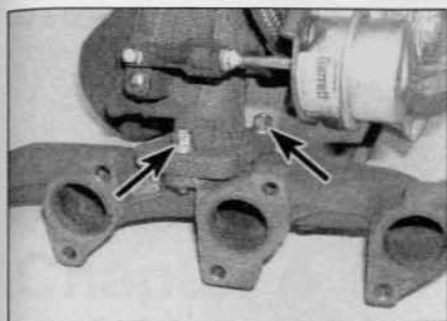

20.3 Turbocharger-to-exhaust manifold retaining nuts (arrowed)

**20 Turbocharger (2.0 litre models) – removal, inspection and refitting**

**Removal**

- 1 Remove the exhaust manifold as described in Section 18. The turbocharger and exhaust manifold are removed from the engine as a complete assembly. The turbocharger can then be separated from the manifold on the bench as follows.
- 2 Undo the four bolts securing the exhaust outlet elbow to the turbocharger body and separate the elbow from the turbocharger.
- 3 Undo the three retaining nuts and lift the turbocharger off the manifold studs (see illustration).

**Inspection**

- 4 With the turbocharger removed, inspect the housing for cracks or other visible damage.
- 5 Spin the turbine or the compressor wheel, to verify that the shaft is intact and to feel for excessive shake or roughness. Some play is normal, since in use, the shaft is 'floating' on a film of oil. Check that the wheel vanes are undamaged.
- 6 If oil contamination of the exhaust or induction passages is apparent, it is likely that turbo shaft oil seals have failed.
- 7 No DIY repair of the turbo is possible and none of the internal or external parts are available separately. If the turbocharger is suspect in any way a complete new unit must be obtained.

**Refitting**

- 8 Refitting is a reverse of the removal

procedure, bearing in mind the following points:

- a) If a new turbocharger is being fitted, change the engine oil and filter. Also renew the filter in the oil feed pipe.
- b) Prime the turbocharger by injecting clean engine oil through the oil feed pipe union before reconnecting the union.

**21 Exhaust system – general information, removal and refitting**

**General information**

- 1 According to model, the exhaust system consists of either two or three sections. Two section systems consist of a front pipe and tailpipe, and three section systems consist of a front pipe, intermediate pipe and tail pipe. Three section systems also incorporate a catalytic converter which is integral with either the front pipe or intermediate pipe.
- 2 The exhaust system joints are either of the spring-loaded ball type, to allow for movement in the exhaust system, or clamping ring type.
- 3 The system is suspended throughout its entire length by rubber mountings.
- 4 Each exhaust section can be removed individually or, alternatively, the complete system can be removed as a unit. Even if only one part of the system needs attention, it is often easier to remove the whole system and separate the sections on the bench.
- 5 To remove the system or part of the system, first jack up the front or rear of the car and support it on axle stands (see *Jacking and vehicle support*). Alternatively, position the car over an inspection pit or on car ramps.

**Front pipe**

- 6 On 1.9 litre models and early 2.0 litre models, undo the nuts securing the flange joint to the manifold, and recover the spring cups and springs. Remove the bolts and recover the wire-mesh gasket. On later 2.0 litre models, slacken and remove the nut washer and bolt from the clamping ring and disengage the clamp from the turbocharger flange joint.
- 7 Have an assistant support the front end of the pipe, then slacken and remove the nut, washer and bolt from the clamping ring and disengage the clamp from the flange joint.
- 8 Free the pipe from its mounting rubber(s)

and remove it from underneath the vehicle.

**Intermediate pipe**

- 9 Slacken the and remove the clamping ring nuts, washers bolts, and disengage both clamps from the flange joints.
- 10 Release the pipe from its mounting rubber and remove it from underneath the vehicle.

**Tailpipe**

- 11 Slacken and remove the nut, washer and bolt from the tailpipe clamping ring and disengage the clamp from the flange joint.
- 12 Unhook the tailpipe from its mounting rubbers and remove it from the vehicle.

**Complete system**

- 13 Separate the front pipe from the manifold/turbocharger as described previously.
- 14 With the aid of an assistant, free the system from all its mounting rubbers and lower it from under the vehicle. Recover the wire-mesh gasket from the manifold joint (where applicable).

**Heat shield(s)**

- 15 The heat shields are secured to the underside of the body by various nuts and fasteners. If a shield is being removed to gain access to a component located behind it, remove the retaining nuts and/or fastener (unscrew the centre screw then pull out the complete fastener), and manoeuvre the shield out of position. On some models it may be necessary to free the exhaust system from its mountings to gain the clearance necessary to remove the larger heat shield.

**Refitting**

- 16 Each section is refitted by reversing the removal sequence, noting the following points:
  - a) Ensure that all traces of corrosion have been removed from the flanges and renew all necessary gaskets.
  - b) Inspect the rubber mountings for signs of damage or deterioration, and renew as necessary.
  - c) Where joints are secured together by a clamping ring, apply a smear of exhaust system jointing paste to the flange joint to ensure a gas-tight seal.
  - d) Prior to tightening the exhaust system fasteners, ensure that all rubber mountings are correctly located, and that there is adequate clearance between the exhaust system and vehicle underbody.





# Chapter 4 Part D:

## Emission control systems

### Contents

	Section number		Section number
Catalytic converter – general information and precautions . . . . .	4	Emission control systems (petrol engines) –	
Emission control systems (diesel engines) –		testing and component renewal . . . . .	2
testing and component renewal . . . . .	3	General information . . . . .	1

### Degrees of difficulty

Easy, suitable for novice with little experience



Fairly easy, suitable for beginner with some experience



Fairly difficult, suitable for competent DIY mechanic



Difficult, suitable for experienced DIY mechanic



Very difficult, suitable for expert DIY or professional



### Specifications

#### Torque wrench settings

Air injection valve – 1.4 litre engine with secondary air injection:

	Nm	lbf ft
Valve-to-cylinder head bolts . . . . .	8	6
Valve-to-adaptor nuts . . . . .	7	5
Valve adaptor-to-exhaust manifold bolts . . . . .	7	5

#### 1 General information

All petrol engines have the ability to use unleaded petrol and also have various other features built into the fuel system to help minimise harmful emissions. In addition, all engines are equipped with the crankcase emission control system described below. All petrol engines are equipped with a catalytic converter and an evaporative emission control system. Certain later engines to emission standard L4, also utilise a secondary air injection system to quickly bring the catalytic converter up to normal working temperature.

All diesel engines are also designed to meet the strict emission requirements and are also equipped with a crankcase emission control system. To further reduce exhaust emissions, a catalytic converter and an exhaust gas recirculation (EGR) system are fitted to the majority of engines.

The emission control systems function as follows.

#### Petrol engines

##### Crankcase emission control

To reduce the emission of unburned hydrocarbons from the crankcase into the atmosphere, the engine is sealed and the blow-by gases and oil vapour are drawn from inside the crankcase, through a wire mesh oil separator, into the inlet tract to be burned by the engine during normal combustion.

Under conditions of high manifold depression (idling, deceleration) the gases will be sucked positively out of the crankcase. Under conditions of low manifold depression (acceleration, full-throttle running) the gases are forced out of the crankcase by the (relatively) higher crankcase pressure; if the engine is worn, the raised crankcase pressure (due to increased blow-by) will cause some of the flow to return under all manifold conditions.

##### Exhaust emission control

To minimise the amount of pollutants which escape into the atmosphere, a catalytic converter is fitted in the exhaust system. The

system is of the closed-loop type, in which one or two lambda sensors in the exhaust system provides the engine management ECU with constant feedback, enabling the ECU to adjust the air/fuel mixture ratio to provide the best possible conditions for the converter to operate.

The lambda sensor has a heating element built-in that is controlled by the ECU through the lambda sensor relay to quickly bring the sensor's tip to an efficient operating temperature. The sensor's tip is sensitive to oxygen and sends the ECU a varying voltage depending on the amount of oxygen in the exhaust gases; if the intake air/fuel mixture is too rich, the exhaust gases are low in oxygen so the sensor sends a low-voltage signal, the voltage rising as the mixture weakens and the amount of oxygen rises in the exhaust gases. Peak conversion efficiency of all major pollutants occurs if the intake air/fuel mixture is maintained at the chemically-correct ratio for the complete combustion of petrol of 14.7 parts (by weight) of air to 1 part of fuel (the 'stoichiometric' ratio). The sensor output voltage alters in a large step at this point, the



ECU using the signal change as a reference point and correcting the intake air/fuel mixture accordingly by altering the fuel injector pulse width.

### Evaporative emission control

To minimise the escape into the atmosphere of unburned hydrocarbons, an evaporative emission control system is fitted. The fuel tank filler cap is sealed and a charcoal canister is mounted underneath the right-hand front wing to collect the petrol vapours generated in the tank when the car is parked. It stores them until they can be cleared from the canister (under the control of the engine management ECU) via the purge valve into the inlet tract to be burned by the engine during normal combustion.

To ensure that the engine runs correctly when it is cold and/or idling and to protect the catalytic converter from the effects of an over-rich mixture, the purge control valve(s) is/are not opened by the ECU until the engine has warmed-up, and the engine is under load; the valve solenoid is then modulated on and off to allow the stored vapour to pass into the inlet tract.

### Secondary air injection

Certain later engines to emission standard L4 are also equipped with a secondary air injection system. This system is designed to reduce exhaust emissions in the period between first starting the engine, and until the catalytic converter reaches operating (functioning) temperature. Introduction of air into the exhaust system during the initial start-up period, creates an 'afterburner' effect which quickly increases the temperature in the exhaust system front pipe, thus bringing the catalytic converter up to normal operating temperatures very quickly.

The system consists of an air pump, an air injection valve, and interconnecting air hoses.

The system operates for between 10 and 45 seconds after engine start-up, dependant on coolant temperature.

### Diesel engines

#### Crankcase emission control

Refer to paragraphs 4 and 5.

#### Exhaust emission control

To minimise the level of exhaust pollutants released into the atmosphere, a catalytic converter is fitted in the exhaust system of later models.

The catalytic converter consists of a canister containing a fine mesh impregnated with a catalyst material, over which the hot exhaust gases pass. The catalyst speeds up the oxidation of harmful carbon monoxide, unburnt hydrocarbons and soot, effectively reducing the quantity of harmful products released into the atmosphere via the exhaust gases.

#### Exhaust gas recirculation system

This system is designed to recirculate small quantities of exhaust gas into the inlet tract, and therefore into the combustion process.

This process reduces the level of oxides of nitrogen present in the final exhaust gas which is released into the atmosphere.

The volume of exhaust gas recirculated is controlled by vacuum supplied from the brake servo vacuum pump, via a solenoid valve controlled by the glow plug preheating system, or by an electronic control unit.

A vacuum-operated valve is fitted to the exhaust manifold, to regulate the quantity of exhaust gas recirculated. The valve is operated by the vacuum supplied via the solenoid valve.

Additionally, on certain models, a butterfly valve mounted on the inlet manifold allows the ratio of air-to-recirculated exhaust gas to be controlled. The butterfly valve also enables the exhaust gases to be drawn into the inlet manifold at idle or under light load, when the valve on the exhaust manifold is fully open.

The system is controlled by an electronic control unit, which receives information on coolant temperature, engine load, and engine speed, via the coolant temperature switch/sensor, throttle position switch/sensor and crankshaft sensor respectively.

## 2 Emission control systems (petrol engines) - testing and component renewal

### Crankcase emission control

1 The components of this system require no attention other than to check that the hose(s) are clear and undamaged at regular intervals.

### Evaporative emission control system

#### Testing

2 If the system is thought to be faulty, disconnect the hoses from the charcoal canister and purge control valve and check that they are clear by blowing through them. If the purge control valve(s) or charcoal canister are thought to be faulty, they must be renewed.

#### Charcoal canister renewal

3 The charcoal canister is located behind the right-hand front wing. To gain access to the



2.5 To release the quick-release hose connectors, depress their centre collars with a small flat-bladed screwdriver

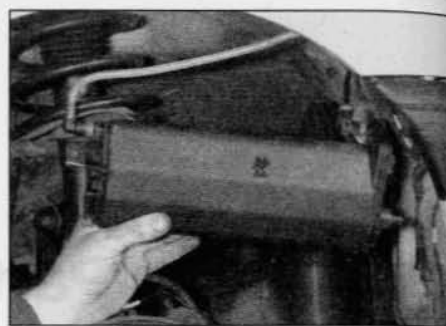

2.4 Lower the charcoal canister out from underneath the right-hand wing

canister, firmly apply the handbrake, then jack up the front of the car and support it securely on axle stands (see *Jacking and vehicle support*). Remove the roadwheel, then undo the retaining screws from the base of the wheel arch liner. Prise out the retaining clips and remove the liner from underneath the wing.

4 On early models, slacken and remove the retaining bolt then free the canister from its mounting clamp and lower it out from underneath the wing (see illustration). On later models, free the canister from its retaining clips, and lower it out from underneath the wing. On all models, mark the hoses for identification purposes.

5 Slacken the retaining clips then disconnect both hoses and remove the canister from the vehicle. Where the crimped-type hose clips are fitted, cut the clips and discard them, use standard worm-drive hose clips on refitting. Where the hoses are equipped with quick-release fittings depress the centre collar of the fitting with a small flat-bladed screwdriver then detach the hose from the canister (see illustration). On later models, also disconnect the purge valve wiring connector.

6 Refitting is a reverse of the removal procedure ensuring the hoses are correctly reconnected.

#### Purge valve(s) renewal

7 On early models, the purge valve is located on the right-hand side of the engine compartment (see illustration). On later models, the purge valve is integral with the



2.7 On early models, the purge valve (arrowed) is located on the right-hand side of the engine compartment

charcoal canister and cannot be renewed separately.

**8** To renew the purge valve on early models, first disconnect the battery negative terminal (refer to *Disconnecting the battery* in the Reference Chapter).

**9** Depress the retaining clip and disconnect the wiring connector from the valve. Disconnect the hoses from either end of the valve then release the valve from its retaining clip or strap and remove it from the engine compartment, noting which way around it is fitted.

**10** Refitting is a reversal of the removal procedure ensuring the valve is fitted the correct way around and the hoses are securely connected.

### Exhaust emission control

#### Testing

**11** The performance of the catalytic converter can only be checked by measuring the exhaust gases using a good-quality, carefully-calibrated exhaust gas analyser. If access to such equipment can be gained, it should be connected and used according with the maker's instructions.

**12** If the CO level at the tailpipe is too high, the vehicle should be taken to a Peugeot/Citroën dealer or engine diagnostic specialist so that the complete engine management system can be thoroughly checked using the special diagnostic equipment. Once these have been checked and are known to be free from faults, the fault must be in the catalytic converter, which must be renewed as described in Chapter 4A.

#### Catalytic converter renewal

**13** Refer to Chapter 4A.

#### Lambda sensor(s) renewal

**Note 1:** The lambda sensor is delicate and will not work if it is dropped or knocked, if its power supply is disrupted, or if any cleaning materials are used on it.

**Note 2:** Later engines to emission standard L4 are fitted with a 'downstream' lambda sensor located after the catalytic converter. Removal and refitting procedures are the same for both sensors.

**14** Trace the wiring back from the lambda sensor (which is screwed into the top of the exhaust front pipe or into the exhaust manifold) to the top of the transmission unit. Disconnect both wiring connectors and free the wiring from any relevant retaining clips or ties (see illustration).

**15** Unscrew the sensor from the exhaust system front pipe or manifold and remove it along with its sealing washer.

**16** Refitting is a reverse of the removal procedure using a new sealing washer. Prior to installing the sensor apply a smear of high-temperature grease to the sensor threads. Ensure the sensor is securely tightened and that the wiring is correctly routed and in no danger of contacting either the exhaust system or engine.

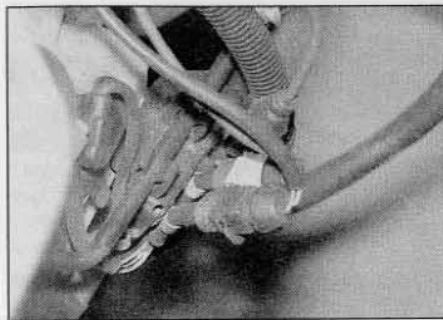

**2.14** On early models the lambda sensor wiring connectors are clipped onto the front of the transmission

### Secondary air injection

#### Testing

**17** If the air injection pump is thought not to be operating correctly, the vehicle should be taken to a Peugeot/Citroën dealer or engine diagnostic specialist so that the complete engine management system, including the pump, can be thoroughly checked using the special diagnostic equipment (see Chapter 4A).

**18** The air injection valve can be checked once it has been removed. The valve should flow air only in one direction; when blown through from the valve (pump) union. If not, it is faulty and should be renewed.

#### Air pump renewal

**19** The air pump is located on the left-hand side of the engine compartment.

**20** To gain access to the pump, remove the air cleaner housing as described in Chapter 4A.

**21** Unscrew the mounting bolts then disconnect the vacuum hoses and wiring

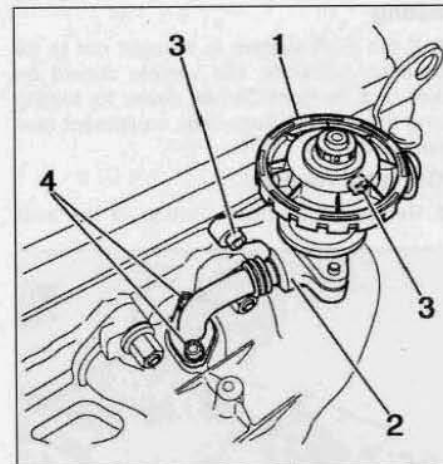

**2.25** Secondary air injection valve – later 1.4 litre models

- 1 Air injection valve
- 2 Valve adaptor
- 3 Valve-to-cylinder head bolts
- 4 Adaptor-to-manifold bolts

connector and remove the pump from the vehicle.

**22** Refitting is the reverse of removal.

#### Air injection valve renewal

**23** The air injection valve is mounted on the front of the cylinder head.

**24** Disconnect the air hose from the valve.

**25** Unscrew the bolts securing the valve adaptor to the top of the exhaust manifold (see illustration).

**26** Unscrew the bolts securing the valve to the front of the cylinder head then remove the valve and adaptor assembly from the engine.

**27** If necessary, unscrew the retaining nuts and separate the valve and adaptor. Recover the gasket and discard it; a new one should be used on refitting.

**28** Refitting is the reverse of removal, using a new gasket (where necessary) and tighten the fixings to the specified torque.

### 3 Emission control systems (diesel engines) – testing and component renewal

**Note:** Numerous variations of emission control systems have been fitted during the course of production. The following information is a guide to the systems most commonly encountered.

#### Crankcase emission control

**1** The components of this system require no attention other than to check that the hose(s) are clear and undamaged at regular intervals.

#### Exhaust emission control

##### Testing

**2** The performance of the catalytic converter can only be checked by measuring the exhaust gases using a good-quality, carefully-calibrated exhaust gas analyser. If access to such equipment can be gained, it should be connected and used according with the maker's instructions.

**3** If the exhaust emissions are excessive, before assuming the catalytic converter is faulty, it is worth checking the problem is not due to a faulty injector(s), or other diesel fuel system fault. Refer to your Peugeot/Citroën dealer for further information.

#### Catalytic converter renewal

**4** Refer to Chapter 4B or 4C as applicable.

#### EGR system – 1.9 litre DJY engine models

##### Testing

**5** If the EGR system is thought not to be operating correctly, the vehicle should be taken to a Peugeot/Citroën dealer for testing.

#### EGR valve renewal

**6** Disconnect the battery negative terminal (refer to *Disconnecting the battery* in the Reference Section of this manual).



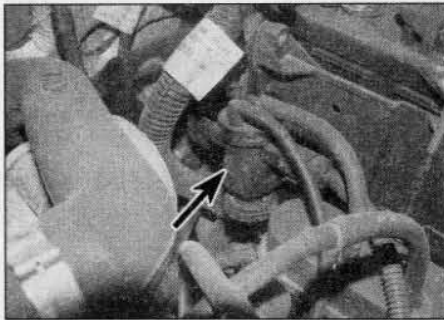

**3.22** The EGR solenoid valve (arrowed) is located on the battery mounting plate – 1.9 litre models

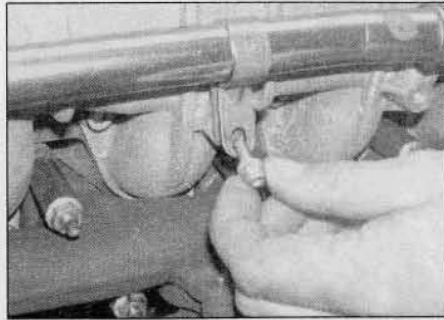

**3.27** Undo the bolts securing the EGR pipe support clips to the inlet manifold . . .

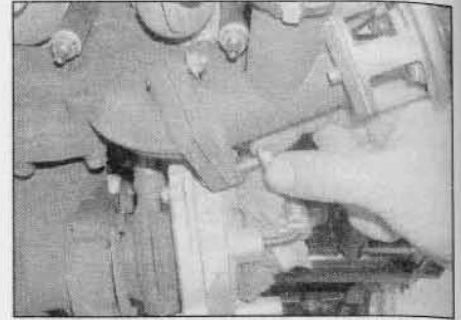

**3.28** . . . and the two nuts securing the EGR valve to the exhaust manifold – 2.0 litre models

**7** Remove the air inlet duct and air distribution housing as described in Chapter 4B.

**8** Remove the cylinder head cover as described in Chapter 2B.

**9** Remove the clip securing the lower flexible portion of the EGR pipe to the EGR valve. If the original crimped clip is still in place, cut it off; new clips are supplied by Peugeot/Citroën parts stockists with a screw clamp fixing. If a screw clamp type clip is fitted, undo the screw and manipulate the clip off the pipe.

**10** Disconnect the vacuum hose from the top of the EGR valve.

**11** Undo the two bolts securing the EGR valve to the exhaust manifold. Lift off the valve and recover the gasket.

**12** Refitting is a reverse of the removal procedure, bearing in mind the following points:

- a) Ensure that the EGR valve and exhaust manifold mating faces are clean and use a new gasket.
- b) Secure the EGR pipe with new screw clamp type clips, if crimped type clips were initially fitted.
- c) Refit the cylinder head cover as described in Chapter 2B.
- d) Refit the air inlet duct and air distribution housing as described in Chapter 4B.

**EGR solenoid valve renewal**

**13** To remove the EGR solenoid valve, disconnect the two vacuum hoses and the wiring connector. Undo the mounting nuts

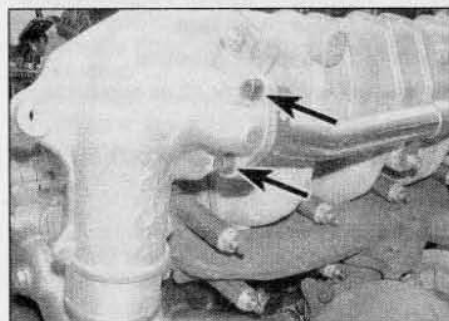

**3.29a** Undo the two bolts (arrowed) securing the EGR pipe to the inlet manifold elbow . . .

and remove the valve from the mounting bracket.

**14** Refitting is the reverse of removal.

**EGR system – 1.9 litre WJZ engine models**

**Testing**

**15** If the EGR system is thought not to be operating correctly, the vehicle should be taken to a Peugeot/Citroën dealer for testing.

**EGR valve renewal**

**16** Remove the upper section of the inlet manifold as described in Chapter 4C. The EGR valve can then be removed from the manifold.

**17** Refitting is the reverse of removal.

**Accelerator lever switch renewal**

**18** The switch is fitted to the top of the injection pump. If the switch is faulty, renewal should be entrusted to a Peugeot/Citroën dealer who will have the necessary special equipment to adjust it.

**EGR system – 1.9 litre WJY engine models**

**Testing**

**19** If the EGR system is thought not to be operating correctly, the vehicle should be taken to a Peugeot/Citroën dealer for testing using the special diagnostic equipment (see Chapter 4C).

**EGR valve renewal**

**20** Remove the upper section of the inlet



**3.29b** . . . then withdraw the valve and pipe assembly and recover the gasket at the EGR pipe flange – 2.0 litre models

manifold as described in Chapter 4C. The EGR valve can then be removed from the manifold.

**21** Refitting is the reverse of removal.

**Solenoid valve renewal**

**22** The EGR solenoid valve is located on the battery mounting plate (see illustration).

**23** To remove the EGR solenoid valve, disconnect the two vacuum hoses and the wiring connector. Undo the mounting bracket bolts and remove the valve from the engine compartment.

**24** Refitting is the reverse of removal.

**EGR system – 2.0 litre models**

**Testing**

**25** Testing of the system should be entrusted to a Peugeot/Citroën dealer.

**EGR valve renewal**

**26** Disconnect the battery negative terminal (refer to *Disconnecting the battery* in the Reference Chapter).

**27** Undo the bolts securing the EGR pipe support clips to the inlet manifold (see illustration).

**28** Disconnect the vacuum hose, then undo the two nuts securing the EGR valve to the exhaust manifold (see illustration).

**29** Undo the two bolts securing the EGR pipe to the inlet manifold elbow. Withdraw the EGR valve and pipe assembly from the manifold and recover the gasket at the EGR pipe-to-inlet manifold flange (see illustrations).

**30** To separate the EGR pipe from the valve, remove the clip securing the upper flexible portion of the pipe to the valve. If the original crimped clip is still in place, cut it off; new clips are supplied by Peugeot/Citroën parts stockists with a screw clamp fixing. If a screw clamp type clip is fitted, undo the screw and manipulate the clip off the pipe.

**31** Refitting is a reverse of the removal procedure, bearing in mind the following points:

- a) Ensure that the EGR valve and exhaust manifold mating faces are clean.
- b) Secure the EGR pipe with new screw clamp type clips, if crimped type clips were initially fitted.



**3.32 EGR solenoid valve location (arrowed) on the battery mounting plate – 2.0 litre models**

#### Solenoid valve renewal

**32** The EGR solenoid valve is located on the battery mounting plate (see illustration). To gain access, remove the air cleaner assembly as described in Chapter 4C.

**33** To remove the EGR solenoid valve, disconnect the two vacuum hoses and the wiring connector. Undo the mounting bracket bolts and remove the valve from the engine compartment.

**34** Refitting is the reverse of removal.

#### 4 Catalytic converter – general information and precautions

**1** The catalytic converter is a reliable and simple device which needs no maintenance in itself, but there are some facts of which an owner should be aware if the converter is to function properly for its full service life.

##### Petrol engines

- a) *DO NOT use leaded petrol or LRP in a car equipped with a catalytic converter – the lead will coat the precious metals, reducing their converting efficiency and will eventually destroy the converter.*
- b) *Always keep the Ignition and fuel systems well-maintained in accordance with the manufacturer's schedule.*
- c) *If the engine develops a misfire, do not drive the car at all (or at least as little as possible) until the fault is cured.*
- d) *DO NOT push- or tow-start the car – this will soak the catalytic converter in unburned fuel, causing it to overheat when the engine does start.*
- e) *DO NOT switch off the ignition at high engine speeds.*

- f) *DO NOT use fuel or engine oil additives – these may contain substances harmful to the catalytic converter.*
- g) *DO NOT continue to use the car if the engine burns oil to the extent of leaving a visible trail of blue smoke.*
- h) *Remember that the catalytic converter operates at very high temperatures. DO NOT, therefore, park the car in dry undergrowth, over long grass or piles of dead leaves after a long run.*
- i) *Remember that the catalytic converter is FRAGILE – do not strike it with tools during servicing work.*
- j) *In some cases a sulphurous smell (like that of rotten eggs) may be noticed from the exhaust. This is common to many catalytic converter-equipped cars and once the car has covered a few thousand miles the problem should disappear.*
- k) *The catalytic converter, used on a well-maintained and well-driven car, should last for between 50 000 and 100 000 miles – if the converter is no longer effective it must be renewed.*

##### Diesel engines

**2** Refer to parts f, g, h and i of the petrol engine information given above.





# Chapter 5 Part A:

## Starting and charging systems

### Contents

	Section number		Section number
Alternator – removal and refitting .....	8	General information and precautions .....	1
Alternator – testing and overhaul .....	9	Ignition switch – removal and refitting .....	13
Alternator drivebelt – removal, refitting and tensioning .....	7	Oil level sensor – removal and refitting .....	15
Battery – removal and refitting .....	4	Oil pressure warning light switch – removal and refitting .....	14
Battery tray and mounting plate – removal and refitting .....	5	Starter motor – removal and refitting .....	11
Battery – testing and charging .....	3	Starter motor – testing and overhaul .....	12
Charging system – testing .....	6	Starting system – testing .....	10
Electrical fault finding – general information .....	2		

### Degrees of difficulty

**Easy**, suitable for novice with little experience



**Fairly easy**, suitable for beginner with some experience



**Fairly difficult**, suitable for competent DIY mechanic



**Difficult**, suitable for experienced DIY mechanic



**Very difficult**, suitable for expert DIY or professional



### Specifications

<b>System type</b> .....	12 volt, negative earth
<b>Battery</b>	
Type .....	Low maintenance or 'maintenance-free' sealed for life
Charge condition:	
Poor .....	12.5 volts
Normal .....	12.6 volts
Good .....	12.7 volts
<b>Alternator</b>	
Type .....	Denso, Valeo, Bosch, Magneti Marelli or Mitsubishi (depending on model)
Rating:	
Petrol engines .....	70, 80 or 90 amp
Diesel engines .....	70, 80, 90, 120 or 150 amp
<b>Starter motor</b>	
Type .....	Mitsubishi, Valeo, Paris Rhone or Bosch (depending on model)



## 1 General information and precautions

### General information

The engine electrical system consists mainly of the charging and starting systems. Because of their engine-related functions, these components are covered separately from the body electrical devices such as the lights, instruments, etc (which are covered in Chapter 12). On petrol engine models refer to Part B for information on the ignition system, and on diesel models refer to Part C for information on the pre/post-heating system.

The electrical system is of the 12 volt negative earth type.

The battery is of the low maintenance or 'maintenance-free' (sealed for life) type and is charged by the alternator, which is belt-driven from the crankshaft pulley.

The starter motor is of the pre-engaged type incorporating an integral solenoid. On starting, the solenoid moves the drive pinion into engagement with the flywheel ring gear before the starter motor is energised. Once the engine has started, a one-way clutch prevents the motor armature being driven by the engine until the pinion disengages from the flywheel.

### Precautions

Further details of the various systems are given in the relevant Sections of this Chapter. While some repair procedures are given, the usual course of action is to renew the component concerned. The owner whose interest extends beyond mere component renewal should obtain a copy of the *Automotive Electrical & Electronic Systems Manual*, available from the publishers of this manual.

It is necessary to take extra care when working on the electrical system to avoid damage to semi-conductor devices (diodes and transistors), and to avoid the risk of personal injury. In addition to the precautions given in *Safety first!* at the beginning of this manual, observe the following when working on the system:

- **Always remove rings, watches, etc, before working on the electrical system. Even with the battery disconnected, capacitive discharge could occur if a component's live terminal is earthed through a metal object. This could cause a shock or nasty burn.**

- **Do not reverse the battery connections. Components such as the alternator, electronic control units, or any other components having semi-conductor circuitry could be irreparably damaged.**

- **If the engine is being started using jump leads and a slave battery, connect the batteries positive-to-positive and negative-to-negative (see 'Jump starting'). This also applies when connecting a battery charger.**

- **Never disconnect the battery terminals, the alternator, any electrical wiring or any test instruments when the engine is running.**

- **Do not allow the engine to turn the alternator when the alternator is not connected.**

- **Never 'test' for alternator output by 'flashing' the output lead to earth.**

- **Never use an ohmmeter of the type incorporating a hand-cranked generator for circuit or continuity testing.**

- **Always ensure that the battery negative lead is disconnected when working on the electrical system.**

- **Before using electric-arc welding equipment on the car, disconnect the battery, alternator and components such as the various vehicle electronic control units to protect them from the risk of damage.**

## 2 Electrical fault finding – general information

Refer to Chapter 12.

## 3 Battery – testing and charging

### Testing

#### Standard and low maintenance battery

1 If the vehicle covers a small annual mileage, it is worthwhile checking the specific gravity of the electrolyte every three months to determine the state of charge of the battery. Use a hydrometer to make the check and compare the results with the following table. Note that the specific gravity readings assume an electrolyte temperature of 15°C (60°F); for every 10°C (18°F) below 15°C (60°F) subtract 0.007. For every 10°C (18°F) above 15°C (60°F) add 0.007.

	Above 25°C	Below 25°C
Fully-charged	1.210 to 1.230	1.270 to 1.290
70% charged	1.170 to 1.190	1.230 to 1.250
Discharged	1.050 to 1.070	1.110 to 1.130

2 If the battery condition is suspect, first check the specific gravity of electrolyte in each cell. A variation of 0.040 or more between any cells indicates loss of electrolyte or deterioration of the internal plates.

3 If the specific gravity variation is 0.040 or more, the battery should be renewed. If the cell variation is satisfactory but the battery is discharged, it should be charged as described later in this Section.

#### Maintenance-free battery

4 In cases where a 'sealed for life' maintenance-free battery is fitted, topping-up and testing of the electrolyte in each cell is not possible. The condition of the battery can therefore only be tested using a battery condition indicator or a voltmeter.

5 Certain models may be fitted with a 'Delco' type maintenance-free battery, with a built-in charge condition indicator. The indicator is located in the top of the battery casing, and indicates the condition of the battery from its colour. If the indicator shows green, then the battery is in a good state of charge. If the indicator shows black, then the battery requires charging, as described later in this Section. If the indicator shows blue, then the electrolyte level in the battery is too low to allow further use, and the battery should be renewed.

**Caution: Do not attempt to charge, load or jump start a battery when the indicator shows clearly yellow.**

6 If testing the battery using a voltmeter, connect the voltmeter across the battery and compare the result with those given in the Specifications under 'charge condition'. The test is only accurate if the battery has not been subjected to any kind of charge for the previous six hours. If this is not the case, switch on the headlights for 30 seconds, then wait four to five minutes before testing the battery after switching off the headlights. All other electrical circuits must be switched off, so check that the doors and tailgate are fully shut when making the test.

7 If the voltage reading is less than 12.2 volts, then the battery is discharged, whilst a reading of 12.2 to 12.4 volts indicates a partially-discharged condition.

8 If the battery is to be charged, remove it from the vehicle (Section 4) and charge it as described later in this Section.

### Charging

**Note:** *The following is intended as a guide only. Always refer to the manufacturer's recommendations (often printed on a label attached to the battery) before charging a battery.*

#### Standard and low maintenance battery

9 Charge the battery at a rate of 3.5 to 4 amps and continue to charge the battery at this rate until no further rise in specific gravity is noted over a four hour period.

10 Alternatively, a trickle charger charging at the rate of 1.5 amps can safely be used overnight.

11 Specially rapid 'boost' charges which are claimed to restore the power of the battery in 1 to 2 hours are not recommended, as they can cause serious damage to the battery plates through overheating.

12 While charging the battery, note that the temperature of the electrolyte should never exceed 37.8°C (100°F).

#### Maintenance-free battery

13 This battery type takes considerably longer to fully recharge than the standard type, the time taken being dependent on the extent of discharge, but it can take anything up to three days.

14 A constant voltage type charger is required to be set, when connected, to 13.9 to

14.9 volts with a charger current below 25 amps. Using this method, the battery should be usable within three hours, giving a voltage reading of 12.5 volts, but this is for a partially-discharged battery and, as mentioned, full charging can take considerably longer.

**15** If the battery is to be charged from a fully discharged state (condition reading less than 12.2 volts), have it recharged by your Peugeot/Citroën dealer or local automotive electrician, as the charge rate is higher and constant supervision during charging is necessary.

#### 4 Battery – removal and refitting

**Note:** Refer to 'Disconnecting the battery' in the Reference Chapter before proceeding.

##### Removal

**1** The battery is located on the left-hand side of the engine compartment.

**2** Slacken the clamp bolt and disconnect the clamp from the battery negative (-) terminal (see illustration).

**3** Disconnect the battery positive terminal (+) lead. The positive terminal attachment will either be of the clamp bolt type described in paragraph 2, or of the quick release type, whereby lifting the plastic insulation cover automatically releases the terminal clamp (see illustration).

**4** On early models, undo the nut and bolt and lift the battery clamp off the retaining stud (see illustration). Lift the battery out of the engine compartment.

**5** On later models, undo the nut securing the battery clamp to the battery tray stud and lift out the clamp (see illustration). Move the battery towards the engine slightly to disengage the lip on the battery case from the battery tray, then lift the battery out of the engine compartment.

##### Refitting

**6** Refitting is a reversal of removal, but smear petroleum jelly on the terminals after reconnecting the leads, and always reconnect the positive lead first, and the negative lead last.

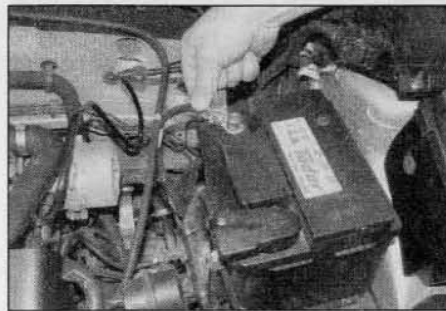

**4.2** Slacken the clamp bolt nut and disconnect the negative lead from the battery terminal

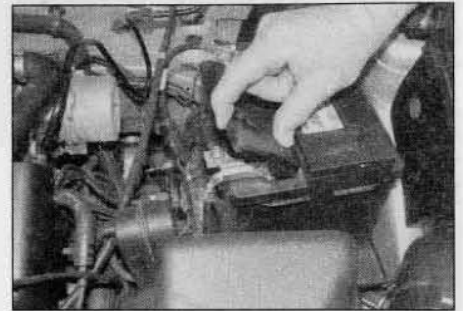

**4.3** Lift the plastic insulation cover to disconnect the quick-release positive lead clamp from the battery terminal

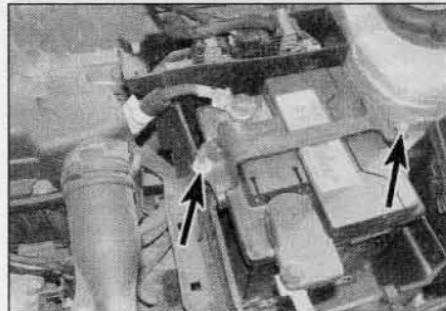

**4.4** Battery clamp retaining nut and bolt (arrowed) on early models . . .

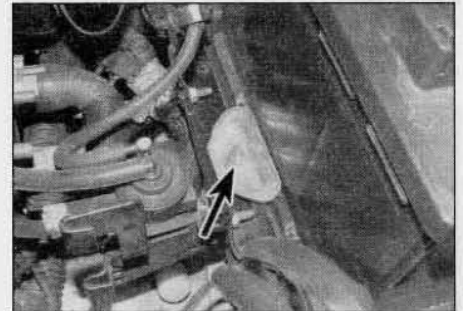

**4.5** . . . and clamp retaining nut (arrowed) on later models

#### 5 Battery tray and mounting plate – removal and refitting

**Note:** The battery tray and mounting plate arrangement varies considerably according to model and year of manufacture. The following procedures describe typical arrangements that may be encountered.

##### Removal

**1** Remove the battery as described in Section 4.  
**2** Referring to the relevant Part of Chapter 4, remove the air cleaner and air intake duct components as necessary for access to the battery tray.

**3** On models where the engine management electronic control unit (ECU) is housed in the

end of the battery tray, lift off the cover and disconnect the wiring connector(s) from the ECU. Alternatively, undo the ECU support plate bolts and separate the support plate from the battery tray.

**4** Release all the relevant clips securing the wiring to the tray and remove the battery tray from the engine compartment.

**5** To remove the mounting plate, undo the bolts securing the mounting plate to the top of the left-hand engine/transmission mounting (see illustration).

**6** On diesel engine models, undo the retaining nuts and bolts and remove the vacuum reservoir and solenoid valves from the side of the mounting plate (see illustration).

**7** On later 2.0 litre diesel models, unclip the relay box from the front of the mounting plate (see illustration).

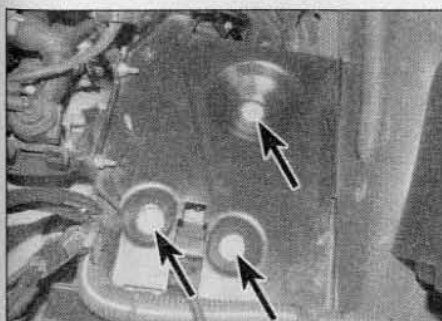

**5.5** Undo the bolts (arrowed) securing the mounting plate to the top of the engine/transmission mounting

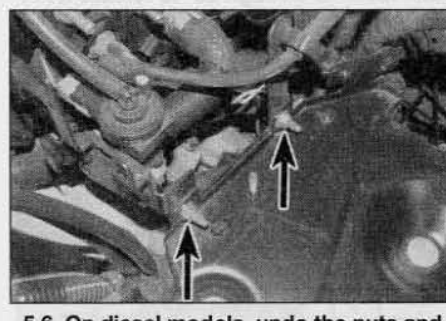

**5.6** On diesel models, undo the nuts and bolts (arrowed) and remove the vacuum reservoir and solenoid valves from the mounting plate

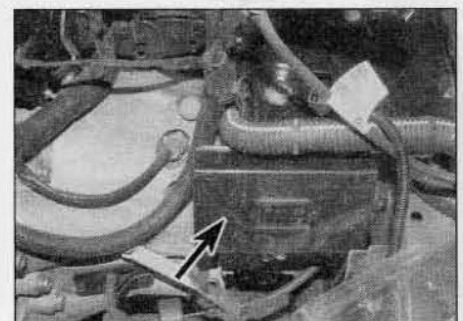

**5.7** On later 2.0 litre diesel models, unclip the relay box (arrowed) from the front of the mounting plate



8 Release any additional wiring retaining clips and withdraw the mounting plate from the engine compartment.

**Refitting**

9 Refitting is a reversal of removal, ensuring that the mounting plate retaining bolts are securely tightened.

**6 Charging system – testing**

**Note:** Refer to the warnings given in 'Safety first!' and in Section 1 of this Chapter before starting work.

1 If the ignition warning light fails to illuminate when the ignition is switched on, first check the alternator wiring connections for security.

If satisfactory, check that the warning light bulb has not blown, and that the bulbholder is secure in its location in the instrument panel. If the light still fails to illuminate, check the continuity of the warning light feed wire from the alternator to the bulbholder. If all is satisfactory, the alternator is at fault and should be renewed or taken to an auto-electrician for testing and repair.

2 If the ignition warning light illuminates when the engine is running, stop the engine and check that the drivebelt is correctly fitted and tensioned (see Chapter 1A or 1B) and that the alternator connections are secure. If all is so far satisfactory, have the alternator checked by an auto-electrician for testing and repair.

3 If the alternator output is suspect even though the warning light functions correctly, the regulated voltage may be checked as follows.

4 Connect a voltmeter across the battery terminals and start the engine.

5 Increase the engine speed until the voltmeter reading remains steady; the reading should be approximately 12 to 13 volts, and no more than 14 volts.

6 Switch on as many electrical accessories (eg, the headlights, heated rear window and heater blower) as possible, and check that the alternator maintains the regulated voltage of around 13 to 14 volts.

7 If the regulated voltage is not as stated, the fault may be due to worn brushes, weak brush springs, a faulty voltage regulator, a faulty diode, a severed phase winding or worn or damaged slip-rings. The alternator should be renewed or taken to an auto-electrician for testing and repair.

**7 Alternator drivebelt – removal, refitting and tensioning**

Refer to the procedure given for the auxiliary drivebelt in Chapter 1A or 1B.

**8 Alternator – removal and refitting**

**Removal**

1 Disconnect the battery negative terminal (refer to *Disconnecting the battery* in the Reference Chapter).

2 Remove the auxiliary drivebelt as described in Chapter 1A or 1B.

3 On 1.9 litre DW series diesel engines, release the clip in the centre of the engine cover and undo the retaining screw on the right-hand side. Lift off the engine cover. On 2.0 litre diesel engines, turn the four plastic fasteners through 90° and lift off the engine cover (see illustrations).

4 For improved access to the alternator on models with power steering, refer to Chapter 10 and unbolt the power steering pump from its location. Move the pump to one side, taking care not to lose the spacer (where fitted) from the rear mounting (see illustrations). Support

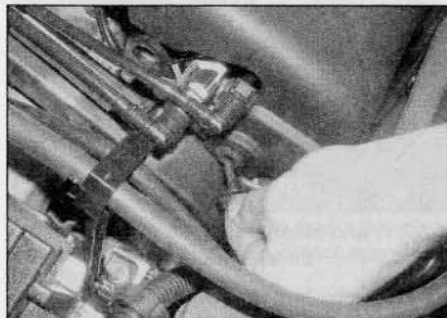

8.3a On 1.9 litre DW series diesel engines, remove the fasteners from the right-hand side ...



8.3b ... and top of the engine cover ...

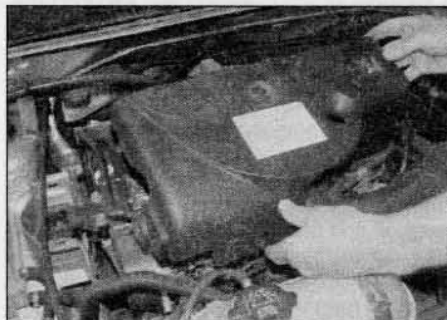

8.3c ... then remove the cover from the engine



8.3d On 2.0 litre diesel engines, rotate each fastener through 90° to release it ...

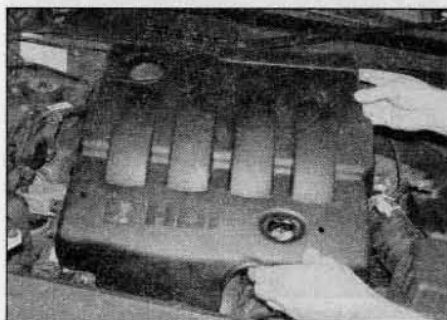

8.3e ... then lift off the engine cover



8.4a Slacken and remove the power steering pump front mounting bolts ...

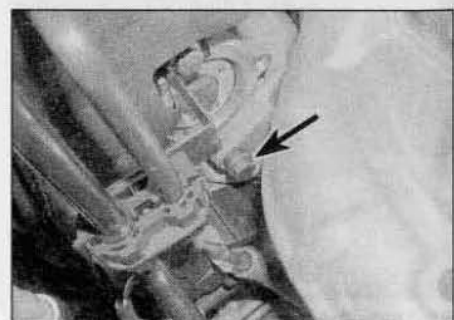

8.4b ... and rear mounting bolt (arrowed) ...



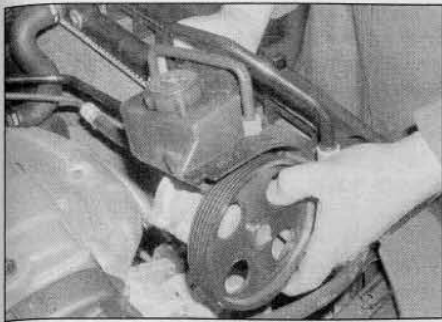

8.4c ... then move the power steering pump to one side – petrol engine shown

the weight of the pump by tying it to the vehicle body/engine to prevent any excess strain being placed on the hydraulic pipes/hoses. **Note:** There is no need to disconnect the pipes/hoses from the pump. Release the pipes/hoses from any necessary clips to prevent them being strained.

5 Depending on engine and equipment fitted, either undo the three bolts and remove the auxiliary drivebelt tensioner assembly, or undo the bolts and remove the auxiliary drivebelt idler pulley bracket.

6 Remove the rubber cover(s) from the alternator terminal(s), then unscrew the retaining nut(s) and disconnect the wiring from the rear of the alternator (see illustrations).

7 Unscrew the alternator mounting bolts and, where applicable, the bolt securing the adjuster bolt bracket to the alternator (see illustration). Note that on some models, the left-hand bolt(s) act as centralisers and incorporate a spacer and cone. To access the left-hand lower mounting bolt, unbolt the air conditioning compressor (where fitted) and move it to one side. **Do not** disconnect the refrigerant pipes.

8 Manoeuvre the alternator away from its mounting brackets and out from the engine compartment.

### Refitting

9 Refitting is a reversal of removal, tightening the left-hand (centraliser) bolts first, followed by the right-hand bolts. Refit and tension the auxiliary drivebelt as described in Chapter 1A or 1B.

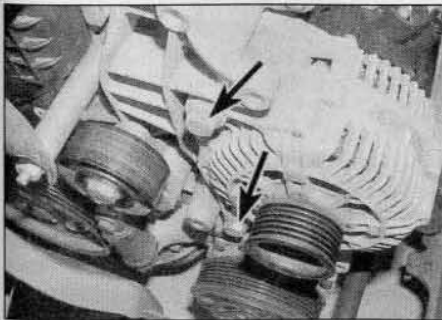

8.7 Alternator front mounting bolts (arrowed) – petrol engine shown

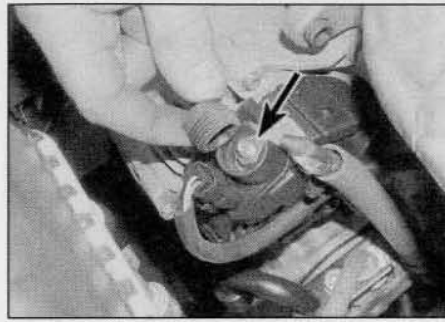

8.6a Remove the rubber cover then unscrew the nut (arrowed) ...

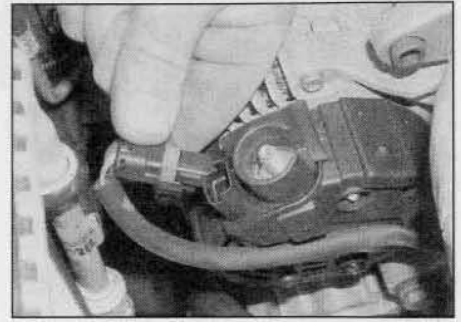

8.6b ... and disconnect the wiring from the alternator – petrol engine shown

## 9 Alternator – testing and overhaul

If the alternator is thought to be suspect, it should be removed from the vehicle and taken to an auto-electrician for testing. Most auto-electricians will be able to supply and fit brushes at a reasonable cost. However, check on the cost of repairs before proceeding as it may prove more economical to obtain a new or exchange alternator.

## 10 Starting system – testing

**Note:** Refer to the precautions given in 'Safety first!' and in Section 1 of this Chapter before starting work.

1 If the starter motor fails to operate when the ignition key is turned to the appropriate position, the following possible causes may be to blame.

- The engine immobiliser is faulty.
- The battery is faulty.
- The electrical connections between the switch, solenoid, battery and starter motor are somewhere failing to pass the necessary current from the battery through the starter to earth.
- The solenoid is faulty.
- The starter motor is mechanically or electrically defective.

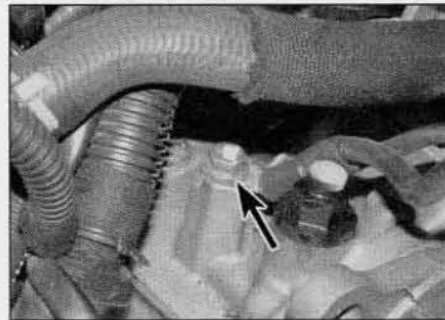

10.3 Engine/transmission earth strap connection (arrowed)

2 To check the battery, switch on the headlights. If they dim after a few seconds, this indicates that the battery is discharged – recharge (see Section 3) or renew the battery. If the headlights glow brightly, operate the ignition switch and observe the lights. If they dim, then this indicates that current is reaching the starter motor, therefore the fault must lie in the starter motor. If the lights continue to glow brightly (and no clicking sound can be heard from the starter motor solenoid), this indicates that there is a fault in the circuit or solenoid – see following paragraphs. If the starter motor turns slowly when operated, but the battery is in good condition, then this indicates that either the starter motor is faulty, or there is considerable resistance somewhere in the circuit.

3 If a fault in the circuit is suspected, disconnect the battery leads (including the earth connection to the body), the starter/solenoid wiring and the engine/transmission earth strap(s) – located on the transmission housing (see illustration). Thoroughly clean the connections and reconnect the leads and wiring, then use a voltmeter or test lamp to check that full battery voltage is available at the battery positive lead connection to the solenoid, and that the earth is sound. Smear petroleum jelly around the battery terminals to prevent corrosion – corroded connections are amongst the most frequent causes of electrical system faults.

4 If the battery and all connections are in good condition, check the circuit by disconnecting the ignition switch supply wire from the solenoid terminal. Connect a voltmeter or test lamp between the wire end and a good earth (such as the battery negative terminal), and check that the wire is live when the ignition switch is turned to the 'start' position. If it is, then the circuit is sound – if not the circuit wiring can be checked as described in Chapter 12.

5 The solenoid contacts can be checked by connecting a voltmeter or test lamp between the battery positive feed connection on the starter side of the solenoid, and earth. When the ignition switch is turned to the 'start' position, there should be a reading or lighted bulb, as applicable. If there is no reading or

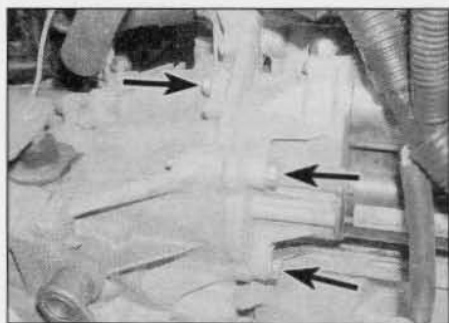

11.6 Starter motor mounting bolts (arrowed) – petrol engine shown

lighted bulb, the solenoid is faulty and should be renewed.

6 If the circuit and solenoid are proved sound, the fault must lie in the starter motor. In this event, it may be possible to have the starter motor overhauled by a specialist, but check on the cost of spares before proceeding, as it may prove more economical to obtain a new or exchange motor.

### 11 Starter motor – removal and refitting



#### Removal

1 Disconnect the battery negative terminal (refer to *Disconnecting the battery* in the Reference Chapter).

2 On 1.9 litre DW series diesel engines, release the clip in the centre of the engine cover and undo the retaining screw on the right-hand side. Lift off the engine cover. On 2.0 litre diesel engines, turn the four plastic fasteners through 90° and lift off the engine cover (see illustrations 8.3a to 8.3e).

3 So that access to the motor can be gained both from above and below, apply the handbrake then jack up the front of the vehicle and support it on axle stands (see *Jacking and vehicle support*). Release the screws and remove the engine undershield (where fitted).

4 Remove the air cleaner assembly and air

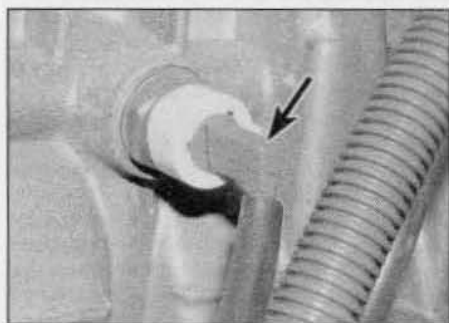

14.3 Disconnect the wiring connector (arrowed) from the oil pressure switch

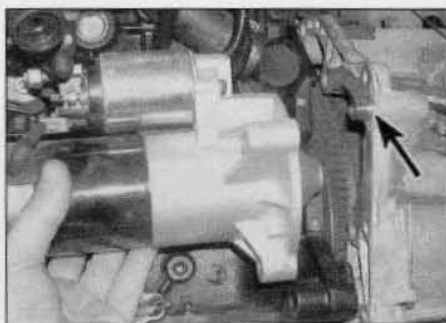

11.7 Remove the starter motor and recover the locating dowel (arrowed) – diesel engine shown

intake ducts as described in Chapter 4A or 4B.

5 Slacken and remove the two retaining nuts and disconnect the wiring from the starter motor solenoid. Recover the washers under the nuts.

6 Undo the three mounting bolts (two at the rear of the motor, and one which comes through from the top of the transmission housing), supporting the motor as the bolts are withdrawn (see illustration). Recover the washers from under the bolt heads and note the locations of any wiring or hose brackets secured by the bolts.

7 Manoeuvre the starter motor out from underneath the engine and recover the locating dowel(s) from the motor/transmission (as applicable) (see illustration).

#### Refitting

8 Refitting is a reversal of removal, ensuring that the locating dowel(s) are correctly positioned. Also make sure that any wiring or hose brackets are in place under the bolt heads as noted prior to removal.

### 12 Starter motor – testing and overhaul



If the starter motor is thought to be suspect, it should be removed from the vehicle and taken to an auto-electrician for testing. Most auto-electricians will be able to supply and fit

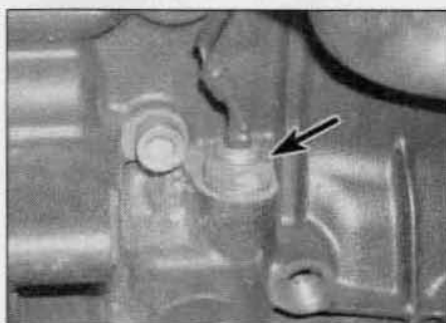

15.1 Oil level sensor (arrowed) – diesel engine shown

brushes at a reasonable cost. However, check on the cost of repairs before proceeding as it may prove more economical to obtain a new or exchange motor.

### 13 Ignition switch – removal and refitting

The ignition switch is integral with the steering column lock, and can be removed as described in Chapter 10.

### 14 Oil pressure warning light switch – removal and refitting



#### Removal

1 The switch is fitted at the front of the cylinder block, above the oil filter mounting or screwed into the oil filter housing. Note that on some models access to the switch may be improved if the vehicle is jacked up and supported on axle stands, and the engine undershield removed (where fitted), so that the switch can be reached from underneath (see *Jacking and vehicle support*).

2 Disconnect the battery negative terminal (refer to *Disconnecting the battery* in the Reference Chapter).

3 Remove the protective sleeve from the wiring plug (where applicable), then disconnect the wiring from the switch (see illustration).

4 Unscrew the switch from the cylinder block, and recover the sealing washer. Be prepared for oil spillage, and if the switch is to be left removed from the engine for any length of time, plug the hole in the cylinder block.

#### Refitting

5 Examine the sealing washer for signs of damage or deterioration and if necessary renew.

6 Refit the switch, complete with washer, and tighten it securely. Reconnect the wiring connector and reconnect the battery.

7 Lower the vehicle to the ground then check and, if necessary, top-up the engine oil as described in *Weekly checks*.

### 15 Oil level sensor – removal and refitting



1 On petrol engines the sensor is located on the front side of the cylinder block adjacent to the oil filter housing. On diesel engines, it is fitted to the rear of the cylinder block on the left-hand end (see illustration).

2 The removal and refitting procedure is as described for the oil pressure switch in Section 14. Access is most easily obtained from underneath the vehicle.







# Chapter 5 Part B:

## Ignition system – petrol models

### Contents

	Section number	Section number	
Ignition coil unit – removal, testing and refitting	3	Ignition timing – checking and adjustment	4
Ignition system – general information	1	Knock sensor – removal and refitting	5
Ignition system – testing	2	Spark plugs	See Chapter 1A
Ignition system check	See Chapter 1A		

### Degrees of difficulty

<b>Easy</b> , suitable for novice with little experience		<b>Fairly easy</b> , suitable for beginner with some experience		<b>Fairly difficult</b> , suitable for competent DIY mechanic		<b>Difficult</b> , suitable for experienced DIY mechanic		<b>Very difficult</b> , suitable for expert DIY or professional	
--	---	---	---	---	---	--	---	---	---

### Specifications

#### General

System type	Static (distributorless) ignition system controlled by engine management ECU
Firing order	1-3-4-2 (No 1 cylinder at transmission end)
Spark plugs	See Chapter 1A Specifications
Ignition timing	Controlled by engine management ECU

#### Torque wrench setting

	Nm	lbf ft
Knock sensor securing bolt	20	15

#### 1 Ignition system – general information

The ignition system is integrated with the fuel injection system, to form a combined engine management system under the control of one ECU (see Chapter 4A for further information).

The ignition side of the system is of the static (distributorless) type, consisting only of two twin-output ignition coils. On early models, the ignition coils are housed in a single unit, mounted on the left hand end of the cylinder head; four HT leads connect the coil output terminals to the spark plugs. On later models, the ignition coils are housed in a single unit, which is mounted directly above

the spark plugs – no HT leads are fitted.

Each ignition coil serves two cylinders each (one coil supplies cylinders 1 and 4, and the other cylinders 2 and 3).

Under the control of the ECU, the ignition coil operates on the 'wasted spark' principle. The spark plugs are fired in two pairs, twice for each complete cycle of the engine. One plug of each pair will fire on a compression stroke and one on an exhaust stroke; the spark on the exhaust stroke has no effect on the running of the engine and is therefore 'wasted'. The ECU uses inputs from various sensors to calculate the required ignition advance setting and coil charging time.

On certain models, a knock sensor is incorporated into the ignition system. The sensor is mounted on the cylinder block and prevents the engine 'pinking' under load. The sensor is sensitive to vibration and detects the

knocking which occurs when the engine starts to 'pink' (pre-ignite). The knock sensor sends an electrical signal to the ECU, which in turn retards the ignition advance setting until the 'pinking' ceases.

#### 2 Ignition system – testing



**Warning:** Due to the high voltages produced by the electronic ignition system, extreme care must be taken when working on the system with the ignition switched on. Persons with surgically-implanted cardiac pacemaker devices should keep well clear of the ignition circuits, components and test equipment.



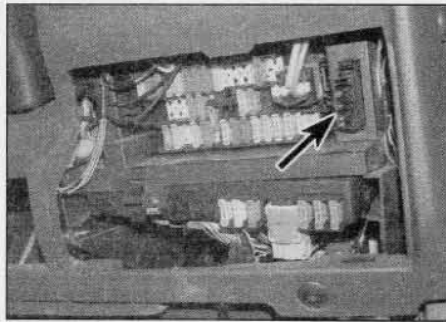

2.2 The diagnostic socket (arrowed) is located adjacent to the passenger's compartment fusebox

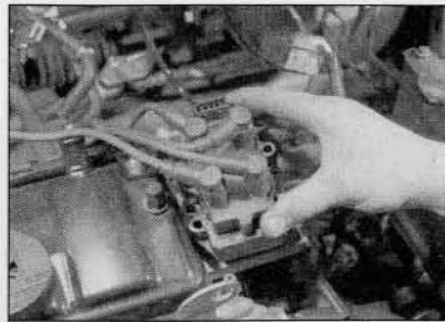

3.2 Disconnect the wiring connector from the HT coil

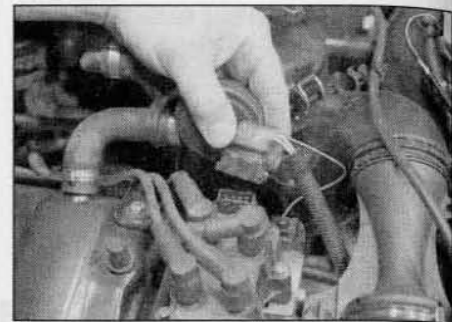

3.3 Disconnect the HT leads from the coil terminals

1 If a fault appears in the engine management system, first ensure that all the system wiring connectors are securely connected and free of corrosion. Ensure that the fault is not due to poor maintenance; ie, check that the air cleaner filter element is clean, the spark plugs are in good condition and correctly gapped, the cylinder compression pressures are correct and that the engine breather hoses are clear and undamaged, referring to Chapters 1A and 2A for further information.

2 If these checks fail to reveal the cause of the problem, the vehicle should be taken to a suitably-equipped Peugeot/Citroën dealer or engine management diagnostic specialist for testing. A diagnostic socket is located

adjacent to the passenger's compartment fusebox, to which a fault code reader or other suitable test equipment can be connected (see illustration). By using the code reader or test equipment, the engine management ECU (and the various other vehicle system ECUs) can be interrogated, and any stored fault codes can be retrieved. This will allow the fault to be quickly and simply traced, alleviating the need to test all the system components individually, which is a time-consuming operation that carries a risk of damaging the ECU.

3 The only ignition system checks which can be carried out by the home mechanic are those described in Chapter 1A relating to the spark plugs.

### 3 Ignition coil unit - removal, testing and refitting

#### Removal - 1.4 litre engines

##### Cylinder head mounted coil

- 1 The ignition HT coil is mounted on the left-hand end of the cylinder head.
- 2 Disconnect the battery negative terminal (refer to *Disconnecting the battery* in the Reference Chapter), then depress the retaining clip and disconnect the wiring connector from the HT coil (see illustration).
- 3 Make a note of the correct fitted positions of the HT leads then disconnect them from the coil terminals (see illustration).
- 4 Undo the four retaining screws securing the coil to its mounting bracket and remove it from the engine compartment (see illustration).

##### Spark plug mounted coil module

- 5 Disconnect the battery negative terminal (refer to *Disconnecting the battery* in the Reference Chapter).
- 6 Disconnect the engine breather hose at the quick-release connections on the air cleaner air intake duct, cylinder head cover and inlet manifold (see illustrations). Move the hose to one side.
- 7 Unplug the wiring connector from the top of the ignition coil unit (see illustration).

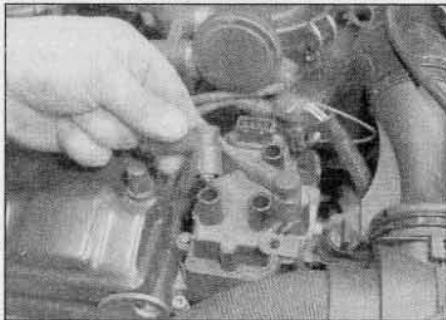

3.4 Undo the four retaining screws and remove the ignition HT coil from the mounting bracket

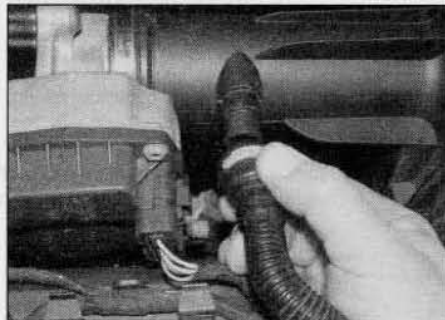

3.6a Disconnect the engine breather hose at the air cleaner air intake duct ...

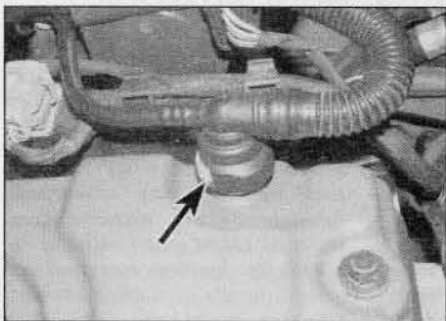

3.6b ... cylinder head cover (arrowed) ...

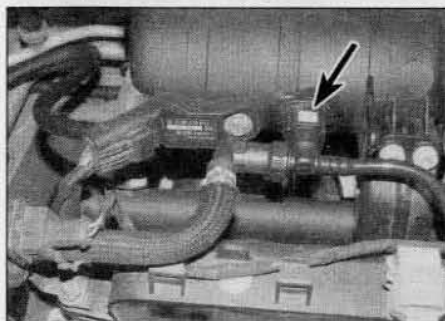

3.6c ... and inlet manifold (arrowed)

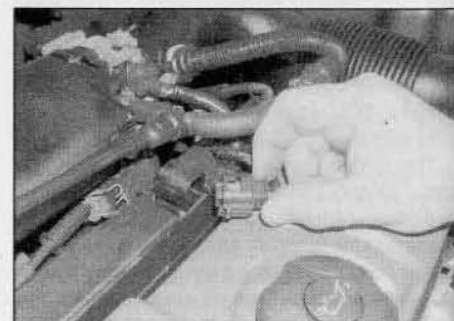

3.7 Unplug the wiring connector from the top of the ignition coil unit



3.8a Remove radio suppresser from the right-hand end of the coil unit . . .

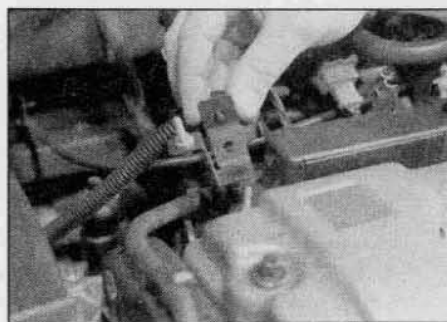

3.8b . . . together with its mounting bracket

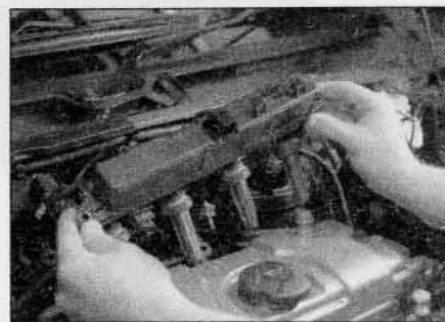

3.10 Lift the ignition coil unit from the mounting studs

8 Where applicable, unscrew the securing nut and remove the radio suppresser from the right-hand end of the coil unit, together with its mounting bracket (see illustrations).

9 Undo the nut securing each end of the ignition coil unit to the mounting studs. Note that it is quite likely that the stud will be released with the nut.

10 Lift the ignition coil unit upwards off the mounting studs and at the same time carefully ease the HT extension pillars away from the tops of the spark plugs. Lift the unit off the plugs and withdraw it from the engine (see illustration).

**Removal - 1.6 litre engines**

11 Undo the six screws and remove the plastic coil unit cover from the top of the engine between the two camshaft covers.

12 Disconnect the wiring plug from the left-hand end of the ignition coil unit (see illustration).

13 Depress the clips and remove the two breather pipes from between the camshaft covers (see illustration).

14 Undo the four mounting screws securing the coil unit (see illustration).

15 Lift the ignition coil unit upwards and at the same time carefully ease the HT extension pillars away from the tops of the spark plugs.

Lift the unit off the plugs and withdraw it from the engine.

**Testing**

16 The circuitry arrangement of the ignition coil unit on these engines is such that testing of an individual coil in isolation from the remainder of the engine management system is unlikely to prove effective in diagnosing a particular fault. Should there be any reason to suspect a faulty individual coil, the engine management system should be tested by a Peugeot/Citroën dealer or specialist using diagnostic test equipment (see Section 2).

**Refitting**

17 Refitting is a reversal of the relevant removal procedure ensuring the wiring connectors are securely reconnected.

**4 Ignition timing - checking and adjustment**

1 There are no timing marks on the flywheel or crankshaft pulley. The timing is constantly being monitored and adjusted by the engine management ECU, and nominal values cannot be given. Therefore, it is not possible

for the home mechanic to check the ignition timing.

2 The only way in which the ignition timing can be checked is using special electronic test equipment, connected to the engine management system diagnostic connector (refer to Chapter 4A for further information).

**5 Knock sensor - removal and refitting**

**Removal**

1 The knock sensor is screwed into the rear face of the cylinder block.

2 Firmly apply the handbrake, then jack up the front of the vehicle and support it securely on axle stands (see *Jacking and vehicle support*).

3 Trace the wiring back from the sensor to its wiring connector, and disconnect it from the main loom.

4 Undo the sensor securing bolt and remove the sensor from the cylinder block.

**Refitting**

5 Refitting is a reversal of the removal procedure, ensuring that the sensor securing bolt is tightened to the specified torque.

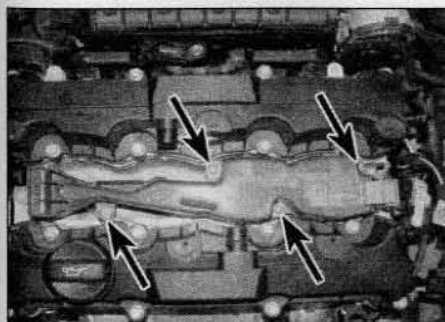

3.12 Disconnect the wiring plug from the HT coils (arrowed)

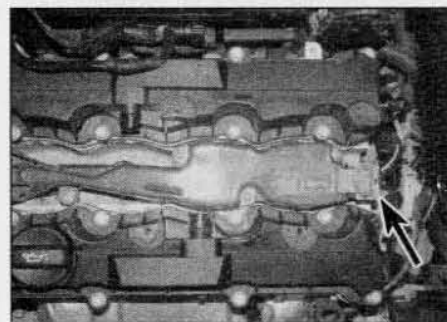

3.13 Depress the clips and disconnect the breather pipes

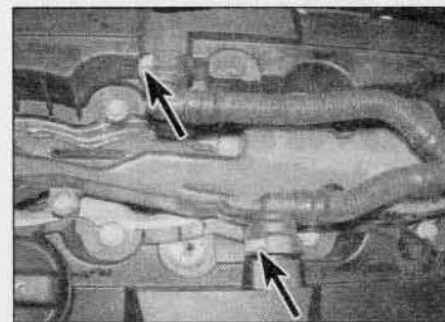

3.14 Undo the coil unit retaining screws



Figure 1: [Faint text describing the specimen in Figure 1]

[Faint text paragraph describing the specimen in Figure 1]

[Faint text paragraph describing the specimen in Figure 1]

[Faint text paragraph describing the specimen in Figure 1]

[Faint text paragraph describing the specimen in Figure 1]

[Faint text paragraph describing the specimen in Figure 1]

[Faint text paragraph describing the specimen in Figure 1]

[Faint text paragraph describing the specimen in Figure 1]



Figure 2: [Faint text describing the specimen in Figure 2]

[Faint text paragraph describing the specimen in Figure 2]

[Faint text paragraph describing the specimen in Figure 2]

[Faint text paragraph describing the specimen in Figure 2]

[Faint text paragraph describing the specimen in Figure 2]

[Faint text paragraph describing the specimen in Figure 2]

[Faint text paragraph describing the specimen in Figure 2]

[Faint text paragraph describing the specimen in Figure 2]

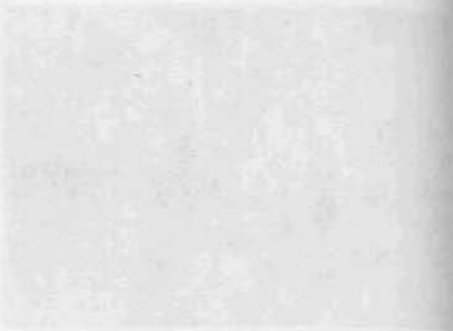

Figure 3: [Faint text describing the specimen in Figure 3]

[Faint text paragraph describing the specimen in Figure 3]

[Faint text paragraph describing the specimen in Figure 3]

[Faint text paragraph describing the specimen in Figure 3]

[Faint text paragraph describing the specimen in Figure 3]

[Faint text paragraph describing the specimen in Figure 3]

[Faint text paragraph describing the specimen in Figure 3]

[Faint text paragraph describing the specimen in Figure 3]



# Chapter 5 Part C:

## Pre/post-heating system – diesel models

### Contents

	Section number		Section number
Glow plugs – removal, inspection and refitting .....	2	Preheating system control unit – removal and refitting .....	3
Preheating system – description and testing .....	1		

### Degrees of difficulty

**Easy**, suitable for novice with little experience



**Fairly easy**, suitable for beginner with some experience



**Fairly difficult**, suitable for competent DIY mechanic



**Difficult**, suitable for experienced DIY mechanic



**Very difficult**, suitable for expert DIY or professional



### Specifications

#### Glow plugs

Resistance (typical) ..... Less than 1 ohm

#### Torque wrench setting

	Nm	lbf ft
Glow plugs .....	22	16

#### 1 Preheating system – description and testing

##### Description

**1** Each swirl chamber has a heater plug (commonly called a glow plug) screwed into it. The plugs are electrically-operated before and during start-up when the engine is cold.

**2** The electrical feed to the glow plugs is controlled by the preheating system control unit. With the exception of later 1.9 litre (WJY) engines and all 2.0 litre engines, the control unit operates using signals received from the coolant temperature sensor and accelerator switch on the injection pump. On later 1.9 litre (WJY) engines and all 2.0 litre engines, the control unit is operated by the injection system ECU (see Chapter 4C).

**3** On certain models, the glow plugs provide a 'post-heating' function, whereby the glow plugs remain switched on for a period after the engine has started. Once the starter has been switched off, the glow plugs begin a timed 'post-heating' cycle. Post-heating only

takes place if the engine is cold (coolant temperature below 60° on 1.8 and 1.9 litre engines, and below 20° on 2.0 litre engines) and the supply to the glow plugs will be interrupted if the engine is placed under load.

**4** A warning light in the instrument panel tells the driver that preheating is taking place. When the light goes out, the engine is ready to be started. The voltage supply to the glow plugs continues for several seconds after the light goes out. If no attempt is made to start, the timer then cuts off the supply, in order to avoid draining the battery and overheating the glow plugs.

##### Testing

###### 1.8 and 1.9 litre engines

**5** If the system malfunctions, testing is ultimately by substitution of known good units, but some preliminary checks may be made as follows.

**6** Where applicable, release the fasteners from the right-hand side and top of the engine cover, then lift off the cover, taking care not to lose its mounting rubbers.

**7** Connect a voltmeter or 12 volt test lamp between the glow plug supply cable and earth

(engine or vehicle metal). Make sure that the live connection is kept clear of the engine and bodywork.

**8** Have an assistant switch on the ignition, and check that voltage is applied to the glow plugs. Note the time for which the warning light is lit, and the total time for which voltage is applied before the system cuts out. Switch off the ignition.

**9** At a coolant temperature of 20°C, typical times noted should be 5 or 6 seconds for warning light operation, followed by a further 10 seconds supply after the light goes out. Warning light time will increase with lower temperatures and decrease with higher temperatures.

**10** If there is no supply at all, the control unit or associated wiring is at fault.

**11** To locate a defective glow plug, on 1.9 litre models with the D9B engine remove the air distribution housing. If necessary, also remove the inlet duct, and disconnect the breather hose from the engine oil filler tube. Refer to Chapter 4B for further information. Disconnect the main supply cable and the interconnecting wire or strap from the top of the glow plugs. Be careful not to drop the nuts and washers.

12 Use a continuity tester, or a 12 volt test lamp connected to the battery positive terminal, to check for continuity between each glow plug terminal and earth. The resistance of a glow plug in good condition is very low (less than 1 ohm), so if the test lamp does not light or the continuity tester shows a high resistance, the glow plug is certainly defective.

13 If an ammeter is available, the current draw of each glow plug can be checked. After an initial surge of 15 to 20 amps, each plug should draw 12 amps. Any plug which draws much more or less than this is probably defective.

14 As a final check, the glow plugs can be removed and inspected as described in the following Section.

**2.0 litre engines**

15 The system can be checked as described in paragraphs 7 to 14. However testing will be difficult due to the temperatures at which the preheating system functions; at coolant temperatures above 0°C, preheating is virtually unnecessary. Approximate times for preheating duration are as follows:

**Coolant**

temperature	Preheating time
-30°C	20 seconds
-10°C	5 seconds
0°C	0.5 seconds
18°C	No preheating necessary

**2 Glow plugs – removal, inspection and refitting**

**Removal**

**Caution:** If the preheating system has just been energised, or if the engine has been running, the glow plugs will be very hot.

1 Disconnect the battery negative terminal (refer to *Disconnecting the battery* in the Reference Chapter).

2 On 1.9 litre models with the D9B engine remove the air distribution housing. If necessary, also remove the inlet duct, and disconnect the breather hose from the engine oil filler tube. Refer to Chapter 4B for further information.

3 On 1.9 litre models with an engine cover, release the fasteners from the right-hand side and top of the engine cover, then lift off the cover, taking care not to lose its mounting rubbers. On 2.0 litre models, release the fasteners (rotate them through 90° to release them) and remove the engine cover.

4 Unscrew the nut from the relevant glow plug terminal(s), and recover the washer(s) (see illustration). Note that the main supply cable is connected to No 1 cylinder glow plug and an inter-connecting wire is fitted between the four plugs.

5 Where applicable, carefully move any

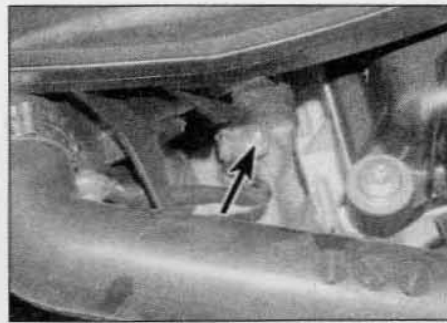

2.4 Unscrew the nut (arrowed) and disconnect the wiring from the glow plug terminal (later 1.9 litre engine shown)

obstructing pipes or wires to one side to enable access to the relevant glow plug(s).

6 Unscrew the glow plug(s) and remove from the cylinder head (see illustration).

**Inspection**

7 Inspect each glow plug for physical damage. Burnt or eroded glow plug tips can be caused by a bad injector spray pattern. Have the injectors checked if this sort of damage is found.

8 If the glow plugs are in good physical condition, check them electrically using a 12 volt test lamp or continuity tester as described in the previous Section.

9 The glow plugs can be energised by applying 12 volts to them to verify that they heat up evenly and in the required time. Observe the following precautions.

- a) Support the glow plug by clamping it carefully in a vice or self-locking pliers. Remember it will become red-hot.
- b) Make sure that the power supply or test lead incorporates a fuse or overload trip to protect against damage from a short-circuit.
- c) After testing, allow the glow plug to cool for several minutes before attempting to handle it.

10 A glow plug in good condition will start to glow red at the tip after drawing current for 5 seconds or so. Any plug which takes much longer to start glowing, or which starts glowing in the middle instead of at the tip, is defective.

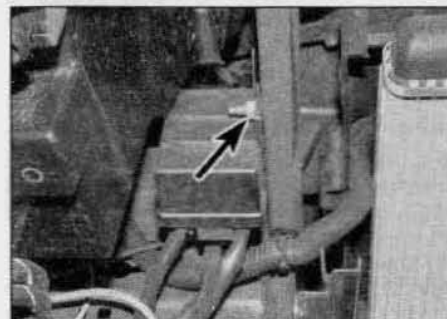

3.3 Unscrew the retaining nut (arrowed) securing the preheating system unit to its mounting

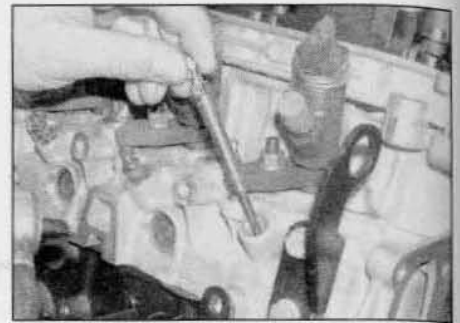

2.6 Unscrew the glow plug(s) and remove them from the cylinder head (2.0 litre engine shown with fuel rail removed)

**Refitting**

11 Refit by reversing the removal operations. Apply a smear of copper-based anti-seize compound to the plug threads and tighten the glow plugs to the specified torque. Do not overtighten, as this can damage the glow plug element.

**3 Preheating system control unit – removal and refitting**

**Removal**

1 The unit is located on the left-hand side of the engine compartment on the inner wing panel, or on the front body panel adjacent to the radiator.

2 Disconnect the battery negative terminal (refer to *Disconnecting the battery* in the Reference Chapter).

3 Unscrew the retaining nut securing the unit to its mounting (see illustration).

4 Disconnect the wiring connector from the base of the unit then unscrew the two retaining nuts and free the main feed and supply wires from the unit (see illustration). Remove the unit from the engine compartment.

**Refitting**

5 Refitting is a reversal of removal, ensuring that the wiring connectors are correctly connected.

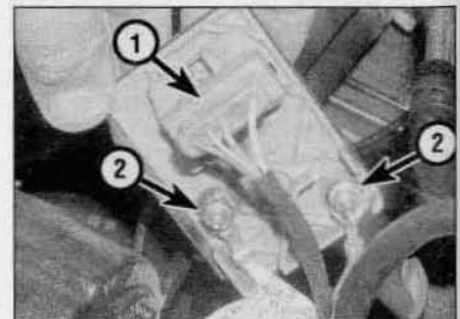

3.4 Disconnect the wiring connector (1) then unscrew the nuts (2) and disconnect the feed and supply wires from the control unit

# Chapter 6

## Clutch

### Contents

	Section number	Section number	
Clutch assembly – removal, inspection and refitting .....	4	Clutch release mechanism – removal, inspection and refitting .....	5
Clutch cable – removal and refitting .....	2	General checks .....	See Chapter 1A or 1B
Clutch pedal – removal and refitting .....	3	General information .....	1

### Degrees of difficulty

**Easy**, suitable for novice with little experience



**Fairly easy**, suitable for beginner with some experience



**Fairly difficult**, suitable for competent DIY mechanic



**Difficult**, suitable for experienced DIY mechanic



**Very difficult**, suitable for expert DIY or professional



### Specifications

Type .....	Single dry plate with diaphragm spring, cable-operated	
Friction disc diameter .....	200 mm	
<b>Torque wrench settings</b>	<b>Nm</b>	<b>lbf ft</b>
Pressure plate retaining bolts:		
Petrol models .....	15	11
Diesel models .....	20	15

#### 1 General information

The clutch consists of a friction disc, a pressure plate assembly, a release bearing and the release mechanism; all of these components are contained in the large cast-aluminium alloy bellhousing, sandwiched between the engine and the transmission. The release mechanism is mechanical, being operated by a cable.

The friction disc is fitted between the engine flywheel and the clutch pressure plate, and is allowed to slide on the transmission input shaft splines.

The pressure plate assembly is bolted to the engine flywheel. When the engine is running, drive is transmitted from the

crankshaft, via the flywheel, to the friction disc (these components being clamped securely together by the pressure plate assembly) and from the friction disc to the transmission input shaft.

To interrupt the drive, the spring pressure must be relaxed. At the transmission end of the clutch cable, the outer cable is retained by a fixed mounting bracket, and the inner cable is attached to the release fork lever. Depressing the clutch pedal pulls the control cable inner wire, and this rotates the release fork by acting on the lever at the fork's upper end. The release fork then presses the release bearing against the pressure plate spring fingers. This causes the springs to deform and releases the clamping force on the pressure plate.

On all models the clutch cable has an automatic adjuster built into the cable, and no manual adjustment is required.

#### 2 Clutch cable – removal and refitting

##### Removal

**1** The clutch cable attachment at the transmission varies according to the transmission type fitted. On MA5 and BE3/5 transmissions, the outer cable is secured to the engine/transmission left-hand mounting bracket and the inner cable end fitting is connected to the release fork lever on the top of the transmission. On BE4/5 transmissions, the outer cable is attached to a support bracket and the inner cable end fitting is connected to the release fork on the forward facing side of the transmission. Refer to Chapter 7 for transmission type identification.





**2.3a** On MA5 and BE3/5 transmissions, release the clutch inner cable end fitting from the release fork lever . . .

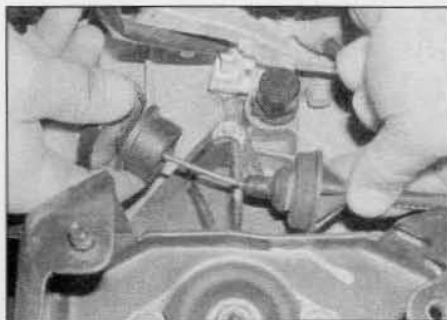

**2.3b** . . . then depress the tabs and release the outer cable from the transmission mounting bracket

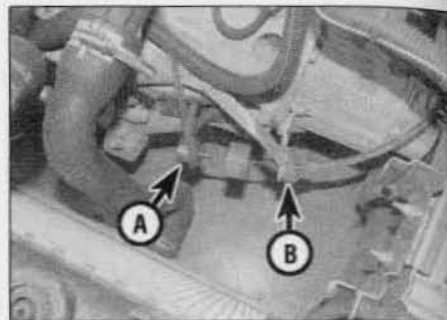

**2.3c** On BE4/5 transmissions, release the clutch inner cable end fitting (A) from the release fork and the outer cable (B) from the support bracket

**2** Remove the battery, battery tray and mounting plate as described in Chapter 5A. Depending on model and clearance available, remove any remaining air cleaner and air intake duct components as described in the relevant Part of Chapter 4, to gain access to the cable run over the top of the transmission.

**3** Working in the engine compartment, release the inner cable end fitting from the release fork/lever, then depress the tabs and unclip the outer cable end fitting from the transmission bracket (see illustrations).

**4** Working inside the car, remove the fusebox cover and the under cover from beneath the fascia on the driver's side. Note that access to the clutch pedal inside the car is still very limited and it is recommended that the fascia be removed first, although this is a major operation.

**5** Reach up and release the retaining clip then unhook the inner cable from the upper end of the clutch pedal.

**6** Return to the engine compartment, then release the cable guide from the bulkhead and withdraw the cable forwards, releasing it from any relevant retaining clips and guides.

**7** Firmly apply the handbrake, then jack up the front of the car and support it securely on axle stands (see *Jacking and vehicle support*). Where fitted, remove the engine undertray.

**8** Release the cable from the retaining clips on the subframe and remove it from the car, noting its correct routing.

**9** Examine the cable, looking for worn end fittings or a damaged outer casing, and for signs of fraying of the inner cable. Check the cable's operation; the inner cable should move smoothly and easily through the outer casing. Remember that a cable that appears serviceable when tested off the car may well be much heavier in operation when in its working position. Renew the cable if it shows signs of excessive wear or any damage.

### Refitting

**10** Apply a thin smear of multi-purpose grease to the cable end fittings, then pass the cable through the engine compartment bulkhead.

**11** Hold the clutch pedal in its raised position by wedging a suitable tool beneath it.

**12** Guide the end of the cable onto the pedal and secure with the retaining clip.

**13** From within the engine compartment, lubricate the cable guide and locate it into position on the bulkhead.

**14** Ensuring that the cable is correctly routed, secure the cable to the subframe, and engine compartment retaining clips then lay the cable over the transmission.

**15** Attach the outer cable to the transmission bracket and connect the inner cable to the clutch release fork/lever. Ensure that the cable spacers and washers are correctly positioned against the lever/support bracket.

**16** Depress the clutch pedal two or three times to settle the cable and operate the automatic adjuster.

**17** Refit the battery mounting plate, battery tray and battery, referring to Chapter 5A if necessary.

**18** Refit the air cleaner and air intake duct components as described in the relevant Part of Chapter 4.

**19** Refit the fusebox cover and the under cover beneath the fascia. Where applicable, refit the engine undertray then lower the car to the ground.

### 3 Clutch pedal - removal and refitting

#### Removal

**1** Remove the battery, battery tray and mounting plate as described in Chapter 5A. Depending on model and clearance available, remove any remaining air cleaner and air intake duct components as described in the relevant Part of Chapter 4, to gain access to the clutch cable run over the top of the transmission.

**2** Working in the engine compartment, release the inner cable end fitting from the release fork/lever, with reference to Section 2.

**3** Working inside the car, remove the fusebox

cover and the under cover from beneath the fascia on the driver's side. Note that access to the clutch pedal inside the car is still very limited and it is recommended that the fascia be removed first, although this is a major operation.

**4** Reach up and release the retaining clip then unhook the inner cable from the upper end of the clutch pedal.

**5** Detach the clutch pedal helper spring end piece and release the helper spring from the pedal.

**6** Undo the nut from the clutch pedal pivot bolt and withdraw the bolt.

**7** Remove the clutch pedal from the pedal bracket and stop-plate. Recover the bush from the pedal pivot.

**8** Check the condition of the pedal, pivot bush and helper spring assembly and renew any components as necessary.

#### Refitting

**9** Lubricate the pedal pivot bolt with multi-purpose grease, then locate the pedal in the bracket and insert the pivot bolt. Refit the pivot bolt nut but do not fully tighten it at this stage.

**10** Reconnect the helper spring to the pedal.

**11** Raise the pedal fully and guide the end of the cable onto the pedal. Secure the cable with the retaining clip.

**12** Reconnect the clutch inner cable end fitting to the release fork/lever.

**13** Slacken the nut and bolt securing the pedal stop-plate to the pedal bracket.

**14** Using a lever, raise the stop-plate fully so that there is a considerable amount of free play at the pedal.

**15** Lower the stop-plate until there is between 1.0 and 3.0 mm free play at the pedal. Hold the stop-plate in this position and tighten the retaining nut and bolt and the pedal pivot bolt nut.

**16** Depress the pedal two or three times and check the operation of the cable and clutch release mechanism.

**17** Refit the remaining components removed for access.

#### 4 Clutch assembly – removal, inspection and refitting

**Note:** Although some friction materials may no longer contain asbestos, it is safest to assume they do, and to take precautions accordingly.



**Warning:** Dust created by clutch wear and deposited on the clutch components may contain asbestos, which is a health hazard. **DON'T** blow it out with compressed air, nor inhale any of it. **DO NOT** use petrol or petroleum-based solvents to clean off the dust. Brake system cleaner or methylated spirit should be used to flush the dust into a suitable receptacle. After the clutch components are wiped clean with rags, dispose of the contaminated rags and cleaner in a sealed, marked container.

#### Removal

1 Unless the complete engine/transmission is to be removed from the car and separated for major overhaul (see the relevant Part of Chapter 2), the clutch can be reached by removing the transmission as described in Chapter 7.

2 Before disturbing the clutch, use chalk or a marker pen to mark the relationship of the pressure plate assembly to the flywheel.

3 Working in a diagonal sequence, slacken the pressure plate bolts by half a turn at a time, until spring pressure is released and the bolts can be unscrewed by hand.

4 Prise the pressure plate assembly off its locating dowels, and collect the friction disc, noting which way round the disc is fitted (see illustrations).

#### Inspection

**Note:** Due to the amount of work necessary to remove and refit clutch components, it is considered good practice to renew the clutch friction disc, pressure plate assembly and release bearing as a matched set, even if only one of these is worn enough to require renewal. It is worth considering the renewal of the clutch components on a preventive basis if the engine and/or transmission have been removed for some other reason.

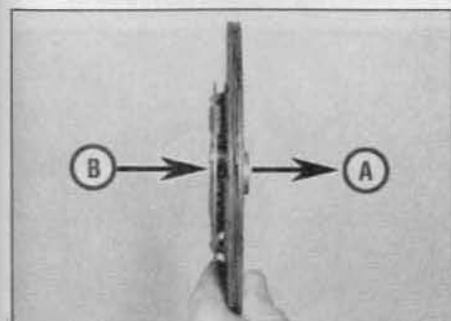

4.14 Fit the friction disc so that its spring hub assembly (B) faces away from the flywheel side (A)

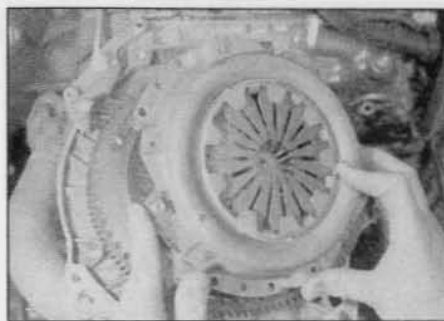

4.4a Free the pressure plate from its locating dowels . . .

5 Remove the clutch assembly.

6 When cleaning clutch components, read first the warning at the beginning of this Section; remove dust using a clean, dry cloth, and working in a well-ventilated atmosphere.

7 Check the friction disc facings for signs of wear, damage or oil contamination. If the friction material is cracked, burnt, scored or damaged, or if it is contaminated with oil or grease (shown by shiny black patches), the friction disc must be renewed.

8 If the friction material is still serviceable, check that the centre boss splines are unworn, that the torsion springs are in good condition and securely fastened, and that all the rivets are tight. If any wear or damage is found, the friction disc must be renewed.

9 If the friction material is fouled with oil, this must be due to an oil leak from the crankshaft left-hand oil seal, from the sump-to-cylinder block joint, or from the transmission input shaft. Renew the seal or repair the joint, as appropriate, as described in the relevant Part of Chapter 2 or 7, before installing the new friction disc.

10 Check the pressure plate assembly for obvious signs of wear or damage; shake it to check for loose rivets or worn or damaged fulcrum rings, and check that the drive straps securing the pressure plate to the cover do not show signs (such as a deep yellow or blue discoloration) of overheating. If the diaphragm spring is worn or damaged, or if its pressure is in any way suspect, the pressure plate assembly should be renewed.

11 Examine the machined bearing surfaces of the pressure plate and of the flywheel; they

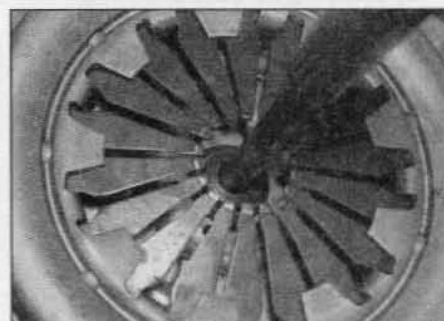

4.17 Using a clutch-aligning tool to centralise the friction disc



4.4b . . . then remove the friction disc, noting which way round it is fitted

should be clean, completely flat, and free from scratches or scoring. If either is discoloured from excessive heat, or shows signs of cracks, it should be renewed – although minor damage of this nature can sometimes be polished away using emery paper.

12 Check that the release bearing contact surface rotates smoothly and easily, with no sign of noise or roughness. Also check that the surface itself is smooth and unworn, with no signs of cracks, pitting or scoring. If there is any doubt about its condition, the bearing must be renewed.

#### Refitting

13 On reassembly, ensure that the bearing surfaces of the flywheel and pressure plate are completely clean, smooth, and free from oil or grease. Use solvent to remove any protective grease from new components.

14 Fit the friction disc so that its spring hub assembly faces away from the flywheel; there may be a marking showing which way round the disc is to be refitted (see illustration).

15 Refit the pressure plate assembly, aligning the marks made on dismantling (if the original pressure plate is re-used), and locating the pressure plate on its three locating dowels. Fit the pressure plate bolts, but tighten them only finger-tight, so that the friction disc can still be moved.

16 The friction disc must now be centralised, so that when the transmission is refitted, its input shaft will pass through the splines at the centre of the friction disc.

17 Centralisation can be achieved by passing a screwdriver or other long bar through the friction disc and into the hole in the crankshaft; the friction disc can then be moved around until it is centred on the crankshaft hole. Alternatively, a clutch aligning tool can be used to eliminate the guesswork; these can be obtained from most accessory shops (see illustration).

**HAYNES**  
**HINT**

A home-made aligning tool can be fabricated from a length of metal rod or wooden dowel which fits closely inside the crankshaft hole, and has insulating tape wound around it to match the diameter of the friction disc splined hole.





**5.3 Unhook the release bearing from the fork, and slide it off the input shaft – MA5 and BE3/5 transmissions**



**5.4a Drive out the roll-pin using a suitable punch ...**



**5.4b ... and remove the release lever from the top of the release fork shaft – MA5 and BE3/5 transmissions**

**18** When the friction disc is centralised, tighten the pressure plate bolts evenly and in a diagonal sequence to the specified torque setting.

**19** Apply a thin smear of molybdenum disulphide grease (Peugeot/Citroën recommend the use of Molykote BR2 Plus – available from your dealer) to the splines of the friction disc and the transmission input shaft, and also to the release bearing bore and release fork shaft.

**20** Refit the transmission as described in Chapter 7.

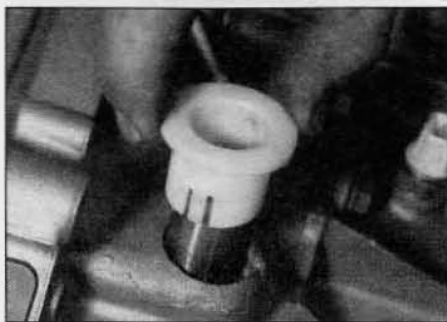

**5.5a Unclip the upper bush from the transmission housing and slide it off the shaft ...**

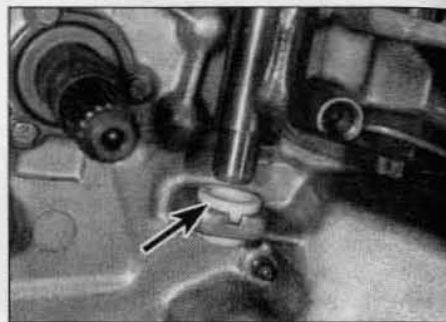

**5.5b ... then free the shaft from its lower bush (arrowed) and manoeuvre it out of position – MA5 and BE3/5 transmissions**

## 5 Clutch release mechanism – removal, inspection and refitting



**Note:** Refer to the warning concerning the dangers of asbestos dust at the beginning of Section 4.

### Removal

**1** Unless the complete engine/transmission is to be removed from the car and separated for major overhaul (see the relevant Part of Chapter 2), the clutch release mechanism can be reached by removing the transmission only, as described in Chapter 7.

**2** Different release mechanisms are fitted, depending on transmission type. Refer to Chapter 7 for transmission type identification, then proceed as follows under the relevant sub-heading.

### MA5 and BE3/5 transmissions

**3** Unhook the release bearing from the fork, and slide it off the input shaft guide tube (see illustration).

**4** The release lever must now be removed from the top of the release fork shaft. This is done in one of two ways, depending on transmission type and year of manufacture. Observe the method of attachment of the release lever to the release fork shaft and proceed as follows according to type:

a) *If the release lever is secured to the shaft by a roll-pin, drive out the roll-pin using a suitable punch, and remove the release lever from the top of the release fork shaft (see illustrations). Obtain a new roll-pin for refitting.*

b) *If the release lever is secured to the shaft by a retaining pin with a protruding*

*threaded end, screw a nut onto the threaded end of the retaining pin. Tighten the nut to draw the pin from the lever then remove the release lever from the top of the release fork shaft. Obtain a new retaining pin for refitting.*

**5** Depress the retaining tabs, then free the upper bush from the housing and slide it off the release fork shaft. Disengage the shaft from its lower bush, and manoeuvre it out from the transmission (see illustrations). The lower pivot bush can then be removed from the transmission housing.

### BE4/5 transmissions

**6** Squeeze together the tabs of the retaining clip and pull the release fork off the pivot ball-stud. Recover the shim where fitted. The mounting stud unscrews from the transmission housing (see illustrations).

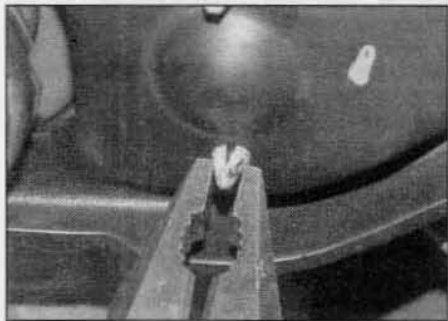

**5.6a Squeeze the tabs of the retaining clip together and remove the release fork ...**

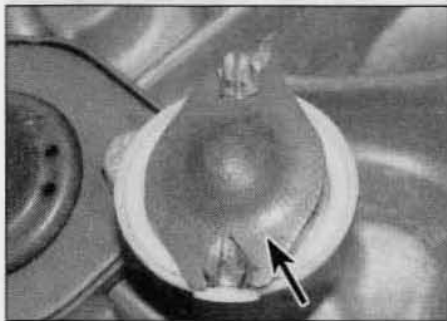

**5.6b ... recover the shim (arrowed) ...**



**5.6c ... then unscrew the pivot ball-stud – BE4/5 transmissions**





5.7 Disengage the release bearing from the release fork – BE4/5 transmissions

7 Slide the release bearing off the input shaft guide tube and disengage the arms of the release fork (see illustration).

### Inspection

8 Check the release mechanism, renewing any component which is worn or damaged. Carefully check all bearing surfaces and points of contact.

9 When checking the release bearing itself, note that it is often considered worthwhile to renew it as a matter of course. Check that the contact surface rotates smoothly and easily, with no sign of noise or roughness, and that the surface itself is smooth and unworn, with no signs of cracks, pitting or scoring. If there is any doubt about its condition, the bearing must be renewed.

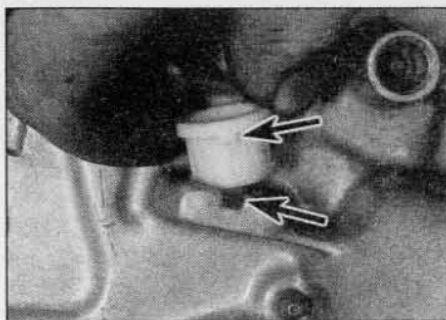

5.11 Ensure that the lower bush lug is correctly located in the transmission housing – MA5 and BE3/5 transmissions

### Refitting

#### MA5 and BE3/5 transmissions

10 Apply a smear of molybdenum disulphide grease to the shaft pivot bushes and the contact surfaces of the release fork.

11 Locate the lower pivot bush in the transmission, ensuring it is securely retained by its locating tangs, and refit the release fork shaft (see illustration). Slide the upper bush down the shaft, and clip it into position in the transmission housing.

12 Refit the release lever to the shaft. Align the lever with the shaft hole, and secure it in position by tapping a new roll-pin or retaining pin fully into position. Slide the release bearing onto the input shaft guide tube, and engage it with the release fork.

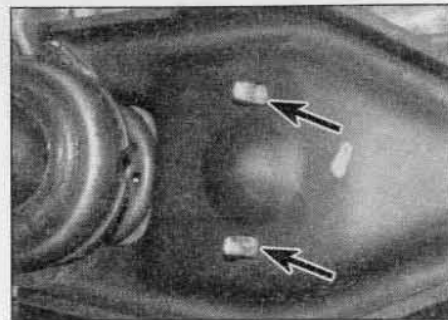

5.17 Ensure the retaining tabs (arrowed) engage correctly with the release fork – BE4/5 transmissions

13 Refit the transmission as described in Chapter 7.

#### BE4/5 transmissions

14 Apply a smear of molybdenum disulphide grease to the pivot ball-stud.

15 Insert the outer end of the release fork through the rubber boot in the side of the transmission bellhousing.

16 Engage the arms of the release fork with the release bearing collar, then slide the release bearing onto the input shaft guide tube.

17 Position the shim over the tabs of the pivot ball-stud clip, then push the fork over the stud, ensuring the tabs of the retaining clip engage correctly with the fork (see illustration).

18 Refit the transmission as described in Chapter 7.



Fig. 1. Micrograph showing a textured surface, likely a biological or material specimen.

Micrograph showing a textured surface, likely a biological or material specimen. The image displays a granular or fibrous structure with varying particle sizes and orientations, characteristic of a biological tissue or a synthetic material under microscopic examination.

Micrograph showing a textured surface, likely a biological or material specimen. This section provides a detailed view of the surface morphology, highlighting the irregular shapes and interconnected nature of the particles, which may be indicative of a specific biological process or material property.



Fig. 2. Micrograph showing a textured surface, likely a biological or material specimen.



Fig. 3. Micrograph showing a textured surface, likely a biological or material specimen.

Micrograph showing a textured surface, likely a biological or material specimen. The image shows a dense arrangement of small, dark, irregularly shaped particles, possibly representing a specific cellular component or a material's microstructure.

Micrograph showing a textured surface, likely a biological or material specimen. This micrograph highlights the intricate details of the surface texture, showing a complex network of fibers or granules that form a porous or interconnected structure.



Fig. 4. Micrograph showing a textured surface, likely a biological or material specimen.

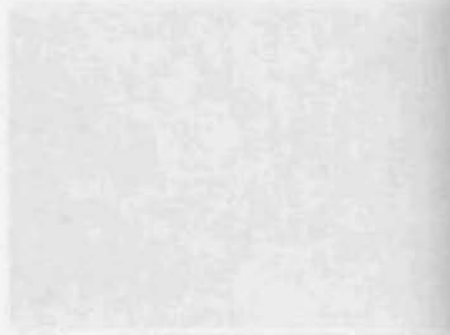

Fig. 5. Micrograph showing a textured surface, likely a biological or material specimen.

Micrograph showing a textured surface, likely a biological or material specimen. The image displays a highly textured surface with a mix of large and small particles, suggesting a heterogeneous material or biological structure.

Micrograph showing a textured surface, likely a biological or material specimen. This section shows a surface with a distinct, somewhat regular pattern of particles, which could be related to a specific biological organization or material synthesis process.



Fig. 6. Micrograph showing a textured surface, likely a biological or material specimen.





# Chapter 7

## Manual transmission

### Contents

	Section number		Section number
Gearchange linkage – removal and refitting .....	3	Manual transmission overhaul – general information .....	8
General information .....	1	Oil seals – renewal .....	4
Manual transmission – draining and refilling .....	2	Reversing light switch – testing, removal and refitting .....	5
Manual transmission – removal and refitting .....	7	Speedometer drive – removal and refitting .....	6
Manual transmission oil level check .....	See Chapter 1A or 1B		

### Degrees of difficulty

<b>Easy</b> , suitable for novice with little experience 	<b>Fairly easy</b> , suitable for beginner with some experience 	<b>Fairly difficult</b> , suitable for competent DIY mechanic 	<b>Difficult</b> , suitable for experienced DIY mechanic 	<b>Very difficult</b> , suitable for expert DIY or professional 
---	--	--	---	--

### Specifications

#### General

Type ..... Manual, five forward speeds and reverse. Synchromesh on all forward speeds

#### Designation

<b>Petrol models:</b>	
1.4 litre engines .....	MA5
1.6 litre engines .....	BE4/5
<b>Diesel models:</b>	
1.8 litre engines .....	BE3/5
1.9 litre:	
XUD series engines .....	BE3/5
DW series engines:	
Up to September 2002 .....	BE3/5
September 2002 onward .....	BE4/5
2.0 litre engines:	
Up to September 2002 .....	BE3/5
September 2002 onward .....	BE4/5

#### Lubrication

<b>Capacity:</b>	
MA5 transmission .....	2.0 litres
BE3/5 transmission .....	1.8 litres
BE4/5 transmission .....	1.9 litres



**Torque wrench settings**

	Nm	lbf ft
<b>MA5 transmission</b>		
Clutch release bearing guide sleeve bolts	6	4
Engine-to-transmission fixing bolts	40	30
Gearchange lever mounting nuts	8	6
Left-hand engine/transmission mounting	Refer to Chapter 2A	
Oil drain plug	25	18
Oil filler/level plug	25	18
Rear mounting link	Refer to Chapter 2A	
Reversing light switch	25	18
Roadwheel bolts	90	66
<b>BE3/5 and BE4/5 transmission</b>		
Clutch release bearing guide sleeve bolts	12	9
Engine-to-transmission fixing bolts	50	37
Gearchange lever mounting nuts	8	6
Left-hand engine/transmission mounting	Refer to Chapter 2A, 2B or 2C	
Oil drain plug	30	22
Oil filler/level plug	20	15
Rear mounting link	Refer to Chapter 2A, 2B or 2C	
Reversing light switch	25	18
Roadwheel bolts	90	66
Speedometer drive housing bolts	20	15

**1 General information**

**1** The transmission is contained in a cast-aluminium alloy casing bolted to the engine's left-hand end, and consists of the gearbox and final drive differential – often called a transaxle.

**2** Drive is transmitted from the crankshaft via the clutch to the input shaft, which has a splined extension to accept the clutch friction disc, and rotates in sealed ball-bearings. From the input shaft, drive is transmitted to the output shaft, which rotates in a roller bearing at its right-hand end, and a sealed ball-bearing at its left-hand end. From the output shaft, the drive is transmitted to the differential crownwheel, which rotates with the differential case and planetary gears, thus driving the sun gears and driveshafts. The rotation of the planetary gears on their shaft allows the inner roadwheel to rotate at a slower speed than the outer roadwheel when the car is cornering.

**3** The input and output shafts are arranged side-by-side, parallel to the crankshaft and driveshafts, so that their gear pinion teeth are in constant mesh. In the neutral position, the output shaft gear pinions rotate freely, so that drive cannot be transmitted to the crownwheel.

**4** Gear selection is via a floor-mounted lever and selector rod mechanism. The selector rod causes the appropriate selector fork to move its respective synchro-sleeve along the shaft, to lock the gear pinion to the synchro-hub. Since the synchro-hubs are splined to the output shaft, this locks the pinion to the shaft,

so that drive can be transmitted. To ensure that gearchanging can be made quickly and quietly, a synchromesh system is fitted to all forward gears, consisting of baulk rings and spring-loaded fingers, as well as the gear pinions and synchro-hubs. The synchromesh cones are formed on the mating faces of the baulk rings and gear pinions.

**5** Three different manual transmissions are used on the models covered in this manual, however all are similar in construction and operation. Any differences which affect the procedures covered in this Chapter are described in the Section concerned.

**2 Manual transmission – draining and refilling**

**Note:** A suitable square section wrench may be required to undo the transmission filler/level and drain plugs on some models. These wrenches can be obtained from most motor factors or your Peugeot/Citroën dealer.

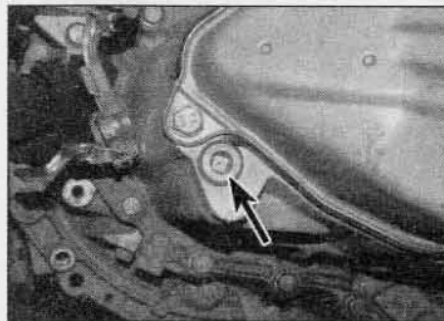

**2.4a** Oil filler/level plug (arrowed) – MA5 transmission

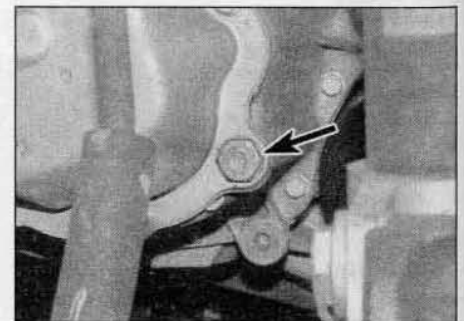

**2.4b** Oil filler/level plug (arrowed) – BE3/5 and BE4/5 transmissions

**1** This operation is much quicker and more efficient if the car is first taken on a journey of sufficient length to warm the engine/transmission up to normal operating temperature.

**2** Park the car on level ground, switch off the ignition and apply the handbrake firmly. For improved access, jack up the front of the car and support it securely on axle stands (see *Jacking and vehicle support*). Note that the car must be level to ensure accuracy when refilling and checking the oil level. Undo the screws and remove the engine undertray (where fitted).

**3** Remove the engine undertray (where fitted) and the left-hand front roadwheel. Remove the plastic wheel arch liner as described in Chapter 11.

**4** Wipe clean the area around the filler/level plug, which is situated on the left-hand end of the transmission, next to the end cover. Unscrew the filler/level plug from the transmission and recover the sealing washer (see illustrations).

**5** Position a suitable container under the

drain plug (situated at the rear of the transmission) and unscrew the plug. On MA5 transmissions, the plug is on the left-hand side of the differential housing; on BE3/5 and BE4/5 transmissions, it is on the base of the differential housing (see illustrations).

6 Allow the oil to drain completely into the container. If the oil is hot, take precautions against scalding. Clean both the filler/level and the drain plugs, being especially careful to wipe any metallic particles off the magnetic inserts. Discard the original sealing washers; they should be renewed whenever they are disturbed.

7 When the oil has finished draining, clean the drain plug threads and those of the transmission casing, fit a new sealing washer and refit the drain plug, tightening it to the specified torque.

8 Refill the transmission slowly, through the filler/level plug orifice, until the oil begins to trickle out of the orifice. Use only good-quality oil of the specified type (refer to *Lubricants and fluids*). To ensure that a correct level is established, wait until the initial trickle has stopped and allow the oil to settle within the transmission. Add a little more oil until a new trickle emerges; the level will be correct when the new flow ceases.

9 When the level is correct, fit a new sealing washer to the filler/level plug, refit the plug and tighten it to the specified torque.

10 Refit the wheel arch liner, engine undertray (where applicable) and roadwheel, then lower the car to the ground. Tighten the roadwheel bolts to the specified torque.

### 3 Gearchange linkage - removal and refitting



**Note:** The gearchange linkage is not adjustable. If difficulty is experienced in gear selection, or if there is excess free play at the gearchange lever, dismantle the linkage and check the condition of the link rod balljoints and pivot bushes as described below.

#### Removal

1 Firmly apply the handbrake, then jack up the front of the vehicle and support it on axle stands (see *Jacking and vehicle support*). Remove the engine undertray (where fitted).

2 Remove the battery, battery tray and mounting plate as described in Chapter 5A. Depending on model and clearance available, remove any remaining air cleaner and air intake duct components as described in the relevant Part of Chapter 4, to gain access to the top of the transmission.

#### MA5 transmission - pre-1998 models

3 Slacken and remove the nut and washer, then withdraw the pivot bolt from each end of the selector rod (see illustration). Disengage the rod from the gearchange lever and selector lever, and remove it from

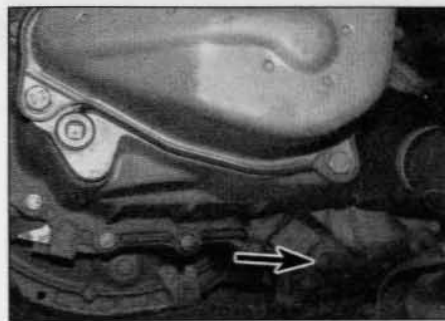

2.5a Oil drain plug (arrowed) - MA5 transmission

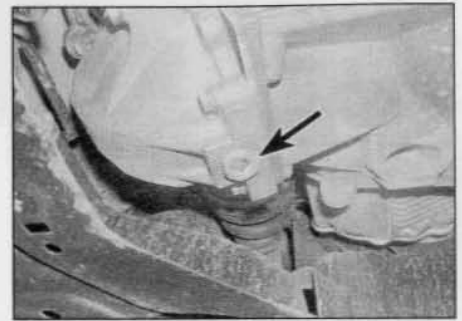

2.5b Oil drain plug (arrowed) - BE3/5 and BE4/5 transmissions

underneath the vehicle. Recover the spacers and pivot bushes from the gearchange lever and transmission selector lever.

4 Undo the two nuts securing the selector

lever mounting bracket to the transmission housing, then remove the bracket and lever assembly from the transmission.

5 Inspect all the linkage components for

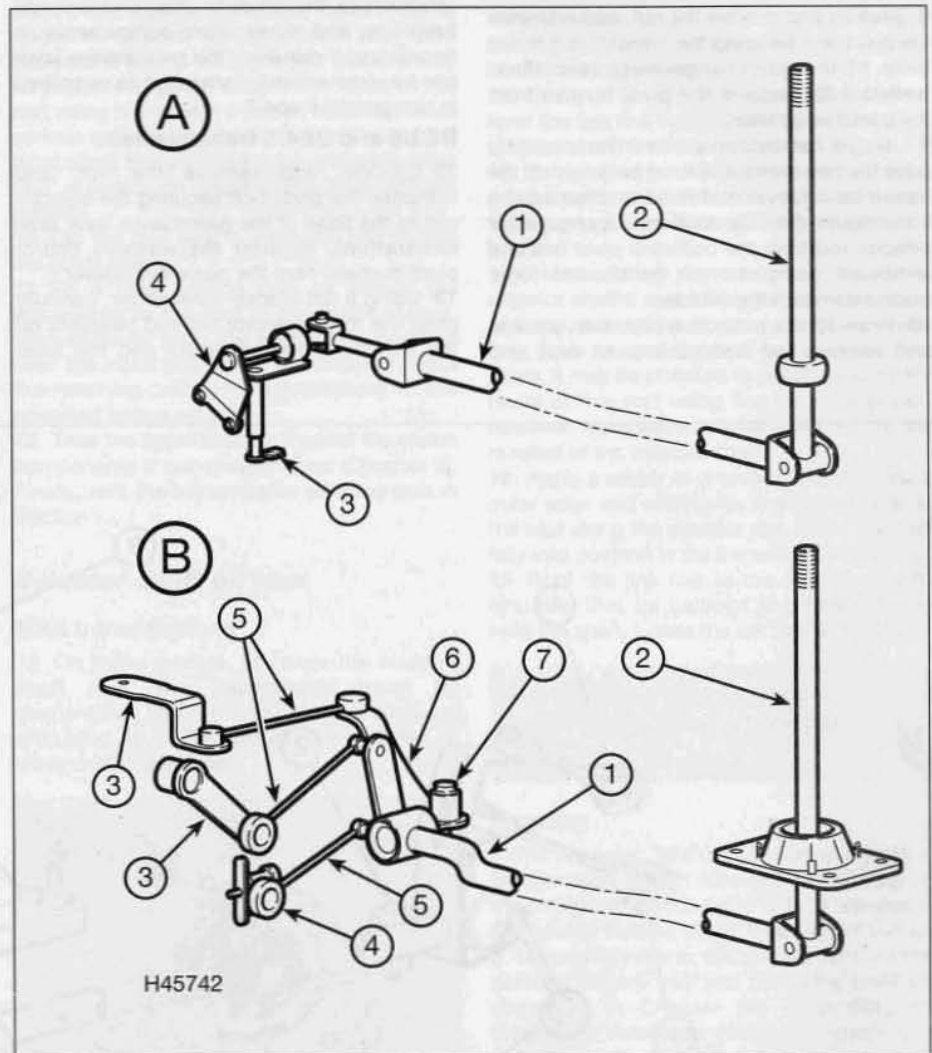

3.3 Gearchange linkage arrangement on the MA5 transmission

- A Pre-1998 models  
B 1998 models onward  
1 Selector rod  
2 Gearchange lever

- 3 Transmission selector lever  
4 Fixed mounting bracket

- 5 Link rods  
6 Bellcrank  
7 Bellcrank pivot bolt

signs of wear or damage, paying particular attention to the pivot bushes, and renew worn components as necessary.

**6** To remove the gearchange lever, remove the centre console as described in Chapter 11, then undo the four retaining nuts and lower the gearchange lever out from underneath the vehicle.

**7** Peel back the lower gaiter from the base of the gearchange lever, then disengage the lever mounting plate. Slide the upper gaiter up the lever to gain access to the gearchange lever pivot ball. Examine the lever components for signs of wear or damage, paying particular attention to the rubber gaiters, and renew components as necessary. The lever can be separated from its baseplate after the retaining ring has been unclipped.

**MA5 transmission – 1998 models onward**

**8** Slacken and remove the nut, and withdraw the pivot bolt securing the selector rod to the base of the gearchange lever (see illustration 3.3). Recover the pivot bushes from the gearchange lever.

**9** Using a flat-bladed screwdriver, carefully prise the two selector link rod balljoints off the transmission lever and fixed bracket on the transmission (see illustration). Disengage the selector rod from the bellcrank pivot ball and remove it, complete with the two link rods, from underneath the vehicle.

**10** Prise off the protective cap, then slacken and remove the bellcrank pivot bolt and

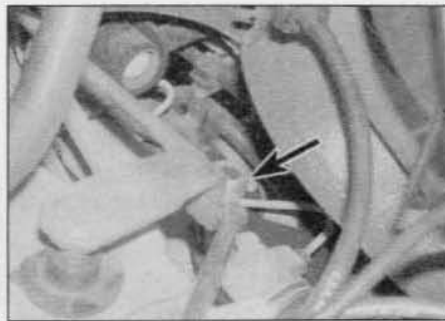

**3.9 Carefully lever the link rods off their balljoints on the transmission unit**

washer. Carefully prise the bellcrank link rod balljoint off the transmission lever and remove the bellcrank and link rod assembly.

**11** Inspect all the linkage components for signs of wear or damage, paying particular attention to the pivot bushes and link rod balljoints, and renew worn components as necessary. If required, the gearchange lever can be removed and dismantled as described in paragraphs 6 and 7.

**BE3/5 and BE4/5 transmissions**

**12** Slacken and remove the nut, and withdraw the pivot bolt securing the selector rod to the base of the gearchange lever (see illustration). Recover the washers and/or pivot bush(es) from the gearchange lever.

**13** Using a flat-bladed screwdriver, carefully prise the three selector link rod balljoints off the two transmission levers and the fixed

bracket. Disengage the selector rod from the bellcrank pivot ball and remove it, with the two link rods, from underneath the vehicle.

**14** Where fitted, carefully prise the plastic cap off the pivot bolt securing the gearchange linkage bellcrank to the subframe.

**15** Slacken and remove the bellcrank pivot bolt and washer, or the nut and washer from the bellcrank shaft, then manoeuvre the bellcrank and the remaining link rod out from under the vehicle. Where applicable, recover the spacer and pivot bushes from the centre of the bellcrank.

**16** Inspect all the linkage components for signs of wear or damage, paying particular attention to the pivot bushes and link rod balljoints, and renew worn components as necessary. If required, the gearchange lever can be removed and dismantled as described above in paragraphs 6 and 7.

**Refitting**

**17** Refitting is a reversal of the removal procedure, noting the following points:

- a) Apply a smear of multi-purpose grease to the bellcrank pivot ball. Do not grease the link rod balljoints or the pivot bushes.
- b) Ensure that all link rods are securely pressed onto their balljoints.
- c) Where applicable, refit the air cleaner components (Chapter 4A, 4B or 4C), the mounting plate, battery tray and battery (Chapter 5A) and the centre console (Chapter 11).

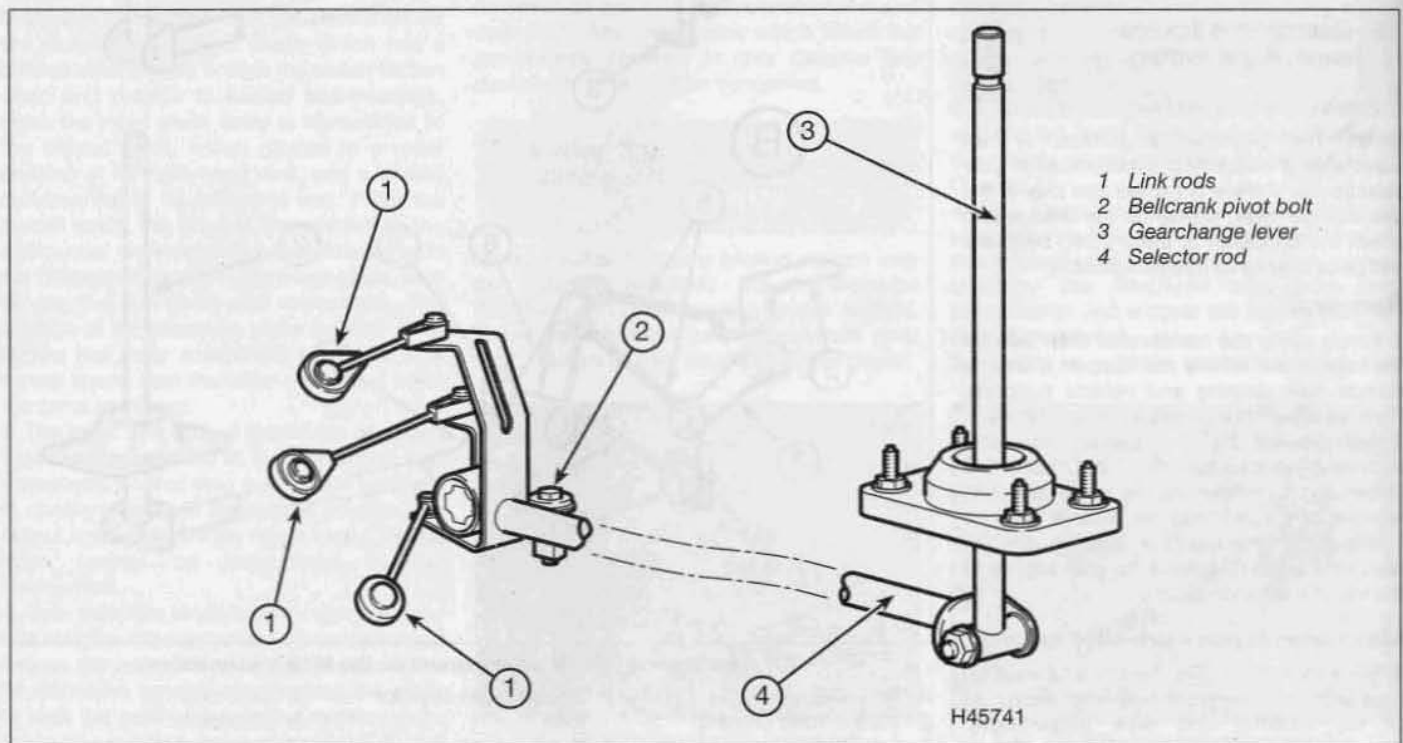

**3.12 Gearchange linkage arrangement on the BE3/5 and BE4/5 transmissions**



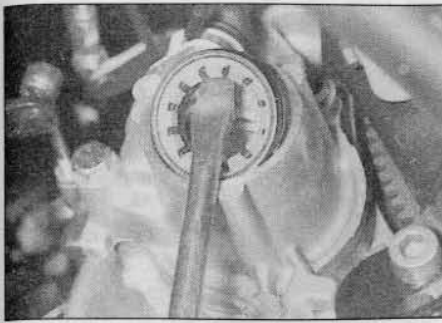

4.2 Using a large flat-bladed screwdriver to lever the right-hand oil seal out of position – BE3/5 transmission shown

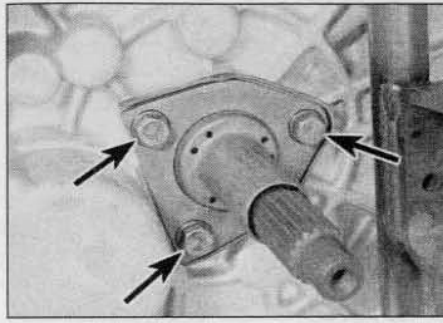

4.7a Clutch release bearing guide sleeve retaining bolts (arrowed) on the MA5 and BE3/5 transmissions . . .

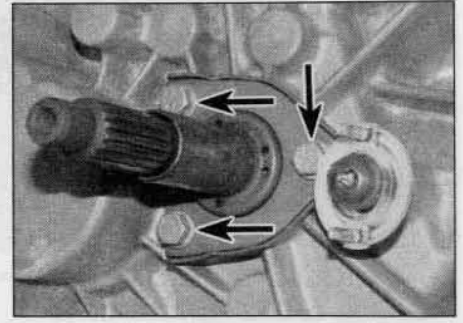

4.7b . . . and on the BE4/5 transmission

#### 4 Oil seals – renewal

##### Driveshaft oil seals

- 1 Remove the appropriate driveshaft as described in Chapter 8.
- 2 Carefully prise the oil seal out of the transmission, using a large flat-bladed screwdriver (see illustration).
- 3 Remove all traces of dirt from the area around the oil seal aperture, then apply a smear of grease to the outer lip of the new oil seal. Fit the new seal into its aperture, and drive it squarely into position using a suitable tubular drift (such as a socket) which bears only on the hard outer edge of the seal, until it abuts its locating shoulder.
- 4 Apply a thin film of grease to the oil seal lip.
- 5 Refit the driveshaft as described in Chapter 8.

##### Input shaft oil seal

- 6 Remove the transmission as described in Section 7, and the clutch release mechanism as described in Chapter 6.
- 7 Undo the three bolts securing the clutch release bearing guide sleeve in position, and slide the guide off the input shaft, along with its sealing ring or gasket (as applicable) (see illustrations). Recover any shims or thrustwashers which have stuck to the rear of the guide sleeve, and refit them to the input shaft.

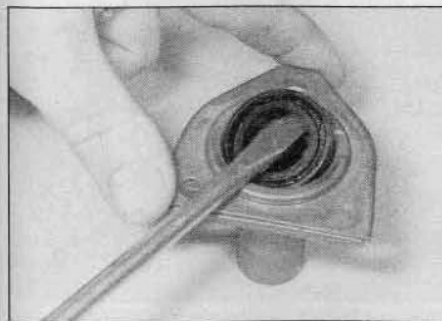

4.8 Carefully lever the oil seal out of the guide sleeve, noting which way round it is fitted

- 8 Carefully lever the oil seal out of the guide sleeve using a suitable flat-bladed screwdriver (see illustration).

- 9 Before fitting a new seal, check the input shaft's seal rubbing surface for signs of burrs, scratches or other damage, which may have caused the seal to fail in the first place. It may be possible to polish away minor faults of this sort using fine abrasive paper; however, more serious defects will require the renewal of the input shaft. Ensure that the input shaft is clean and greased, to protect the seal lips on refitting.

- 10 Dip the new seal in clean oil, and fit it to the guide sleeve.

- 11 Fit a new sealing ring or gasket (as applicable) to the rear of the guide sleeve, then carefully slide the sleeve into position over the input shaft (see illustration). Refit the retaining bolts and tighten them to the specified torque setting.

- 12 Take the opportunity to inspect the clutch components if not already done (Chapter 6). Finally, refit the transmission as described in Section 7.

##### Selector shaft oil seal

###### MA5 transmissions

- 13 On these models, to renew the selector shaft seal, the transmission must be dismantled. This task should therefore be entrusted to a Peugeot/Citroën dealer or transmission specialist.

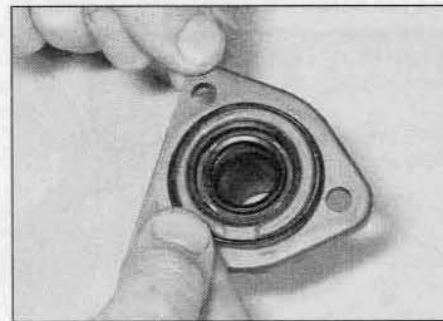

4.11 Fit a new sealing ring or gasket (as applicable) to the rear of the guide sleeve

##### BE3/5 and BE4/5 transmissions

- 14 Park the car on level ground, apply the handbrake, slacken the left-hand front roadwheel bolts, then jack up the front of the vehicle and support it on axle stands (see *Jacking and vehicle support*). Remove the left-hand front roadwheel.

- 15 Using a large flat-bladed screwdriver, lever the link rod balljoint off the transmission selector shaft, and disconnect the link rod.

- 16 Using a large flat-bladed screwdriver, carefully prise the selector shaft seal out of the housing, and slide it off the end of the shaft.

- 17 Before fitting a new seal, check the selector shaft's seal rubbing surface for signs of burrs, scratches or other damage, which may have caused the seal to fail in the first place. It may be possible to polish away minor faults of this sort using fine abrasive paper; however, more serious defects will require the renewal of the selector shaft.

- 18 Apply a smear of grease to the new seal's outer edge and sealing lip, then carefully slide the seal along the selector rod. Press the seal fully into position in the transmission housing.

- 19 Refit the link rod to the selector shaft, ensuring that its balljoint is pressed firmly onto the shaft. Lower the car to the ground.

#### 5 Reversing light switch – testing, removal and refitting

##### Testing

- 1 The reversing light circuit is controlled by a plunger-type switch screwed into the top of the transmission casing. If a fault develops, first ensure that the circuit fuse has not blown.

- 2 To gain access to the switch, remove the battery, battery tray and mounting plate as described in Chapter 5A. Depending on model and clearance available, remove any remaining air cleaner and air intake duct components as described in the relevant Part of Chapter 4.

- 3 To test the switch, disconnect the wiring connector, and use a multimeter (set to the resistance function) or a battery-and-bulb test

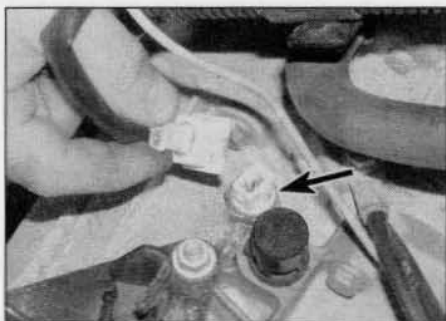

5.5a Reversing light switch location (arrowed) on the MA5 transmission . . .

circuit to check that there is continuity between the switch terminals only when reverse gear is selected. If this is not the case, and there are no obvious breaks or other damage to the wires, the switch is faulty, and must be renewed.

### Removal

4 To gain access to the switch, remove the battery, battery tray and mounting plate as described in Chapter 5A. Depending on model and clearance available, remove any remaining air cleaner and air intake duct components as described in the relevant Part of Chapter 4.

5 Disconnect the wiring connector, then unscrew the switch from the transmission casing along with its sealing washer (see illustrations).

### Refitting

6 Fit a new sealing washer to the switch, then screw it back into position in the top of the transmission housing and tighten it to the specified torque setting. Refit the wiring plug, and test the operation of the circuit. Refit the components removed for access.

## 6 Speedometer drive – removal and refitting

### Removal

1 Chock the rear wheels, firmly apply the

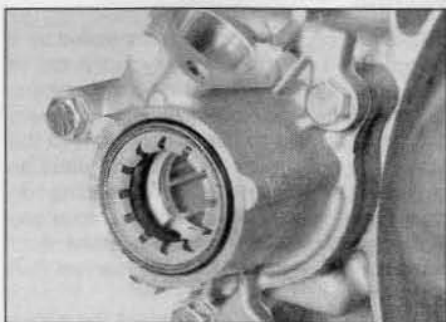

6.7a On BE3/5 and BE4/5 transmissions, unscrew the housing retaining bolts . . .

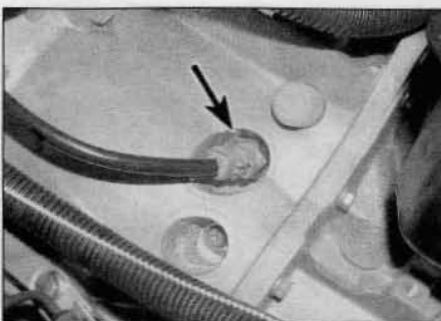

5.5b . . . and on the BE4/5 transmission

handbrake, then jack up the front of the car and support it on axle stands (see *Jacking and vehicle support*). The speedometer drive is on the rear of the transmission housing, next to the inner end of the right-hand driveshaft. Undo the screws and remove the engine undertray (where fitted).

2 Disconnect the wiring connector from the speedometer drive (see illustration).

3 Slacken and remove the retaining bolt and remove the heat shield (where fitted). Withdraw the speedometer drive and driven pinion assembly from the transmission housing, along with its sealing ring.

4 If necessary, the pinion can be slid out of the housing, and the oil seal removed from the top of the housing. Examine the pinion for signs of damage, and renew if necessary. Renew the housing sealing ring as a matter of course.

5 If the driven pinion is worn or damaged, also examine the drive pinion in the transmission housing for similar signs.

6 To renew the drive pinion on MA5 transmissions, the transmission must be dismantled and the differential gear removed. This task should therefore be entrusted to a Peugeot/Citroën dealer or a transmission specialist.

7 To remove the drive pinion on BE3/5 and BE4/5 transmissions, first remove the right-hand driveshaft as described in Chapter 8. Undo the three retaining bolts and remove the speedometer drive housing from the



6.7b . . . and remove the housing, sealing ring and drive pinion from the transmission

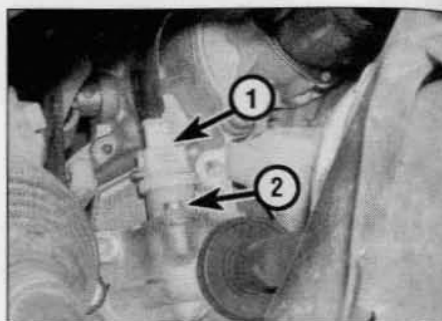

6.2 Speedometer drive wiring connector (1) and retaining bolt (2)

transmission, along with its sealing ring. Remove the drive pinion from the differential gear, and recover any adjustment shims from the gear (see illustrations).

### Refitting

8 On BE3/5 and BE4/5 transmissions, where the drive pinion has been removed, refit the adjustment shims to the differential gear, then locate the speedometer drive on the gear, ensuring it is correctly engaged in the gear slots (see illustration). Fit a new sealing ring to the rear of the speedometer drive housing, then refit the housing to the transmission and tighten its retaining bolts to the specified torque. Inspect the driveshaft oil seal for signs of wear, and renew if necessary. Refit the driveshaft as described in Chapter 8.

9 On all transmissions, apply a smear of grease to the lips of the seal and to the driven pinion shaft, and slide the pinion into position in the speedometer drive.

10 Fit a new sealing ring to the speedometer drive and refit it to the transmission, ensuring that the drive and driven pinions are correctly engaged. Refit the drive retaining bolt, complete with heat shield (where fitted), and tighten securely.

11 Reconnect the wiring connector to the speedometer drive, refit the engine undertray (where applicable), then lower the vehicle to the ground.

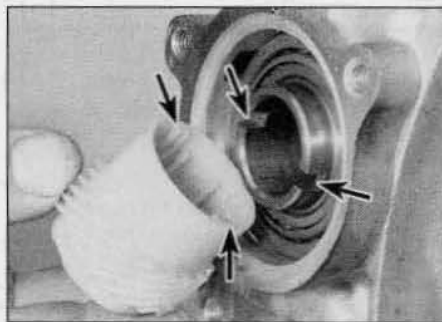

6.8 On BE3/5 and BE4/5 transmissions, ensure the drive pinion dogs are correctly engaged with the gear slots (arrowed) when refitting



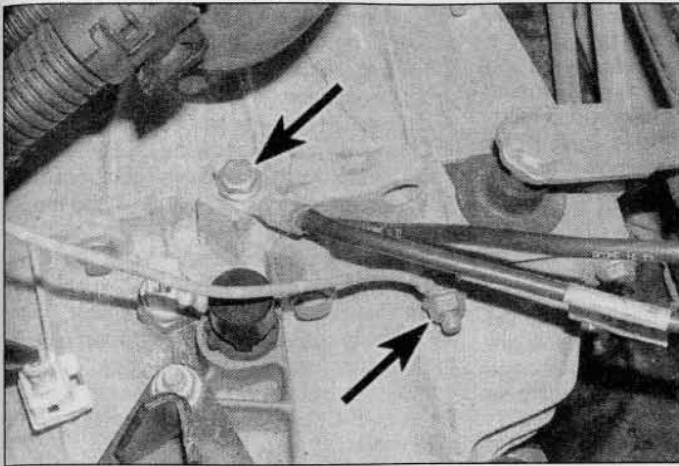

**7.8a** Unscrew the nut and bolt and detach the earth leads (arrowed) from the transmission – MA5 transmission

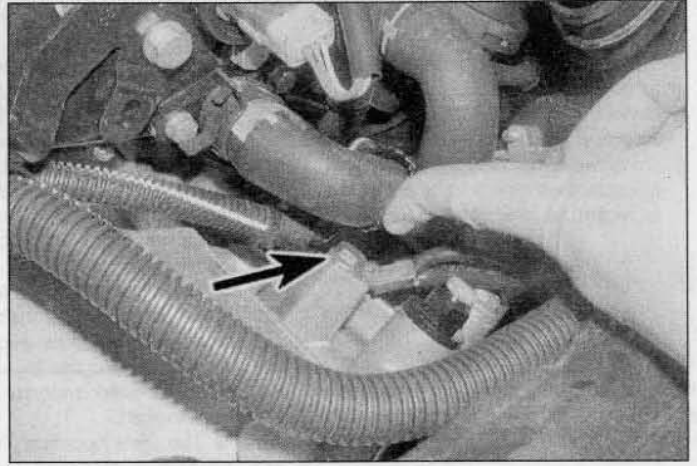

**7.8b** Unscrew the bolt (arrowed) and disconnect the earth lead from the transmission – BE3/5 and BE4/5 transmissions

## 7 Manual transmission – removal and refitting



### Removal

- 1 Firmly apply the handbrake, then jack up the front of the car and support it securely on axle stands (see *Jacking and vehicle support*).
- 2 Drain the transmission oil as described in Section 2, then refit the drain and filler plugs, tightening them to the specified torque.
- 3 Remove the air cleaner and air intake duct(s) as described in the relevant Part of Chapter 4. On D9B diesel engines, also remove the air distribution housing as described in Chapter 4B.
- 4 Remove the battery, battery tray and mounting plate as described in Chapter 5A.
- 5 Remove both driveshafts as described in Chapter 8.
- 6 Remove the starter motor as described in Chapter 5A.
- 7 Refer to Chapter 6 and release the clutch inner cable end fitting from the release fork/lever. Depress the retaining tabs and release the outer cable from the transmission bracket.
- 8 Disconnect the wiring connector from the reversing light switch, TDC sensor and speedometer drive. Undo the retaining nuts/bolts, and disconnect the earth straps from the transmission housing (see **illustrations**). Disconnect the wiring from any additional switches/sensors as necessary, free the wiring loom from the retaining clips, and position it clear of the transmission.
- 9 On the MA5 transmission, undo the bolt securing the exhaust front pipe to its transmission mounting bracket.
- 10 On pre-1998 MA5 transmissions, slacken and remove the nut and washer, then withdraw the pivot bolt securing the selector rod to the transmission selector lever. Disengage the rod from the selector lever. On

all other transmissions, using a flat-bladed screwdriver, carefully prise the gearchange mechanism link rod balljoints off their respective levers on the transmission. Position the rods clear of the transmission.

11 On models with power steering, undo the retaining nuts and bolts and release the power steering pipe support brackets from the transmission. Position the pipe clear of the unit so that it will not be damaged during the removal procedure.

12 Undo the retaining bolt(s), and remove the flywheel lower cover plate (where fitted) from the transmission.

13 On the BE3/5 and BE4/5 transmissions, remove the speedometer drive housing from the transmission as described in Section 6.

14 Place a jack with a block of wood beneath the engine, to take the weight of the engine. Alternatively, attach a couple of lifting eyes to the engine, and fit a hoist or support bar to take the engine weight.

15 Place a jack and block of wood beneath the transmission, and raise the jack to take the weight of the transmission.

16 Undo the nut and bolt securing the engine/transmission rear mounting connecting link to the bracket on the subframe.

17 Slacken and remove the centre nut and washer from the left-hand engine/transmission mounting. Undo the two bolts/nuts securing the mounting to the support bracket, and remove the rubber mounting.

18 On the MA5 transmission, undo the three retaining nuts and remove the mounting plate from the top of the transmission.

19 On the BE3/5 and BE4/5 transmission, remove the washer and spacer from the mounting stud, then unscrew the stud from the top of the transmission housing. Collect the large spacer plate from the mounting stud.

20 With the jack positioned beneath the transmission taking the weight, slacken and remove the remaining bolts securing the

transmission housing to the engine. Note the correct fitted positions of each bolt, and the necessary brackets, as they are removed to use as a reference on refitting. Make a final check that all components have been disconnected, and are positioned clear of the transmission so that they will not hinder the removal procedure.

21 With the bolts removed, move the trolley jack and transmission to the left, to free it from its locating dowels then pivot the differential end of the transmission upwards (to disengage it from the subframe).

**Caution: Take great care not to place any excess strain on the exhaust system, or damage the radiator if the engine is moved. On models equipped with air conditioning, care must also be taken to ensure the auxiliary drivebelt pulleys do not damage the air conditioning pipes on the right-hand side of the engine compartment.**

22 Once the transmission is free, lower the jack and manoeuvre the unit out from under the car. Remove the locating dowels from the transmission or engine if they are loose, and keep them in a safe place.

### Refitting

23 The transmission is refitted by a reversal of the removal procedure, bearing in mind the following points:

- a) Apply a little high melting-point grease (Peugeot/Citroën recommend the use of Molykote BR2 plus – available from your dealer) to the splines of the transmission input shaft. Do not apply too much, otherwise there is a possibility of the grease contaminating the clutch friction disc.
- b) Ensure that the locating dowels are correctly positioned prior to installation.
- c) On the BE3/5 and BE4/5 transmissions, apply thread-locking fluid to the left-hand engine/transmission mounting stud threads, prior to refitting it to the



transmission. Tighten the stud to the specified torque.

- d) Tighten all nuts and bolts to the specified torque (where given).
- e) Renew the driveshaft oil seals (Section 5), then refit the driveshafts (see Chapter 8).
- f) On completion, refill the transmission with the specified type and quantity of lubricant, as described in Section 2.

## 8 Manual transmission overhaul – general information

**1** Overhauling a manual transmission is a difficult and involved job for the DIY home mechanic. In addition to dismantling and

reassembling many small parts, clearances must be precisely measured and, if necessary, changed by selecting shims and spacers. Internal transmission components are also often difficult to obtain, and in many instances, extremely expensive. Because of this, if the transmission develops a fault or becomes noisy, the best course of action is to have the unit overhauled by a specialist repairer, or to obtain an exchange reconditioned unit.

**2** Nevertheless, it is not impossible for the more experienced mechanic to overhaul the transmission, provided the special tools are available, and the job is done in a deliberate step-by-step manner, so that nothing is overlooked.

**3** The tools necessary for an overhaul include

internal and external circlip pliers, bearing pullers, a slide hammer, a set of pin punches, a dial test indicator, and possibly a hydraulic press. In addition, a large, sturdy workbench and a vice will be required.

**4** During dismantling of the transmission, make careful notes of how each component is fitted, to make reassembly easier and more accurate.

**5** Before dismantling the transmission, it will help if you have some idea what area is malfunctioning. Certain problems can be closely related to specific areas in the transmission, which can make component examination and renewal easier. Refer to the *Fault finding* Section for more information.





# Chapter 8

## Driveshafts

### Contents

	Section number		Section number
Driveshaft overhaul – general information .....	5	Driveshaft rubber gaiters (PSA type driveshaft) – renewal .....	4
Driveshaft rubber gaiter and constant velocity (CV) joint check .....	See Chapter 1A or 1B	Driveshafts – removal and refitting .....	2
Driveshaft rubber gaiters (GKN type driveshaft) – renewal .....	3	General information .....	1
		Right-hand driveshaft intermediate bearing – renewal .....	6

### Degrees of difficulty

<b>Easy</b> , suitable for novice with little experience 	<b>Fairly easy</b> , suitable for beginner with some experience 	<b>Fairly difficult</b> , suitable for competent DIY mechanic 	<b>Difficult</b> , suitable for experienced DIY mechanic 	<b>Very difficult</b> , suitable for expert DIY or professional 
---	--	--	---	--

### Specifications

#### Lubrication (overhaul only – see text)

Lubricant type/specification .....	Use only special grease supplied in sachets with gaiter kits – joints are otherwise pre-packed with grease and sealed
------------------------------------	---

#### Torque wrench settings

	Nm	lbf ft
Anti-roll bar connecting link retaining nut* .....	40	30
Driveshaft retaining nut* .....	320	236
Lower suspension arm balljoint retaining nuts* .....	40	30
Right-hand driveshaft intermediate bearing retaining bolt nuts* .....	17	13
Roadwheel bolts .....	90	66

\* New nuts must be used

#### 1 General information

Drive is transmitted from the differential to the front wheels by means of two unequal-length driveshafts.

Both driveshafts are splined at their outer ends, to accept the wheel hubs, and are threaded so that each hub can be fastened by a large nut. The inner end of each driveshaft is splined, to accept the differential sun gear.

Constant velocity (CV) joints are fitted to each end of the driveshafts, to ensure the smooth and efficient transmission of power at all suspension and steering angles.

Driveshafts from two different manufacturers may be encountered. On the GKN type driveshaft, the outer constant velocity

joints are of the spider-and-yoke type and the inner constant velocity joints are of the tripod type. On the PSA type driveshaft, the outer constant velocity joints are of the ball-and-cage type, with the inner constant velocity joints being of the tripod type. The constant velocity joints are visually different on the two driveshaft types, and the photos accompanying Sections 3 and 4 can be used to aid identification.

Due to the length of the right-hand driveshaft, the inner constant velocity joint on all models is situated approximately halfway along the shaft's length, and an intermediate support bearing is mounted in the engine/transmission rear mounting bracket. The inner end of the driveshaft passes through the bearing (which prevents any lateral movement of the driveshaft inner end) and the inner constant velocity joint outer member.

#### 2 Driveshafts – removal and refitting

**Note:** Do not allow the vehicle to rest on its wheels with one or both driveshafts removed, as damage to the wheel bearing(s) may result. If moving the vehicle is unavoidable, temporarily insert the outer end of the driveshaft(s) in the hub(s) and tighten the hub nut(s); in this case, the inner end(s) of the driveshaft(s) must be supported, for example by suspending with string from the vehicle underbody. Do not allow the driveshaft to hang down under its own weight. A new driveshaft retaining nut, lower arm balljoint clamp bolt nut and anti-roll bar connecting link nut must be used on refitting.

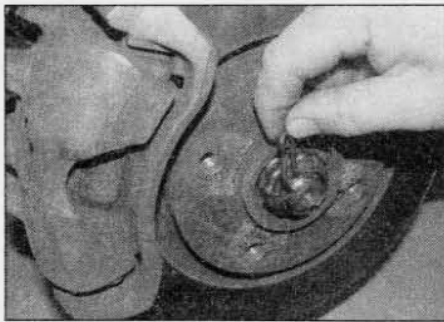

2.4a Withdraw the R-clip . . .

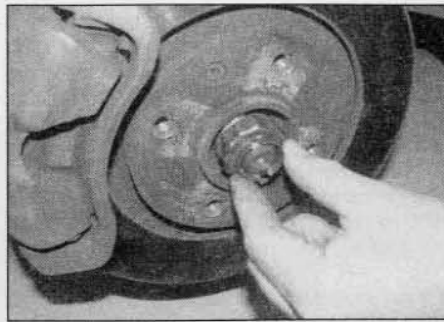

2.4b . . . and remove the locking cap from the driveshaft retaining nut

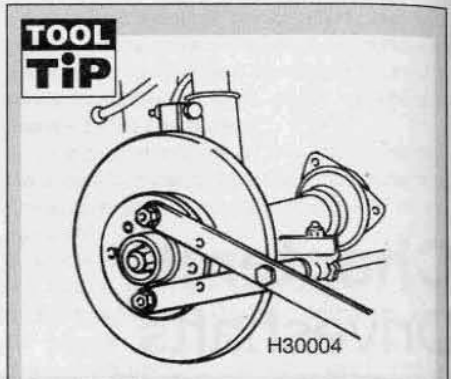

**A tool to hold the front hub stationary whilst the driveshaft retaining nut is slackened can be fabricated from two lengths of steel strip (one long, one short) and a nut and bolt; the nut and bolt forming the pivot of a forked tool.**

**Removal**

- 1 Firmly apply the handbrake, then jack up the front of the car and support it securely on axle stands (see *Jacking and vehicle support*). Remove the appropriate front roadwheel.
- 2 Remove the appropriate front roadwheel.
- 3 Drain the transmission oil as described in Chapter 7.
- 4 Withdraw the R-clip and remove the locking cap from the driveshaft retaining nut (see illustrations).
- 5 To prevent rotation of the wheel hub as the driveshaft retaining nut is slackened, make up a holding tool and bolt the tool to the wheel hub using two wheel bolts (see **Tool Tip**).
- 6 With the holding tool in place, slacken and remove the driveshaft retaining nut using a socket and long bar (see illustration). Where necessary, support the socket on an axle

- stand to prevent it slipping off the nut. This nut is very tight; make sure that there is no risk of pulling the car off the axle stands as the nut is slackened.
- 7 Undo the nut and remove the washer securing the connecting link to the anti-roll bar. Swivel the connecting link to one side.
- 8 Slacken and remove the nut, then withdraw the lower suspension arm balljoint clamp bolt from the swivel hub. Discard the nut – a new one must be used on refitting (see illustration).
- 9 Tap a small chisel into the split on the swivel hub, to spread the hub slightly and allow the balljoint shank to be withdrawn (see illustration). Pull the lower suspension arm downwards to release the balljoint shank from the swivel hub. To do this it will be necessary to use a long bar and block of wood which will engage under the front subframe. Attach the

- bar to the suspension arm, preferably with a chain, or alternatively with a stout strap or rope. Lever down on the bar to release the balljoint from the swivel hub (see illustration).
- 10 Once the balljoint is free, remove the protector plate which is fitted to the balljoint shank (see illustration).

**Left-hand driveshaft**

- 11 Carefully pull the swivel hub assembly outwards, and withdraw the driveshaft outer constant velocity joint from the hub assembly (see illustration). If necessary, the shaft can

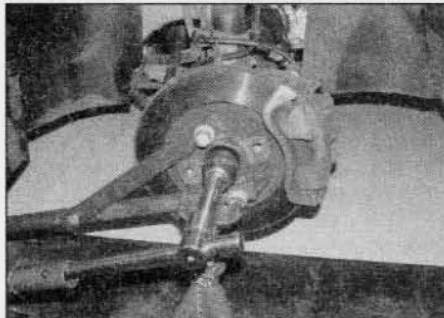

2.6 With the holding tool in place, slacken and remove the driveshaft retaining nut using a socket and long bar



2.8 Undo the nut and withdraw the lower suspension arm balljoint clamp bolt from the swivel hub

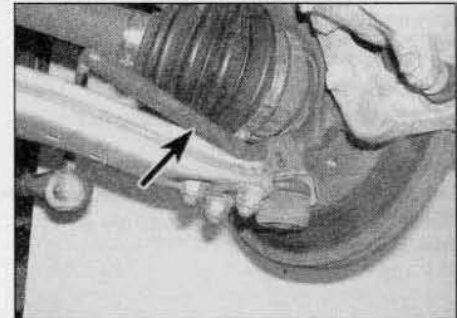

2.9a Spread the swivel hub by tapping a small chisel (arrowed) into the split . . .

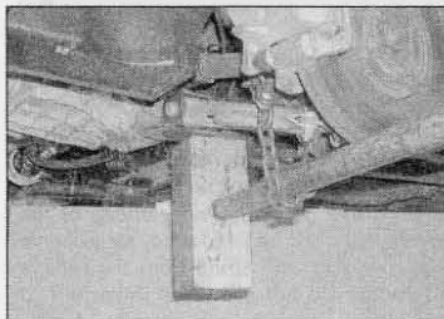

2.9b . . . then pull the lower suspension arm downwards using a bar and chain or similar arrangement, pivoting on the subframe

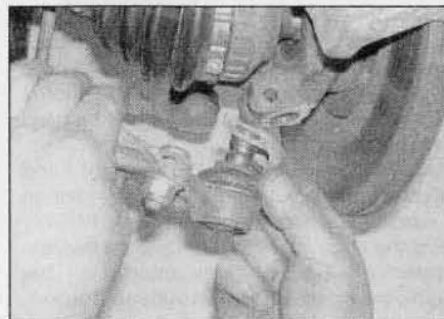

2.10 When the balljoint is released, remove the protector plate from the balljoint shank

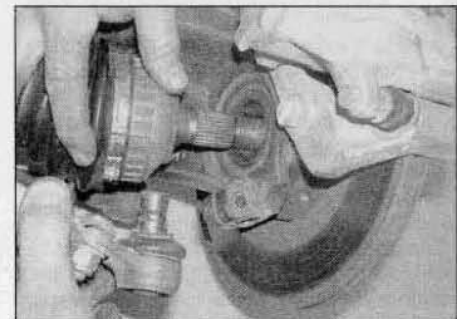

2.11 Pull the swivel hub outwards, and withdraw the driveshaft outer constant velocity joint from the hub





**2.12 Support the driveshaft, then withdraw the inner constant velocity joint from the transmission**

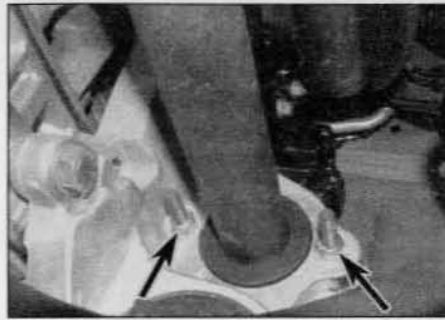

**2.13 On the right-hand driveshaft, slacken the intermediate bearing retaining bolt nuts (arrowed), then turn the bolts through 90°**



**2.15 Free the shaft inner end from the transmission, and the intermediate bearing from its mounting bracket**

be tapped out of the hub using a soft-faced mallet. Take care not to strain the brake hydraulic hose or, where fitted, the ABS wheel speed sensor wiring as the swivel hub is pulled outwards.

**12** Support the driveshaft, then withdraw the inner constant velocity joint from the transmission, taking care not to damage the driveshaft oil seal (see illustration). Remove the driveshaft from the vehicle.

#### Right-hand driveshaft

**13** Loosen the two intermediate bearing retaining bolt nuts, then rotate the bolts through 90°, so that their offset heads are clear of the bearing outer race (see illustration).

**14** Carefully pull the swivel hub assembly outwards, and withdraw the driveshaft outer constant velocity joint from the hub assembly. If necessary, the shaft can be tapped out of the hub using a soft-faced mallet. Take care not to strain the brake hydraulic hose or, where fitted, the ABS wheel speed sensor wiring as the swivel hub is pulled outwards.

**15** Support the outer end of the driveshaft, then pull on the inner end of the shaft to free the shaft from the transmission, and the intermediate bearing from its mounting bracket (see illustration). Remove the driveshaft from the vehicle.

#### Refitting

**16** Before installing the driveshaft, examine the driveshaft oil seal in the transmission for signs of damage or deterioration and, if necessary, renew it as described in Chapter 7. (Having got this far it is worth renewing the seal as a matter of course.)

**17** Thoroughly clean the driveshaft splines, and the apertures in the transmission and hub assembly. Apply a thin film of grease to the oil seal lips, and to the driveshaft splines and shoulders. Check that all gaiter clips are securely fastened.

#### Left-hand driveshaft

**18** Offer up the driveshaft, and locate the joint splines with those of the differential sun gear, taking great care not to damage the oil seal. Push the joint fully into position.

**19** Locate the outer constant velocity joint splines with those of the swivel hub, and slide the joint back into position in the hub.

**20** Refit the protector plate to the lower arm balljoint then, using the method employed on removal, locate the balljoint shank in the swivel hub, ensuring that the lug on the protector plate is correctly located in the clamp split. Insert the balljoint clamp bolt, then fit the new retaining nut and tighten it to the specified torque.

**21** Lubricate the inner face and threads of the new driveshaft retaining nut with clean engine oil, and refit it to the end of the driveshaft. Use the method employed on removal to prevent the hub from rotating, and tighten the driveshaft retaining nut to the specified torque. Check that the hub rotates freely.

**22** Engage the locking cap with the driveshaft nut so that one of its cut-outs is aligned with the driveshaft hole. Secure the cap in position with the R-clip.

**23** Locate the connecting link on the anti-roll bar and refit the washer and a new retaining nut. Tighten the nut to the specified torque.

**24** Where necessary, reconnect the ABS wheel sensor wiring connector, ensuring that the wiring is correctly routed and retained by all the necessary clips and ties.

**25** Refill the transmission with the specified type and quantity of oil as described in Chapter 7.

**26** On completion, refit the roadwheel, then lower the vehicle to the ground and tighten the roadwheel bolts to the specified torque.

#### Right-hand driveshaft

**27** Check that the intermediate bearing rotates smoothly, without any sign of roughness or undue free play between its inner and outer races. If necessary, renew the bearing as described in Section 5.

**28** Apply a smear of grease to the outer race of the intermediate bearing, then pass the inner end of the driveshaft through the bearing mounting bracket.

**29** Carefully locate the inner driveshaft splines with those of the differential sun gear, taking care not to damage the oil seal. Align

the intermediate bearing with its mounting bracket, and push the driveshaft fully into position. If necessary, use a soft-faced mallet to tap the outer race of the bearing into position in the mounting bracket.

**30** Locate the outer constant velocity joint splines with those of the swivel hub, and slide the joint back into position in the hub.

**31** Ensure that the intermediate bearing is correctly seated, then rotate its retaining bolts back through 90°, so that their offset heads are resting against the bearing outer race. Tighten the retaining nuts to the specified torque.

**32** Carry out the operations described above in paragraphs 20 to 26.

### 3 Driveshaft rubber gaiters (GKN type driveshaft) - renewal

Peugeot  
Citroën

#### Outer joint

**1** Remove the driveshaft as described in Section 2.

**2** Remove the inner constant velocity joint and gaiter as described in paragraphs 13 to 18. It is recommended that the inner gaiter is also renewed, regardless of its apparent condition.

**3** Release the two outer gaiter retaining clips, then slide the gaiter off the inner end of the driveshaft.

**4** Wipe away as much of the old grease as possible (do not use any solvent) to allow the joint components to be inspected.

**5** Check the driveshaft spider and outer member yoke for signs of wear, pitting or scuffing on their bearing surfaces. Also check that the outer member pivots smoothly and easily, with no traces of roughness.

**6** If, on inspection, the spider or outer member reveal signs of wear or damage, it will be necessary to renew the complete driveshaft as an assembly, since no components are available separately. If the joint components are in satisfactory condition, obtain a repair kit from your Peugeot/Citroën dealer, consisting of a new gaiter, retaining

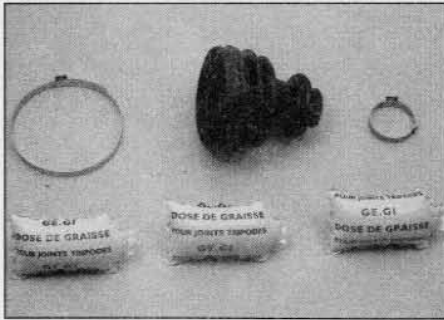

**3.6 Driveshaft outer joint gaiter repair kit components**

clips, and the correct type and quantity of grease (see illustration).

**7** Tape over the splines on the inner end of the driveshaft, then carefully slide the outer gaiter onto the shaft (see illustration).

**8** Pack the joint with the grease supplied in the repair kit (see illustration). Work the grease well into the bearing tracks whilst twisting the joint, and fill the rubber gaiter with any excess.

**9** Ease the gaiter over the joint, and ensure that the gaiter lips are correctly located in the grooves on both the driveshaft and constant velocity joint. Lift the outer sealing lip of the gaiter, to equalise air pressure within the gaiter.

**10** Fit the large metal retaining clip to the gaiter. Remove any slack in the gaiter retaining clip by carefully compressing the raised section of the clip. In the absence of the special tool, a pair of side-cutters may be



**3.10 Securing a gaiter securing clip using side-cutters**

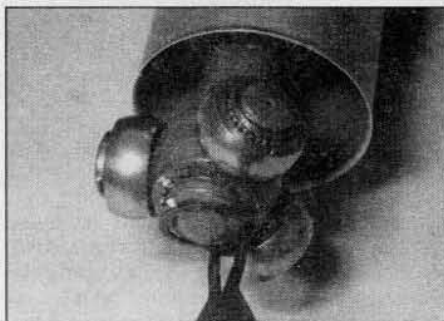

**3.16 Removing the inner tripod joint securing circlip**



**3.7 Sliding the outer joint gaiter onto the driveshaft**

used. Secure the small retaining clip using the same procedure (see illustration). Check that the constant velocity joint moves freely in all directions before proceeding further.

**11** Refit the inner constant velocity joint as described in paragraphs 21 to 28.

**Inner joint**

**12** Remove the driveshaft as described in Section 2.

**13** Secure the driveshaft in a vice equipped with soft jaws then, using a suitable pair of pliers, carefully bend back the lip around the circumference of the constant velocity joint outer member cover (see illustration).

**14** Once the lip of the cover is fully released, pull the joint outer member out from the cover, and recover the spring and thrust cap from the end of the shaft. Remove the O-ring from the outside of the outer member, and discard it.

**15** Fold the gaiter back, and wipe away the

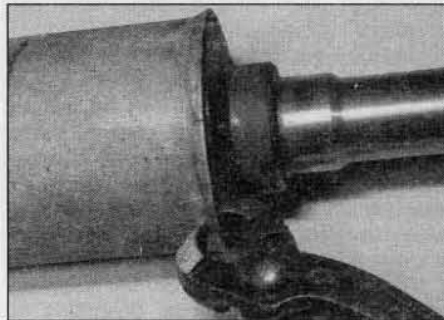

**3.13 Peeling back the lip of the joint outer member cover**



**3.17a Using a three-legged puller to remove the inner tripod joint**



**3.8 Pack the joint with the grease supplied in the repair kit**

excess grease from the tripod joint. If the rollers are not secured to the joint with circlips, wrap adhesive tape around the joint to hold them in position.

**16** Using a dab of paint, or a hammer and punch, mark the relative position of the tripod joint in relation to the driveshaft. Using circlip pliers, extract the circlip securing the joint to the driveshaft (see illustration).

**17** The tripod joint can now be removed. If it is tight, draw the joint off the driveshaft end, using a two- or three-legged bearing puller. Ensure that the legs of the puller are located behind the joint inner member, and do not contact the joint rollers (see illustrations). Alternatively, support the inner member of the tripod joint, and press the shaft out of the joint using a hydraulic press, ensuring that no load is applied to the joint rollers.

**18** With the tripod joint removed, slide the gaiter and inner retaining collar off the end of the driveshaft.

**19** Wipe away as much of the old grease as possible (do not use any solvent) to allow the joint components to be inspected. Take great care not to remove the alignment marks made on dismantling, especially if paint was used.

**20** Examine the tripod joint, rollers and outer member for any signs of scoring or wear, and for smoothness of movement of the rollers on the tripod stems. If any component is worn, the complete driveshaft assembly must be renewed; no joint components are available separately. If the joint components are in good condition, obtain a repair kit from your

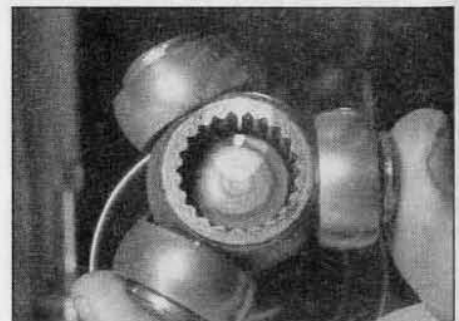

**3.17b Withdrawing the inner tripod joint. Note the alignment marks (made in the previous paragraph)**



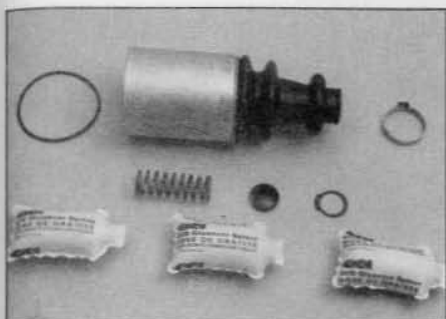

3.20 Driveshaft inner joint gaiter repair kit components

Peugeot/Citroën dealer, consisting of a new rubber gaiter and outer cover assembly, circlip, thrust cap, spring, O-ring, and the correct quantity of the special grease (see illustration).

21 Tape over the splines on the end of the driveshaft, and carefully slide the inner retaining collar and gaiter/cover assembly onto the shaft (see illustrations).

22 Remove the tape, then aligning the marks made on dismantling, engage the tripod joint with the driveshaft splines. Use a hammer and soft metal drift (or a suitable tube or socket) to tap the joint onto the shaft, taking great care not to damage the driveshaft splines or joint rollers (see illustration).

23 Secure the tripod joint in position with the new circlip, ensuring that it is correctly located in the driveshaft groove.

24 Remove the tape, and evenly distribute the special grease contained in the repair kit around the tripod joint and outer member (see illustration). Pack the gaiter/cover with more



3.21a Slide on the inner retaining collar ...



3.21b ... and the gaiter/cover assembly

grease, then draw the cover over the tripod joint. Leave one sachet of grease to lubricate the outer member as the joint is fitted.

25 Fit the new spring, thrust cap and O-ring to the joint outer member (see illustrations).

26 Position the outer member assembly over the tripod joint, and locate the thrust cap

against the end of the driveshaft. Apply the remainder of the grease to the joint, then push the outer member onto the shaft, compressing the spring, and locate it inside the outer cover. Secure the outer member in position by peening the end of the cover evenly over the joint outer edge (see illustrations).

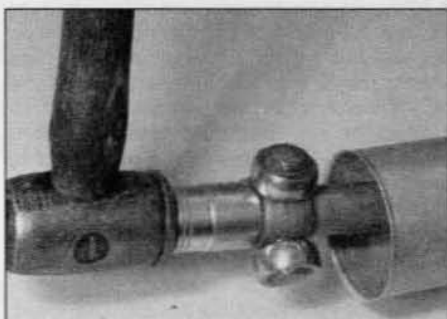

3.22 Using a hammer and a socket to tap the joint onto the driveshaft



3.24 Pack the joint and gaiter/cover with grease

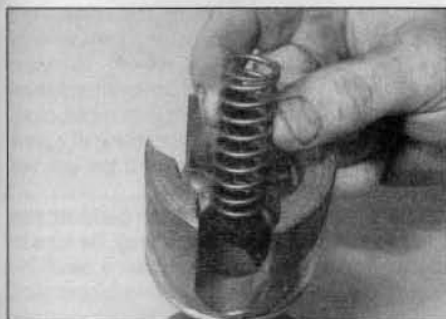

3.25a Fit the new spring ...



3.25b ... thrust cap ...



3.25c ... and O-ring



3.26a Position the outer member over the tripod joint ...



3.26b ... then apply the remainder of the grease ...



3.26c ... and peen over the end of the cover



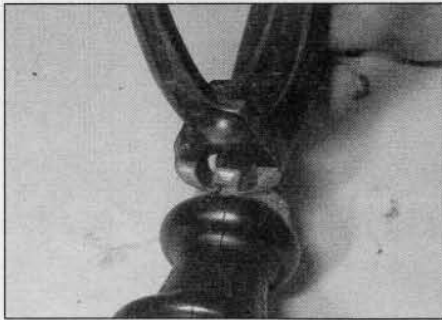

3.27 Securing the inner gaiter clip in position

27 Briefly lift the inner gaiter clip, using a blunt instrument such as a knitting needle, to equalise the air pressure within the gaiter. Secure the inner clip in position (see illustration).

28 Check that the constant velocity joint moves freely in all directions, then refit the driveshaft to the vehicle as described in Section 2.

**4 Driveshaft rubber gaiters (PSA type driveshaft) – renewal**



**Outer joint**

1 Remove the driveshaft as described in Section 2.

2 Release the rubber gaiter outer retaining clip by cutting through it using a junior

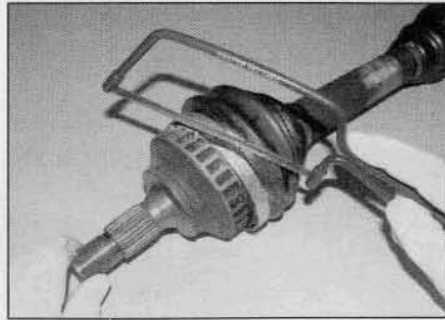

4.2 Release the rubber gaiter outer retaining clip by cutting through it with a hacksaw

hacksaw (see illustration). Spread the clip and remove it from the gaiter.

3 Release the rubber gaiter inner retaining clip using a screwdriver, then mark the position of the end of the gaiter on the driveshaft, using quick-drying paint (see illustrations).

4 Slide the rubber gaiter down the shaft, to expose the outer constant velocity joint then scoop out the excess grease (see illustration). It is advisable to wear disposable rubber gloves during this operation.

5 Hold the driveshaft and, using a mallet, sharply strike the edge of the outer joint to drive it off the end of the shaft (see illustration). The joint is retained on the driveshaft by a circlip, and striking the joint in this manner forces the circlip into its groove, so allowing the joint to slide off.

6 Once the joint assembly has been removed, remove the circlip from the groove in the

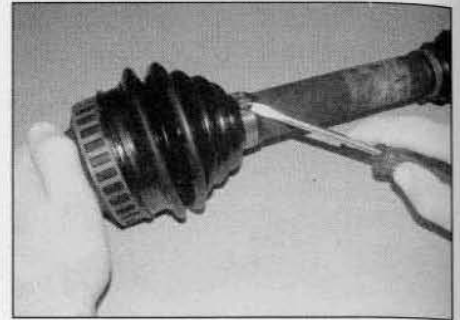

4.3a Release the inner retaining clip using a screwdriver . . .

driveshaft splines, and discard it (see illustration). A new circlip must be fitted on reassembly.

7 Withdraw the rubber gaiter from the driveshaft, and slide off the inner retaining clip.

8 With the constant velocity joint removed from the driveshaft, wipe away as much of the old grease as possible (do not use any solvent) to allow the joint components to be inspected.

9 Move the inner splined driving member from side-to-side, to expose each ball in turn at the top of its track. Examine the balls for cracks, flat spots, or signs of surface pitting.

10 Inspect the ball tracks on the inner and outer members. If the tracks have widened, the balls will no longer be a tight fit. At the same time, check the ball cage windows for wear or cracking between the windows.

11 If any of the constant velocity joint components are found to be worn or damaged, it will be necessary to renew the complete joint assembly (where available), or even the complete driveshaft (where no joint components are available separately). Refer to your Peugeot/Citroën dealer for further information on parts availability. If the joint is in satisfactory condition, obtain a repair kit consisting of a new gaiter, circlip, retaining clips, and the correct type and quantity of grease.

12 To install the new gaiter, perform the operations shown (see illustrations). Be sure to stay in order, and follow the captions carefully. Note that different types of gaiter retaining clips may be encountered, but the fitting procedures will be similar to those shown.



4.3b . . . then mark the position of the end of the gaiter on the driveshaft



4.4 Slide the gaiter down the shaft, then scoop out the excess grease



4.5 Sharply strike the edge of the outer joint to drive it off the end of the shaft



4.6 Remove the circlip from the groove in the driveshaft splines



4.12a Slide the new gaiter inner retaining clip on the driveshaft . . .



4.12b ... followed by the new gaiter with the outer retaining clip in place

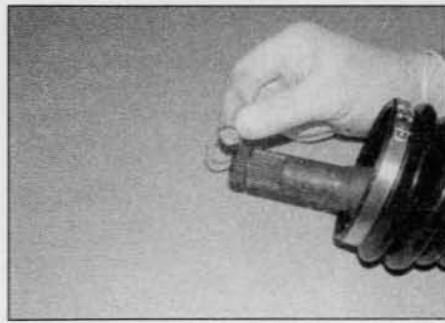

4.12c Locate a new circlip in the driveshaft groove ...

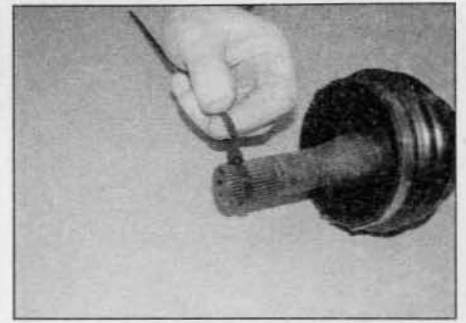

4.12d ... then compress the circlip using a cable tie

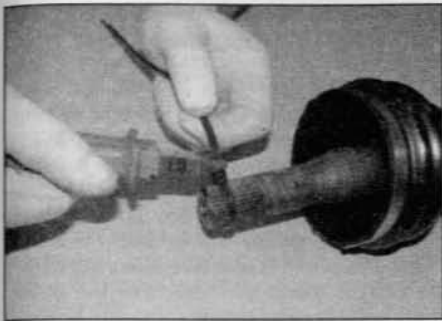

4.12e Use side-cutters to pull the cable tie as tight as possible, then cut off the end



4.12f Slide the CV joint onto the splines, and position the inner member up against the cable tie

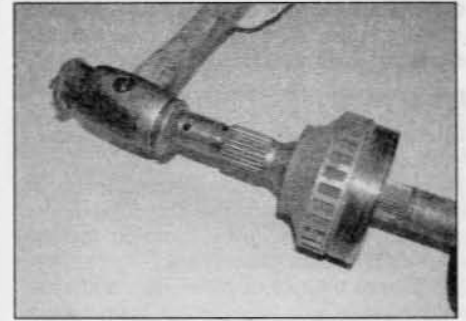

4.12g Strike the end of the joint sharply to displace the cable tie and force the inner member over the circlip

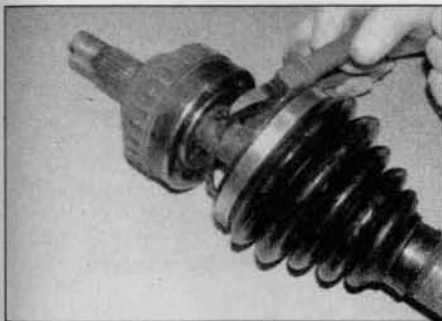

4.12h With the joint in place, cut off the cable tie



4.12i Pack the joint with half the recommended quantity of grease ...



4.12j ... working it well into the ball tracks while twisting the joint



4.12k Fill the gaiter with the remaining grease ...

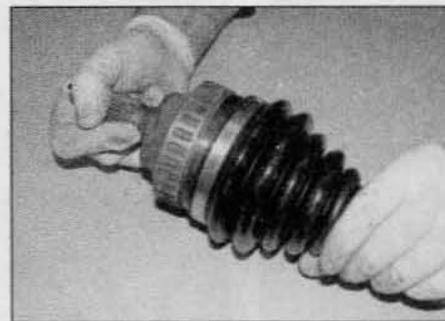

4.12l ... then slide the gaiter over the joint outer member, engaging it with the locating groove



4.12m Locate the gaiter inner end in the shaft groove or against the mark made on removal, slide the clip in place and compress the raised portion using pincers or side-cutters



4.12n Secure the gaiter outer retaining clip in the same way

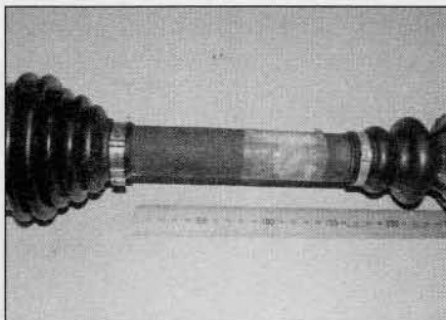

4.15 Measure and record the distance between the inner edges of the driveshaft inner and outer gaiters

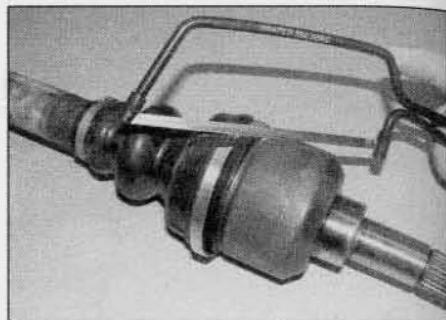

4.16 Release the gaiter retaining clips by cutting through them with a hacksaw

13 Check that the constant velocity joint moves freely in all directions, then refit the driveshaft as described in Section 2.

**Inner joint**

14 Remove the driveshaft as described in Section 2.

15 Measure the distance between the inner edges of the driveshaft inner and outer rubber gaiters and record this dimension for use when refitting (see illustration).

16 Release the rubber gaiter inner and outer retaining clips by cutting through them using a

junior hacksaw (see illustration). Spread the clips and remove them from the gaiter.

17 Withdraw the joint outer member from the tripod, and recover the spring and thrust cap from inside the outer member (see illustrations). As the outer member is withdrawn, check whether the tripod bearing rollers are staked to the tripod, or secured by circlips. If the rollers are not secured to the tripod, wrap adhesive tape around the rollers to hold them in position.

18 Wipe away as much of the excess grease as possible from the tripod and bearing rollers

(see illustration). It is advisable to wear disposable rubber gloves during this operation.

19 The tripod joint can now be removed using a two- or three-legged hydraulic bearing puller or a press. If a puller is being used, ensure that the legs of the puller are located behind the tripod, and not in contact with the joint rollers. If a press is being used, support the underside of the tripod, and press the driveshaft out of the joint (see illustration).

20 With the tripod removed, slide the gaiter off the end of the driveshaft.



4.17a Withdraw the joint outer member from the tripod . . .



4.17b . . . and recover the spring and thrust cap from inside the outer member

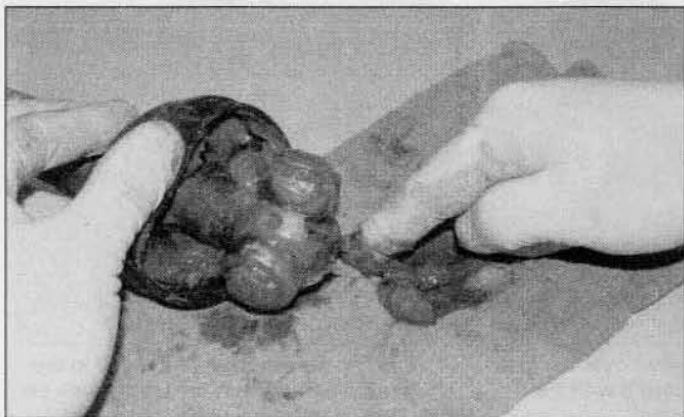

4.18 Wipe away as much grease as possible from the tripod and bearing rollers

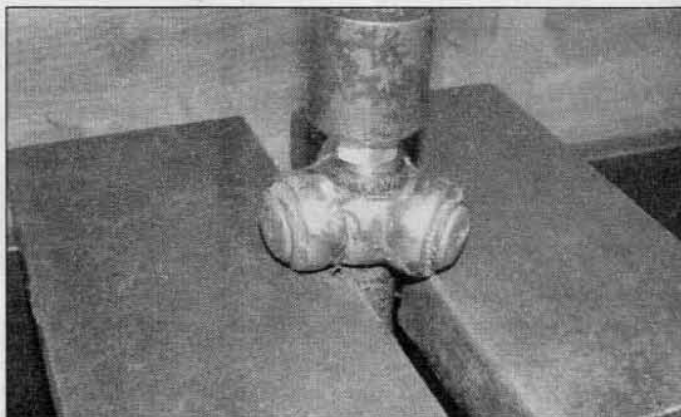

4.19 Remove the tripod using a two- or three-legged hydraulic bearing puller or a press





**4.22a** Slide the new inner retaining clip and the gaiter onto the driveshaft

**21** Wipe away as much of the old grease as possible (do not use any solvent) to allow the joint components to be inspected. Examine the tripod, bearing rollers and outer member for any signs of scoring or wear, and for smoothness of movement of the rollers on the tripod stems. If any of the components are found to be worn or damaged, it will be necessary to renew the complete joint assembly (where available), or even the complete driveshaft (where no joint components are available separately). Refer to your Peugeot/Citroën dealer for further information on parts availability. If the joint is in satisfactory condition, obtain a repair kit consisting of a new gaiter, retaining clips, and the correct type and quantity of grease.

**22** To install the new gaiter, perform the operations shown (see illustrations). Be sure



**4.22b** Mount the driveshaft in a vice, engage the tripod over the splines and tap it fully into position

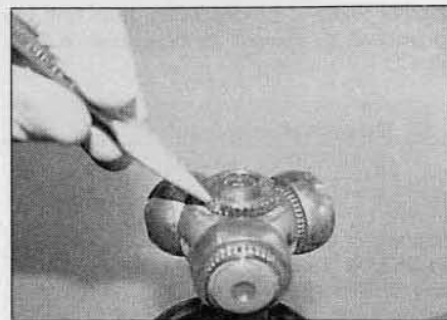

**4.22c** Using a small punch, stake the tripod to the driveshaft in three places

to stay in order, and follow the captions carefully. Note that different types of gaiter retaining clips may be encountered, but the

fitting procedures will be similar to those shown.

**23** Check that the constant velocity joint



**4.22d** Pack the tripod and the gaiter with half the recommended quantity of the grease . . .

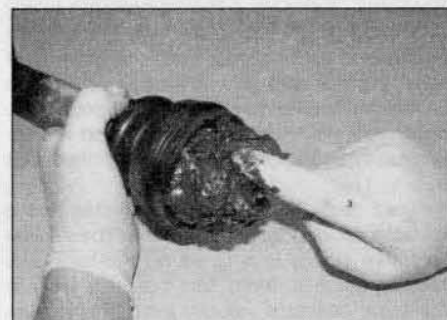

**4.22e** . . . working it well into the bearing rollers

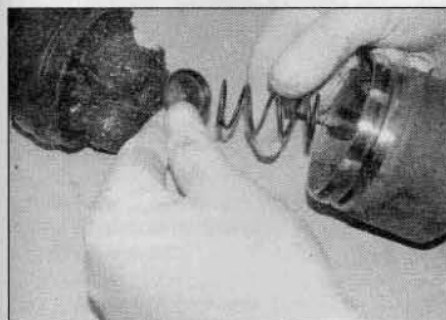

**4.22f** Refit the spring and thrust cap to the outer member . . .



**4.22g** . . . then pack the outer member with the remaining grease



**4.22h** Locate the outer member over the tripod and engage the gaiter with the outer member groove



**4.22i** Push the outer member fully into position over the tripod, while lifting the gaiter inner end to expel trapped air



**4.22j** Position the outer retaining clip over the gaiter and compress the raised portion using pincers or side-cutters

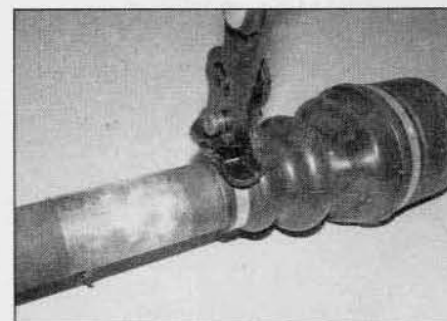

**4.22k** Position the gaiter inner end at the dimension recorded during removal, slip on the clip and compress the raised portion

moves freely in all directions, then refit the driveshaft to the car as described in Section 2.

### 5 Driveshaft overhaul – general information

**1** If any of the checks described in *Road test* in Chapter 1A or 1B reveal possible wear in any driveshaft joint, carry out the following procedures to identify the source of the problem.

**2** Firmly apply the handbrake, then jack up the front of the vehicle and support it securely on axle stands (see *Jacking and vehicle support*).

**3** Referring to the information contained in Section 2, make up a tool to hold the wheel hub, and bolt the tool to the hub. Remove the R-clip and locking cap from the driveshaft retaining nut and use a torque wrench to check that the nut is securely fastened. Once tightened, refit the locking cap and R-clip. Repeat this check on the remaining driveshaft nut.

**4** Road test the vehicle, and listen for a metallic clicking from the front as the vehicle is driven slowly in a circle on full-lock. If a clicking noise is heard, this indicates wear in the outer constant velocity joint. This means

that the joint must be renewed; reconditioning is not possible.

**5** If vibration, consistent with road speed, is felt through the car when accelerating, there is a possibility of wear in the inner constant velocity joints.

**6** To check the joints for wear, remove the driveshafts, then dismantle them; if any wear or free play is found, the affected joint must be renewed. In most cases this will mean that the complete driveshaft assembly must be renewed, if the joints are not available separately. Refer to your Peugeot/Citroën dealer for information on the availability of driveshaft components.

### 6 Right-hand driveshaft intermediate bearing – renewal



**Note:** A suitable bearing puller will be required, to draw the bearing and collar off the driveshaft end.

**1** Remove the right-hand driveshaft as described in Section 2.

**2** Check that the bearing outer race rotates smoothly and easily, without any signs of roughness or undue free play between the inner and outer races. If necessary, renew the bearing as follows.

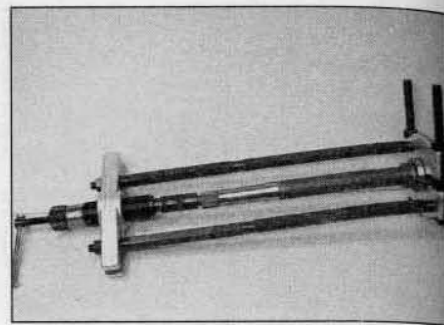

**6.3** Using a long-reach bearing puller to remove the intermediate bearing from the right-hand driveshaft

**3** Using a long-reach universal bearing puller, carefully draw the collar and intermediate bearing off the driveshaft inner end (see *illustration*). Apply a smear of grease to the inner race of the new bearing, then fit the bearing over the end of the driveshaft. Using a hammer and suitable piece of tubing which bears only on the bearing inner race, tap the new bearing into position on the driveshaft, until it abuts the constant velocity joint outer member. Once the bearing is correctly positioned, tap the bearing collar onto the shaft until it contacts the bearing inner race.

**4** Check that the bearing rotates freely, then refit the driveshaft as described in Section 2.

# Chapter 9

## Braking system

### Contents

Section number	Section number		
Anti-lock braking system (ABS) – general information . . . . .	19	Hydraulic pipes and hoses – renewal . . . . .	3
Anti-lock braking system (ABS) components – removal and refitting . . . . .	20	Hydraulic system – bleeding . . . . .	2
Brake fluid level check . . . . . See <i>Weekly checks</i>		Master cylinder – removal, overhaul and refitting . . . . .	10
Brake fluid renewal . . . . . See Chapter 1A or 1B		Rear brake drum – removal, inspection and refitting . . . . .	7
Front brake caliper – removal, overhaul and refitting . . . . .	8	Rear brake pressure-regulating valve – removal and refitting . . . . .	16
Front brake disc – inspection, removal and refitting . . . . .	6	Rear brake shoe wear check . . . . . See Chapter 1A or 1B	
Front brake pad wear check . . . . . See Chapter 1A or 1B		Rear brake shoes – renewal . . . . .	5
Front brake pads – renewal . . . . .	4	Rear wheel cylinder – removal and refitting . . . . .	9
General information . . . . .	1	Stop-light switch – removal, refitting and adjustment . . . . .	17
Handbrake – adjustment . . . . .	13	Vacuum pump (diesel engine models) – removal and refitting . . . . .	21
Handbrake 'on' warning light switch – removal and refitting . . . . .	18	Vacuum pump (diesel engine models) – testing and overhaul . . . . .	22
Handbrake cables – removal and refitting . . . . .	15	Vacuum servo unit – testing, removal and refitting . . . . .	11
Handbrake lever – removal and refitting . . . . .	14	Vacuum servo unit check valve – removal, testing and refitting . . . . .	12

### Degrees of difficulty

**Easy**, suitable for novice with little experience



**Fairly easy**, suitable for beginner with some experience



**Fairly difficult**, suitable for competent DIY mechanic



**Difficult**, suitable for experienced DIY mechanic



**Very difficult**, suitable for expert DIY or professional



### Specifications

#### Front disc brakes

Caliper type:	
Up to 2002 . . . . .	Lucas C54
2002 onward . . . . .	Bosch ZOH 54
Disc diameter . . . . .	266.0 mm
Disc thickness:	
Solid disc:	
New . . . . .	13.0 mm
Minimum thickness . . . . .	11.0 mm
Ventilated disc:	
Up to 2002:	
New . . . . .	20.4 mm
Minimum thickness . . . . .	18.4 mm
2002 onward:	
New . . . . .	22.0 mm
Minimum thickness . . . . .	20.0 mm
Maximum disc run-out . . . . .	0.1 mm
Brake pad minimum thickness . . . . .	2.0 mm

#### Rear drum brakes

Drum internal diameter:	
New . . . . .	228.0 mm
Maximum after machining . . . . .	230.0 mm
Brake shoe minimum thickness . . . . .	1.5 mm

#### Torque wrench settings

	Nm	lbf ft
ABS hydraulic modulator retaining nuts . . . . .	15	11
ABS wheel sensor retaining bolts* . . . . .	11	8
Front brake caliper guide pin bolts* . . . . .	27	20
Front brake caliper mounting bracket-to-swivel hub bolts* . . . . .	105	77
Master cylinder-to-servo unit nuts . . . . .	20	15
Rear brake pressure-regulating valve mounting bolt . . . . .	30	22
Roadwheel bolts . . . . .	90	66
Vacuum pump retaining nuts/bolts (diesel engine models) . . . . .	25	18
Vacuum servo unit mounting nuts . . . . .	23	17

\* Use thread-locking compound



## 1 General information

The braking system is of the servo-assisted, dual-circuit hydraulic type. The arrangement of the hydraulic system is such that each circuit operates one front and one rear brake from a tandem master cylinder. Under normal circumstances, both circuits operate in unison. However, in the event of hydraulic failure in one circuit, full braking force will still be available at two wheels.

All models are fitted with either solid or ventilated front disc brakes and self-adjusting rear drum brakes. An Anti-lock Braking System (ABS) is fitted as standard or available as an option, according to model (refer to Section 19 for further information on ABS operation).

The front disc brakes are actuated by single-piston sliding type calipers, which ensure that equal pressure is applied to each disc pad.

The rear drum brakes incorporate leading and trailing shoes, which are actuated by twin-piston wheel cylinders. A self-adjusting mechanism is incorporated, to automatically compensate for brake shoe wear. As the brake shoe linings wear, the footbrake operation automatically operates the adjuster mechanism, which effectively lengthens the shoe strut and repositions the brake shoes, to reduce the lining-to-drum clearance.

To prevent rear wheel lock-up during emergency braking, a load-sensitive pressure-regulating valve assembly is fitted into the hydraulic circuit to each rear brake. The valve is mounted on the underside of the vehicle at the rear and is attached to the rear suspension by means of an operating rod and spring. The valve measures the load on the rear of the vehicle via the movement of the rear suspension and regulates the hydraulic pressure applied to the rear brakes accordingly. On later models (approximately 2001 onward) equipped with ABS, the hydraulic pressure applied to the rear brakes is regulated by the ABS hydraulic modulator under all braking conditions. On these models, the separate mechanical pressure-regulating valve assembly is not used.

On all models, the handbrake provides an independent mechanical means of rear brake application.

On diesel engine models, there is insufficient vacuum in the inlet manifold to operate the braking system servo effectively at all times. To overcome this problem, a vacuum pump is fitted to the engine, to provide sufficient vacuum to operate the servo unit. The vacuum pump is mounted on the left-hand end of the cylinder head, and driven directly off the end of the camshaft.

**Note:** When servicing any part of the system, work carefully and methodically; also observe scrupulous cleanliness when overhauling any

part of the hydraulic system. Always renew components (in axle sets, where applicable) if in doubt about their condition, and use only genuine Peugeot/Citroën parts, or at least those of known good quality. Note the warnings given in 'Safety first!' and at relevant points in this Chapter concerning the dangers of asbestos dust and brake hydraulic fluid.

## 2 Hydraulic system – bleeding



**Warning:** Brake hydraulic fluid is poisonous; wash off immediately and thoroughly in the case of skin contact, and seek immediate medical advice if any fluid is swallowed or gets into the eyes. Certain types of hydraulic fluid are inflammable, and may ignite when allowed into contact with hot components; when servicing any hydraulic system, it is safest to assume that the fluid is inflammable, and to take precautions against the risk of fire as though it is petrol that is being handled. Hydraulic fluid is also an effective paint stripper, and will attack plastics; if any is spilt, it should be washed off immediately, using copious quantities of fresh water. Finally, it is hygroscopic (it absorbs moisture from the air) – old fluid may be contaminated and unfit for further use. When topping-up or renewing the fluid, always use the recommended type, and ensure that it comes from a freshly-opened sealed container.

### Models without ABS

#### General

1 The correct operation of any hydraulic system is only possible after removing all air from the components and circuit; this is achieved by bleeding the system.

2 During the bleeding procedure, add only clean, unused hydraulic fluid of the recommended type (see *Lubricants and fluids*); never re-use fluid that has already been bled from the system. Ensure that sufficient fluid is available before starting work.

3 If there is any possibility of incorrect fluid being already in the system, the brake components and circuit must be flushed completely with uncontaminated, correct fluid, and new seals should be fitted to the various components.

4 If hydraulic fluid has been lost from the system, or air has entered because of a leak, ensure that the fault is cured before proceeding further.

5 Park the vehicle on level ground, switch off the engine and select first or reverse gear, then chock the wheels and release the handbrake.

6 Check that all pipes and hoses are secure, unions tight and bleed screws closed. Clean any dirt from around the bleed screws.

7 Unscrew the master cylinder reservoir cap, and top the master cylinder reservoir up to the MAX level line; refit the cap loosely, and remember to maintain the fluid level above the MIN level line throughout the procedure, or there is a risk of further air entering the system.

8 There is a number of one-man, do-it-yourself brake bleeding kits currently available from motor accessory shops. It is recommended that one of these kits is used whenever possible, as they greatly simplify the bleeding operation, and also reduce the risk of expelled air and fluid being drawn back into the system. If such a kit is not available, the basic (two-man) method must be used, which is described in detail below.

9 If a kit is to be used, prepare the vehicle as described previously, and follow the kit manufacturer's instructions, as the procedure may vary slightly according to the type being used; generally, they are as outlined below in the relevant sub-section.

10 Whichever method is used, the same sequence must be followed (paragraphs 11 and 12) to ensure the removal of all air from the system.

#### Bleeding sequence

11 If the system has been only partially disconnected, and suitable precautions were taken to minimise fluid loss, it should be necessary only to bleed that part of the system (ie, the primary or secondary circuit).

12 If the complete system is to be bled, then it should be done working in the following sequence:

- a) Right-hand rear brake.
- b) Left-hand rear brake.
- c) Right-hand front brake.
- d) Left-hand front brake.

#### Basic (two-man) method

13 Collect a clean glass jar, a suitable length of plastic or rubber tubing which is a tight fit over the bleed screw, and a ring spanner to fit the screw. The help of an assistant will also be required.

14 Remove the dust cap from the first screw in the sequence. Fit the spanner and tube to the screw, place the other end of the tube in the jar, and pour in sufficient fluid to cover the end of the tube.

15 Ensure that the master cylinder reservoir fluid level is maintained above the MIN level line throughout the procedure.

16 Have the assistant fully depress the brake pedal several times to build-up pressure, then maintain it on the final downstroke.

17 While pedal pressure is maintained, unscrew the bleed screw (approximately one turn) and allow the compressed fluid and air to flow into the jar. The assistant should maintain pedal pressure, following it down to the floor if necessary, and should not release it until instructed to do so. When the flow stops, tighten the bleed screw again, have the assistant release the pedal slowly, and recheck the reservoir fluid level.

18 Repeat the steps given in paragraphs 16 and 17 until the fluid emerging from the bleed screw is free from air bubbles. If the master cylinder has been drained and refilled, and air is being bled from the first screw in the sequence, allow approximately five seconds between cycles for the master cylinder passages to refill.

19 When no more air bubbles appear, tighten the bleed screw securely, remove the tube and spanner, and refit the dust cap. Do not overtighten the bleed screw.

20 Repeat the procedure on the remaining screws in the sequence, until all air is removed from the system and the brake pedal feels firm again.

#### Using a one-way valve kit

21 As their name implies, these kits consist of a length of tubing with a one-way valve fitted, to prevent expelled air and fluid being drawn back into the system; some kits include a translucent container, which can be positioned so that the air bubbles can be more easily seen flowing from the end of the tube.

22 The kit is connected to the bleed screw, which is then opened. The user returns to the driver's seat, depresses the brake pedal with a smooth, steady stroke, and slowly releases it; this is repeated until the expelled fluid is clear of air bubbles.

23 Note that these kits simplify work so much that it is easy to forget the master cylinder reservoir fluid level; ensure that this is maintained above the MIN level line at all times.

#### Using a pressure-bleeding kit

24 These kits are usually operated by the reservoir of pressurised air contained in the spare tyre. However, note that it will probably be necessary to reduce the pressure to a lower level than normal; refer to the instructions supplied with the kit.

25 By connecting a pressurised, fluid-filled container to the master cylinder reservoir, bleeding can be carried out simply by opening each screw in turn (in the specified sequence), and allowing the fluid to flow out until no more air bubbles can be seen in the expelled fluid.

26 This method has the advantage that the large reservoir of fluid provides an additional safeguard against air being drawn into the system during bleeding.

27 Pressure-bleeding is particularly effective when bleeding 'difficult' systems, or when bleeding the complete system at the time of routine fluid renewal.

#### All methods

28 When bleeding is complete, and firm pedal feel is restored, wash off any spilt fluid, tighten the bleed screws, and refit their dust caps.

29 Check the hydraulic fluid level in the master cylinder reservoir, and top-up if necessary.

30 Discard any fluid that has been bled from

the system; it will not be fit for re-use.

31 Check the feel of the brake pedal. If it feels at all spongy, air must still be present in the system, and further bleeding is required. Failure to bleed properly after a reasonable repetition of the bleeding procedure may be due to worn master cylinder seals.

#### Models with ABS



**Warning: On models equipped with ABS, ensure that the ignition is switched off before starting the bleeding procedure, to avoid any possibility of voltage being applied to the hydraulic modulator before the bleeding procedure is completed. Ideally, the battery should be disconnected. If voltage is applied to the modulator before the bleeding procedure is complete, this will effectively drain the hydraulic fluid in the modulator, rendering the unit unserviceable. Do not, therefore, attempt to 'run' the modulator in order to bleed the brakes.**

32 A pressure-bleeding kit must be used for bleeding the hydraulic system on ABS models – see paragraphs 24 to 27.

33 Following the sequence given in paragraph 12, bleed each brake in turn until clean fluid, free of air bubbles, is seen to emerge. Pause between bleeding each brake to ensure that the fluid level in the reservoir is above the MIN level.

34 When bleeding is complete, and firm pedal feel is restored, wash off any spilt fluid, tighten the bleed screws, and refit their dust caps.

35 Check the hydraulic fluid level in the master cylinder reservoir, and top-up if necessary.

36 Discard any fluid that has been bled from the system; it will not be fit for re-use.

37 Check the feel of the brake pedal. If it feels at all spongy, air must still be present in the system, and further bleeding is required.



**Warning: Do not operate the vehicle if you are in doubt about the effectiveness of the braking system. If considerable air was present in the system prior to bleeding, it is possible for some of this air to remain trapped in the hydraulic modulator assembly. If the pedal continues to feel spongy after repeated bleedings, or if any of the brake system warning lights remain on, have the vehicle towed to a Peugeot/Citroën dealer to be bled with the use of Peugeot/Citroën diagnostic equipment.**

#### 3 Hydraulic pipes and hoses – renewal

**Note: Before starting work, refer to the note at the beginning of Section 2 concerning the dangers of hydraulic fluid.**

1 If any pipe or hose is to be renewed, minimise fluid loss by first removing the master cylinder reservoir cap, then tightening it down onto a piece of polythene to obtain an airtight seal. Alternatively, flexible hoses can be sealed, if required, using a proprietary brake hose clamp; metal brake pipe unions can be plugged (if care is taken not to allow dirt into the system) or capped immediately they are disconnected. Place a wad of rag under any union that is to be disconnected, to catch any spilt fluid.

2 If a flexible hose is to be disconnected, unscrew the brake pipe union nut before removing the spring clip which secures the hose to its mounting bracket.

3 To unscrew the union nuts, it is preferable to obtain a brake pipe spanner of the correct size; these are available from most large motor accessory shops. Failing this, a close-fitting open-ended spanner will be required, though if the nuts are tight or corroded, their flats may be rounded-off if the spanner slips. In such a case, a self-locking wrench is often the only way to unscrew a stubborn union, but it follows that the pipe and the damaged nuts must be renewed on reassembly. Always clean a union and surrounding area before disconnecting it. If disconnecting a component with more than one union, make a careful note of the connections before disturbing any of them.

4 If a brake pipe is to be renewed, it can be obtained, cut to length and with the union nuts and end flares in place, from Peugeot/Citroën dealers. All that is then necessary is to bend it to shape, following the line of the original, before fitting it to the car. Alternatively, most motor accessory shops can make up brake pipes from kits, but this requires very careful measurement of the original, to ensure that the new one is of the correct length. The safest answer is usually to take the original to the shop as a pattern.

5 On refitting, do not overtighten the union nuts. It is not necessary to exercise brute force to obtain a sound joint.

6 Ensure that the pipes and hoses are correctly routed, with no kinks, and that they are secured in the clips or brackets provided. After fitting, remove the polythene from the reservoir, and bleed the hydraulic system as described in Section 2. Wash off any spilt fluid, and check carefully for fluid leaks.

#### 4 Front brake pads – renewal



**Warning: Renew BOTH sets of front brake pads at the same time – NEVER renew the pads on only one wheel, as uneven braking may result. Note that the dust created by wear of the pads may contain asbestos, which is a health hazard. Never blow it out with compressed air, and don't**



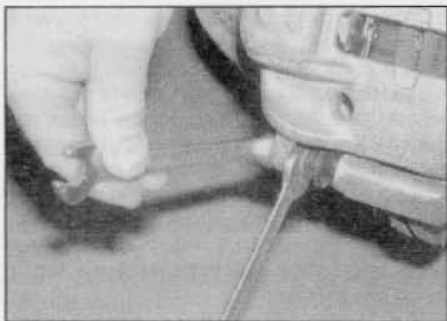

4.4 Retain the guide pin with a spanner while undoing the lower guide pin bolt



4.5 Slacken the upper guide pin bolt, and pivot the caliper upwards off the brake pads

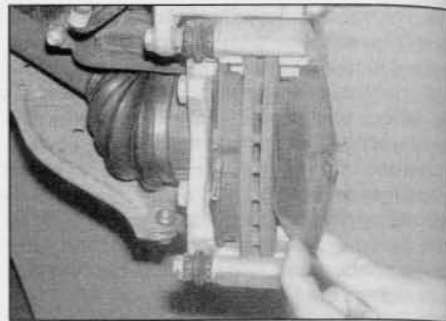

4.6 Withdraw the two brake pads from the caliper mounting bracket

*inhale any of it. An approved filtering mask should be worn when working on the brakes. DO NOT use petrol or petroleum-based solvents to clean brake parts; use brake cleaner or methylated spirit only.*  
**Note:** New guide pin bolts must be used on refitting.

**Lucas caliper**

- 1 Apply the handbrake, then jack up the front of the vehicle and support it on axle stands (see *Jacking and vehicle support*). Remove the front roadwheels.
- 2 Disconnect the brake pad wear sensor wiring at the connector on the swivel hub. Note the routing of the wires, and free them from any relevant retaining clips.
- 3 Push the piston into its bore by pulling the caliper outwards.
- 4 Undo and remove the lower caliper guide pin bolt, using a second, slim, open-ended spanner to prevent the guide pin itself from rotating (see *illustration*). Discard the guide pin bolt – new bolts must be used on refitting.
- 5 Slacken the upper guide pin bolt, while holding the guide pin with the open-ended spanner as before. Pivot the caliper upwards off the brake pads, and tie the caliper to the suspension strut to hold it in this position (see *illustration*).
- 6 Withdraw the two brake pads from the caliper mounting bracket noting their fitted positions if they are to be re-used (ie, inner and outer) (see *illustration*).
- 7 First measure the thickness of each brake pad's friction material. If either pad is worn at

- any point to the specified minimum thickness or less, all four pads must be renewed (see *illustration*). Also, the pads should be renewed if any are fouled with oil or grease; there is no satisfactory way of degreasing friction material, once contaminated. If any of the brake pads are worn unevenly, or are fouled with oil or grease, trace and rectify the cause before reassembly. New brake pads and repair kits are available from Peugeot/Citroën dealers.
- 8 If the brake pads are still serviceable, carefully clean them using a clean, fine wire brush or similar, paying particular attention to the sides and back of the metal backing. Clean out the grooves in the friction material, and pick out any large embedded particles of dirt or debris. Carefully clean the pad locations in the caliper mounting bracket.
  - 9 Prior to fitting the pads, check that the guide pins are free to slide easily in the caliper body/mounting bracket, and check that the rubber guide pin gaiters are undamaged. Brush the dust and dirt from the caliper and piston, but do not inhale it, as it is injurious to health. Inspect the dust seal around the piston for damage, and the piston for evidence of fluid leaks, corrosion or damage. If attention to any of these components is necessary, refer to Section 8.
  - 10 If new brake pads are to be fitted, the caliper piston must be pushed back into the cylinder to make room for them; either use a G-clamp or similar tool, or use suitable pieces of wood as levers. Clamp off the flexible brake hose leading to the caliper then connect a brake bleeding kit to the caliper bleed nipple. Open the bleed nipple as the piston is

- retracted, the surplus brake fluid will then be collected in the bleed kit vessel (see *illustrations*). Close the bleed nipple just before the caliper piston is pushed fully into the caliper. This should ensure no air enters the hydraulic system. **Note:** The ABS modulator contains hydraulic components that are very sensitive to impurities in the brake fluid. Even the smallest particles can cause the system to fail through blockage. The pad retraction method described here prevents any debris in the brake fluid expelled from the caliper from being passed back to the ABS modulator, as well as preventing any chance of damage to the master cylinder seals.
- 11 Install the pads in the caliper mounting bracket, ensuring that the friction material of each pad is against the brake disc, and that the pads are in their correct locations if the original pads are being re-used. Where new pads are being fitted, the pad with the white wear sensor wire should be on the outside.
  - 12 Pivot the caliper down over the pads, and pass the pad wear sensor wiring through the caliper aperture.
  - 13 If not already pre-coated, apply suitable thread locking compound to the threads of the two new guide pin bolts. Insert the lower bolt and tighten it to the specified torque. Hold the guide pin with the open-ended spanner as the guide pin bolt is tightened.
  - 14 Remove the original upper guide pin bolt and fit the new bolt, tightening it to the specified torque.
  - 15 Reconnect the brake pad wear sensor wiring connectors, ensuring that the wiring is

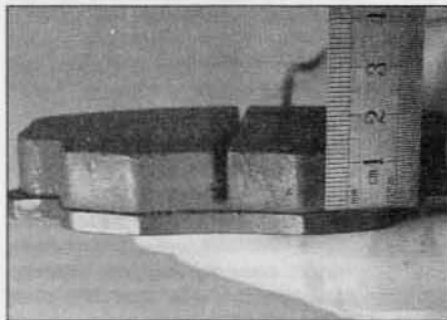

4.7 Measuring brake pad friction material thickness



4.10a Use a suitable tool to retract the caliper piston . . .

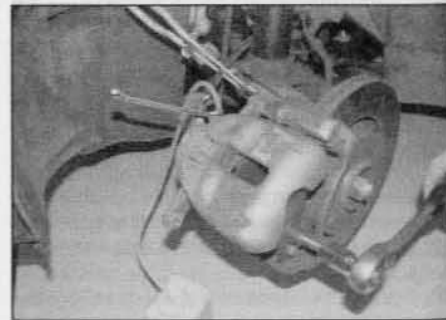

4.10b . . . and with the bleed nipple open, collect the expelled fluid in a container



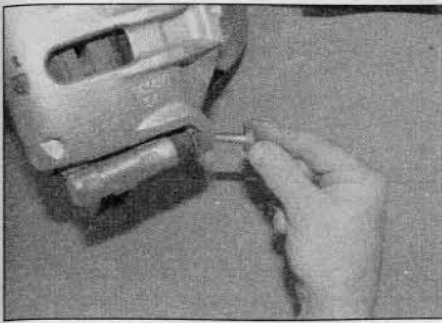

4.20 Undo and remove the lower caliper guide pin bolt . . .

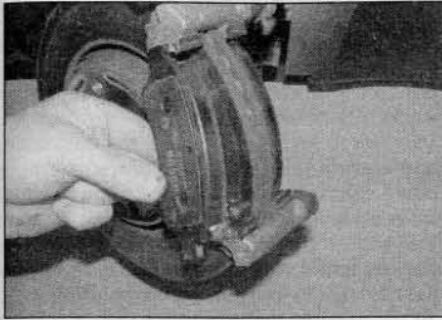

4.22a Withdraw the brake pads from the caliper mounting bracket . . .

correctly routed through the loop of the caliper bleed screw cap.

16 Depress the brake pedal repeatedly, until the pads are pressed into firm contact with the brake disc, and normal (non-assisted) pedal pressure is restored.

17 Repeat the above procedure on the remaining front brake caliper.

### Bosch caliper

18 Apply the handbrake, then jack up the front of the vehicle and support it on axle stands (see *Jacking and vehicle support*). Remove the front roadwheels.

19 Push the piston into its bore by pulling the caliper outwards.

20 Undo and remove the lower caliper guide pin bolt (see illustration). Discard the guide pin bolt – a new bolt must be used on refitting.

21 Pivot the caliper upwards off the brake pads, and tie the caliper to the suspension strut to hold it in this position (see illustration).

22 Withdraw the two brake pads from the caliper mounting bracket noting their fitted positions if they are to be re-used (ie, inner and outer). Recover the shims from the top and bottom of the caliper mounting bracket (see illustrations).

23 Proceed as described in paragraphs 7 to 10.

24 Refit the shims to the top and bottom of the caliper mounting bracket, ensuring they are correctly located.

25 Install the pads in the caliper mounting bracket, ensuring that the friction material of each pad is against the brake disc, and that the pads are in their correct locations if the original pads are being re-used.

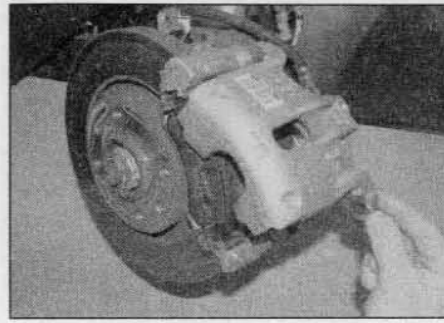

4.21 . . . then pivot the caliper upwards off the brake pads

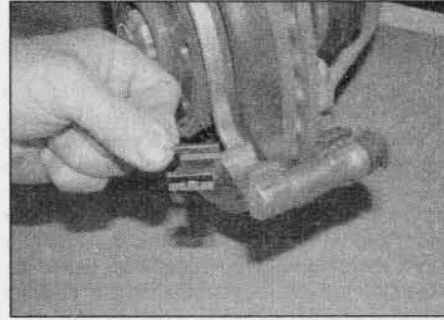

4.22b . . . then recover the top and bottom shims

26 Untie the caliper piston and carefully pivot it back down over the pads. Position the flat on the lower guide pin horizontally to allow the machined face on the caliper mounting lug to correctly engage (see illustration).

27 If not pre-coated, apply suitable thread locking compound to the threads of the new lower guide pin bolt. Insert the bolt and tighten it to the specified torque.

28 Depress the brake pedal repeatedly, until the pads are pressed into firm contact with the brake disc, and normal (non-assisted) pedal pressure is restored.

29 Repeat the above procedure on the remaining front brake caliper.

### All calipers

30 Refit the roadwheels, then lower the vehicle to the ground and tighten the roadwheel bolts to the specified torque.

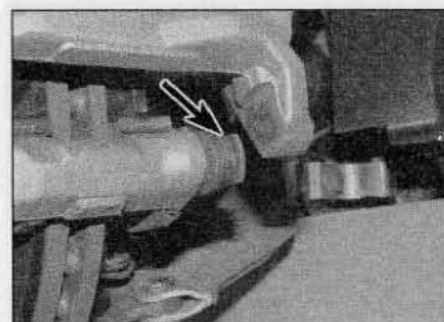

4.26 Position the flat (arrowed) on the guide pin horizontally to allow the caliper mounting lug to correctly engage

31 Finally, check the hydraulic fluid level in the master cylinder reservoir as described in *Weekly checks*.

32 Note that new pads will not give full braking efficiency until they have bedded-in. Be prepared for this, and avoid hard braking as far as possible for the first hundred miles or so after pad renewal.

## 5 Rear brake shoes – renewal



**Warning:** Brake shoes must be renewed on **BOTH** rear wheels at the same time – **NEVER** renew the shoes on only one wheel, as uneven braking may result. Also, the dust created by wear of the shoes may contain asbestos, which is a health hazard. Never blow it out with compressed air, and don't inhale any of it. An approved filtering mask should be worn when working on the brakes. **DO NOT** use petrol or petroleum-based solvents to clean brake parts; use brake cleaner or methylated spirit only.

1 Remove the brake drum as described in Section 7.

2 Working carefully, and taking the necessary precautions, remove all traces of brake dust from the brake drum, backplate and shoes.

3 Measure the thickness of the friction material of each brake shoe at several points; if either shoe is worn at any point to the specified minimum thickness or less, all four shoes must be renewed as a set. The shoes should also be renewed if any are fouled with oil or grease; there is no satisfactory way of degreasing friction material, once contaminated.

4 If any of the brake shoes are worn unevenly, or fouled with oil or grease, trace and rectify the cause before reassembly.

5 Make a note of the correct fitted positions of the springs and adjuster strut, to use as a guide on reassembly.

6 Disengage the end of the lower return spring from the trailing shoe, unhook it from the leading shoe and lift out the spring (see illustration).

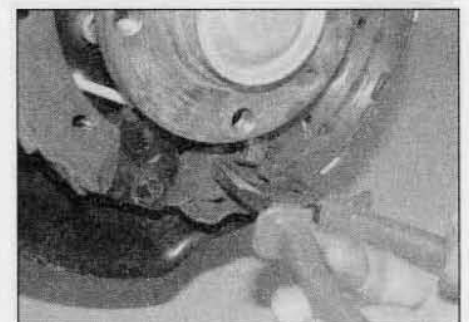

5.6 Disengage the lower return spring from the trailing shoe, unhook it from the leading shoe and lift out the spring

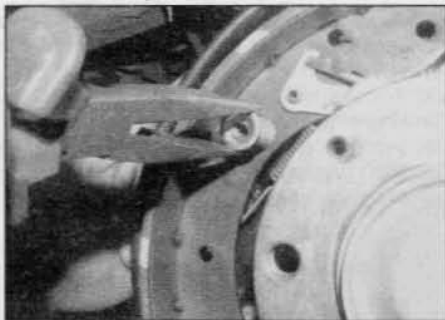

**5.7a** Depress the retainer spring cup and turn it through 90°, while holding the retainer pin from the rear of the backplate

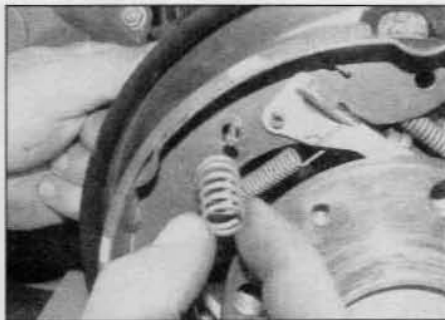

**5.7b** With the cup removed, lift off the spring, then withdraw the retainer pin

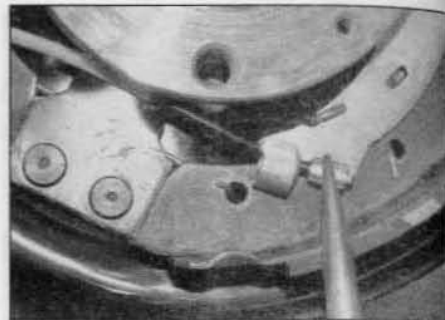

**5.8** Detach the handbrake cable end from the lever on the trailing shoe

**7** Using pliers, depress the leading shoe retainer spring cup and turn it through 90°, while holding the retainer pin with your finger from the rear of the backplate. With the cup removed, lift off the spring, then withdraw the retainer pin (see illustrations). Repeat this procedure for the retainer on the trailing shoe.

**8** Detach the handbrake cable end from the lever on the trailing shoe (see illustration).

**9** Disconnect the adjuster lever spring from the leading shoe and adjuster lever, then withdraw the adjuster lever (see illustrations).

**10** Lift the brake shoes off the lower pivot post and off the wheel cylinder pistons. Spread the shoes apart at the bottom and

remove the adjuster strut, upper return spring and then the two brake shoes.

**11** With the brake shoes removed, retain the wheel cylinder pistons in the wheel cylinder using a cable tie or a strong elastic band. Do not depress the brake pedal until the brakes are reassembled.

**12** Withdraw the forked end from the adjuster strut, and carefully examine the assembly for signs of wear or damage. Pay particular attention to the threads and the knurled adjuster wheel, and renew if necessary.

**13** Check the condition of all return springs and renew any that show signs of distortion or other damage.

**14** Peel back the rubber protective caps, and check the wheel cylinder for fluid leaks or

other damage; check that both cylinder pistons are free to move easily. Refer to Section 9, if necessary, for information on wheel cylinder renewal.

**15** Prior to installation, clean the backplate, and apply a thin smear of high-temperature brake grease or anti-seize compound to all those surfaces of the backplate which bear on the shoes, particularly the wheel cylinder pistons and lower pivot point. Do not allow the lubricant to foul the friction material.

**16** Ensure that the handbrake lever stop-peg is correctly located against the edge of the trailing shoe, and that the return spring is in position.

**17** Fit the upper return spring to its location in the leading and trailing brake shoes (see illustration).

**18** Screw in the adjuster wheel until the minimum strut length is obtained, then engage the strut with the leading shoe and handbrake lever (see illustration).

**19** Undo the two bolts securing the wheel cylinder to the brake backplate. Carefully ease the cylinder from its location until the bleed screw is clear of the backplate. Move the cylinder upwards as far as the hydraulic pipe will allow, to provide as much clearance between the cylinder and wheel hub as possible.

**20** Manoeuvre the partially assembled brake shoe assembly into position on the backplate, and engage the brake shoes with the wheel cylinder pistons (see illustration).

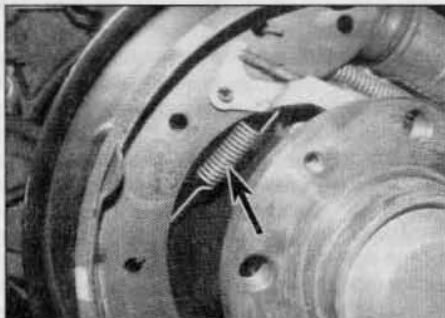

**5.9a** Disconnect the adjuster lever spring (arrowed) . . .

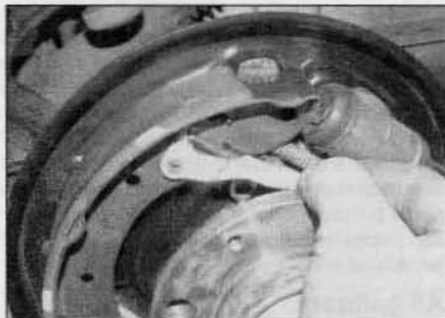

**5.9b** . . . then withdraw the adjuster lever

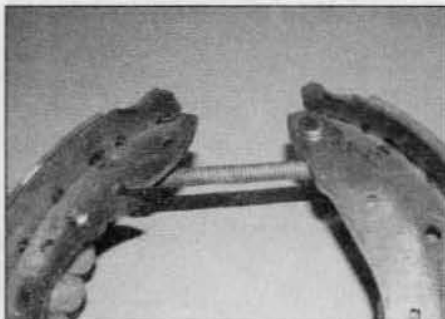

**5.17** Fit the upper return spring to the leading and trailing brake shoes



**5.18** Engage the adjuster strut with the leading shoe and handbrake lever



**5.20** Manoeuvre the partially assembled brake shoe assembly into position on the backplate



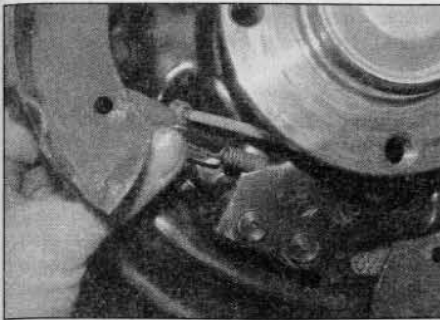

5.21 Feed the lower return spring behind the pivot post and connect one end to the leading shoe

21 Feed the lower return spring behind the lower pivot post and connect one end to the leading brake shoe (see illustration).

22 Hold the spring in place on the leading shoe and engage a screwdriver with the other end of the spring (see illustration).

23 Pull the spring by means of the screwdriver until it just catches on the edge of its locating hole in the trailing shoe. Now engage the tip of the screwdriver with the end of the spring and pull it fully into place (see illustration). Be prepared to have several attempts at this as there is very little working clearance behind the trailing shoe. Extreme patience is necessary!

24 Once the lower spring is connected, locate the brake shoes on the lower pivot post and at the same time ease the wheel cylinder back into its location. Refit the wheel cylinder retaining bolts and tighten them securely (see illustration).

25 Position the adjuster lever on the leading shoe, ensuring that it locates behind the forked end of the adjuster strut. Reconnect the adjuster lever spring to the lever and leading shoe (see illustration).

26 Reconnect the handbrake cable end to the handbrake lever on the trailing shoe.

27 Insert the leading brake shoe retainer pin through the backplate and place the spring on the pin. Hold the pin from behind, refit the cup and turn it through 90°. Repeat this procedure for the retainer on the trailing shoe, then tap the shoes to centralise them with the backplate.

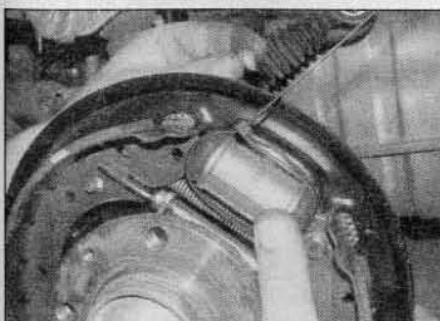

5.24 Locate the brake shoes on the lower pivot post and ease the wheel cylinder back into its location

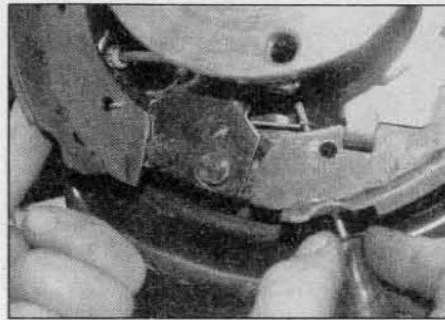

5.22 Hold the spring on the leading shoe and engage a screwdriver with the other end of the spring

28 Using a screwdriver, turn the strut adjuster wheel to expand the shoes until the brake drum just slides over the shoes.

29 Refit the brake drum as described in Section 7.

30 Repeat the above procedure on the remaining rear brake.

31 Once both sets of rear shoes have been renewed, adjust the lining-to-drum clearance by repeatedly depressing the brake pedal. Whilst depressing the pedal, have an assistant listen to the rear drums, to check that the adjuster strut is functioning correctly; if so, a clicking sound will be emitted by the strut as the pedal is depressed.

32 Check and, if necessary, adjust the handbrake as described in Section 13.

33 On completion, check the hydraulic fluid level in the master cylinder as described in *Weekly checks*.

34 Note that new shoes will not give full braking efficiency until they have bedded-in. Be prepared for this, and avoid hard braking as far as possible for the first hundred miles or so after shoe renewal.

## 6 Front brake disc – inspection, removal and refitting

**Note:** Before starting work, refer to the note at the beginning of Section 4 concerning the dangers of asbestos dust.

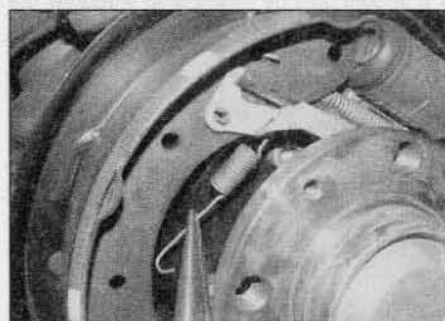

5.25 Position the adjuster lever on the leading shoe and reconnect the spring

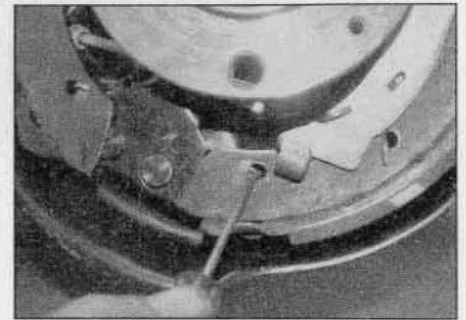

5.23 Pull the spring until it catches on its locating hole, then pull it fully into place with the tip of a screwdriver

## Inspection

**Note:** If either disc requires renewal, BOTH should be renewed at the same time, to ensure even and consistent braking. New brake pads should also be fitted.

1 Apply the handbrake, then jack up the front of the car and support it on axle stands (see *Jacking and vehicle support*). Remove the appropriate front roadwheel.

2 Slowly rotate the brake disc so that the full area of both sides can be checked; remove the brake pads if better access is required to the inboard surface. Light scoring is normal in the area swept by the brake pads, but if heavy scoring or cracks are found, the disc must be renewed.

3 It is normal to find a lip of rust and brake dust around the disc's perimeter; this can be scraped off if required. If, however, a lip has formed due to excessive wear of the brake pad swept area, then the disc's thickness must be measured using a micrometer (see illustration). Take measurements at several places around the disc, at the inside and outside of the pad swept area; if the disc has worn at any point to the specified minimum thickness or less, the disc must be renewed.

4 If the disc is thought to be warped, it can be checked for run-out. Either use a dial gauge mounted on any convenient fixed point while the disc is slowly rotated, or use feeler blades to measure (at several points all around the disc) the clearance between the disc and a



6.3 Using a micrometer to measure disc thickness



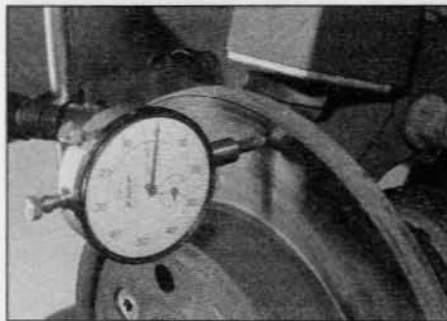

6.4 Checking disc run-out using a dial gauge

fixed point, such as the caliper mounting bracket (see illustration). If the measurements obtained are at the specified maximum or beyond, the disc is excessively warped, and must be renewed; however, it is worth checking first that the hub bearing is in good condition (Chapter 1A or 1B and/or 10). Also try the effect of removing the disc and turning it through 180° to reposition it on the hub; if the run-out is still excessive, the disc must be renewed.

5 Check the disc for cracks, especially around the wheel bolt holes, and any other wear or damage, and renew if necessary.

**Removal**

6 Remove the brake pads as described in Section 4.

7 Undo the two bolts securing the caliper mounting bracket to the swivel hub (see illustration). Withdraw the mounting bracket, complete with caliper, from the disc and swivel hub, and tie it to the front suspension coil spring, to avoid placing any strain on the fluid hose.

8 Use chalk or paint to mark the relationship of the disc to the hub, then remove the screws securing the brake disc to the hub, and remove the disc (see illustrations). If it is tight, lightly tap its rear face with a hide or plastic mallet.

**Refitting**

9 Refitting is the reverse of the removal procedure, noting the following points:

- a) Ensure that the mating surfaces of the disc and hub are clean and flat.

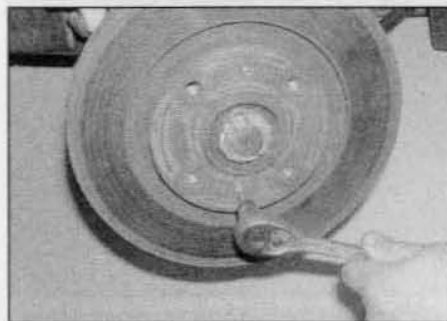

6.8a Undo the two retaining screws . . .

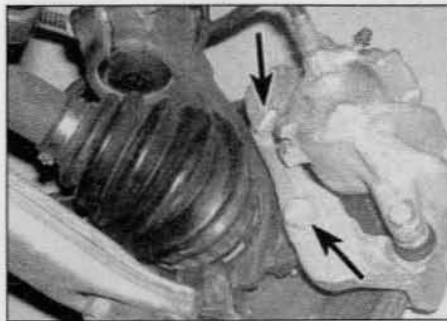

6.7 Front caliper mounting bracket retaining bolts (arrowed)

- b) Align (if applicable) the marks made on removal, and securely tighten the disc retaining screws.
- c) If a new disc has been fitted, use a suitable solvent to wipe any preservative coating from the disc before refitting the caliper.
- d) Apply suitable thread locking compound to the threads of the caliper mounting bracket retaining bolts and tighten the bolts to the specified torque.
- e) Refit the brake pads as described in Section 4.
- f) Refit the roadwheel, then lower the vehicle to the ground and tighten the roadwheel bolts to the specified torque. On completion, repeatedly depress the brake pedal until normal (non-assisted) pedal pressure returns.

**7 Rear brake drum - removal, inspection and refitting**

**Note:** Before starting work, refer to the note at the beginning of Section 5 concerning the dangers of asbestos dust.

**Removal**

- 1 Chock the front wheels, then jack up the rear of the vehicle and support it on axle stands (see *Jacking and vehicle support*). Remove the appropriate rear roadwheel and release the handbrake.
- 2 Remove the drum retaining screw(s).
- 3 It should now be possible to withdraw the

brake drum by hand. It may be difficult to remove the drum due to the brake shoes binding on the inner circumference of the drum. If the brake shoes are binding, first check that the handbrake is fully released, then proceed as follows.

4 Turn the drum until one of the wheel bolt holes is positioned over the handbrake operating lever on the trailing shoe. This will be at approximately the 5 o'clock position on the left-hand rear brake, and the 7 o'clock position on the right-hand rear brake. Insert a screwdriver through the wheel bolt hole and move the handbrake operating lever towards the rear of the vehicle allowing the brake shoes to retract fully. It will be necessary to lift the lever slightly with the screwdriver so that the lever stop-peg can pass over the brake shoe web. The brake drum can now be withdrawn.

**Inspection**

**Note:** If either drum requires renewal, BOTH should be renewed at the same time, to ensure even and consistent braking. New brake shoes should also be fitted.

5 Working carefully, remove all traces of brake dust from the drum, but avoid inhaling the dust, as it is injurious to health.

6 Clean the outside of the drum, and check it for obvious signs of wear or damage, such as cracks around the roadwheel bolt holes; renew the drum if necessary.

7 Examine carefully the inside of the drum. Light scoring of the friction surface is normal, but if heavy scoring is found, the drum must be renewed. It is usual to find a lip on the drum's inboard edge which consists of a mixture of rust and brake dust; this should be scraped away, to leave a smooth surface which can be polished with fine (120- to 150-grade) emery paper. If, however, the lip is due to the friction surface being recessed by excessive wear, then the drum must be renewed.

8 If the drum is thought to be excessively worn, or oval, its internal diameter must be measured at several points using an internal micrometer. Take measurements in pairs, the second at right-angles to the first, and compare the two, to check for signs of ovality. Provided that it does not enlarge the drum to beyond the specified maximum diameter, it may be possible to have the drum refinished by skimming or grinding; if this is not possible, the drums on both sides must be renewed. Note that if the drum is to be skimmed, BOTH drums must be refinished, to maintain a consistent internal diameter on both sides.

**Refitting**

9 If a new brake drum is to be installed, use a suitable solvent to remove any preservative coating that may have been applied to its interior. Note that it may also be necessary to shorten the adjuster strut length, by rotating the strut wheel, to allow the drum to pass over the brake shoes.



6.8b . . . and remove the front brake disc

10 Ensure that the handbrake lever stop-peg is correctly repositioned against the edge of the brake shoe web, then locate the brake drum on the stub axle.

11 Refit and tighten the drum retaining screw(s).

12 Depress the footbrake several times to operate the self-adjusting mechanism.

13 Repeat the above procedure on the remaining rear brake assembly (where necessary), then check and, if necessary, adjust the handbrake cable as described in Section 13.

14 On completion, refit the roadwheel(s), then lower the vehicle to the ground and tighten the wheel bolts to the specified torque.

## 8 Front brake caliper – removal, overhaul and refitting



**Note 1:** Before starting work, refer to the note at the beginning of Section 2 concerning the dangers of hydraulic fluid, and to the warning at the beginning of Section 4 concerning the dangers of asbestos dust.

**Note 2:** New guide pin bolts must be used on refitting.

### Removal

1 Apply the handbrake, then jack up the front of the vehicle and support it on axle stands (see *Jacking and vehicle support*). Remove the appropriate roadwheel.

2 Minimise fluid loss by first removing the master cylinder reservoir filler cap, and then tightening it down onto a piece of polythene, to obtain an airtight seal. Alternatively, use a brake hose clamp, a G-clamp or a similar tool to clamp the flexible hose.

3 Clean the area around the hydraulic fluid hose union on the caliper, then loosen the fluid hose union nut by half a turn.

4 With reference to Section 4, slacken and remove the upper and lower caliper guide pin bolts. If working on the Lucas caliper, use a slim open-ended spanner to prevent the guide pin itself from rotating. Discard the guide pin bolts – new bolts must be used on refitting. With the guide pin bolts removed, lift the caliper away from the brake disc, then unscrew the caliper from the end of the brake hose. Note that the brake pads need not be disturbed, and can be left in position in the caliper mounting bracket.

### Overhaul

5 The caliper can be overhauled after obtaining the relevant repair kit from a Peugeot/Citroën dealer. Ensure that the correct repair kit is obtained for the caliper being worked on. Note the locations of all components to ensure correct refitting, and lubricate the new seals using clean brake fluid. Follow the assembly instructions supplied with the repair kit.

### Refitting

6 Screw the caliper body fully onto the flexible hydraulic fluid hose union, then check that the brake pads are still correctly fitted in the caliper mounting bracket.

7 Position the caliper over the brake pads. If the threads of the new guide pin bolts are not pre-coated with locking compound, apply a suitable locking compound to them. Fit the new lower guide pin bolt, then press the caliper into position and fit the new upper guide pin bolt. If working on the Bosch caliper, position the flat on the guide pins horizontally to allow the machined face on the caliper mounting lugs to correctly engage. Tighten both the guide pin bolts to the specified torque, while retaining the guide pin with an open-ended spanner (where necessary).

8 Tighten the hydraulic fluid hose union securely, then remove the brake hose clamp or polythene, where fitted, and bleed the hydraulic system as described in Section 2. Providing the precautions described were taken to minimise brake fluid loss, it should only be necessary to bleed the relevant front brake.

9 Depress the brake pedal repeatedly, until the pads are pressed into firm contact with the brake disc, and normal (non-assisted) pedal pressure is restored.

10 Refit the roadwheel, then lower the vehicle to the ground and tighten the roadwheel bolts to the specified torque.

## 9 Rear wheel cylinder – removal and refitting



**Note:** Before starting work, refer to the note at the beginning of Section 2 concerning the dangers of hydraulic fluid, and to the warning at the beginning of Section 5 concerning the dangers of asbestos dust.

### Removal

1 Remove the rear brake shoes as described in Section 5.

2 Minimise fluid loss by first removing the master cylinder reservoir filler cap, and then tightening it down onto a piece of polythene, to obtain an airtight seal. Alternatively, use a brake hose clamp, a G-clamp or a similar tool

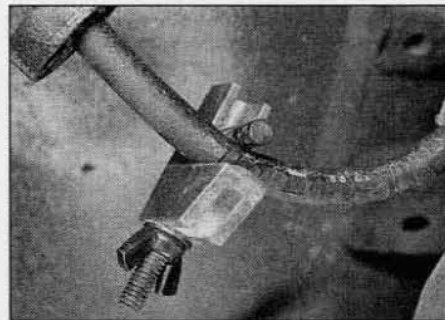

9.2 To minimise fluid loss, fit a brake hose clamp to the flexible hose

to clamp the flexible hose at the nearest convenient point to the wheel cylinder (see *illustration*).

3 Wipe away all traces of dirt around the brake pipe union at the rear of the wheel cylinder, and unscrew the union nut (see *illustration*). Carefully ease the pipe out of the wheel cylinder, and plug or tape over its end to prevent dirt entry. Wipe off any spilt fluid immediately.

4 Unscrew the two wheel cylinder retaining bolts from the rear of the backplate, and remove the cylinder, taking great care not to allow surplus hydraulic fluid to contaminate the brake shoe linings.

5 Note that it is not possible to overhaul the cylinder, since no components are available separately. If faulty, the complete wheel cylinder assembly must be renewed.

### Refitting

6 The arrangement of the brake shoe components is such that the wheel cylinder must be released from the backplate to allow the shoes to be refitted. Follow the brake shoe refitting procedures contained in Section 5 then, with the wheel cylinder in position, proceed as follows.

7 Engage the brake pipe, and screw in the union nut two or three turns to ensure that the thread has started.

8 Insert the two wheel cylinder retaining bolts, and tighten them securely. Now fully tighten the brake pipe union nut.

9 Remove the clamp from the flexible brake hose, or the polythene from the master cylinder reservoir (as applicable).

10 Bleed the brake hydraulic system as described in Section 2. Providing suitable precautions were taken to minimise loss of fluid, it should only be necessary to bleed the relevant rear brake.

## 10 Master cylinder – removal, overhaul and refitting



**Note:** Before starting, refer to the warning in Section 2 on the dangers of hydraulic fluid.

### Removal

1 On left-hand drive models, remove the battery and battery tray as described in

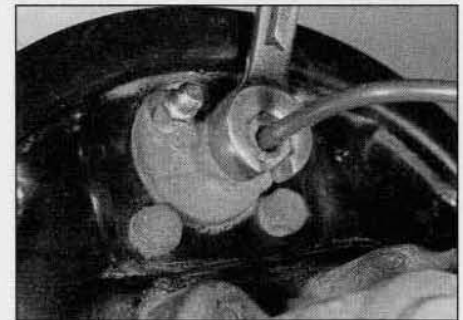

9.3 Using a brake pipe spanner to unscrew the wheel cylinder union nut



Chapter 5A. Depending on model and clearance available, remove any remaining air cleaner and air intake duct components as described in the relevant Part of Chapter 4, to gain access to the master cylinder.

2 Unscrew the master cylinder fluid reservoir filler cap and empty the brake fluid from the reservoir by syphoning it out using a syringe or pipette. **Note:** Do not syphon the fluid by mouth, as it is poisonous.

3 Disconnect the wiring connector at the fluid level sensor on the side of the reservoir, and release the wiring from its cable clip.

4 Suitably cover the area below the master cylinder with absorbent rags and be prepared for escaping hydraulic fluid.

5 Wipe clean the area around the brake hydraulic pipe unions on the side of the master cylinder. Make a note of the correct fitted positions of the unions, then unscrew the union nuts/bolts and carefully withdraw the pipes. Where banjo unions are fitted, recover the copper washers located on each side of the union and obtain new washers for refitting. Plug or tape over the pipe ends and master cylinder orifices, to minimise fluid loss, and to prevent the entry of dirt into the system.

6 Slacken and remove the two nuts securing the master cylinder to the vacuum servo unit, then withdraw the unit from the servo. If the sealing ring fitted to the rear of the master cylinder shows signs of damage or deterioration, it must be renewed.

7 If required, the fluid reservoir can be removed from the master cylinder. Various methods are used to secure the reservoir in position, depending on master cylinder type. These will be either a nut, bolt and retaining clamp located under the master cylinder, a roll-pin, or a retaining pin and clip. Remove the relevant attachment, then pull the reservoir upwards and off its two seals in the master cylinder.

### Overhaul

8 Check that spare parts are available before deciding to overhaul the master cylinder. Although Peugeot/Citroën dealers supply internal parts for some (but not all) of the master cylinders fitted, it may be possible to obtain a repair kit from specialist motor factors. Ensure that the correct repair kit is obtained for the master cylinder being worked on. Note the locations of all components to ensure correct refitting, and lubricate the new seals using clean brake fluid. Follow the assembly instructions supplied with the repair kit.

### Refitting

9 If removed, carefully ease the fluid reservoir back into position, ensuring that it is fully seated on the rubber seals. Refit the relevant retaining components to secure the reservoir to the master cylinder.

10 Fit the master cylinder to the servo unit, ensuring that the servo unit pushrod enters the master cylinder bore centrally. Refit the

master cylinder mounting nuts, and tighten them to the specified torque.

11 Wipe clean the brake pipe unions, refit them to the master cylinder ports and tighten them securely. Where banjo unions are used, ensure that a new copper washer is fitted on each side of the union.

12 Reconnect the fluid level sensor wiring connector and retain the wiring with the cable clip.

13 On left-hand drive models, refit the battery tray and battery, referring to Chapter 5A if necessary. Refit the air cleaner and air intake duct components removed for access, as described in the relevant Part of Chapter 4.

14 Refill the master cylinder reservoir with new fluid, and bleed the complete hydraulic system as described in Section 2.

## 11 Vacuum servo unit – testing, removal and refitting

### Testing

1 To test the operation of the servo unit, depress the footbrake several times to exhaust the vacuum, then start the engine whilst keeping the pedal firmly depressed. As the engine starts, there should be a noticeable 'give' in the brake pedal as the vacuum builds-up. Allow the engine to run for at least two minutes, then switch it off. If the brake pedal is now depressed it should feel normal, but further applications should result in the pedal feeling firmer, with the pedal stroke decreasing with each application.

2 If the servo does not operate as described, first inspect the servo unit check valve as described in Section 12. On diesel engine models, also check the operation of the vacuum pump as described in Section 22.

3 If the servo unit still fails to operate satisfactorily, the fault lies within the unit itself. Repairs to the unit are not possible – if faulty, the servo unit must be renewed.

### Removal

4 Disconnect the battery negative terminal (refer to *Disconnecting the battery* in the Reference Chapter).

5 On left-hand drive models, remove the battery and battery tray as described in Chapter 5A. Depending on model and clearance available, remove any remaining air cleaner and air intake duct components as described in the relevant Part of Chapter 4, to gain access to the servo unit.

6 Remove the master cylinder as described in Section 10.

7 Slacken the retaining clip, or depress the tabs on the side of the quick-release fitting, and disconnect the vacuum pipe from the servo unit check valve.

8 Working inside the car, remove the fusebox cover and the undercover from beneath the fascia on the driver's side.

9 Prise off the spring clip, then withdraw the clevis pin securing the servo unit pushrod to the brake pedal. Note that a new spring clip will be required for refitting.

10 Slacken and remove the four nuts securing the servo unit to the bulkhead.

11 Manoeuvre the servo unit out of position, along with its gasket which is fitted between the servo and housing. Renew the gasket if it shows signs of damage.

### Refitting

12 Locate the servo unit in position from within the engine compartment.

13 From inside the car, refit the servo retaining nuts and tighten them to the specified torque.

14 Refit the servo unit pushrod-to-brake pedal clevis pin, and secure it in position with a new spring clip.

15 Refit the fusebox cover and the undercover from beneath the fascia.

16 Reconnect the vacuum pipe to the servo unit check valve.

17 Refit the master cylinder as described in Section 10, then bleed the complete hydraulic system as described in Section 2.

18 On left-hand drive models, refit the battery tray and battery, referring to Chapter 5A if necessary. Refit the air cleaner and air intake duct components removed for access, as described in the relevant Part of Chapter 4.

19 On completion, reconnect the battery, start the engine, and check for air leaks at the servo unit check valve.

## 12 Vacuum servo unit check valve – removal, testing and refitting

### Removal

1 On left-hand drive models, remove the battery and battery tray as described in Chapter 5A. Depending on model and clearance available, remove any remaining air cleaner and air intake duct components as described in the relevant Part of Chapter 4, to gain access to the servo unit.

2 Slacken the retaining clip, or depress the tabs on the side of the quick-release fitting, and disconnect the vacuum pipe from the check valve.

3 Withdraw the valve from its rubber sealing grommet in the servo unit, using a pulling and twisting motion. Remove the grommet from the servo.

### Testing

4 Examine the check valve for signs of damage, and renew if necessary. The valve may be tested by blowing through it in both directions. Air should flow through the valve in one direction only – when blown through from the servo unit end of the valve. Renew the valve if this is not the case.



5 Examine the rubber sealing grommet and flexible vacuum hose for signs of damage or deterioration, and renew as necessary.

### Refitting

- 6 Fit the sealing grommet into the servo unit.
- 7 Ease the check valve into position, taking care not to displace or damage the grommet.
- 8 Reconnect the vacuum pipe to the check valve.
- 9 On left-hand drive models, refit the battery tray and battery, referring to Chapter 5A if necessary. Refit the air cleaner and air intake duct components removed for access, as described in the relevant Part of Chapter 4.
- 10 On completion, reconnect the battery, start the engine and check for air leaks at the check valve.

### 13 Handbrake – adjustment

1 To check the handbrake adjustment, first apply the footbrake firmly several times to establish correct shoe-to-drum clearance, then apply and release the handbrake several times to ensure that the self-adjust mechanism is fully adjusted. Applying normal moderate pressure, pull the handbrake lever to the fully-applied position, counting the number of clicks emitted from the handbrake ratchet mechanism. If adjustment is correct, there should be 5 clicks before the handbrake is fully applied. If this is not the case, adjust as follows.

2 Remove the rear section of the centre console as described in Chapter 11 for access to the handbrake adjuster nut.

3 Chock the front wheels then jack up the rear of the vehicle and support it securely on axle stands (see *Jacking and vehicle support*).

4 Apply and release the handbrake four times.

5 With the handbrake set on the fifth notch of the ratchet mechanism, check that both rear wheels are locked. If not, tighten the handbrake adjusting nut until both rear wheels are locked (see *illustration*). Once this is so, fully release the handbrake lever, and check that the rear wheels rotate freely. Check the adjustment by applying the handbrake fully,

counting the clicks from the handbrake ratchet and, if necessary, re-adjust.

6 When the adjustment is correct, refit the centre console, then lower the vehicle to the ground.

### 14 Handbrake lever – removal and refitting

#### Removal

1 Remove the rear section of the centre console as described in Chapter 11 for access to the handbrake adjuster nut.

2 Chock the front wheels then jack up the rear of the vehicle and support it securely on axle stands (see *Jacking and vehicle support*).

3 Ensure that the handbrake is released, then unscrew the handbrake adjuster nut to allow the adjuster rod to be withdrawn from the equaliser plate (see *illustration 13.5*).

4 Disconnect the wiring connector from the handbrake warning light switch, and release the cable from its retaining clip.

5 Undo and remove the three retaining nuts and lift the lever from its mounting studs (see *illustration*). Withdraw the adjuster rod from the equaliser plate and remove the lever assembly from the car.

#### Refitting

6 Refitting is a reversal of removal. Prior to refitting the centre console, adjust the handbrake as described in Section 13.

### 15 Handbrake cables – removal and refitting

#### Removal

1 The handbrake cable consists of two sections, a right- and a left-hand section, which are linked to the lever by an equaliser plate. Each section can be removed individually.

2 Remove the rear section of the centre console as described in Chapter 11 for access to the handbrake adjuster nut.

3 Chock the front wheels then jack up the rear of the vehicle and support it securely on axle stands (see *Jacking and vehicle support*).

4 Ensure that the handbrake is released, then unscrew the handbrake adjuster nut (see *illustration 13.5*). Slide the equaliser plate off the adjuster rod and slip the relevant handbrake inner cable end out of the equaliser plate.

5 Where necessary, slacken and remove the retaining nuts, then release the exhaust system heat shield(s) from the vehicle underbody, to gain access to the front of the relevant handbrake cable. Free the front end of the outer cable from the body, and withdraw the cable from its support guide.

6 Working back along the length of the cable, free it from the fuel tank plastic clip and the wire support hooks on the underbody and trailing arm.

7 Remove the rear brake shoes from the relevant side as described in Section 5. Using pliers, carefully release the outer cable from the brake backplate, and remove it from underneath the vehicle (see *illustration*).

#### Refitting

8 Refitting is a reversal of removal. Prior to refitting the centre console, adjust the handbrake as described in Section 13.

### 16 Rear brake pressure-regulating valve – removal and refitting

**Note 1:** Before starting work, refer to the warning at the beginning of Section 2 concerning the dangers of hydraulic fluid.

**Note 2:** The rear brake pressure-regulating valve is not fitted to later models with ABS.

#### Removal

1 Firmly chock the front wheels, then jack up the rear of the vehicle and support it on axle stands (see *Jacking and vehicle support*). Remove the right-hand rear roadwheel.

2 Minimise fluid loss by first removing the master cylinder reservoir filler cap, and tightening it down onto a piece of polythene, to obtain an airtight seal.

3 Disconnect the regulating valve operating spring from the bracket on the rear suspension.

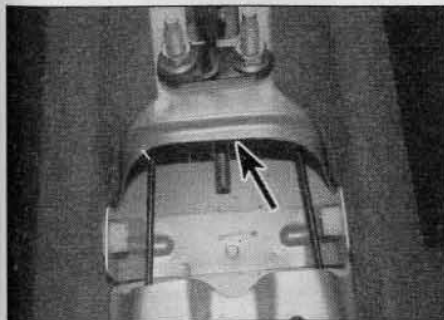

13.5 Handbrake adjusting nut location (arrowed)

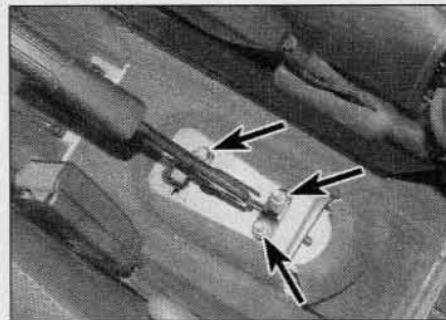

14.5 Handbrake lever retaining nuts (arrowed)

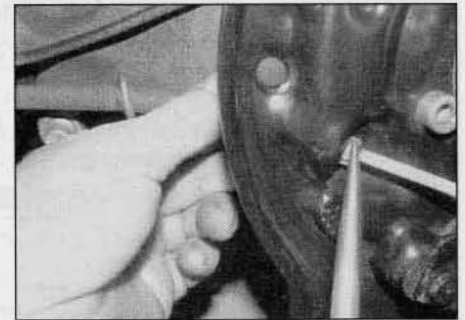

15.7 Release the handbrake outer cable from the brake backplate

4 Wipe clean the area around the brake pipe unions on the valve, and place absorbent rags beneath the pipe unions to catch any surplus fluid.

5 Unscrew the union nuts and carefully withdraw the brake pipes from the pressure-regulating valve. Plug or tape over the pipe ends and valve orifices, to minimise the loss of brake fluid, and to prevent the entry of dirt into the system.

6 Undo the bolt securing the valve to the mounting bracket and remove the assembly from under the car.

### Refitting

7 Refitting is a reverse of the removal procedure, ensuring that the brake pipe union nuts are securely tightened. On completion, bleed the complete braking system as described in Section 2. If a new valve has been fitted, or if the adjusting nuts on the operating rod have been disturbed, the vehicle should be taken to a Peugeot/Citroën dealer for adjustment of the valve pressure settings.

### 17 Stop-light switch – removal, refitting and adjustment



### Removal

1 The stop-light switch is located on the brake pedal bracket under the fascia.

2 Remove the fusebox cover and the undercover from beneath the fascia on the driver's side.

3 Disconnect the wiring connector, then loosen the locking ring and unscrew the switch from the pedal bracket.

### Refitting and adjustment

4 Screw the switch back into position in the mounting bracket, until the gap between the end of the main body of the switch and the lug on the brake pedal is 2.0 to 3.0 mm.

5 Once the stop-light switch is correctly positioned, reconnect the wiring connector, and check the operation of the stop-lights. The stop-lights should illuminate after the brake pedal has travelled approximately 5.0 mm.

6 When the adjustment is correct, secure the switch with the locking ring and refit the fusebox cover and the undercover from beneath the fascia.

### 18 Handbrake 'on' warning light switch – removal and refitting



### Removal

1 Remove the rear section of the centre console as described in Chapter 11 for access to the handbrake lever assembly.

2 Disconnect the wiring connector and

remove the switch from the frame of the handbrake lever.

### Refitting

3 Refitting is a reverse of the removal procedure.

## 19 Anti-lock braking system (ABS) – general information

ABS is fitted as standard or optional equipment, according to model and year of manufacture. The system comprises a hydraulic modulator unit and the four wheel speed sensors. The modulator unit contains the electronic control unit (ECU), the hydraulic solenoid valves and the electrically-driven return pump. The purpose of the system is to prevent the wheel(s) locking during heavy braking. This is achieved by automatic release of the brake on the relevant wheel, followed by re-application of the brake.

The solenoid valves are controlled by the ECU, which itself receives signals from the four wheel speed sensors which monitor the speed of rotation of each wheel. By comparing these signals, the ECU can determine the speed at which the vehicle is travelling. It can then use this speed to determine when a wheel is decelerating at an abnormal rate, compared to the speed of the vehicle, and therefore predicts when a wheel is about to lock. During normal operation, the system functions in the same way as a non-ABS braking system.

If the ECU senses that a wheel is about to lock, it closes the relevant outlet solenoid valves in the hydraulic unit, which then isolates the relevant brake(s) on the wheel(s) which is/are about to lock from the master cylinder, effectively sealing-in the hydraulic pressure.

If the speed of rotation of the wheel continues to decrease at an abnormal rate, the ECU opens the inlet solenoid valves on the relevant brake(s), and operates the electrically-driven return pump which pumps the hydraulic fluid back into the master cylinder, releasing the brake. Once the speed of rotation of the wheel returns to an acceptable rate, the pump stops; the solenoid valves switch again, allowing the hydraulic master cylinder pressure to return to the caliper or wheel cylinder, which then re-applies the brake. This cycle can be carried out many times a second.

The action of the solenoid valves and return pump creates pulses in the hydraulic circuit. When the ABS system is functioning, these pulses can be felt through the brake pedal.

The operation of the ABS system is entirely dependent on electrical signals. To prevent the system responding to any inaccurate signals, a built-in safety circuit monitors all signals received by the ECU. If an inaccurate signal or low battery voltage is detected, the

ABS system is automatically shut-down, and the warning light on the instrument panel is illuminated, to inform the driver that the ABS system is not operational. Normal braking should still be available, however.

Later models, from approximately 2001 onward are also equipped with additional safety features built around the ABS system. These systems are EBFD (Electronic Brake Force Distribution), which automatically apportions braking effort between the front and rear wheels, and (on some models) ESP (Electronic Stability Program) which monitors the vehicles cornering forces and steering wheel angle, then applies the braking force to the appropriate roadwheel to enhance the stability of the vehicle.

If a fault does develop in any of these systems, the vehicle must be taken to a Peugeot/Citroën dealer or suitably-equipped specialist for fault diagnosis and repair.

## 20 Anti-lock braking system (ABS) components – removal and refitting



### Modulator assembly

**Note:** Before starting, refer to the note in Section 2 on the dangers of hydraulic fluid.

### Removal

1 Remove the battery and battery tray as described in Chapter 5A. Depending on model and clearance available, remove any remaining air cleaner and air intake duct components as described in the relevant Part of Chapter 4, to gain access to the modulator assembly.

2 Release the locking clip and disconnect the ECU wiring harness connector.

3 Minimise hydraulic fluid loss by first removing the master cylinder reservoir filler cap, then tightening it down onto a piece of polythene, to obtain an airtight seal.

4 Wipe clean the area around the brake pipe unions on the side of the modulator, and place absorbent rags beneath the pipe unions to catch any surplus fluid. Make a note of the correct fitted positions of the unions, then unscrew the union nuts and carefully withdraw the pipes. Plug or tape over the pipe ends and modulator orifices to minimise the loss of fluid, and to prevent the entry of dirt into the system.

5 Undo the retaining nuts, and lift the modulator from its location. When sufficient clearance exists, undo the nut and disconnect the earth lead (where fitted) from the end of the modulator return pump casing.

### Refitting

6 If a new modulator assembly is being fitted, it will be supplied pre-filled with hydraulic fluid, and sealed with blanking plugs. Leave the plugs in position until just before connecting the brake pipes.



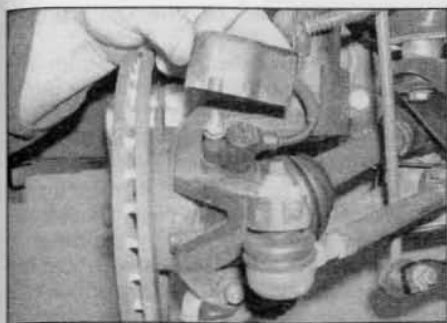

20.17 Unscrew the nut and lift off the wheel sensor protective cover

7 Locate the modulator in position and refit the earth lead and its retaining nut. Engage the unit over the mounting studs and secure with the retaining nuts, tightened to the specified torque.

8 Reconnect the brake pipes to their correct locations as noted during removal and tighten the union nuts securely.

9 Reconnect the ECU wiring connector.

10 Refit the battery tray and battery, referring to Chapter 5A if necessary. Refit the air cleaner and air intake duct components removed for access, as described in the relevant Part of Chapter 4.

11 Remove the polythene from the master cylinder reservoir and bleed the complete hydraulic system as described in Section 2.

### Electronic control unit

12 The electronic control unit is removed with the modulator assembly as described previously. The ECU is an integral part of the modulator and the two components cannot be separated.

### Front wheel speed sensor

**Note:** Thread locking compound must be applied to the sensor securing stud on refitting.



20.18a Unscrew the securing stud . . .

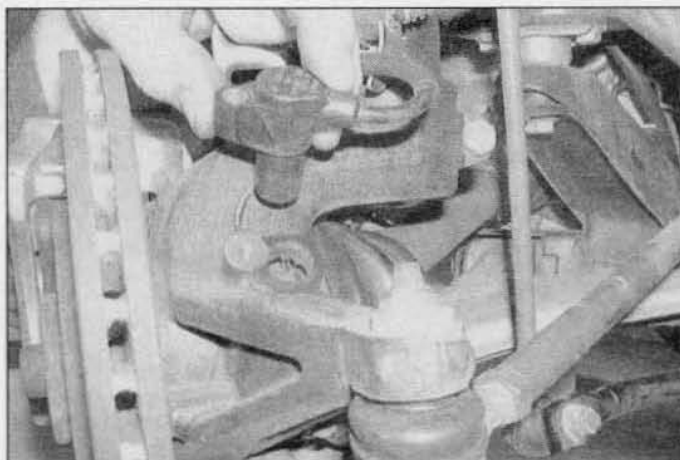

20.18b . . . and withdraw the front wheel sensor from the swivel hub

### Removal

13 Disconnect the battery negative terminal (refer to *Disconnecting the battery* in the Reference Chapter).

14 Firmly apply the handbrake, then jack up the front of the car and support it securely on axle stands (see *Jacking and vehicle support*). Remove the relevant front roadwheel.

15 Unclip the wheel speed sensor wiring from the brackets on the suspension strut and inner wheelarch.

16 Trace the wiring back from the sensor, and separate the two halves of the wiring connector. Note the routing of the wiring to aid correct refitting.

17 Unscrew the retaining nut and lift off the wheel speed sensor protective cover (see illustration).

18 Unscrew the securing stud, and withdraw the sensor from the swivel hub (see illustrations).

### Refitting

19 Refitting is a reversal of removal, noting the following points:

- Ensure that the mating faces of the sensor and the swivel hub are clean, and apply a smear of high melting-point brake grease to the sensor location in the swivel hub before refitting.
- Ensure that the end face of the sensor is clean.
- Coat the threads of the sensor securing stud with thread-locking compound and tighten the stud to the specified torque.
- Route the wiring as noted before removal.

### Rear wheel speed sensor

**Note:** Thread-locking compound must be applied to the sensor securing stud on refitting.

### Removal

20 Chock the front wheels, then jack up the rear of the vehicle and support it on axle stands (see *Jacking and vehicle support*). Remove the appropriate roadwheel.

21 Trace the wiring back from the sensor to its wiring connector, then free the connector from its retaining clip, and disconnect the wiring from the main wiring loom.

22 Work back along the sensor wiring, and free it from the retaining clips. Note the routing of the wiring to aid correct refitting.

23 Slacken and remove the bolt securing the sensor unit to the trailing arm, and remove the sensor and lead assembly.

### Refitting

24 Refitting is a reversal of removal, bearing in mind the following points:

- Ensure that the mating faces of the sensor and the trailing arm are clean, and apply a smear of high melting-point brake grease to the sensor location in the trailing arm before refitting.
- Ensure that the end face of the sensor is clean.
- Coat the threads of the sensor securing bolt with thread-locking compound and tighten the stud to the specified torque.
- Route the wiring as noted before removal.

### 21 Vacuum pump (diesel engine models) – removal and refitting

**Note:** New O-rings must be used on refitting.

### Removal

1 Disconnect the battery negative terminal (refer to *Disconnecting the battery* in the Reference Chapter).

2 Remove the air cleaner assembly and air intake ducts as described in Chapter 4B or 4C.

3 Release the retaining clip and disconnect the vacuum hose from the pump.

4 Slacken and remove the three bolts/nuts and washers securing the pump to the left-hand end of the cylinder head, then remove the pump, along with its two O-rings. Discard the O-rings – new ones must be used on refitting. On 2.0 litre models, check the



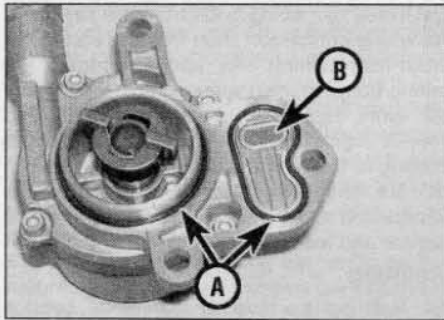

21.5 Vacuum pump O-ring locations (A) and gauze filter (B)

condition of the gauze filter at the rear of the pump and renew if necessary.

**Refitting**

5 Fit new O-rings to the pump recesses, then

align the drive dog with the slot in the end of the camshaft, and refit the pump to the cylinder head, ensuring that the O-rings remain correctly seated (see illustration).

6 Refit the pump mounting bolts/nuts and washers, and tighten them to the specified torque.

7 Reconnect the vacuum hose to the pump, and tighten its securing clip.

8 Refit the air cleaner assembly and air intake ducts as described in Chapter 4B or 4C, then reconnect the battery

**22 Vacuum pump (diesel engine models) – testing and overhaul**



**Testing**

1 The operation of the braking system

vacuum pump can be checked using a vacuum gauge.

2 Disconnect the vacuum pipe from the pump, and connect the gauge to the pump union using a suitable length of hose.

3 Start the engine and allow it to idle, then measure the vacuum created by the pump. As a guide, after one minute, a minimum of approximately 500 mm Hg should be recorded. If the vacuum registered is significantly less than this, it is likely that the pump is faulty. However, seek the advice of a Peugeot/Citroën dealer before condemning the pump.

**Overhaul**

4 Overhaul of the vacuum pump is not possible, since no components are available separately for it. If faulty, the complete pump assembly must be renewed.

# Chapter 10

## Suspension and steering

### Contents

Section number	Section number
Front hub bearings – renewal . . . . .	3
Front suspension and steering check . . . . .	See Chapter 1A or 1B
Front suspension anti-roll bar – removal and refitting . . . . .	8
Front suspension anti-roll bar connecting link – removal and refitting . . . . .	9
Front suspension lower arm – removal, overhaul and refitting . . . . .	6
Front suspension lower arm balljoint – removal and refitting . . . . .	7
Front suspension strut – overhaul . . . . .	5
Front suspension strut – removal and refitting . . . . .	4
Front suspension subframe – removal and refitting . . . . .	10
Front swivel hub assembly – removal and refitting . . . . .	2
General information . . . . .	1
Ignition switch/steering column lock – removal and refitting . . . . .	19
Power steering fluid level check . . . . .	See <i>Weekly checks</i>
Power steering pump – removal and refitting . . . . .	22
Power steering system – bleeding . . . . .	21
Rear axle assembly – removal and refitting . . . . .	15
Rear hub assembly – removal and refitting . . . . .	11
Rear hub bearings – renewal . . . . .	12
Rear shock absorber – removal, testing and refitting . . . . .	14
Rear suspension components – general . . . . .	13
Steering column – removal, inspection and refitting . . . . .	18
Steering gear assembly – removal, overhaul and refitting . . . . .	20
Steering wheel – removal and refitting . . . . .	17
Track rod balljoint – removal and refitting . . . . .	23
Vehicle ride height – checking . . . . .	16
Wheel alignment and steering angles – general information, checking and adjustment . . . . .	24
Wheel and tyre maintenance and tyre pressure checks . . . . .	See <i>Weekly checks</i>

### Degrees of difficulty

**Easy**, suitable for novice with little experience



**Fairly easy**, suitable for beginner with some experience



**Fairly difficult**, suitable for competent DIY mechanic



**Difficult**, suitable for experienced DIY mechanic



**Very difficult**, suitable for expert DIY or professional



### Specifications

#### Front wheel alignment

Front wheel toe setting:

Up to September 2002:

With manual steering . . . . . 1.0 to 3.0 mm toe-out

With power-assisted steering . . . . . 1.0 to 3.0 mm toe-in

September 2002 onward . . . . . 1.0 ± 1.0 mm toe-in

#### Roadwheels

Type . . . . . Pressed-steel or aluminium alloy (depending on model)

Torque wrench settings	Nm	lbf ft
<b>Front suspension</b>		
Anti-roll bar:		
Mounting clamp bolts	65	48
Connecting link securing nuts	40	30
Lower arm balljoint clamp bolt nut	40	30
Lower arm balljoint retaining nuts	50	37
Lower arm front pivot bolt	80	59
Lower arm rear pivot bush mounting bolts:		
8 mm bolt	35	26
10 mm bolt	65	48
Strut upper mounting bolts	25	18
Strut piston rod retaining nut	45	33
Subframe mounting bolts	85	63
Swivel hub-to-strut bolt	45	33
<b>Rear suspension</b>		
Rear axle mountings:		
Front mounting-to-body bolts	40	30
Rear mounting nuts	55	41
Rear hub nut:		
Nut with separate thrustwasher	275	203
Nut with integral thrustwasher	250	185
Shock absorber mounting nuts	110	81
<b>Steering</b>		
Power steering pump mounting bolts	22	16
Steering column mounting bolts	23	17
Steering column shaft-to-intermediate shaft universal joint pinch-bolt	23	17
Steering gear mounting bolts	70	52
Steering intermediate shaft-to-steering gear pinion universal joint		
pinch-bolt nut	23	17
Steering wheel bolt:		
Up to September 2002	33	24
September 2002 onward	20	15
Track rod balljoint-to-swivel hub nut	35	26
<b>Roadwheels</b>		
Wheel bolts	90	66

## 1 General information

The independent front suspension is of the MacPherson strut type, incorporating coil springs and integral telescopic shock absorbers. The MacPherson struts are located by transverse lower suspension arms, which utilise rubber inner mounting bushes, and incorporate a balljoint at the outer ends. The front swivel hubs, which carry the wheel bearings, brake calipers and the hub/disc assemblies, are clamped to the MacPherson struts, and connected to the lower arms via the balljoints. A front anti-roll bar is fitted to all models. The anti-roll bar is rubber-mounted onto the subframe, and is attached to the front suspension struts by a connecting link on each side.

The rear suspension is of the semi-independent trailing arm type, which consists of two trailing arms, linked by a tubular crossmember. A torsion bar is fitted

transversely between each trailing arm and the opposite suspension side member. An anti-roll bar is fitted between the trailing arms. The complete rear axle assembly is mounted onto the vehicle underbody by four rubber mountings.

The steering column has a universal joint fitted in the centre of its length, which is connected to an intermediate shaft having a second universal joint at its lower end. The lower universal joint is clamped to the steering gear pinion by means of a pinch-bolt.

The steering gear is mounted onto the front subframe, and is connected by two track rods, with balljoints at their outer ends, to the steering arms projecting rearwards from the swivel hubs. The track rods and balljoints are threaded, to facilitate toe setting adjustment.

Power-assisted steering was optionally available on early models and is fitted as standard on all models from September 2002 onwards. Hydraulic power for the steering system is provided by a pump, which is driven off the crankshaft pulley by the auxiliary drivebelt.

## 2 Front swivel hub assembly – removal and refitting

**Note:** All nuts disturbed on removal must be renewed as a matter of course. These nuts have threads which are pre-coated with locking compound (this is only effective once), and include the track rod balljoint nut, lower suspension arm balljoint clamp bolt nut, and the swivel hub clamp bolt nut. The driveshaft retaining nut must also be renewed, and suitable thread-locking compound will also be required for the brake caliper mounting bracket bolts.

### Removal

**Caution:** Do not allow the vehicle to rest on its wheels with one or both driveshafts disconnected from the swivel hubs, as damage to the wheel bearing(s) may result. If moving the vehicle is unavoidable, temporarily insert the outer end of the driveshaft(s) in the hub(s) and tighten the hub nut(s).



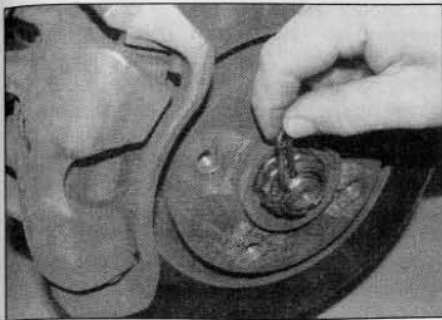

2.2a Withdraw the R-clip . . .

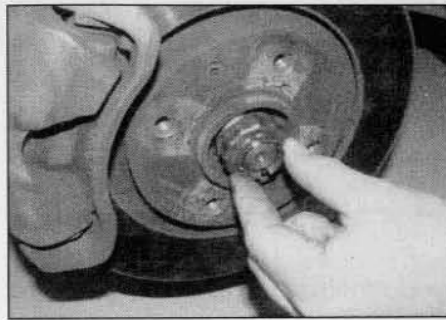

2.2b . . . and remove the locking cap from the driveshaft retaining nut

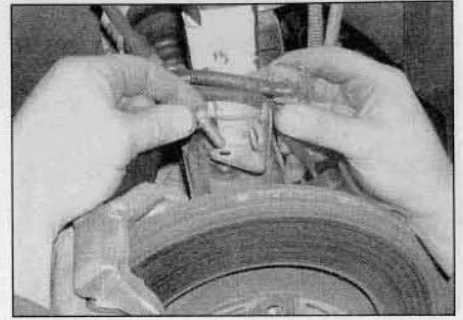

2.5 Remove the bolt securing the wiring retaining bracket to the swivel hub

1 Chock the rear wheels, then firmly apply the handbrake. Jack up the front of the vehicle, and support it on axle stands (see *Jacking and vehicle support*). Remove the appropriate front roadwheel.

2 Withdraw the R-clip, and remove the locking cap from the driveshaft retaining nut (see illustrations).

3 To prevent rotation of the wheel hub as the driveshaft retaining nut is slackened, make up a holding tool and bolt the tool to the wheel hub using two wheel bolts as described in Chapter 8, Section 2.

4 With the holding tool in place, slacken and remove the driveshaft retaining nut using a socket and long bar. Where necessary, support the socket on an axle stand to prevent it slipping off the nut. This nut is very tight; make sure that there is no risk of pulling the car off the axle stands as the nut is slackened.

5 Where applicable, disconnect the brake pad wear sensor wiring at the connector on the swivel hub. Slacken and remove the bolt securing the wiring retaining bracket to the top of the swivel hub (see illustration).

6 On models with ABS, remove the wheel speed sensor from the swivel hub as described in Chapter 9.

7 If the hub bearings are to be disturbed, remove the brake disc as described in Chapter 9. If not, unscrew the two bolts securing the brake caliper mounting bracket assembly to the swivel hub, and slide the caliper assembly off the disc. Using a piece of wire or string, tie the caliper to the front suspension coil spring, to avoid placing any strain on the hydraulic brake hose.

8 On all models, slacken and remove the nut securing the steering gear track rod balljoint to the swivel hub, and release the balljoint tapered shank using a balljoint separator.

9 Slacken and remove the nut, then withdraw the lower suspension arm balljoint clamp bolt from the swivel hub (see illustration). Discard the nut – a new one must be used on refitting.

10 Tap a small chisel into the split on the swivel hub to spread the hub slightly, and allow the balljoint shank to be withdrawn (see illustration). Pull the lower suspension arm downwards to release the balljoint shank from

the swivel hub. To do this it will be necessary to use a long bar and block of wood which will engage under the front subframe. Attach the bar to the suspension arm, preferably with a chain, or alternatively with a stout strap or rope. Lever down on the bar to release the balljoint from the swivel hub (see illustration).

11 Once the balljoint is free, remove the protector plate which is fitted to the balljoint shank (see illustration).

12 Undo the nut and withdraw the swivel hub-to-suspension strut clamp bolt.

13 Tap a small chisel into the split on the swivel hub to spread the hub slightly. Free the swivel hub assembly from the end of the strut, then release it from the outer constant velocity joint splines, and remove it from the vehicle.

### Refitting

14 Note that all nuts disturbed on removal must be renewed as a matter of course. These nuts have threads which are pre-coated with locking compound (this is only effective once), and include the track rod balljoint nut, lower suspension arm balljoint clamp bolt nut, and the swivel hub clamp bolt nut.

15 Ensure that the driveshaft outer constant velocity joint and hub splines are clean, then slide the hub fully onto the driveshaft splines.

16 Slide the hub assembly fully onto the suspension strut, aligning the split in the hub clamp with the lug on the base of the strut. Also ensure that the stop bosses on the strut are in contact with the top surface of the

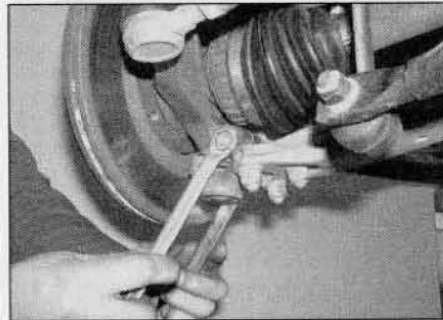

2.9 Undo the nut and withdraw the lower suspension arm balljoint clamp bolt from the swivel hub

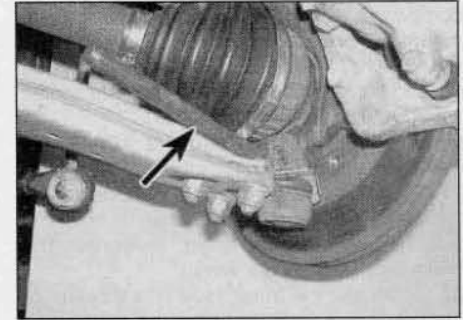

2.10a Spread the swivel hub by tapping a small chisel (arrowed) into the split . . .

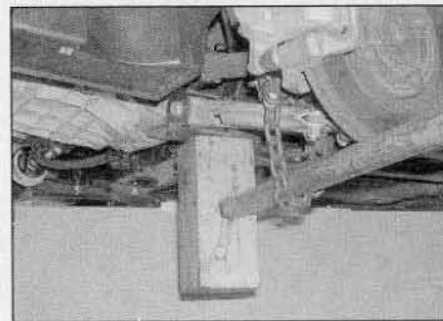

2.10b . . . then pull the lower suspension arm downwards using a bar and chain or similar arrangement, pivoting on the subframe

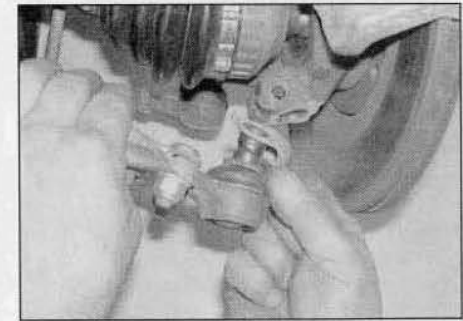

2.11 When the balljoint is released, remove the protector plate from the balljoint shank

be  
ave  
ing  
and  
wer  
the  
haft  
able  
ired  
  
on  
fts  
as  
ult.  
ble,  
the  
the

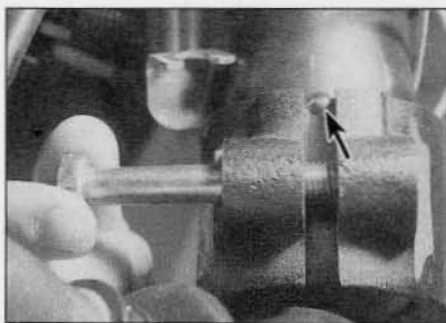

**2.16** Ensure the swivel hub clamp is aligned with the lug (arrowed) on the strut prior to inserting the clamp bolt

swivel hub. Insert the swivel hub-to-suspension strut clamp bolt, then fit a new nut to the clamp bolt, and tighten it to the specified torque (see illustration).

**17** Refit the protector plate to the lower arm balljoint then, using the method employed on removal, locate the balljoint shank in the swivel hub, ensuring that the lug on the protector plate is correctly located in the clamp split. Insert the balljoint clamp bolt, then fit the new retaining nut and tighten it to the specified torque.

**18** Engage the track rod balljoint in the swivel hub, then fit a new retaining nut and tighten it to the specified torque.

**19** Where necessary, refit the brake disc to the hub, referring to Chapter 9 for further information. Apply a suitable locking compound to the threads of the caliper mounting bracket bolts. Slide the caliper assembly into position over the disc, then fit the mounting bolts and tighten them to the specified torque (see Chapter 9).

**20** Where applicable, refit the ABS wheel sensor as described in Chapter 9.

**21** Refit the wiring retaining bracket to the top of the swivel hub, and tighten its retaining bolt securely. Where fitted, reconnect the brake pad wear sensor wiring.

**22** Lubricate the inner face and threads of the new driveshaft retaining nut with clean engine oil, and refit it to the end of the driveshaft. Use the method employed on removal to prevent the hub from rotating, and tighten the driveshaft retaining nut to the

specified torque (see Chapter 8). Check that the hub rotates freely.

**23** Engage the locking cap with the driveshaft nut so that one of its cut-outs is aligned with the driveshaft hole. Secure the cap with the R-clip.

**24** Refit the roadwheel, then lower the vehicle to the ground and tighten the roadwheel bolts to the specified torque.

### 3 Front hub bearings – renewal

**Note 1:** The bearing is a sealed, pre-adjusted and pre-lubricated, double-row roller type, and is intended to last the car's entire service life without maintenance or attention. Never overtighten the driveshaft nut beyond the specified torque wrench setting in an attempt to 'adjust' the bearing.

**Note 2:** A press will be required to dismantle and rebuild the assembly; if such a tool is not available, a large bench vice and spacers (such as large sockets) will serve as an adequate substitute. The bearing's inner races are an interference fit on the hub; if the inner race remains on the hub when it is pressed out of the hub carrier, a knife-edged bearing puller will be required to remove it. A new bearing retaining circlip must be used on refitting.

**1** Remove the swivel hub assembly as described in Section 2.

**2** Support the swivel hub securely on blocks or in a vice. Using a tubular spacer which bears only on the inner end of the hub flange, press the hub flange out of the bearing. If the bearing's outboard inner race remains on the hub, remove it using a bearing puller (see note above).

**3** Extract the bearing retaining circlip from the inner end of the swivel hub assembly (see illustration).

**4** Where necessary, refit the inner race back in position over the ball cage, and securely support the inner face of the swivel hub. Using a tubular spacer which bears only on the inner race, press the complete bearing assembly out of the swivel hub.

**5** Thoroughly clean the hub and swivel hub, removing all traces of dirt and grease, and polish away any burrs or raised edges which might hinder reassembly. Check both for cracks or any other signs of wear or damage, and renew them if necessary. Renew the circlip, regardless of its apparent condition.

**6** On reassembly, apply a light film of oil to the bearing outer race and hub flange shaft, to aid installation of the bearing.

**7** Securely support the swivel hub, and locate the bearing in the hub. Press the bearing fully into position, ensuring that it enters the hub squarely, using a tubular spacer which bears only on the bearing outer race. Note that on September 2002 models onward with ABS, the bearing is equipped with a magnetic encoder on its inboard face. When fitting the bearing ensure this face is inboard adjacent to the ABS wheel speed sensor (see illustration). Take care not to damage this encoder, or place it adjacent to a magnetic source. Ensure the encoder face is clean.

**8** Once the bearing is correctly seated, secure the bearing in position with the new circlip, ensuring that it is correctly located in the groove in the swivel hub. **Note:** On September 2002 models onward with ABS, align the gap between the ends of the circlip with the gap for the ABS wheel speed sensor.

**9** Securely support the outer face of the hub flange, and locate the swivel hub bearing inner race over the end of the hub flange. Press the bearing onto the hub, using a tubular spacer which bears only on the inner race of the hub bearing, until it seats against the hub shoulder. Check that the hub flange rotates freely, and wipe off any excess oil or grease.

**10** Refit the swivel hub assembly as described in Section 2.

### 4 Front suspension strut – removal and refitting

**Note:** All nuts disturbed on removal must be renewed as a matter of course. These nuts have threads which are pre-coated with locking compound (this is only effective once), and include the swivel hub clamp bolt nut, and the anti-roll bar connecting link nut. Suitable spring compressor tools will be required for this operation.

#### Removal

**1** Chock the rear wheels, apply the handbrake, then jack up the front of the vehicle and support it on axle stands (see *Jacking and vehicle support*). Remove the appropriate roadwheel.

**2** If the left-hand suspension strut is to be removed on September 2002 models onward, remove the engine management ECU and its mounting bracket as described in the relevant part of Chapter 4, for access to the strut upper mounting.

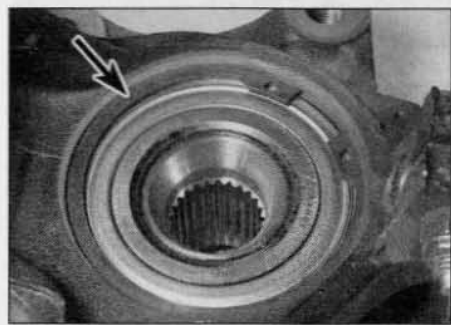

**3.3** Front hub bearing retaining circlip (arrowed)

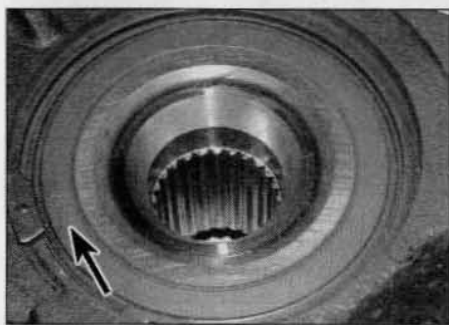

**3.7** On later models, take care not to damage the seal in the bearing (arrowed) – it contains the encoder for the wheel speed sensor



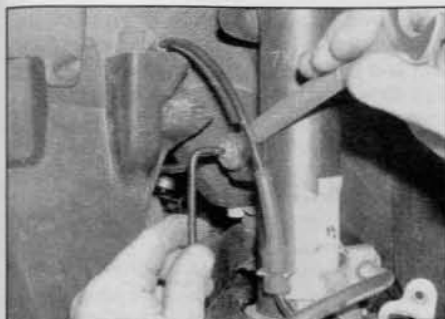

4.5 Unscrew the nut securing the anti-roll bar connecting link to the strut

3 Slacken and remove the bolt securing the wiring retaining bracket to the top of the swivel hub.

4 Unclip the brake flexible hydraulic hose and any wiring from the strut.

5 Unscrew the nut (and recover the washer) securing the anti-roll bar connecting link to the strut, and position the link clear of the strut. Counterhold the link with an Allen key to prevent rotation as the nut is undone (see illustration). Discard the nut – a new one must be used on refitting.

6 Undo the nut and withdraw the swivel hub-to-suspension strut clamp bolt. Discard the nut – a new one must be used on refitting (see illustration).

7 The coil spring must now be compressed to enable the strut to be removed. Working under the wheel arch, fit suitable spring compressors to the spring and compress the spring sufficiently to enable the lower end of the strut to be disconnected from the swivel hub (see illustration). Ensure that the compressors used are of a type that incorporate a method for positively locking them to the spring (usually by a small clamp bolt). Any other type may slip off or slide round the spring as they are tightened.

8 Tap a small chisel into the split in the swivel hub to spread the hub (see illustration).

9 Slacken and remove the three suspension strut upper mounting bolts, then withdraw the strut from under the wheel arch (see illustration).

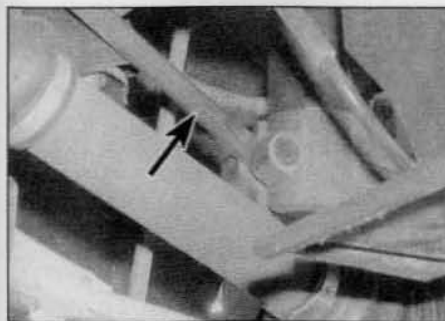

4.8 Tap a small chisel (arrowed) into the split in the swivel hub to spread the hub

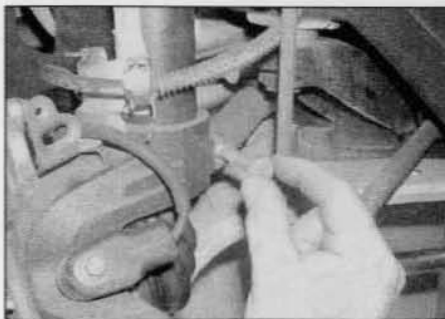

4.6 Unscrew the nut and remove the swivel hub-to-suspension strut clamp bolt

### Refitting

10 With the coil spring compressors in place, as during removal, manoeuvre the strut assembly into position. Ensure that the top mounting plate locating pin is correctly located in the corresponding hole in the body and that the mounting plate is correctly orientated. On models with manual steering, the orientation lug on the mounting rubber must be toward the rear of the vehicle. On models with power steering, the orientation lug must be toward the front of the vehicle (see illustration 4.9).

11 Engage the lower end of the strut with the swivel hub, aligning the split in the hub with the lug on the base of the strut. Also ensure that the stop bosses on the strut are in contact with the top surface of the swivel hub.

12 Insert the strut upper mounting bolts, and tighten them to the specified torque.

13 Insert the swivel hub-to-suspension strut clamp bolt, fit a new nut to the clamp bolt, and tighten it to the specified torque.

14 Carefully slacken and then remove the spring compressors.

15 Where applicable, refit the engine management ECU and mounting bracket as described in the relevant Part of Chapter 4.

16 Reconnect the anti-roll bar connecting link to the strut. Fit a new nut to the connecting link, and tighten it to the specified torque.

17 Refit the wiring retaining bracket to the top of the swivel hub, and clip the flexible hose and wiring to their locations on the strut.

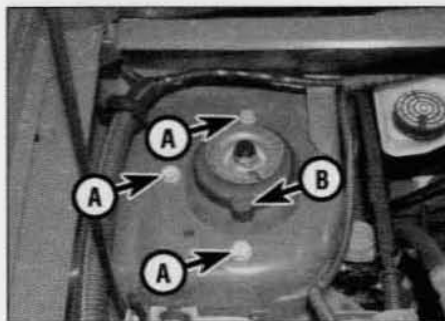

4.9 Suspension strut upper mounting bolts (A) and orientation lug (B)

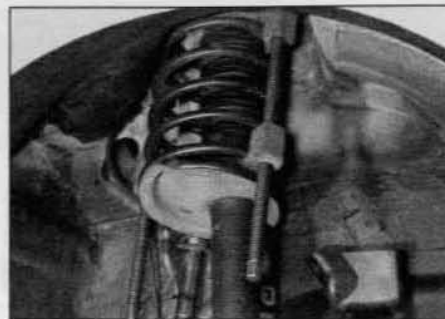

4.7 Coil spring compressors fitted to strut spring

18 Refit the roadwheel, then lower the vehicle to the ground and tighten the roadwheel bolts to the specified torque.

### 5 Front suspension strut – overhaul



**Warning:** Before attempting to dismantle the suspension strut, a suitable tool to hold the coil spring in compression must be obtained.

Adjustable coil spring compressors which can be positively secured to the spring coils are readily available, and are recommended for this operation. Any attempt to dismantle the strut without such a tool is likely to result in damage or personal injury.

1 With the strut removed from the car as described in Section 4, clean away all external dirt then mount the unit upright in a vice.

2 If not already in place, fit the spring compressors to the coils of the spring. Ensure that the compressors used are of a type that incorporate a method for positively locking them to the spring (usually by a small clamp bolt). Any other type may slip off or slide round the spring as they are tightened. Tighten the compressors until the load is taken off the spring seats.

3 Remove the protective cap then unscrew the piston rod nut, counterholding the piston rod with a suitable Allen key (see illustration). Note that a new nut will be required for reassembly.

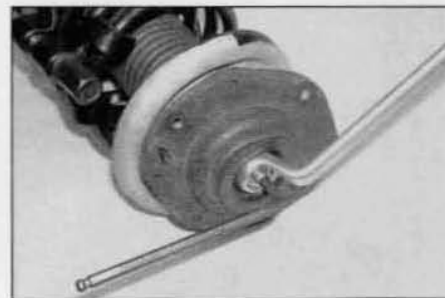

5.3 Unscrew the strut piston rod nut while counterholding the piston rod with a suitable Allen key



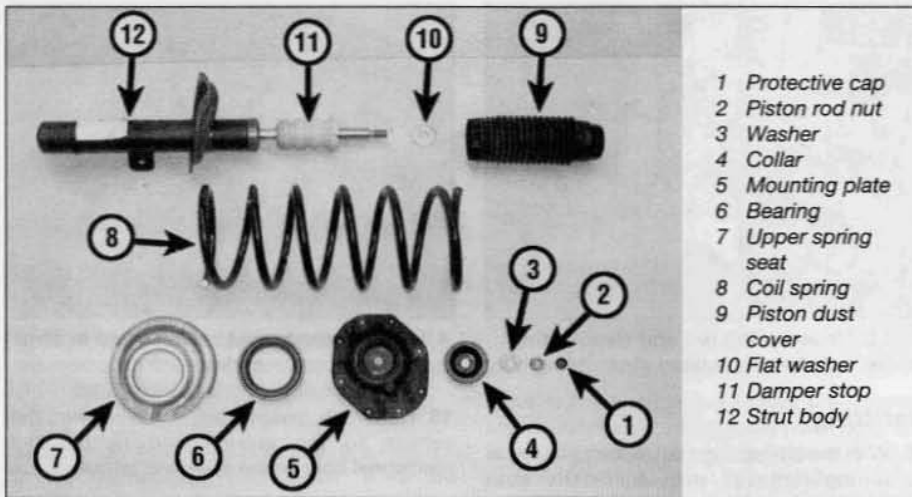

5.4 Front suspension strut components

4 Remove the nut and washer, then lift off the collar, mounting plate, bearing, upper spring seat and flat washer. Remove the coil spring, then slide off the piston dust cover and rubber damper stop (see illustration). The spring may remain in the compressed state ready for refitting to the strut. If the spring is to be renewed, release the compressors very gently and evenly until they can be removed and fitted to the new spring.

5 With the strut assembly now completely dismantled, examine all the components for wear, damage or deformation, and check the bearing for smoothness of operation. Renew any components as necessary.

6 Examine the strut body for signs of fluid leakage or damage, and the piston for signs of pitting or scoring. Test the operation of the strut, while holding it in an upright position, by moving the piston through a full stroke and then through short strokes of 50 to 100 mm. In both cases, the resistance felt should be smooth and continuous. If the resistance is jerky, or uneven, or if there is any visible sign of wear or damage, renewal is necessary.

7 If any doubt exists about the condition of the coil spring, carefully remove the spring compressors, and check the spring for distortion and signs of cracking. Renew the spring if it is damaged or distorted.

8 To reassemble the strut, follow the accompanying photos. Be sure to stay in order, and carefully read the captions (see illustrations).

9 Refit the strut to the car as described in Section 4 on completion of reassembly.



5.8a Pull the piston rod out as far as it will go and fit the damper stop



5.8b Fit the piston dust cover . . .



5.8c . . . followed by the compressed spring . . .

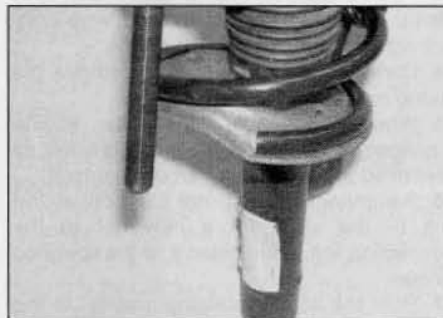

5.8d . . . ensuring that the end of the lower coil is located correctly in the lower seat



5.8e Place the flat washer in position . . .



5.8f . . . followed by the upper spring seat . . .



5.8g . . . bearing . . .



5.8h . . . and mounting plate



5.8i Locate the collar over the mounting plate ...



5.8j ... fit the upper washer ...



5.8k ... then fit and tighten the piston rod nut

## 6 Front suspension lower arm – removal, overhaul and refitting

**Note 1:** All nuts disturbed on removal must be renewed as a matter of course. These nuts have threads which are pre-coated with locking compound (this is only effective once), and include the lower arm balljoint clamp bolt nut.

**Note 2:** Two different types of lower suspension arm may be encountered; type 1 being a steel pressing with a removable lower arm balljoint, and type 2 being a steel forging with fixed lower arm balljoint. The photos in this Section depict the type 1 suspension arm.

### Removal

1 Chock the rear wheels then jack up the front of the vehicle and support it on axle stands (see *Jacking and vehicle support*). Remove the appropriate front roadwheel.

2 Slacken and remove the nut, then withdraw the lower arm balljoint clamp bolt from the swivel hub. Discard the nut – a new one must be used on refitting.

3 Slacken and remove the lower arm front pivot bolt and nut. Recover the nut from its housing if it is loose (see *illustration*).

4 Unscrew the two bolts securing the lower arm rear mounting bush to the subframe, noting that the larger bolt also secures the anti-roll bar mounting clamp (counterhold the nut if necessary) (see *illustration*). Recover the nut from the top of the anti-roll bar mounting clamp.



6.3 Remove the lower arm front pivot bolt ...

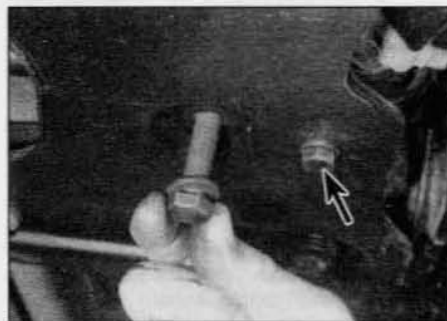

6.4 ... and the two rear mounting bush bolts (second bolt arrowed) ...



6.6 ... then remove the lower arm from the vehicle

5 Tap a small chisel into the split on the swivel hub to spread the hub slightly, and allow the balljoint shank to be withdrawn. Withdraw the inner end of the arm from the subframe and release the balljoint from the swivel hub. Remove the protector plate which is fitted to the balljoint shank.

6 Manoeuvre the lower arm assembly out from underneath the vehicle (see *illustration*).

### Overhaul

**Note:** If the lower arm balljoint on the type 1 suspension arm is to be renewed, new retaining nuts must be used on refitting.

7 Thoroughly clean the lower arm and the area around the arm mountings, removing all traces of dirt and underseal if necessary, then check carefully for cracks, distortion or any other signs of wear or damage, paying particular attention to the pivot bushes, and renew components as necessary. Due to the number of special tools required (including a press), pivot bush renewal should be entrusted to a dealer or suitably-equipped garage.

8 Check that the lower arm balljoint moves freely, without any sign of roughness; check also that the balljoint dust cover shows no sign of deterioration, and is free from cracks and splits. If renewal is necessary (which is only possible on the type 1 suspension arm), slacken and remove its retaining bolts, and remove the balljoint from the arm. Fit the new balljoint, and insert its retaining bolts. Fit new nuts to the bolts, and tighten them to the specified torque.

9 Examine the shank of the lower arm pivot bolt for signs of wear or scoring, and renew if necessary.

### Refitting

10 Manoeuvre the lower arm assembly into position, refit the protector plate to the lower arm balljoint, then locate the balljoint shank in the swivel hub. Ensure that the lug on the protector plate is correctly located in the clamp split.

11 Insert the balljoint clamp bolt, then fit the new retaining nut and tighten it to the specified torque.

12 Refit the front pivot bolt, tightening it finger-tight only. Ensure that the nut is located in its housing.

13 Refit the rear pivot bush retaining bolts and nut, ensuring that the bush bracket is located between the subframe and the anti-roll bar clamp. Tighten the fixings to the specified torque.

14 Refit the roadwheel, then lower the vehicle and tighten the roadwheel bolts to the specified torque. Rock the vehicle to settle the disturbed components, then tighten the lower arm front pivot bolt to the specified torque.

## 7 Front suspension lower arm balljoint – removal and refitting

**Note 1:** Two different types of lower suspension arm may be encountered; type 1 being a steel pressing with a removable lower



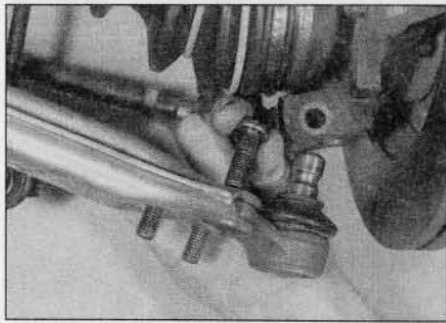

7.5a Remove the three retaining bolts . . .

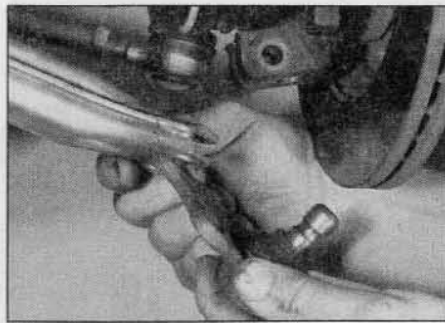

7.5b . . . and remove the lower arm balljoint

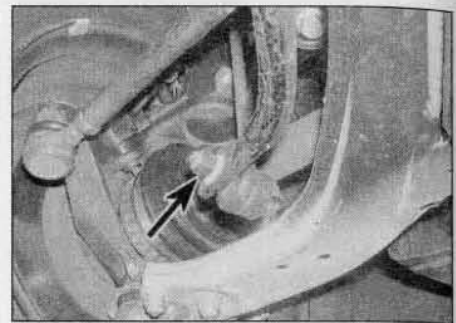

8.2 Undo the nut and washer (arrowed) securing the left-hand connecting link to the anti-roll bar

arm balljoint, and type 2 being a steel forging with fixed lower arm balljoint. The following procedures are applicable only to the type 1 lower suspension arm.

**Note 2:** A new balljoint clamp bolt nut, and new balljoint securing nuts must be used on refitting.

### Removal

1 Chock the rear wheels then jack up the front of the vehicle and support it on axle stands (see *Jacking and vehicle support*). Remove the appropriate front roadwheel.

2 Slacken and remove the nut, then withdraw the lower suspension arm balljoint clamp bolt from the swivel hub. Discard the nut – a new one must be used on refitting.

3 Tap a small chisel into the split on the swivel hub to spread the hub slightly, and allow the balljoint shank to be withdrawn. Pull the lower suspension arm downwards to release the balljoint shank from the swivel hub. To do this it will be necessary to use a long bar and block of wood which will engage under the front subframe. Attach the bar to the suspension arm, preferably with a chain, or alternatively with a stout strap or rope. Lever down on the bar to release the balljoint from the swivel hub (see illustration 2.10b).

4 Once the balljoint is free, remove the protector plate which is fitted to the balljoint shank.

5 Slacken and remove the three nuts, then withdraw the balljoint retaining bolts and remove the balljoint from the lower arm (see illustrations). Discard the nuts – new ones must be used on refitting.

6 Check that the lower arm balljoint moves freely, without any sign of roughness. Check also that the balljoint dust cover shows no sign of deterioration, and is free from cracks and splits. Renew worn or damaged components as necessary.

### Refitting

7 Locate the balljoint in the end of the suspension arm, and insert the three retaining bolts. Fit new nuts to the bolts, and tighten them to the specified torque.

8 Refit the protector plate to the lower arm balljoint then, using the method employed on

removal, locate the balljoint shank in the swivel hub, ensuring that the lug on the protector plate is correctly located in the clamp split. Insert the balljoint clamp bolt (from the rear of the swivel hub), then fit the new retaining nut and tighten it to the specified torque.

9 Refit the roadwheel, then lower the vehicle and tighten the roadwheel bolts to the specified torque.

## 8 Front suspension anti-roll bar – removal and refitting



**Note:** All nuts disturbed on removal must be renewed as a matter of course. These nuts have threads which are pre-coated with locking compound (this is only effective once), and include the anti-roll bar connecting link nuts and the intermediate shaft pinch-bolt nut (and pinch-bolt).

### Removal

1 Firmly apply the handbrake, then jack up the front of the car and support it securely on axle stands (see *Jacking and vehicle support*). Position the roadwheels in the straight-ahead position, then remove both front roadwheels.

2 Undo the nut and washer securing the left-hand connecting link to the anti-roll bar, and position the link clear of the bar (see illustration). Repeat the procedure on the right-hand side.

3 Unclip the clutch cable from the brackets on the subframe.

4 Where fitted, release the power steering fluid pipe support clips from the engine and transmission.

5 Working in the engine compartment, unscrew the securing nut from the intermediate shaft-to-steering gear pinion pinch-bolt, then carefully tap the pinch-bolt from the universal joint – discard the pinch-bolt and nut, new ones must be used on refitting. Pull off the metal clip securing the intermediate shaft to the pinion.

6 Make alignment marks on the universal joint and the steering gear pinion, then push the universal joint upwards to separate it from the

pinion. Engage the steering lock to prevent the steering wheel from turning while the shaft is disconnected.

7 Unscrew the nut and remove the bolt securing the engine/transmission rear mounting connecting link to the mounting on the rear of the cylinder block.

8 Make a final check to ensure that all relevant pipes, hoses and wiring harnesses have been released and moved clear of the subframe to allow the rear of the subframe to be lowered.

9 Accurately measure and record the position of the subframe, both laterally and horizontally with respect to the chassis members and underbody. In practice, there will be marks made on the subframe by the retaining bolts and these can be used as a very accurate guide to correct location when refitting.

10 Slacken and remove the four subframe rear mounting bolts. Loosen the two subframe front mounting bolts by a few turns, until it is possible to lower the rear edge of the subframe approximately 65.0 mm. Wedge a block of wood between the rear of the subframe and the vehicle underbody to hold the subframe in this position.

11 Slacken the two anti-roll bar mounting clamp retaining bolts, and recover the nuts from the top of the clamps. Remove both clamps from the subframe.

12 Manoeuvre the anti-roll bar out from underneath the vehicle, and remove the mounting bushes from the bar.

13 Carefully examine the anti-roll bar components for signs of wear, damage or deterioration, paying particular attention to the mounting bushes. Renew worn components as necessary.

### Refitting

14 Fit the rubber mounting bushes to the anti-roll bar, ensuring that the lugs on the inside of each bush engage with the corresponding cut-outs in the anti-roll bar. The bushes are correctly positioned when the alignment marks on the edges of the bushes are aligned with the paint marks on the anti-roll bar.

15 Offer up the anti-roll bar, and manoeuvre it into position on the subframe. Refit the



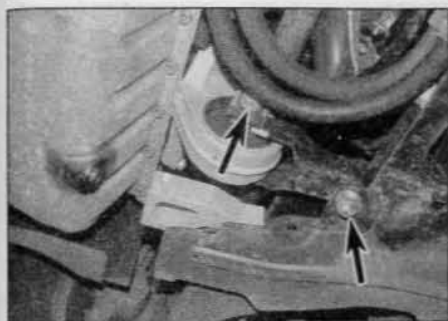

**10.2** Rear engine/transmission mounting connecting link attachments (arrowed)



**10.11a** Front subframe left-hand rear mounting bolts (arrowed) ...

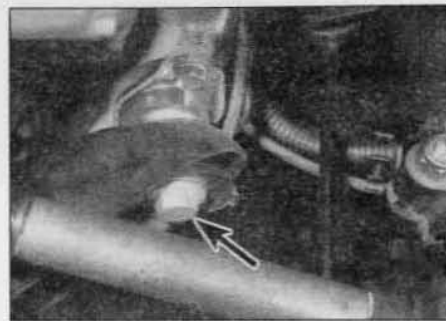

**10.11b** ... and front mounting bolt (arrowed)

mounting clamps, ensuring that their ends are correctly located in the hooks on the subframe, and refit the retaining bolts and nuts. Ensure that the bush markings are still aligned with the paint marks on the bar, then tighten the mounting clamp retaining bolts to the specified torque.

**16** The remainder of the refitting is a reversal of the removal procedure, noting the following points:

- a) All nuts disturbed on removal must be renewed as a matter of course. These nuts have threads which are pre-coated with locking compound (this is only effective once), and include the anti-roll bar connecting link nuts and the intermediate shaft pinch-bolt nut (and pinch-bolt).
- b) Ensure that the subframe is correctly positioned by using the measurements made during removal, or with reference to the marks made by the retaining bolts.
- c) Tighten all nuts and bolts to the specified torque settings (where given).
- d) Ensure that the metal clip is correctly refitted to the steering intermediate shaft universal joint and that the marks made on removal are aligned.
- e) Fit a new intermediate shaft pinch-bolt and nut, ensuring that the lugs on the bolt engage with the cut-outs in the universal joint.
- f) On completion have the front wheel alignment checked and where necessary adjusted (see Section 24).

### 9 Front suspension anti-roll bar connecting link – removal and refitting

**Note:** New connecting link securing nuts must be used on refitting.

#### Removal

- 1** Firmly apply the handbrake, then jack up the front of the car and support it securely on axle stands (see *Jacking and vehicle support*). Remove the appropriate front roadwheel.
- 2** Slacken and remove the upper and lower connecting link retaining nuts and washers, and remove the link from the vehicle.

- 3** Examine the connecting link for signs of damage, paying particular attention to the mounting bushes or balljoints (as applicable), and renew the link if necessary. It is not possible to renew the bushes or balljoints separately. Note that the connecting link retaining nuts must be renewed as a matter of course.

#### Refitting

**4** Refitting is a reversal of the removal procedure, using new retaining nuts and tightening them to the specified torque.

### 10 Front suspension subframe – removal and refitting

**Note:** All nuts disturbed on removal must be renewed as a matter of course. These nuts have threads which are pre-coated with locking compound (this is only effective once), and include the steering gear bolt nuts.

#### Removal

- 1** Firmly apply the handbrake, then jack up the front of the car and support it securely on axle stands (see *Jacking and vehicle support*). Remove both front roadwheels.
- 2** Unscrew and remove the bolt securing the engine/transmission rear mounting connecting link to the mounting on the rear of the cylinder block. Remove the bolt securing the rear mounting link to the bracket on the subframe and withdraw the link (see illustration).
- 3** On models with power steering, undo the bolt(s) securing the power steering fluid pipe(s) to the mounting bracket(s) on the subframe, and free the pipe(s) from any subframe retaining clips. Unclip the clutch cable from the brackets on the subframe.
- 4** Where applicable, carefully prise the plastic cap, then undo the pivot bolt securing the gearchange linkage bellcrank to the subframe.
- 5** Slacken and remove the steering gear mounting bolts, and recover the nuts. Withdraw the mounting bolts, and recover the spacers from the subframe apertures. Secure the steering gear to the exhaust front pipe using a large cable tie or similar.

**6** Slacken and remove the suspension lower arm front pivot bolt and nut on both sides. Recover the nut from its housing if it is loose.

**7** Unscrew the two bolts securing the suspension lower arm rear mounting bush to the subframe on each side, noting that the larger bolt also secures the anti-roll bar mounting clamp (counterhold the nut if necessary). Recover the nut from the top of each anti-roll bar mounting clamp.

**8** Release the inner ends of both suspension lower arms from their locations in the subframe.

**9** Place a jack and a suitable block of wood under the subframe to support the subframe as it is lowered.

**10** Accurately measure and record the position of the subframe, both laterally and horizontally with respect to the chassis members and underbody. In practice, there will be marks made on the subframe by the retaining bolts and these can be used as a very accurate guide to correct location when refitting.

**11** Slacken and remove the four rear subframe mounting bolts, and the two front bolts, then carefully lower the subframe assembly out of position and remove it from underneath the vehicle (see illustrations). Ensure that the subframe assembly does not catch the power steering pipes as it is lowered out of position.

#### Refitting

**12** Refitting is a reversal of the removal procedure, noting the following points:

- a) Ensure that the subframe is correctly positioned by using the measurements made during removal, or with reference to the marks made by the retaining bolts.
- b) All nuts disturbed on removal must be renewed as a matter of course. These nuts have threads which are pre-coated with locking compound (this is only effective once) and include the steering gear mounting bolt nuts.
- c) Tighten all nuts and bolts to the specified torque settings (where given).
- d) On completion have the front wheel alignment checked and where necessary adjusted (see Section 24).

## 11 Rear hub assembly – removal and refitting



**Note:** Do not remove the hub assembly unless it is absolutely necessary. A puller will be required to draw the hub assembly off the stub axle, and the hub bearing will be damaged by the removal procedure. A complete new hub assembly, hub nut, and a new hub cap must be used on refitting.

### Removal

- 1 Remove the relevant rear brake drum and, on models with ABS, the rear wheel speed sensor as described in Chapter 9.
- 2 Using a hammer and a large flat-bladed screwdriver, carefully tap and prise the cap out of the centre of the hub. Discard the cap – a new one must be used on refitting. Using a hammer and a chisel-nosed tool, tap up the staking securing the hub retaining nut to the groove in the stub axle.
- 3 Using a socket and long bar, slacken and remove the rear hub nut, and withdraw the thrustwasher (where fitted). Discard the hub nut – a new nut must be used on refitting.
- 4 Using a puller, draw the hub assembly off the stub axle, along with the outer bearing. With the hub removed, use a bearing puller to draw the inner bearing inner race off the stub axle, then remove the flanged hub spacer, noting which way around it is fitted. On later models a plain spacer is used which can be fitted either way round.

5 With the hub removed, examine the stub axle shaft for signs of wear or damage. If stub axle shaft is worn, it will be necessary to renew the complete trailing arm, as the shaft is not available separately. Trailing arm renewal entails the use of numerous special tools and must be entrusted to a Peugeot/Citroën dealer.

6 Obtain a new hub assembly, hub nut and hub cap for refitting. Note that there are two different types of hub nut, one with a separate thrustwasher, and one with an integral thrustwasher. The two types are interchangeable, but there is a different torque setting for each type.

### Refitting

- 7 Lubricate the stub axle shaft with clean engine oil, then slide on the spacer, ensuring it is fitted the correct way round on early versions.
- 8 Slide the hub assembly onto the stub axle and tap it into position using a tubular drift.
- 9 Fit the thrustwasher (where applicable) then screw on the new hub nut. Do not use the separate thrustwasher if the new nut is of the type with an integral thrustwasher. Lubricate the threads and contact faces of the hub nut and tighten the nut to the specified torque according to type. Stake the nut firmly into the groove on the stub axle to secure it in position, then tap the new hub cap into place in the centre of the hub (see illustrations).

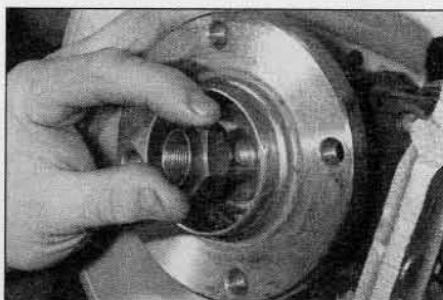

11.9a Fit the thrustwasher (where applicable) and new hub nut, and tighten to the specified torque

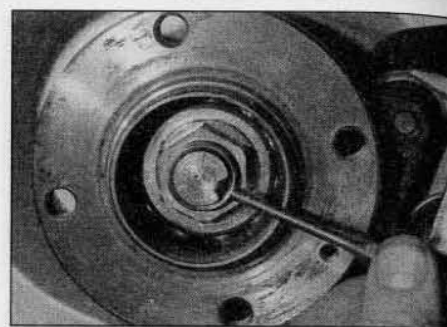

11.9b Using a hammer and suitable punch ...

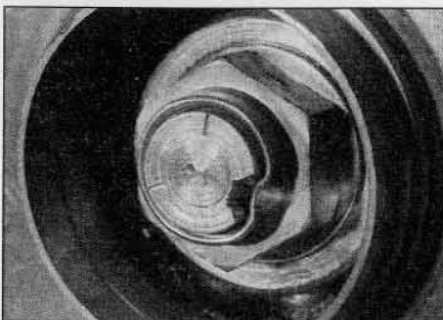

11.9c ... stake the hub nut firmly into the stub axle groove ...



11.9d ... then fit the new hub cap

- 10 On completion, refit the brake drum and ABS wheel sensor (where applicable) as described in Chapter 9.

## 12 Rear hub bearings – renewal



**Note:** The bearing is intended to last the car's entire service life without maintenance or attention. Never overtighten the hub nut beyond the specified torque setting in an attempt to 'adjust' the bearings.

- 1 The rear hub bearing is integral with the rear hub, and it is not possible to renew the hub bearing separately. If the bearing is worn, the complete rear hub assembly must be renewed. See Section 11 for hub removal and refitting procedures.

## 13 Rear suspension components – general

Although it is possible to remove the rear suspension torsion bars, trailing arms and anti-roll bar independently of the complete rear axle assembly, it is essential to have certain special tools available to complete the work successfully.

Due to the complexity of the tasks, and the requirement for special tools to accurately set the suspension geometry on refitting, the removal and refitting of individual rear suspension components is considered to be

beyond the scope of DIY work, and should be entrusted to a Peugeot/Citroën dealer.

Procedures for removal and refitting of the rear shock absorbers, and the complete rear suspension assembly are given in Sections 14 and 15 respectively.

## 14 Rear shock absorber – removal, testing and refitting



**Note:** New shock absorber mounting nuts must be used on refitting.

### Removal

- 1 Drive the rear of the vehicle onto ramps, then apply the handbrake and chock the front wheels.
- 2 Do not support the vehicle with the trailing arms hanging unsupported.
- 3 Counterhold the bolts, and unscrew the

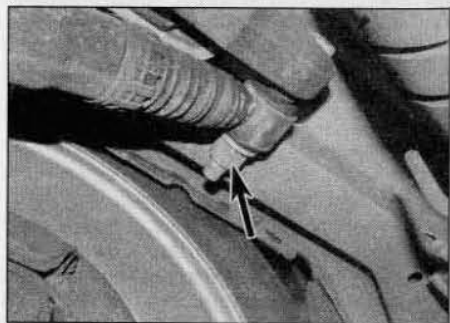

14.3a Slacken and remove the shock absorber upper mounting nut (arrowed) ...



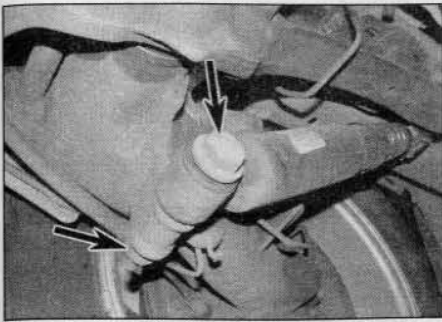

14.3b ... and lower mounting nut and bolt (arrowed)

shock absorber upper and lower securing nuts (see illustrations). Recover the washers.  
**4** Tap the bolts from the mountings to free the shock absorber, then withdraw the unit from under the vehicle.

### Testing

**5** Examine the shock absorber for signs of fluid leakage or damage. Test the operation of the shock absorber, while holding it in an upright position, by moving the piston through a full stroke and then through short strokes of 50 to 100 mm. In both cases, the resistance felt should be smooth and continuous. If the resistance is jerky, or uneven, or if there is any visible sign of wear or damage, renewal is necessary.

**6** Also check the rubber mounting bushes for damage and deterioration. New bushes can be fitted using a long bolt, nut and spacers to draw the bush into position. Lubricate the new bush with soapy water to aid fitting.

**7** Inspect the shanks of the mounting bolts for signs of wear or damage, and renew as necessary.

### Refitting

**8** Prior to refitting the shock absorber, mount it upright in the vice, and operate it fully through several strokes in order to prime it. Apply a smear of multi-purpose grease to both the shock absorber mounting bolts.

**9** Manoeuvre the shock absorber into position, and insert its mounting bolts (with washers in place). Note that the bolts fit from

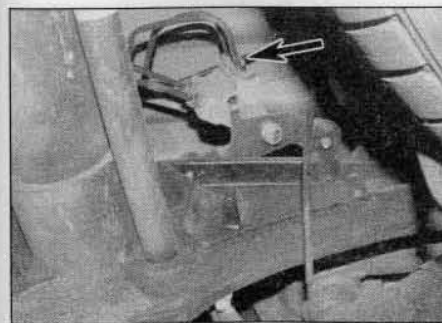

15.8 Unscrew the two brake inlet pipe union nuts at the brake pipe connecting block

the inside of the vehicle, ie, the nuts fit on the roadwheel side of the shock absorber.

**10** Fit the washers and new nuts to the mounting bolts, but do not tighten the fixings at this stage.

**11** Measure the distance between the shock absorber bolt centres, and load the vehicle (by adding weight to the luggage compartment) until a distance of approximately 315.0 mm (Van models), or 340.0 mm (Multispace and Combi models) is obtained between the bolt centres. Tighten the shock absorber mounting nuts and bolts to the specified torque.

**12** Drive the vehicle off the ramps.

## 15 Rear axle assembly – removal and refitting

### Removal

**1** Disconnect the battery negative terminal (refer to *Disconnecting the battery* in the Reference Chapter).

**2** Firmly chock the front wheels, then jack up the rear of the vehicle and support it on axle stands (see *Jacking and vehicle support*). Remove both rear roadwheels.

**3** Remove the relevant exhaust system components and heat shield(s) as described in the relevant Part of Chapter 4.

**4** Referring to Chapter 9, disconnect the handbrake cables from the equaliser plate at the handbrake lever.

**5** From underneath the vehicle, work along the length of each handbrake cable, and free them from the retaining clips which secure them to the vehicle underbody. Note the routing of the cables to ensure correct refitting.

**6** On vehicles equipped with ABS, disconnect the ABS wheel speed sensors at the wiring connectors located just forward of the rear axle assembly. Free the cables from the retaining clips on the underbody.

**7** To minimise brake hydraulic fluid loss, remove the master cylinder reservoir filler cap, and then tighten it down onto a piece of polythene, to obtain an airtight seal.

**8** Wipe clean the area around the brake pipe connecting block or pressure regulating valve and unscrew the union nuts of the two brake inlet pipes (see illustration). Carefully withdraw the brake pipes from the connecting block or regulating valve and plug or cap the pipe ends and the orifices. Release the brake pipe leading to the left-hand rear brake from its clips on the underbody.

**9** Make a final check that all necessary components have been disconnected and positioned so that they will not hinder the removal procedure, then position a trolley jack beneath the centre of the rear axle assembly. Raise the jack until it is supporting the weight of the axle.

**10** Using a long-reach Torx bit, slacken and remove the rear axle rear mounting bolt on each side, accessible through the hole in the

axle side-member just in front of the shock absorber upper mounting.

**11** Slacken and remove the two retaining bolts securing each front mounting assembly to the underbody.

**12** Lower the jack and axle assembly out of position, and remove it from underneath the car.

**13** Examine the rear axle mountings for signs of damage or deterioration of the mounting rubber, and renew if necessary. Note that all four mountings should be renewed as a set; do not renew the mountings individually.

### Refitting

**14** Refitting is a reversal of the removal procedure, bearing in mind the following points:

- Take care not to crush the brake pipes when positioning the axle assembly under the body.
- Raise the rear axle assembly into position, and tighten the mounting retaining bolts to their specified torque settings.
- Ensure that the brake pipes, handbrake cables and wiring (as applicable) are correctly routed, and retained by all the necessary retaining clips.
- Tighten the brake pipe union nuts.
- Reconnect and adjust the handbrake cables as described in Chapter 9.
- Bleed the braking system hydraulic circuit as described in Chapter 9.

## 16 Vehicle ride height – checking

Checking of the vehicle ride height requires the use of special tools to accurately compress the suspension in a suspension checking bay.

The operation should be entrusted to a Peugeot/Citroën dealer, as it not possible to carry out checking accurately without the use of the appropriate tools.

## 17 Steering wheel – removal and refitting

### Models without an airbag

#### Removal

**1** Set the front wheels in the straight-ahead position, and release the steering lock by inserting the ignition key.

**2** Carefully ease off the steering wheel centre pad.

**3** Slacken the steering wheel retaining bolt. Do not fully remove the bolt at this stage.

**4** Tap the wheel upwards near the centre, using the palm of your hand, or twist it from side-to-side, whilst pulling to release it from the shaft splines.



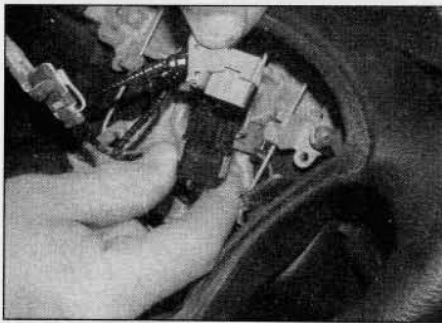

**17.9 Separate the two halves of the horn wiring connector**

5 Once the wheel is released, remove the bolt then mark the steering wheel and steering column shaft in relation to each other. Withdraw the steering wheel from the column shaft.

**Refitting**

6 Refitting is a reversal of removal, noting the following points:

- a) Ensure that the indicator switch stem is in its central position (failure to do this could lead to the steering wheel lug breaking the switch tab) then engage the wheel with the column splines, aligning the mark made on removal.
- b) Tighten the steering wheel retaining bolt to the specified torque.

**Models with an airbag**

**Removal**

7 Remove the airbag unit as described in Chapter 12.

8 Set the front wheels in the straight-ahead position, and release the steering lock by inserting the ignition key.

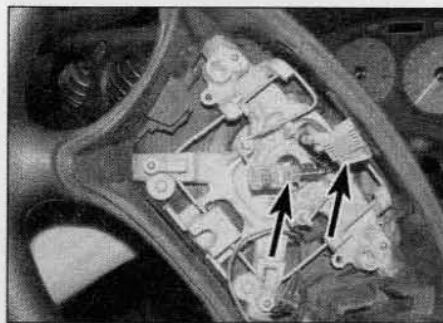

**17.13 Feed the wiring harness (arrowed) through the steering wheel as it is withdrawn**

9 On later models, lift the horn wiring connector from the slot on the side of the steering wheel and separate the two halves of the connector (see illustration).

10 Slacken the steering wheel retaining bolt. Do not fully remove the bolt at this stage.

11 Tap the wheel upwards near the centre, using the palm of your hand, or twist it from side-to-side, whilst pulling to release it from the shaft splines.

12 Once the wheel is released, remove the bolt then mark the steering wheel and steering column shaft in relation to each other.

13 Carefully withdraw the steering wheel, feeding the wiring harness for the airbag rotary connector and, where applicable, the horn connector through the wheel as it is withdrawn (see illustration).

**Refitting**

14 Refitting is a reversal of removal, noting the following points:

- a) Ensure that the roadwheels are in the straight-ahead position.

- b) On early models, align the two arrows on the face of the airbag rotary connector before fitting the steering wheel.
- c) Make sure that the wiring is correctly routed through the wheel.
- d) Align the marks made on removal, and tighten the retaining bolt to the specified torque.
- e) Refit the airbag unit as described in Chapter 12.

**18 Steering column – removal, inspection and refitting**



**Note:** Where applicable, a new intermediate shaft-to-steering gear pinion nut and bolt must be used on refitting.

**Removal**

1 Disconnect the battery negative terminal (refer to *Disconnecting the battery* in the Reference Chapter).

2 Remove the steering wheel as described in Section 17.

3 Remove the fusebox cover and the undercover from beneath the fascia on the driver's side. Remove the steering column upper and lower shrouds as described in Chapter 12.

4 Disconnect the wiring for the airbag (where fitted), and the steering column controls and switches at the connectors on either side of the column (see illustration). Check that any additional wiring connectors leading to the steering column components have been disconnected.

5 Make alignment marks on the universal joint and the intermediate shaft, then unscrew the column-to-intermediate shaft pinch-bolt.

6 Unscrew the two lower steering column securing bolts.

7 Unscrew the two upper steering column securing bolts, and carefully withdraw the column from the vehicle.

8 To remove the intermediate shaft, proceed as follows. Note that on certain models, it will be necessary to jack up the front of the vehicle and support on axle stands (see *Jacking and vehicle support*) for access to the intermediate shaft-to-steering gear joint. On some models, the joint can be reached through the engine compartment.

- a) Unscrew the securing nut from the intermediate shaft-to-steering gear pinion pinch-bolt, then carefully tap the pinch-bolt from the universal joint – discard the pinch-bolt and nut, new ones must be used on refitting.
- b) Pull off the metal clip securing the intermediate shaft to the pinion.
- c) Make alignment marks on the universal joint and the steering gear pinion, then push the universal joint upwards to separate it from the pinion.
- d) Release the shaft from the pinion splines, and remove it from the vehicle.

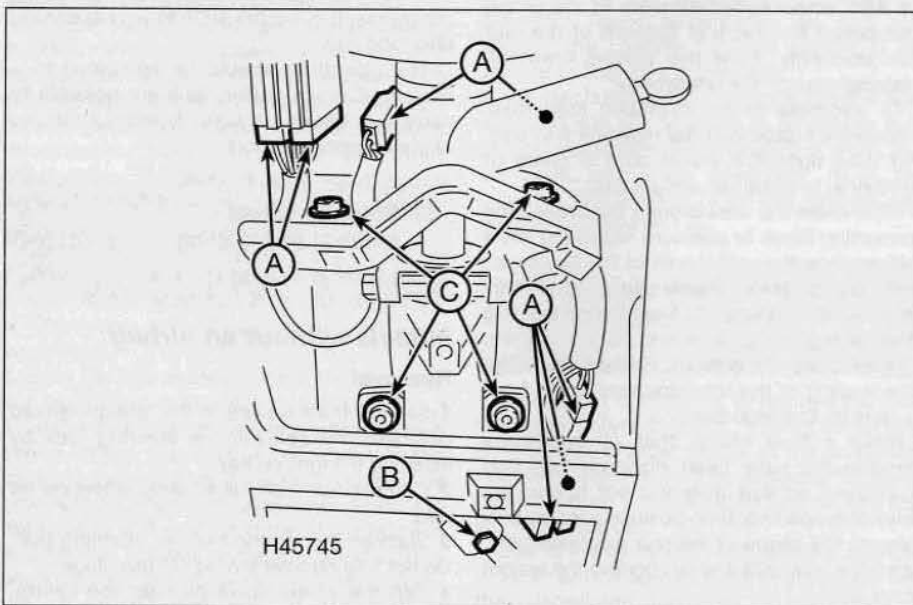

**18.4 Steering column attachments (early models shown)**

- A Wiring connectors
- B Universal joint pinch-bolt
- C Column mounting bolts

## Inspection

9 The steering column incorporates a telescopic safety feature. In the event of a front-end crash, the shaft collapses and prevents the steering wheel injuring the driver. Before refitting the steering column, examine the column and mountings for signs of damage and deformation, and renew as necessary.

10 Check the steering shaft for signs of free play in the column bushes, and check the universal joints for signs of damage or roughness in the joint bearings. If any damage or wear is found on the steering column universal joints or shaft bushes, the column must be renewed as an assembly.

11 Where disturbed, the intermediate shaft-to-steering gear pinch-bolt and nut must be renewed as a matter of course.

## Refitting

12 Where removed, refit the intermediate shaft, engaging the universal joint with the steering gear drive pinion splines (align the marks made on removal). Ensure that the metal clip is correctly refitted to the intermediate shaft-to-steering gear universal joint, then fit a new pinch-bolt and nut, ensuring that the lugs on the bolt engage with the cut-outs in the universal joint. Tighten the nut to the specified torque.

13 Manoeuvre the steering column assembly into position then, aligning the marks made prior to removal, engage the universal joint with the intermediate shaft splines.

14 Hold the column in position, and refit the steering column upper mounting bolts. Fit the lower mounting bolts and tighten all the bolts to the specified torque.

15 Refit the universal joint pinch-bolt and tighten the bolt to the specified torque.

16 Reconnect the wiring connectors under the fascia and secure them in position with the relevant clips.

17 Refit the steering column shrouds as described in Chapter 11, then refit the fusebox cover and the undercover from beneath the fascia.

18 Refit the steering wheel as described in Section 17.

## 19 Ignition switch/steering column lock – removal and refitting

### Removal

1 Disconnect the battery negative terminal (refer to *Disconnecting the battery* in the Reference Chapter).

2 Remove the fusebox cover and the undercover from beneath the fascia on the driver's side. Remove the steering column upper and lower shrouds as described in Chapter 12.

3 Trace the wiring back from the ignition switch, and disconnect its wiring connectors under the fascia. Release the harness from the retaining clips.

4 Disconnect the wiring at the electronic immobiliser receiver on the ignition switch, then unclip and remove the receiver cover from the ignition switch barrel (see illustration).

5 Slacken and remove the lock retaining screw and washer from the side of the lock. On later models the lock is secured by a tamperproof screw. Use a centre punch to mark the centre of the screw, then using a drill and an extractor, remove the screw. Obviously a new screw will be required.

6 With the ignition key inserted, turn the key so that it is aligned with the mark positioned between the A and M marks on the barrel.

7 Using a small flat-bladed screwdriver, depress the retaining lug on the side of the lock (see illustration).

8 Withdraw the lock assembly from the steering column, and feed the wiring harness through the column tube.

### Refitting

9 Feed the wiring harness through the column tube and locate the lock assembly in position. Check that the ignition key is still aligned with the mark positioned between the A and M marks, then push the lock firmly into place until the retaining lug engages.

10 Secure the lock with the retaining screw and washer, then refit the electronic immobiliser receiver. Reconnect the wiring connector to the immobiliser receiver.

11 Remove the ignition key and check that the steering lock functions correctly.

12 Reconnect the wiring connectors under the fascia and secure them in position with the relevant clips.

13 Refit the steering column shrouds as described in Chapter 11, then refit the fusebox cover and the undercover from beneath the fascia. Reconnect the battery

## 20 Steering gear assembly – removal, overhaul and refitting

**Note:** All nuts disturbed on removal must be renewed as a matter of course. These nuts have threads which are pre-coated with locking compound (this is only effective once), and include the track rod balljoint nuts, steering gear mounting bolt nuts, and the intermediate shaft pinch-bolt nut.

### Removal

1 Firmly apply the handbrake, then jack up the front of the vehicle and support on axle stands (see *Jacking and vehicle support*). Remove both front roadwheels.

2 Slacken and remove the nuts securing the steering gear track rod balljoints to the swivel hubs, and release the balljoint tapered shanks using a universal balljoint separator (see illustration).

3 Unscrew the nut from the intermediate shaft-to-steering gear pinion pinch-bolt, then carefully tap the pinch-bolt from the universal joint – discard the pinch-bolt and nut, new ones must be used on refitting. Pull off the metal clip securing the intermediate shaft to the pinion.

4 Make alignment marks on the universal joint and the steering gear pinion, then push the universal joint upwards to separate it from the pinion.

5 Unscrew and remove the bolt securing the engine/transmission rear mounting connecting link to the mounting on the rear of the cylinder block.

6 Unclip the clutch cable from the brackets on the subframe.

7 On models with power steering, undo the

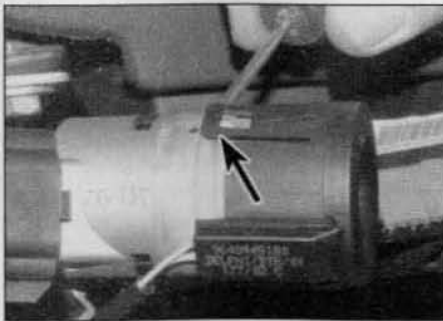

19.4 Unclip and remove the immobiliser receiver from the ignition switch barrel

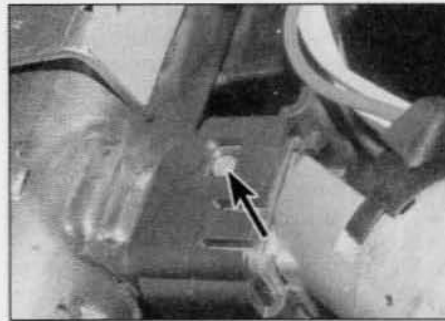

19.7 Depress the lug (arrowed) and withdraw the switch/lock from the steering column

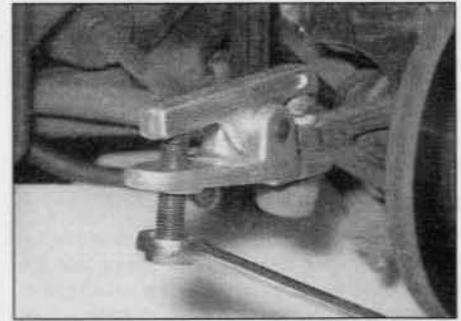

20.2 Releasing a track rod balljoint using a balljoint separator



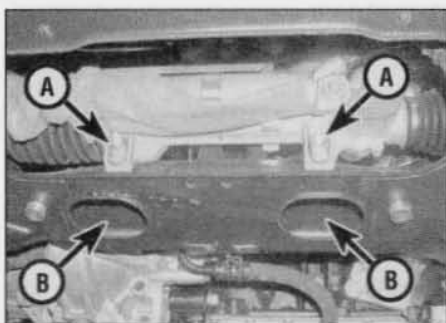

**20.13 Undo the steering gear mounting bolts (A), and recover the spacers (B) from the subframe apertures**

bolt(s) securing the power steering fluid pipe(s) to the mounting bracket(s) on the engine/transmission and subframe.

**8** Accurately measure and record the position of the subframe, both laterally and horizontally with respect to the chassis members and underbody. In practice, there will be marks made on the subframe by the retaining bolts and these can be used as a very accurate guide to correct location when refitting.

**9** Place a jack and a suitable block of wood under the front subframe to support the subframe as it is lowered.

**10** Slacken and remove the four rear subframe mounting bolts, and the two front bolts, then carefully lower the subframe slightly.

**11** On models with power steering, position a suitable container beneath the power steering gear assembly. On early models, mark the pipe unions to ensure they are correctly positioned on refitting, then unscrew the feed and return pipe union nuts from the steering gear. On later models, undo the bolt securing the fluid pipe flange plate to the rack housing and ease the flange plate from the rack. On all models, allow the power steering fluid to drain into the container. When the fluid has finished draining, suitably cover the pipe ends and the orifices in the rack to prevent dirt ingress. Note that on later models, new O-rings will be required for the pipe ends for refitting.

**12** Undo the two retaining screws (where fitted), then unclip the heat shield and remove it from the top of the steering gear assembly.

**13** Undo and remove the two steering gear mounting bolts, and recover the spacers from the subframe apertures (see illustration).

**14** Manoeuvre the steering gear out from under the right-hand wheel arch (right-hand drive models) or left-hand wheel arch (left-hand drive models).

### Overhaul

**15** Examine the steering gear assembly for signs of wear or damage, and check that the rack moves freely throughout the full length of its travel, with no signs of roughness or excessive free play between the steering gear pinion and rack. It is possible to overhaul the steering gear assembly housing components,

but this task should be entrusted to a Peugeot/Citroën dealer. The only components which can be renewed easily by the home mechanic are the track rod balljoints (see Section 23).

**16** Inspect all the steering gear fluid unions for signs of leakage, and check that all union nuts are securely tightened. Also examine the steering gear hydraulic ram for signs of fluid leakage or damage, and if necessary renew it.

### Refitting

**17** Note that all nuts disturbed on removal must be renewed as a matter of course. These nuts have threads which are pre-coated with locking compound (this is only effective once), and include the track rod balljoint nuts, and the steering gear mounting bolt nuts.

**18** Manoeuvre the steering gear assembly into position from the right-hand or left-hand side of the vehicle, as applicable.

**19** Position the spacers in the subframe apertures, then insert the mounting bolts. Tighten the mounting bolts to the specified torque.

**20** Clip the heat shield onto the top of the steering gear, and securely tighten its two retaining screws (where fitted).

**21** On models with power steering wipe clean the power steering pipes and the steering gear orifices. On early models, refit the feed and return pipe unions then refit them to their respective positions on the steering gear. Tighten the union nuts securely. On later models, locate new O-rings on the pipe ends. Locate the fluid pipe flange plate on the rack housing and secure with the retaining bolt.

**22** Raise the jack and locate the subframe in position. Ensure that the subframe is correctly positioned by using the measurements made during removal, or with reference to the marks made by the retaining bolts. Fit the front and rear subframe retaining bolts and tighten to the specified torque.

**23** Where applicable, refit the power steering fluid pipe(s) to the mounting bracket(s) on the engine/transmission and subframe.

**24** Secure the clutch cable to the brackets on the subframe.

**25** Refit the bolt securing the engine/transmission rear mounting link to the cylinder block and tighten to the specified torque (refer to the relevant Part of Chapter 2).

**26** Engage the intermediate shaft universal joint with the steering gear pinion splines (align the marks made before removal). Ensure that the metal clip is correctly refitted to the intermediate shaft-to-steering gear universal joint, then fit a new pinch-bolt and nut, ensuring that the lugs on the bolt engage with the cut-outs in the universal joint. Tighten the nut to the specified torque.

**27** Engage the track rod balljoints in the swivel hubs, then fit a new retaining nut to each one. Tighten the nuts to the specified torque.

**28** Make a final check that all cables, pipes and hoses are correctly routed, and are

securely held by all the necessary retaining clips.

**29** Refit the roadwheels, then lower the vehicle to the ground and tighten the roadwheel bolts to the specified torque.

**30** Refill the fluid reservoir and bleed the hydraulic system as described in Section 21.

**31** On completion have the front wheel alignment checked and, if necessary, adjusted (see Section 24).

### 21 Power steering system – bleeding

**1** This procedure will only be necessary when any part of the hydraulic system has been disconnected.

**2** Referring to *Weekly checks*, remove the fluid reservoir filler cap, and top-up with the specified fluid until the level is up to the MAX mark on the side of the reservoir (early models) or up to the Cold mark on the filler cap dipstick (later models).

**3** With the engine stopped, slowly move the steering from lock-to-lock approximately ten times to purge out the trapped air, then top-up the fluid until the level is again up to the MAX or Cold mark as applicable. Repeat this procedure until the fluid level in the reservoir does not drop any further.

**4** Start the engine, and allow it to idle for two or three minutes without moving the steering wheel. Switch the engine off and, if necessary, top-up the fluid again, to the MAX or Cold mark.

**5** Start the engine and slowly move the steering from lock-to-lock several times to purge out any remaining air in the system. Repeat this procedure until bubbles cease to appear in the fluid reservoir.

**6** Once all traces of air have been removed from the power steering hydraulic system, turn the engine off and allow the system to cool. Once cool, check that the fluid level is up to the MAX or Cold mark, topping-up if necessary.

### 22 Power steering pump – removal and refitting

#### Removal

**1** The power steering pump is mounted on the front facing side of the engine.

**2** Remove the auxiliary drivebelt as described in the relevant Part of Chapter 1.

**3** On later diesel engine models, release the four plastic fasteners and remove the engine cover from the top of the engine.

**4** On later petrol engine models, unbolt and remove the heat shield at the rear of the power steering pump.

**5** Unscrew the power steering fluid reservoir filler cap and empty the hydraulic fluid from



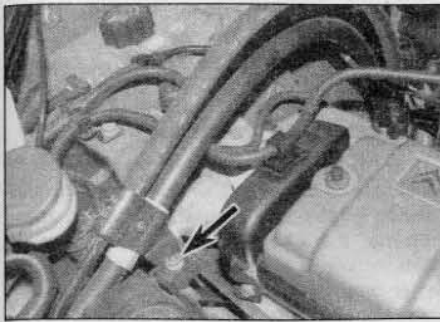

**22.7a** Power steering fluid supply pipe support bracket attachment (arrowed) on 1.4 litre petrol engines ...

the reservoir by syphoning it out using a syringe or pipette. **Note:** Do not syphon the fluid by mouth, as it is poisonous.

**6** Place absorbent rags beneath the fluid supply and return pipe and hose connections on the pump and be prepared for fluid spillage.

**7** Undo the nut and bolt securing the fluid supply pipe to the support bracket located either at the rear of the pump, or adjacent to the cylinder head cover (see illustrations).

**8** Undo the union nut and disconnect the fluid supply pipe from the top of the pump. Move the pipe to one side and suitably cover the pipe end and the orifice in the pump to prevent dirt ingress.

**9** Slacken the retaining clip, and disconnect the fluid return hose from the pump. If the original crimped type clip is still fitted, cut the clip and discard it; use a standard worm-drive hose clip on refitting. Suitably cover the hose end and the orifice in the pump to prevent dirt ingress.

**10** Undo the rear mounting bolt and the two front mounting bolts and withdraw the pump from the mounting bracket (see illustrations). Access to the front mounting bolts can be gained through the holes in the pump pulley.

**Refitting**

**11** Manoeuvre the pump into position, refit the pump mounting bolts and tighten them to the specified torque.

**12** Reconnect the fluid supply pipe to the pump and securely tighten the union nut. Secure the pipe to the support bracket.



**22.10a** Power steering pump rear mounting bolt (arrowed) ...



**22.7b** ... and on 2.0 litre diesel engines (arrowed)

**13** Refit the return hose to the pump, and securely tighten its retaining clip.

**14** On later diesel engine models, refit the engine cover. On later petrol engine models, refit the heat shield to the rear of the pump.

**15** Refit and tension the auxiliary drivebelt as described in Chapter 1A or 1B as applicable.

**16** On completion, bleed the hydraulic system as described in Section 21.

**23 Track rod balljoint – removal and refitting**

**Note:** A new track rod balljoint-to-swivel hub nut must be used on refitting.

**Removal**

**1** Apply the handbrake, then jack up the front of the vehicle and support it on axle stands (see *Jacking and vehicle support*). Remove the appropriate front roadwheel.

**2** If the balljoint is to be re-used, use a straight-edge and a scribe, or similar, to mark its relationship to the track rod.

**3** Hold the track rod, and unscrew the balljoint locknut by a quarter of a turn (see illustration). Do not move the locknut from this position, as it will serve as a handy reference mark on refitting.

**4** Slacken and remove the nut securing the track rod balljoint to the swivel hub, and release the balljoint tapered shank using a universal balljoint separator. Discard the nut – a new one must be used when refitting.

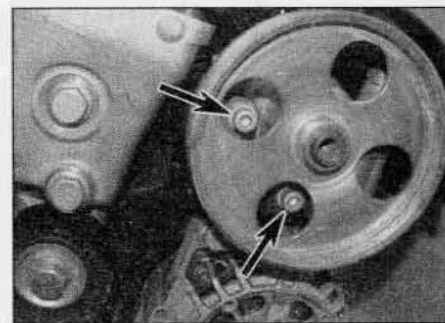

**22.10b** ... and front mounting bolts (arrowed)

**5** Counting the exact number of turns necessary to do so, unscrew the balljoint from the track rod.

**6** Count the number of exposed threads between the end of the balljoint and the locknut, and record this figure. If a new balljoint is to be fitted, unscrew the locknut from the old balljoint.

**7** Carefully clean the balljoint and the threads. Renew the balljoint if its movement is sloppy or too stiff, if excessively worn, or if damaged in any way; carefully check the stud taper and threads. If the balljoint dust cover is damaged, the complete balljoint assembly must be renewed; it is not possible to obtain the dust cover separately.

**Refitting**

**8** If a new balljoint is to be fitted, screw the locknut onto its threads, and position it so that the same number of exposed threads are visible, as was noted prior to removal.

**9** Screw the balljoint into the track rod by the number of turns noted on removal. This should bring the balljoint locknut to within a quarter of a turn from the end face of the track rod, with the alignment marks that were made on removal (if applicable) lined up. Hold the track rod and securely tighten the locknut.

**10** Refit the balljoint shank to the swivel hub, then fit a new retaining nut and tighten it to the specified torque.

**11** Refit the roadwheel, then lower the vehicle to the ground and tighten the roadwheel bolts to the specified torque.

**12** On completion have the front wheel alignment checked, and if necessary, adjusted (see Section 24).

**24 Wheel alignment and steering angles – general information, checking and adjustment**

**Definitions**

**1** A car's steering and suspension geometry is defined in four basic settings – all angles are expressed in degrees (toe settings are also expressed as a measurement); the steering axis is defined as an imaginary line drawn through the axis of the suspension

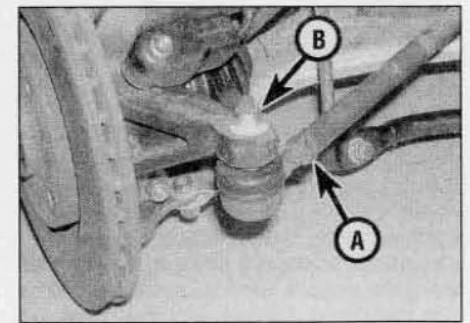

**23.3** Track rod balljoint locknut (A) and balljoint-to-swivel hub retaining nut (B)

strut, extended where necessary to contact the ground.

**2 Camber** is the angle between each roadwheel and a vertical line drawn through its centre and tyre contact patch, when viewed from the front or rear of the car. Positive camber is when the roadwheels are tilted outwards from the vertical at the top; negative camber is when they are tilted inwards. The camber angle is not adjustable.

**3 Castor** is the angle between the steering axis and a vertical line drawn through each roadwheel's centre and tyre contact patch, when viewed from the side of the car. Positive

castor is when the steering axis is tilted so that it contacts the ground ahead of the vertical; negative castor is when it contacts the ground behind the vertical. The castor angle is not adjustable.

**4 Toe** is the difference, viewed from above, between lines drawn through the roadwheel centres and the car's centre-line. 'Toe-in' is when the roadwheels point inwards, towards each other at the front, while 'toe-out' is when they splay outwards from each other at the front.

**5** The front wheel toe setting is adjusted by screwing the track rod in or out of its

balljoints, to alter the effective length of the track rod assembly.

**6** Rear wheel toe setting is not adjustable.

### Checking and adjustment

**7** Due to the special measuring equipment necessary to check the wheel alignment and steering angles, and the skill required to use it properly, the checking and adjustment of these settings is best left to a Peugeot/Citroën dealer or similar expert. Note that most tyre-fitting shops now possess sophisticated checking equipment.

# Chapter 11

## Bodywork and fittings

### Contents

Section number	Section number
Body exterior fittings – removal and refitting . . . . .	23
Bonnet – removal, refitting and adjustment . . . . .	8
Bonnet lock and release cable – removal and refitting . . . . .	9
Central locking components – removal and refitting . . . . .	18
Centre console – removal and refitting . . . . .	29
Door – removal and refitting . . . . .	10
Door inner trim panel – removal and refitting . . . . .	11
Exterior mirrors and mirror glass – removal and refitting . . . . .	19
Facia panel components (post-September 2002 models onward) – removal and refitting . . . . .	31
Facia panel components (pre-September 2002 models) – removal and refitting . . . . .	30
Front bumper – removal and refitting . . . . .	6
Front door handle and lock components – removal and refitting . . . . .	12
Front door window glass and regulator – removal and refitting . . . . .	15
General information . . . . .	1
Hinged rear door handle and lock components – removal and refitting . . . . .	14
Interior trim – removal and refitting . . . . .	28
Maintenance – bodywork and underframe . . . . .	2
Maintenance – upholstery and carpets . . . . .	3
Major body damage – repair . . . . .	5
Minor body damage – repair . . . . .	4
Opening side and door window glass – removal and refitting . . . . .	21
Radiator grille – removal and refitting . . . . .	25
Rear bumper – removal and refitting . . . . .	7
Scuttle grille panel – removal and refitting . . . . .	24
Seat belt components – removal and refitting . . . . .	27
Seats – removal and refitting . . . . .	26
Sliding side door handle and lock components – removal and refitting . . . . .	13
Sunroof – general information . . . . .	22
Tailgate and support struts – removal and refitting . . . . .	16
Tailgate lock components – removal and refitting . . . . .	17
Windscreen, tailgate and rear door window glass – general information . . . . .	20

### Degrees of difficulty

**Easy**, suitable for novice with little experience



**Fairly easy**, suitable for beginner with some experience



**Fairly difficult**, suitable for competent DIY mechanic



**Difficult**, suitable for experienced DIY mechanic



**Very difficult**, suitable for expert DIY or professional



### Specifications

#### Torque wrench setting

	Nm	lbf ft
Seat belt mountings . . . . .	25	18
Sliding side door attachments:		
Lower carriage end stop . . . . .	8	6
Centre carriage bracket . . . . .	20	15

#### 1 General information

The bodyshell is made of pressed-steel sections, and is available in Van or MPV format. Most components are welded together, but some use is made of structural adhesives. The front wings are bolted on.

The bonnet, doors and some other vulnerable panels are made of zinc-coated

metal, and are further protected by being coated with an anti-chip primer prior to being sprayed.

Extensive use is made of plastic materials, mainly in the interior, but also in exterior components. The front and rear bumpers and the front grille are injection-moulded from a synthetic material which is very strong, yet light. Plastic components such as wheel arch liners are fitted to the underside of the vehicle, to improve the body's resistance to corrosion.

#### 2 Maintenance – bodywork and underframe

The general condition of a vehicle's bodywork is the one thing that significantly affects its value. Maintenance is easy, but needs to be regular. Neglect, particularly after minor damage, can lead quickly to further deterioration and costly repair bills. It is important also to keep watch on those parts



of the vehicle not immediately visible, for instance the underside, inside all the wheel arches, and the lower part of the engine compartment.

The basic maintenance routine for the bodywork is washing – preferably with a lot of water, from a hose. This will remove all the loose solids which may have stuck to the vehicle. It is important to flush these off in such a way as to prevent grit from scratching the finish. The wheel arches and underframe need washing in the same way, to remove any accumulated mud which will retain moisture and tend to encourage rust. Paradoxically enough, the best time to clean the underframe and wheel arches is in wet weather, when the mud is thoroughly wet and soft. In very wet weather, the underframe is usually cleaned of large accumulations automatically, and this is a good time for inspection.

Periodically, except on vehicles with a wax-based underbody protective coating, it is a good idea to have the whole of the underframe of the vehicle steam-cleaned, engine compartment included, so that a thorough inspection can be carried out to see what minor repairs and renovations are necessary. Steam-cleaning is available at many garages, and is necessary for the removal of the accumulation of oily grime, which sometimes is allowed to become thick in certain areas. If steam-cleaning facilities are not available, there are one or two excellent grease solvents available, which can be brush-applied; the dirt can then be simply hosed off. Note that these methods should not be used on vehicles with wax-based underbody protective coating, or the coating will be removed. Such vehicles should be inspected annually, preferably just prior to winter, when the underbody should be washed down, and any damage to the wax coating repaired using underseal. Ideally, a completely fresh coat should be applied. It would also be worth considering the use of wax-based protection for injection into door panels, sills, box sections, etc, as an additional safeguard against rust damage, where such protection is not provided by the vehicle manufacturer.

After washing paintwork, wipe off with a chamois leather to give an unspotted clear finish. A coat of clear protective wax polish will give added protection against chemical pollutants in the air. If the paintwork sheen has dulled or oxidised, use a cleaner/polisher combination to restore the brilliance of the shine. This requires a little effort, but such dulling is usually caused because regular washing has been neglected. Care needs to be taken with metallic paintwork, as a special non-abrasive cleaner/polisher is required to avoid damage to the finish. Always check that the door and ventilator opening drain holes and pipes are completely clear, so that water can be drained out. Brightwork should be treated in the same way as paintwork. Windscreens and windows can be kept clear

of the smeary film which often appears, by the use of proprietary glass cleaner. Never use any form of wax or other body or chromium polish on glass.

### 3 Maintenance – upholstery and carpets

Mats and carpets should be brushed or vacuum-cleaned regularly, to keep them free of grit. If they are badly stained, remove them from the vehicle for scrubbing or sponging, and make quite sure they are dry before refitting. Seats and interior trim panels can be kept clean by wiping with a damp cloth and a proprietary upholstery cleaner. If they do become stained (which can be more apparent on light-coloured upholstery), use a little liquid detergent and a soft nail brush to scour the grime out of the grain of the material. Do not forget to keep the headlining clean in the same way as the upholstery. When using liquid cleaners inside the vehicle, do not over-wet the surfaces being cleaned. Excessive damp could get into the seams and padded interior, causing stains, offensive odours or even rot. If the inside of the vehicle gets wet accidentally, it is worthwhile taking some trouble to dry it out properly, particularly where carpets are involved.

**Caution: Do not leave oil or electric heaters inside the vehicle for this purpose.**

### 4 Minor body damage – repair

#### Scratches

If the scratch is very superficial, and does not penetrate to the metal of the bodywork, repair is very simple. Lightly rub the area of the scratch with a paintwork renovator, or a very fine cutting paste, to remove loose paint from the scratch, and to clear the surrounding bodywork of wax polish. Rinse the area with clean water.

Apply touch-up paint to the scratch using a fine paint brush; continue to apply fine layers of paint until the surface of the paint in the scratch is level with the surrounding paintwork. Allow the new paint at least two weeks to harden, then blend it into the surrounding paintwork by rubbing the scratch area with a paintwork renovator or a very fine cutting paste. Finally apply wax polish.

Where the scratch has penetrated right through to the metal of the bodywork, causing the metal to rust, a different repair technique is required. Remove any loose rust from the bottom of the scratch with a penknife, then apply rust-inhibiting paint, to prevent the formation of rust in the future. Using a rubber or nylon applicator, fill the scratch with bodystopper paste. If required, this paste can

be mixed with cellulose thinners, to provide a very thin paste which is ideal for filling narrow scratches. Before the stopper-paste in the scratch hardens, wrap a piece of smooth cotton rag around the top of a finger. Dip the finger in cellulose thinners, and quickly sweep it across the surface of the stopper-paste in the scratch; this will ensure that the surface of the stopper-paste is slightly hollowed. The scratch can now be painted over as described earlier in this Section.

#### Dents

When deep denting of the vehicle's bodywork has taken place, the first task is to pull the dent out, until the affected bodywork almost attains its original shape. There is little point in trying to restore the original shape completely, as the metal in the damaged area will have stretched on impact, and cannot be reshaped fully to its original contour. It is better to bring the level of the dent up to a point which is about 3 mm below the level of the surrounding bodywork. In cases where the dent is very shallow anyway, it is not worth trying to pull it out at all. If the underside of the dent is accessible, it can be hammered out gently from behind, using a mallet with a wooden or plastic head. Whilst doing this, hold a suitable block of wood firmly against the outside of the panel, to absorb the impact from the hammer blows and thus prevent a large area of the bodywork from being 'belled-out'.

Should the dent be in a section of the bodywork which has a double skin, or some other factor making it inaccessible from behind, a different technique is called for. Drill several small holes through the metal inside the area – particularly in the deeper section. Then screw long self-tapping screws into the holes, just sufficiently for them to gain a good purchase in the metal. Now the dent can be pulled out by pulling on the protruding heads of the screws with a pair of pliers.

The next stage of the repair is the removal of the paint from the damaged area, and from an inch or so of the surrounding 'sound' bodywork. This is accomplished most easily by using a wire brush or abrasive pad on a power drill, although it can be done just as effectively by hand, using sheets of abrasive paper. To complete the preparation for filling, score the surface of the bare metal with a screwdriver or the tang of a file, or alternatively, drill small holes in the affected area. This will provide a really good 'key' for the filler paste.

To complete the repair, see the Section on filling and respraying.

#### Rust holes or gashes

Remove all paint from the affected area, and from an inch or so of the surrounding 'sound' bodywork, using an abrasive pad or a wire brush on a power drill. If these are not available, a few sheets of abrasive paper will do the job most effectively. With the paint removed, you will be able to judge the severity

of the corrosion, and therefore decide whether to renew the whole panel (if this is possible) or to repair the affected area. New body panels are not as expensive as most people think, and it is often quicker and more satisfactory to fit a new panel than to attempt to repair large areas of corrosion.

Remove all fittings from the affected area, except those which will act as a guide to the original shape of the damaged bodywork (eg headlight shells etc). Then, using tin snips or a hacksaw blade, remove all loose metal and any other metal badly affected by corrosion. Hammer the edges of the hole inwards, in order to create a slight depression for the filler paste.

Wire-brush the affected area to remove the powdery rust from the surface of the remaining metal. Paint the affected area with rust-inhibiting paint; if the back of the rusted area is accessible, treat this also.

Before filling can take place, it will be necessary to block the hole in some way. This can be achieved by the use of aluminium or plastic mesh, or aluminium tape.

Aluminium or plastic mesh, or glass-fibre matting, is probably the best material to use for a large hole. Cut a piece to the approximate size and shape of the hole to be filled, then position it in the hole so that its edges are below the level of the surrounding bodywork. It can be retained in position by several blobs of filler paste around its periphery.

Aluminium tape should be used for small or very narrow holes. Pull a piece off the roll, trim it to the approximate size and shape required, then pull off the backing paper (if used) and stick the tape over the hole; it can be overlapped if the thickness of one piece is insufficient. Burnish down the edges of the tape with the handle of a screwdriver or similar, to ensure that the tape is securely attached to the metal underneath.

### Filling and respraying

Before using this Section, see the Sections on dent, minor scratch, rust holes and gash repairs.

Many types of bodyfiller are available, but generally speaking, those proprietary kits which contain a tin of filler paste and a tube of resin hardener are best for this type of repair; some can be used directly from the tube. A wide, flexible plastic or nylon applicator will be found invaluable for imparting a smooth and well-contoured finish to the surface of the filler.

Mix up a little filler on a clean piece of card or board – measure the hardener carefully (follow the maker's instructions on the pack), otherwise the filler will set too rapidly or too slowly. Using the applicator, apply the filler paste to the prepared area; draw the applicator across the surface of the filler to achieve the correct contour and to level the surface. As soon as a contour that approximates to the correct one is achieved, stop working the paste – if you carry on too

long, the paste will become sticky and begin to 'pick-up' on the applicator. Continue to add thin layers of filler paste at 20-minute intervals, until the level of the filler is just proud of the surrounding bodywork.

Once the filler has hardened, the excess can be removed using a metal plane or file. From then on, progressively-finer grades of abrasive paper should be used, starting with a 40-grade production paper, and finishing with a 400-grade wet-and-dry paper. Always wrap the abrasive paper around a flat rubber, cork, or wooden block – otherwise the surface of the filler will not be completely flat. During the smoothing of the filler surface, the wet-and-dry paper should be periodically rinsed in water. This will ensure that a very smooth finish is imparted to the filler at the final stage.

At this stage, the 'dent' should be surrounded by a ring of bare metal, which in turn should be encircled by the finely 'feathered' edge of the good paintwork. Rinse the repair area with clean water, until all of the dust produced by the rubbing-down operation has gone.

Spray the whole area with a light coat of primer – this will show up any imperfections in the surface of the filler. Repair these imperfections with fresh filler paste or bodystopper, and once more smooth the surface with abrasive paper. If bodystopper is used, it can be mixed with cellulose thinners, to form a really thin paste which is ideal for filling small holes. Repeat this spray-and-repair procedure until you are satisfied that the surface of the filler, and the feathered edge of the paintwork, are perfect. Clean the repair area with clean water, and allow to dry fully.

The repair area is now ready for final spraying. Paint spraying must be carried out in a warm, dry, windless and dust-free atmosphere. This condition can be created artificially if you have access to a large indoor working area, but if you are forced to work in the open, you will have to pick your day very carefully. If you are working indoors, dousing the floor in the work area with water will help to settle the dust which would otherwise be in the atmosphere. If the repair area is confined to one body panel, mask off the surrounding panels; this will help to minimise the effects of a slight mismatch in paint colours. Bodywork fittings (eg chrome strips, door handles etc) will also need to be masked off. Use genuine masking tape, and several thicknesses of newspaper, for the masking operations.

Before commencing to spray, agitate the aerosol can thoroughly, then spray a test area (an old tin, or similar) until the technique is mastered. Cover the repair area with a thick coat of primer; the thickness should be built up using several thin layers of paint, rather than one thick one. Using 400 grade wet-and-dry paper, rub down the surface of the primer until it is really smooth. While doing this, the work area should be thoroughly doused with water, and the wet-and-dry paper periodically rinsed in water. Allow to dry before spraying on more paint.

Spray on the top coat, again building up the

thickness by using several thin layers of paint. Start spraying at the top of the repair area, and then, using a side-to-side motion, work downwards until the whole repair area and about 2 inches of the surrounding original paintwork is covered. Remove all masking material 10 to 15 minutes after spraying on the final coat of paint.

Allow the new paint at least two weeks to harden, then, using a paintwork renovator or a very fine cutting paste, blend the edges of the paint into the existing paintwork. Finally, apply wax polish.

### Plastic components

With the use of more and more plastic body components by the vehicle manufacturers (eg bumpers, spoilers, and in some cases major body panels), rectification of more serious damage to such items has become a matter of either entrusting repair work to a specialist in this field, or renewing complete components. Repair of such damage by the DIY owner is not really feasible, owing to the cost of the equipment and materials required for effecting such repairs. The basic technique involves making a groove along the line of the crack in the plastic, using a rotary burr in a power drill. The damaged part is then welded back together, using a hot air gun to heat up and fuse a plastic filler rod into the groove. Any excess plastic is then removed, and the area rubbed down to a smooth finish. It is important that a filler rod of the correct plastic is used, as body components can be made of a variety of different types (eg polycarbonate, ABS, polypropylene).

Damage of a less serious nature (abrasions, minor cracks etc) can be repaired by the DIY owner using a two-part epoxy filler repair material. Once mixed in equal proportions, this is used in similar fashion to the bodywork filler used on metal panels. The filler is usually cured in twenty to thirty minutes, ready for sanding and painting.

If the owner is renewing a complete component himself, or if he has repaired it with epoxy filler, he will be left with the problem of finding a suitable paint for finishing which is compatible with the type of plastic used. At one time, the use of a universal paint was not possible, owing to the complex range of plastics encountered in body component applications. Standard paints, generally speaking, will not bond to plastic or rubber satisfactorily. However, it is now possible to obtain a plastic body parts finishing kit which consists of a pre-primer treatment, a primer and coloured top coat. Full instructions are normally supplied with a kit, but basically, the method of use is to first apply the pre-primer to the component concerned, and allow it to dry for up to 30 minutes. Then the primer is applied, and left to dry for about an hour before finally applying the special-coloured top coat. The result is a correctly-coloured component, where the paint will flex with the plastic or rubber, a property that standard paint does not normally possess.



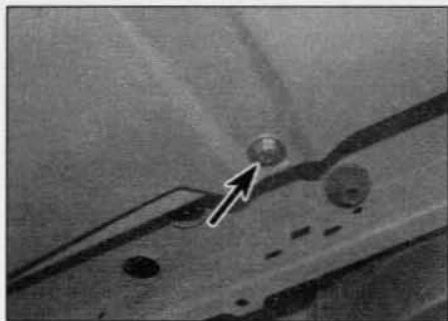

6.4 Undo the bolts (arrowed) securing the lower front part of the bumper to the radiator support platform – early models

**5 Major body damage – repair**

Where serious damage has occurred, or large areas need renewal due to neglect, it means that complete new panels will need welding-in, and this is best left to professionals. If the damage is due to impact, it will also be necessary to check completely the alignment of the bodyshell, and this can only be carried out accurately by a Peugeot/Citroën dealer, or accident repair specialist, using special jigs. If the body is left misaligned, it is primarily dangerous, as the car will not handle properly, and secondly, uneven stresses will be imposed on the steering,

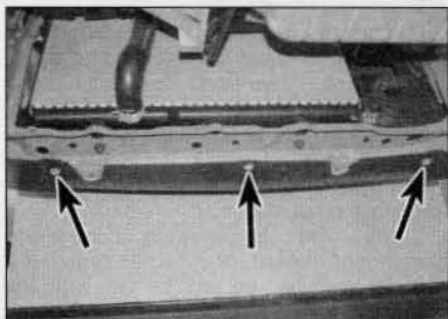

6.10 Undo the bolts (arrowed) securing the bumper to the radiator support platform – later models



6.11 Undo the bolts (arrowed) securing the upper front edge of the bumper to the bumper bracket – later models

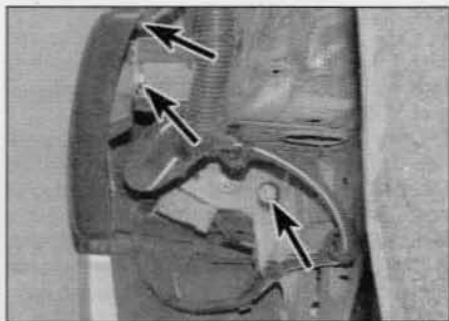

6.5 Front bumper attachments under the wheel arch (arrowed) – early models

suspension and possibly transmission, causing abnormal wear, or complete failure, particularly to such items as the tyres.

**6 Front bumper – removal and refitting**

**Note:** The help of an assistant is useful to support the bumper during the removal and refitting procedure.

**Pre-September 2002 models**

**Removal**

- 1 Firmly apply the handbrake, then jack up the front of the vehicle and support it securely on axle stands (see *Jacking and vehicle support*). To improve access to the bumper fasteners, remove both front roadwheels.
- 2 Remove the radiator grille as described in Section 25.
- 3 Release the front section of the wheel arch liner on each side as described in Section 23.
- 4 Undo the two bolts securing the lower front part of the bumper to the radiator support platform (see illustration).
- 5 Working under the wheel arch on each side, undo the bolt securing the rear edge of the bumper to the front wing (see illustration). Similarly, undo the two bolts securing the bumper to the mounting bracket and inner wing panel.
- 6 With the help of an assistant, carefully pull the bumper forward and off the car (see illustration).

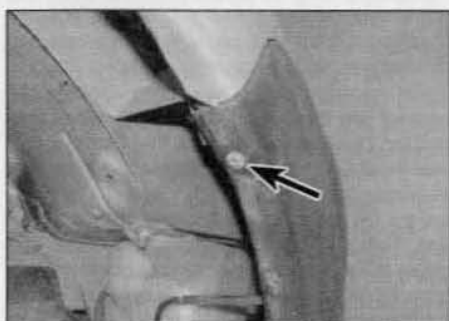

6.13 Undo the bolt (arrowed) securing the rear edge of the bumper to the front wing – later models



6.6 Carefully pull the bumper forward and off the car – early models

**Refitting**

7 Refitting is a reversal of removal.

**Post-September 2002 models**

**Removal**

- 8 Firmly apply the handbrake, then jack up the front of the vehicle and support it securely on axle stands (see *Jacking and vehicle support*). To improve access to the bumper fasteners, remove both front roadwheels.
- 9 Remove the radiator grille as described in Section 25.
- 10 Undo the three bolts securing the lower front part of the bumper to the radiator support platform (see illustration).
- 11 Undo the three bolts securing the upper front edge of the bumper to the bumper bracket (see illustration).
- 12 Release the front section of the wheel arch liner on each side as described in Section 23.
- 13 Undo the bolt securing the rear edge of the bumper to the front wing each side (see illustration).
- 14 On models equipped with foglights, disconnect the foglight wiring connectors, and release the wiring from the bumper clips.
- 15 Working on one side at a time, reach up under the wheel arch and release the catch securing the upper rear section of the bumper to the front wing. To do this, insert a screwdriver through the square hole in the wing and depress the catch while at the same time pulling the rear of the bumper outward (see illustration).

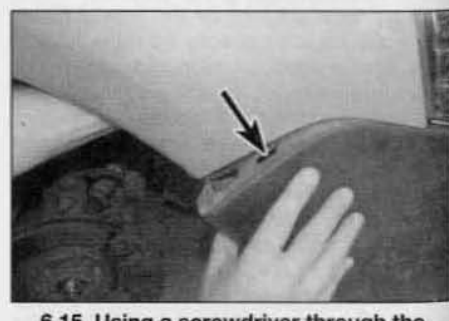

6.15 Using a screwdriver through the square hole (arrowed), depress the internal catch in the wing to release the bumper – later models



16 With the catch released, pull the bumper outward and sharply forward to release the remaining retaining clip (see illustration).

17 Release the other side of the bumper in the same way then, with the help of an assistant, carefully pull the bumper forward and off the car.

18 To remove the bumper bracket, undo the two bolts each side and lift the bracket from its location.

**Refitting**

19 Refitting is a reversal of removal, ensuring that the catches each side correctly engage with the front wings as it is located in position.

**7 Rear bumper – removal and refitting**



**Note:** The help of an assistant is useful to support the bumper during the removal and refitting procedure.

**Removal**

1 Chock the front wheels, then jack up the rear of the vehicle and support securely on axle stands (see *Jacking and vehicle support*).

2 Undo the screw securing the wheel arch liner to the lower corner of the bumper on each side (see illustration).

3 Remove the rear light unit on both sides as described in Chapter 12.

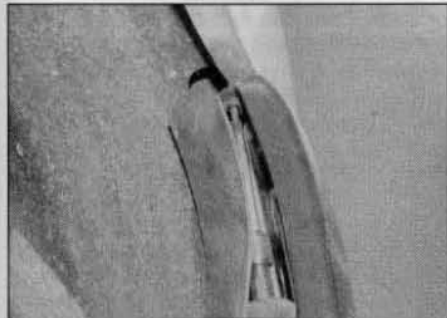

7.4 Undo the screw securing the upper front corner of the bumper to the rear wing



7.7 Undo the screws securing the upper edge of the bumper to the bumper bracket

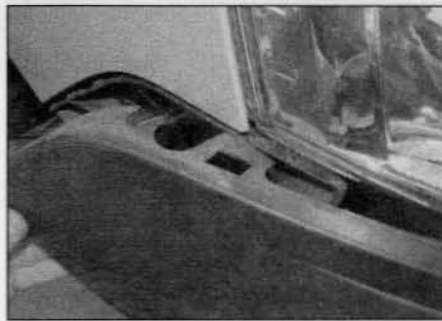

6.16 Pull the bumper outwards and sharply forward to release the remaining retaining clip – later models

4 Ease the wheel arch liner away from the bumper and undo the screw securing the upper front corner of the bumper to the rear wing on each side (see illustration).

5 Similarly, from behind the wheel arch liner, undo the bolt securing the side of the bumper to the rear wing (see illustration).

6 Undo the bumper securing screw each side at the base of the rear light unit location (see illustration).

7 Undo the five screws securing the upper edge of the bumper to the bumper bracket (see illustration).

8 Release the two retaining tabs on the lower edge of the bumper from the support brackets (see illustration).

9 With the help of an assistant, carefully pull the bumper rearwards and off the car.

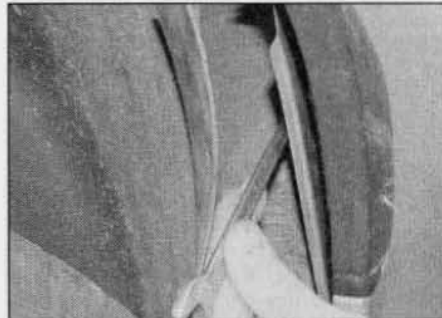

7.5 Undo the bolt securing the side of the bumper to the rear wing

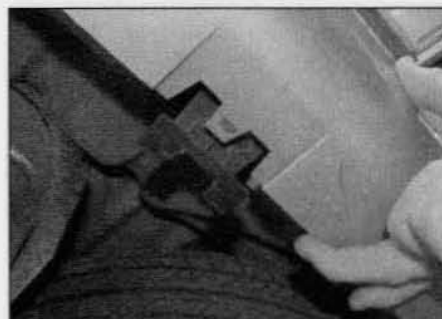

7.8 Release the retaining tabs on the lower edge of the bumper from the support brackets

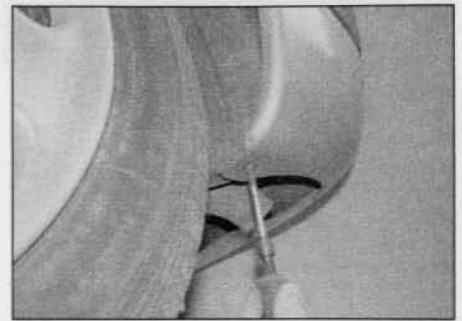

7.2 Undo the screw securing the wheel arch liner to the lower corner of the rear bumper

10 To remove the bumper bracket, undo the four bolts and lift the bracket from its location.

**Refitting**

11 Refitting is a reversal of removal, ensuring that the pegs each side correctly engage with the rear wings as it is located in position (see illustration).

**8 Bonnet – removal, refitting and adjustment**

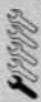

**Removal**

1 Open the bonnet and have an assistant support it then, using a pencil or felt tip pen,

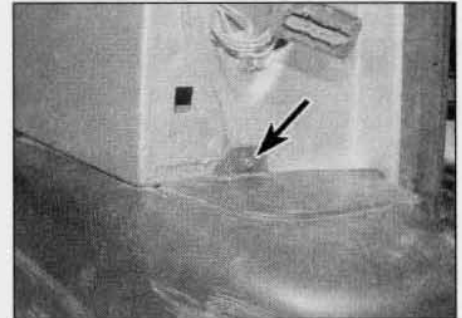

7.6 Undo the securing screw (arrowed) each side, at the base of the rear light unit location



7.11 Ensure that the pegs each side correctly engage with the rear wings as the bumper is located in position

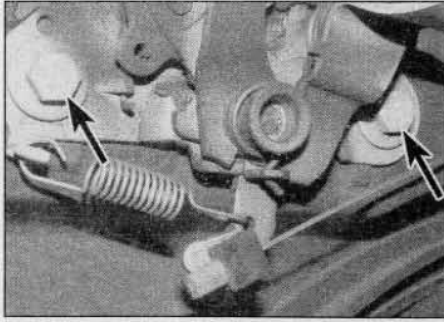

9.2 Bonnet lock retaining bolts (arrowed)

mark the outline of each bonnet hinge relative to the bonnet, to use as a guide on refitting.  
**2** Disconnect the washer jet supply tubing from the right-hand jet and release the supply tubing from the retaining clips.  
**3** Unscrew the bonnet-to-hinge retaining bolts each side. With the help of the assistant, carefully lift the bonnet from the vehicle. Store the bonnet out of the way in a safe place.  
**4** Inspect the bonnet hinges for signs of wear and free play at the pivots, and if necessary renew. Each hinge is secured to the body by two bolts. On refitting, apply a smear of multi-purpose grease to the hinges.

### Refitting and adjustment

**5** With the aid of an assistant, offer up the bonnet, and engage the retaining bolts. Align the hinges with the marks made on removal, then tighten the retaining bolts securely. Reconnect the washer jet tubing.  
**6** Close the bonnet, and check for alignment with the adjacent panels. If necessary, slacken the hinge bolts and re-align the bonnet to suit. When correctly aligned, tighten the hinge bolts securely.  
**7** Once the bonnet is correctly aligned, check that the bonnet fastens and releases in a satisfactory manner. If adjustment is necessary, slacken the bonnet lock retaining bolts, and adjust the position of the lock to suit. Once the lock is operating correctly, securely tighten its retaining bolts.

### 9 Bonnet lock and release cable – removal and refitting



#### Removal

**1** Remove the radiator grille as described in Section 25.  
**2** Undo the two bolts securing the bonnet lock to the radiator support frame (see illustration). Withdraw the lock and disconnect the release cable.  
**3** Work along the length of the cable in the engine compartment, note their fitted locations, and release the cable retaining clips.  
**4** Use a screwdriver to push the cable

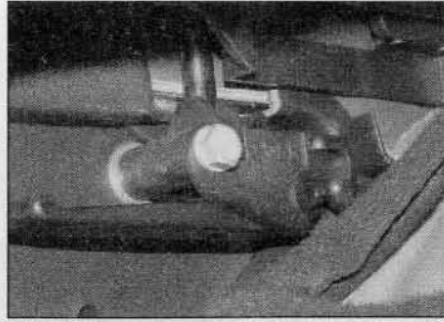

9.5 Undo the bolt securing the bonnet release lever

bulkhead grommet into the passenger compartment.

**5** Working under the fascia on the right- or left-hand side (according to model), unscrew the release lever retaining bolt, and withdraw the lever assembly from its location (see illustration).

**6** Tie a length of string to the end of the cable in the engine compartment, note its routing, then carefully pull the cable through into the passenger compartment. Untie the string from the end of the cable, and leave it in position to aid refitting.

#### Refitting

**7** Locate the cable in position in the passenger compartment.

**8** Tie the end of the new cable to the string, and pull it through into the engine compartment.

**9** Check that the bulkhead grommet is securely seated, then remove the string and connect the cable to the bonnet lock lever.

**10** Secure the release lever in place, tightening its retaining bolt securely.

**11** Reconnect the cable to the bonnet lock then refit the lock, tightening its retaining bolts securely.

**12** Secure the cable in place with its retaining clips. Check the operation of the lock and, if necessary, adjust the position of the lock within the elongated bolt holes to achieve satisfactory operation prior to closing the bonnet.

**13** Refit the radiator grille as described in Section 25 on completion.

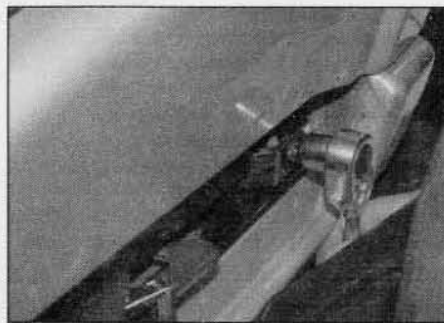

10.9a Undo the retaining bolt ...

### 10 Door – removal and refitting



#### Front door

##### Removal

**1** Disconnect the battery negative terminal (refer to *Disconnecting the battery* in the Reference Chapter).

**2** Open the door then release the locking ring and disconnect the door wiring connector from the door socket.

**3** Unscrew the two securing bolts, and disconnect the door check strap from the door pillar.

**4** Ensure that the door is adequately supported, then unscrew the upper and lower hinge pins. Carefully lift the door from the vehicle.

##### Refitting

**5** Refitting is a reversal of removal, but on completion check the fit of the door in relation to the surrounding body panels. If adjustment is necessary, the door position can be altered by means of the elongated slots in the hinge plates attached to the door.

#### Sliding side door

##### Removal

**6** Remove the side door upper trim panel as described in Section 28.

**7** Open the side door and position suitably protected axle stands below the door. Pack the stands so they are just taking the weight of the door.

**8** Remove the end piece from the rear of the door upper guide rail. Undo the retaining screw and remove the end stop plate from the upper guide rail. Note that the end piece and end stop plate are not fitted to all models.

**9** Undo the retaining bolt and remove the lower carriage end stop, from the rear end of the lower guide rail (see illustrations).

**10** Undo the two bolts securing the centre carriage bracket to the rear of the door.

**11** With the help of an assistant, disengage the upper and lower carriages from the guide



10.9b ... and remove the side door lower carriage end stop from the rear end of the lower guide rail



**10.20** Release the tailgate wiring harness grommet, then withdraw the harness from the door

rails and carefully remove the door from the vehicle.

**Refitting**

**12** Refitting is a reversal of removal, tightening the retaining bolts to the specified torque.

**Hinged rear door**

**Note:** The following procedure is based on the equipment fitted to high-specification models. Some of the components listed may not be fitted to lower specification models.

**Removal**

**13** Disconnect the battery negative terminal (refer to *Disconnecting the battery* in the Reference Chapter).

**14** Remove the rear door inner trim panel as described in Section 28.

**15** Disengage the door check strap from the bracket on the body.

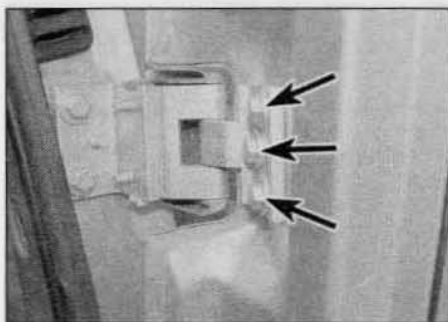

**10.21a** Undo the three upper bolts (arrowed) ...

**16** Disconnect the washer hose from the rear window wiper motor, and release the hose from its retaining clips.

**17** Disconnect the wiring connectors from the following components with reference to the relevant Sections of this Chapter, and Chapter 12:

- a) Rear window wiper motor.
- b) Door lock motor.
- c) Rear window demister elements.
- d) High-level stop-light.
- e) Number plate lights.

**18** Release the wiring harness retaining clips from the door panel.

**19** Check that all wiring connectors have been disconnected, then tie a length of string to the high-level stop-light wiring connector. The string can be used to draw the wiring back up through the door when the harness is refitted.

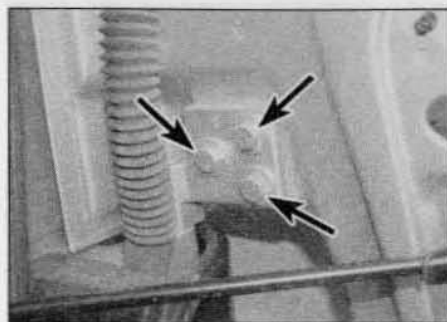

**10.21b** ... and three lower bolts (arrowed) securing the hinges to the rear door

**20** Release the wiring harness grommet, then withdraw the harness from the door (see illustration). When the string appears, untie it from the wiring connector and leave it in position in the door.

**21** With the help of an assistant to support the door, undo the three upper bolts and three lower bolts securing the hinges to the door (see illustrations). Carefully lift the door from the vehicle.

**Refitting**

**22** Refitting is a reversal of removal, ensuring all wiring connectors are securely reconnected.

**11 Door inner trim panel - removal and refitting**



**11.1** On models with manual windows, pull the winder handle off the spindle



**11.2a** Carefully prise off the base of the door pull handle trim ...



**11.2b** ... lift the handle trim off the upper locating lug and remove it from the handle



**11.4a** Carefully prise up the interior door handle surround ...



**11.4b** ... and disengage it from the handle

**Front door**

**Removal**

**1** On models with manual windows, pull the winder handle off the spindle (see illustration).

**2** Using a small screwdriver, carefully prise off the base of the door pull handle trim. Lift the handle trim off the upper locating lug and remove it from the handle (see illustrations).

**3** Undo the two retaining screws in the centre of the door pull handle.

**4** Carefully prise up the interior door handle surround and disengage it from the handle (see illustrations).



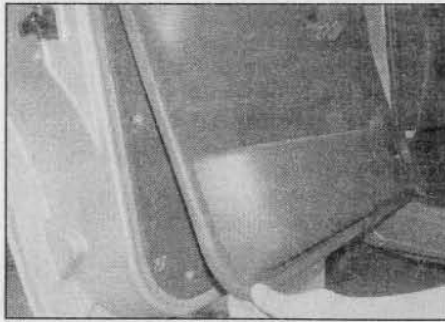

11.7 Pull the trim panel outwards, lift it up and remove it from the door

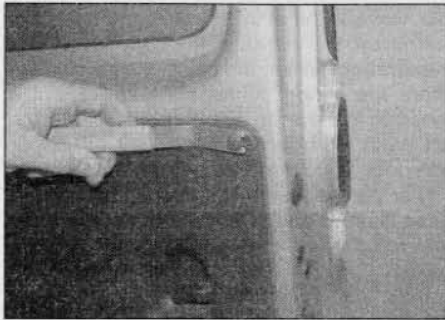

11.14 Work around the edge of the rear door trim panel and release the stud fasteners

5 Remove the loudspeaker from the door as described in Chapter 12.

6 Using a suitable forked tool, work around the edge of the trim panel, and release the securing clips.

7 Pull the panel outwards, lift it up and remove it from the door (see illustration).

**Refitting**

8 Before refitting, check whether any of the trim panel retaining studs were broken on removal. Renew the panel retaining studs as necessary, then refit the panel using a reversal of removal.

**Sliding side door**

**Removal**

9 Remove the sliding side door as described in Section 10.

10 Undo the two screws securing the top of the panel to the door (see illustration).

11 Using a suitable forked tool, work around the edge of the trim panel, and release the stud fasteners (see illustration).

12 Remove the panel from the door.

**Refitting**

13 Refitting is a reversal of removal.

**Hinged rear door**

**Removal**

14 Using a suitable forked tool, work around the edge of the trim panel, and release the stud fasteners (see illustration).

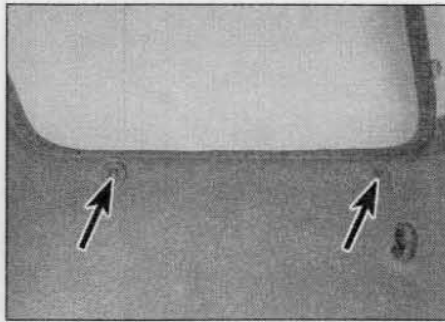

11.10 Undo the screws (arrowed) securing the top of the trim panel to the sliding side door

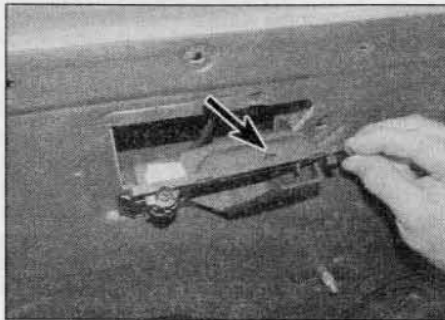

12.2 Slide the front door interior handle assembly towards the front of the door to disengage the locating lug (arrowed)

15 Remove the panel from the door.

**Refitting**

16 Refitting is a reversal of removal.

**12 Front door handle and lock components – removal and refitting**

**Interior door handle**

**Removal**

1 Remove the door inner trim panel, as described in Section 11.

2 Slide the handle assembly towards the front of the door to disengage the locating lug,

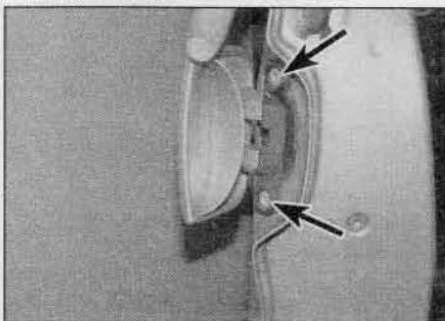

12.4 Drill off the rivet heads (arrowed) and withdraw the front door exterior handle from the door

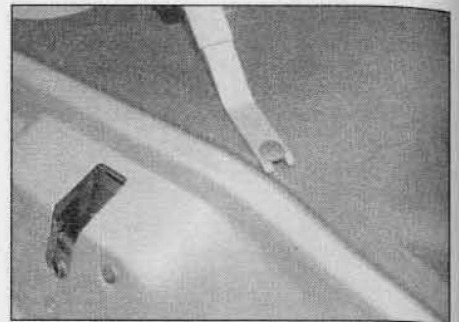

11.11 Work around the edge of the sliding side door trim panel, and release the stud fasteners

ease it away from the door and disconnect the link rod (see illustration).

**Refitting**

3 Refitting is a reversal of removal. Refit the inner trim panel as described in Section 11.

**Exterior door handle**

**Note:** The exterior handle is riveted to the door. Ensure that new rivets of the correct size are available for refitting.

**Removal**

4 Using a 6.0 mm drill, drill off the rivet heads from the outside and withdraw the handle from the door (see illustration). Disconnect the link rod and remove the handle.

**Refitting**

5 Refitting is a reversal of removal, using new pop rivets to secure the handle.

**Lock cylinder**

**Note:** A new door sealing sheet may be required on refitting.

**Removal**

6 Remove the door inner trim panel, as described in Section 11.

7 Using a sharp knife, carefully release the plastic sealing sheet from the adhesive bead and remove the sheet from the door. If care is taken, it may just be possible to remove the sheet in one piece and re-use it when refitting (see illustration).

8 Working inside the door, disconnect the lock cylinder link rod from the door lock.



12.7 Using a sharp knife, carefully release the plastic sealing sheet from the adhesive bead

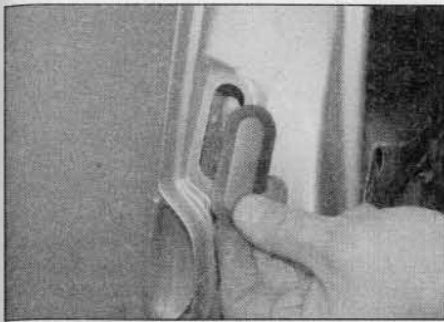

**12.9** Carefully prise out the plastic aperture cover from the rear edge of the door

9 Using a screwdriver, carefully prise out the plastic aperture cover from the rear edge of the door (see illustration). Note that the cover is made of extremely brittle plastic and is likely to be damaged during removal.

10 Working through the aperture in the edge of the door, extract the large horseshoe-shaped retaining clip from the rear of the lock cylinder. The retaining clip has a hole in its side to allow a threaded removal tool to be screwed into it. A suitable tool can be made from a length of rod with a self-tapping screw brazed to one end (see illustrations).

11 With the retaining clip removed, withdraw the lock cylinder from outside the door (see illustration).

**Refitting**

12 Refitting is a reversal of removal, but ensure that the lock cylinder retaining clip is securely refitted. Fit a new sealing sheet to the door if the original was damaged in any way during removal. On completion, refit the door inner trim panel as described in Section 11.

**Door lock**

**Note:** A new door sealing sheet may be required on refitting.

**Removal**

13 Remove the door inner trim panel, as described in Section 11.

14 Using a sharp knife, carefully release the plastic sealing sheet from the adhesive bead and remove the sheet from the door. If care is taken, it may just be possible to remove the sheet in one piece and re-use it when refitting (see illustration 12.7).

15 Working inside the door, disconnect the link rods from the door lock.

16 Disconnect the wiring connector from the door lock motor.

17 Undo the three screws securing the lock assembly to the edge of the door.

18 Undo the bellcrank retaining screw located above the three door lock screws.

19 Remove the door lock assembly, complete with bellcrank out through the door aperture (see illustration).

**Refitting**

20 Refitting is a reversal of removal. Fit a new sealing sheet to the door if the original was



**12.10a** The lock cylinder retaining clip has a hole (arrowed) in its side to allow a threaded removal tool to be screwed into it



**12.10b** Using a suitable removable tool, extract the retaining clip from the lock cylinder

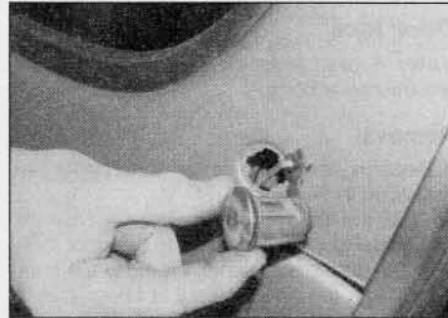

**12.11** Withdraw the lock cylinder from outside the door

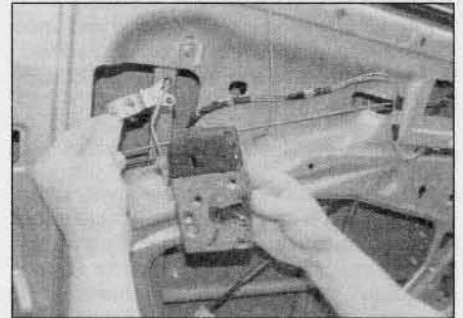

**12.19** Remove the door lock assembly, complete with bellcrank out through the door aperture

damaged in any way during removal. On completion, refit the door inner trim panel as described in Section 11.

**13 Sliding side door handle and lock components – removal and refitting**

**Note:** The sliding side door must be removed from the vehicle for all the following operations (see Section 10).

**Interior door handle**

**Removal**

1 Remove the door inner trim panel, as described in Section 11.

2 Undo the upper and lower interior door handle retaining screws, noting that the upper



**13.2a** Undo the upper (arrowed) . . .

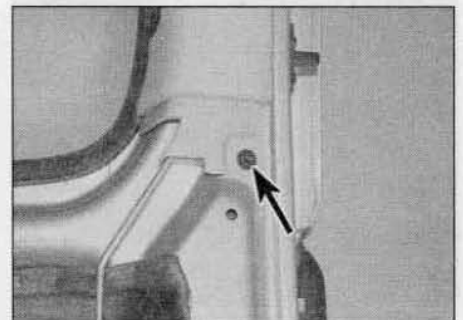

**13.2b** . . . and lower (arrowed) interior door handle retaining screws

screw is located under a trim cap (see illustrations).

3 Disconnect the operating link rod from the bellcrank and remove the interior handle from the door.

**Refitting**

4 Refitting is a reversal of removal. On completion, refit the door inner trim panel as described in Section 11.

**Exterior door handle**

**Removal**

5 Remove the door inner trim panel, as described in Section 11.

6 Disconnect the two exterior door handle link rods from their respective levers on the lock control unit, noting their fitted positions (see illustration).



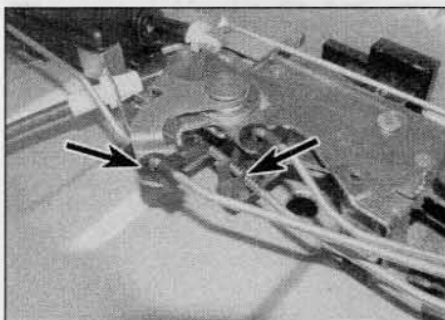

13.6 Disconnect the exterior door handle link rods (arrowed) from their respective levers on the lock control unit

7 Peel back the foam sealing panel and undo the two exterior door handle retaining screws. Remove the handle and link rods from outside the door (see illustrations).

**Refitting**

8 Refitting is a reversal of removal. When connecting the link rod with the adjustable threaded end, engage it in the clips on the lock control unit lever and check for correct operation of the lock mechanism. If necessary, reposition the link rod in the lock control unit lever to achieve satisfactory operation. On completion, relocate the foam sealing panel in position and refit the door inner trim panel as described in Section 11.

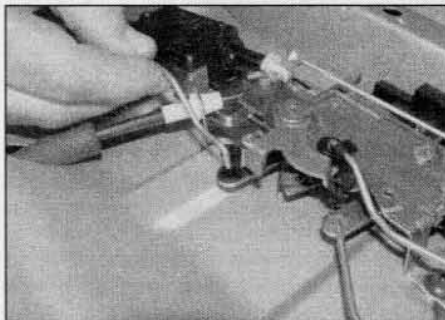

13.11 Disconnect the door lock link rod from the lever on the lock control unit

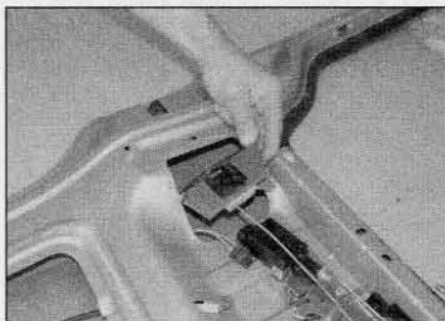

13.12b ... and withdraw the lock and link rod from the door

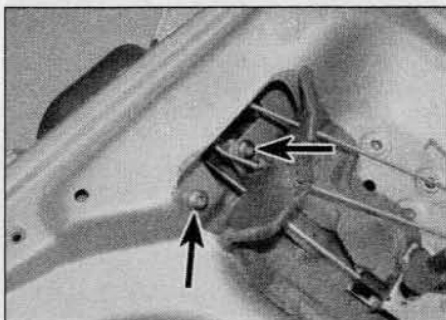

13.7a Peel back the foam sealing panel and undo the two exterior door handle retaining screws (arrowed) ...

**Door lock**

**Note:** A new foam sealing panel may be required on refitting.

**Removal**

9 Remove the door inner trim panel, as described in Section 11.

10 Using a sharp knife, carefully release the foam sealing panel adjacent to the door lock, from the adhesive bead and remove the foam panel from the door. If care is taken, it may just be possible to remove the panel in one piece and re-use it when refitting.

11 Disconnect the door lock link rod from the lever on the lock control unit, noting its fitted position (see illustration).

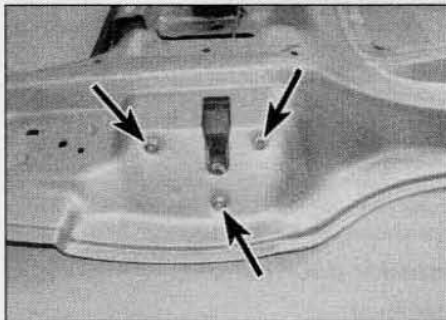

13.12a Undo the three retaining screws (arrowed) ...

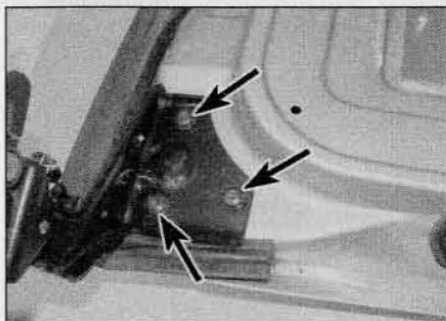

13.14 Undo the three screws (arrowed) and withdraw the door open holding latch from the door

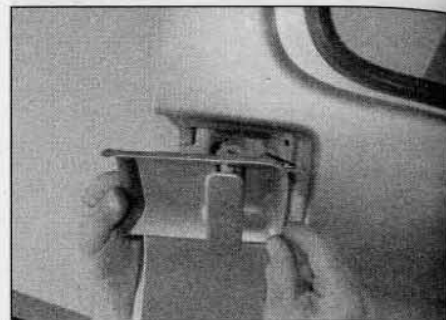

13.7b ... then remove the handle and link rods from outside the door

12 Undo the three retaining screws and withdraw the lock and link rod from the door (see illustrations).

**Refitting**

13 Refitting is a reversal of removal. Fit a new foam sealing panel to the door if the original was damaged in any way during removal. On completion, refit the door inner trim panel as described in Section 11.

**Door open holding latch**

**Removal**

14 Undo the three retaining screws and withdraw the latch from the door (see illustration).

15 Slacken the screw securing the operating cable clamp plate to the door and slide the cable out of the clamp. Disconnect the cable end from the operating lever and remove the latch from the door (see illustration).

**Refitting**

16 Refitting is a reversal of removal, but adjust the operating cable as follows before tightening the operating cable clamp plate screw.

17 Align the adjustment holes in the latch locking lever and mounting bracket and insert a 5.0 mm drill bit through the two holes (see illustration 13.15).

18 Pull the operating cable to take up any slack, then tighten the clamp plate retaining

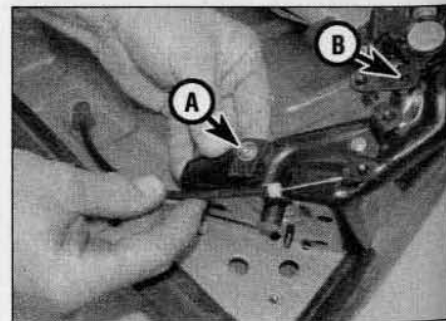

13.15 Slacken the clamp screw (A) and slide the cable out of the clamp. Note the adjustment hole (B) in the latch locking lever





**13.20** Release the plastic sealing sheet from the adhesive bead and remove the sheet from the door

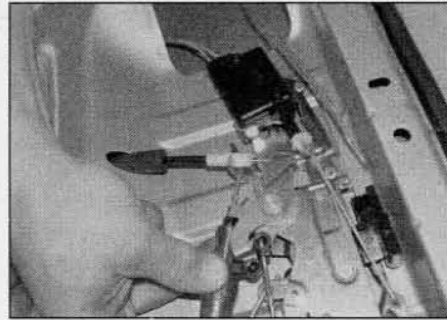

**13.21a** Release the outer cable sheath from the mounting bracket . . .

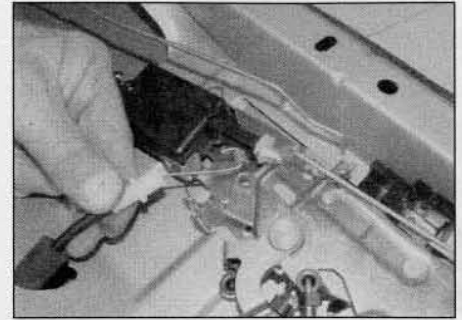

**13.21b** . . . then disconnect the inner cable end fitting from the operating lever

screw. Remove the drill bit and check for correct operation of the latch.

**Door open holding latch control cable**

**Removal**

**19** Remove the door inner trim panel, as described in Section 11.

**20** Using a sharp knife, carefully release the plastic sealing sheet from the adhesive bead and remove the sheet from the door. If care is taken, it may just be possible to remove the sheet in one piece and re-use it when refitting (see illustration).

**21** At the upper end of the cable, release the outer cable sheath from the mounting bracket using a small screwdriver. Disconnect the inner cable end fitting from the operating lever (see illustrations).

**22** At the lower end of the cable, slacken the screw securing the cable clamp plate to the door and slide the cable out of the clamp. Disconnect the cable end from the operating lever on the latch.

**23** Release the rubber grommets and remove the cable from the door.

**Refitting**

**24** Refitting is a reversal of removal, but adjust the cable as described in paragraphs 17 and 18 before tightening the cable clamp plate screw. Fit a new sealing sheet to

the door if the original was damaged in any way during removal. On completion, refit the door inner trim panel as described in Section 11.

**Child lock**

**Removal**

**25** Remove the exterior door handle as described previously.

**26** Working through the exterior door handle aperture, depress the tabs on the side of the child lock using pointed-nose pliers (see illustration).

**27** Withdraw the child lock, together with the operating rod, from the outside of the door (see illustration).

**Refitting**

**28** Refitting is a reversal of removal.

**Lock control unit**

**Note:** The lock control unit is riveted to the door. Ensure that new rivets of the correct size are available for refitting.

**Removal**

**29** Remove the door inner trim panel, as described in Section 11.

**30** Remove the child lock as described previously.

**31** Disconnect the upper end of the door open holding latch control cable as described in paragraph 21.

**32** Note the fitted positions and the correct routing of all the link rods, then disconnect the link rods from the control unit operating levers.

**33** Disconnect the wiring connector from the lock control motor (see illustration).

**34** Using a 6.0 mm drill, drill off the rivet heads securing the control unit to the door. Undo the remaining retaining screw and remove the unit from the door.

**Refitting**

**35** Refitting is a reversal of removal, ensuring that all link rods are correctly positioned. On completion, refit the door inner trim panel as described in Section 11.

**14 Hinged rear door handle and lock components – removal and refitting**



**Exterior door handle**

**Note:** The exterior handle is riveted to the door. Ensure that new rivets of the correct size are available for refitting.

**Removal**

**1** Remove the door inner trim panel, as described in Section 11.

**2** Remove the plastic cap from the edge of the door and disconnect the door handle

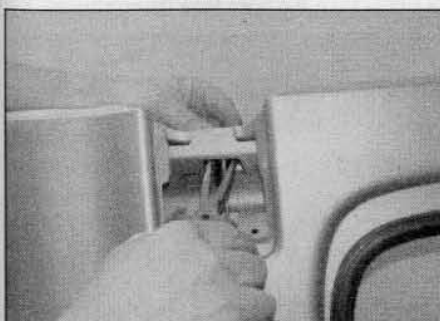

**13.26** Depress the tabs on the side of the child lock using pointed-nose pliers

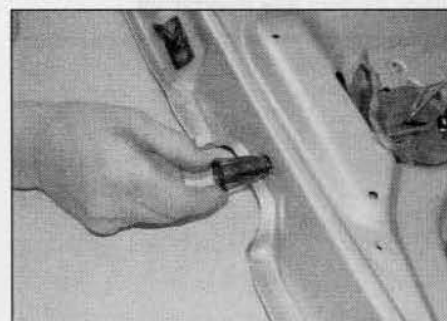

**13.27** Withdraw the child lock, together with the operating rod, from the outside of the door

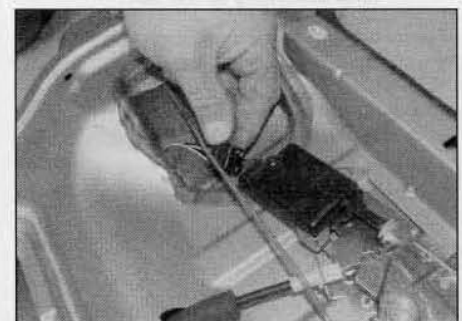

**13.33** Disconnect the wiring connector from the lock control motor

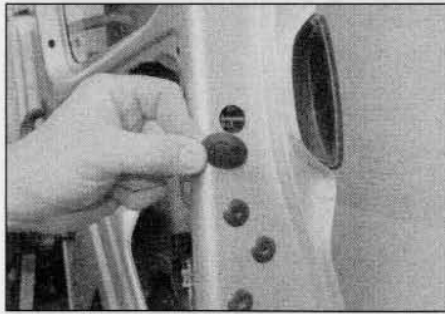

14.2a Remove the plastic cap from the edge of the door . . .

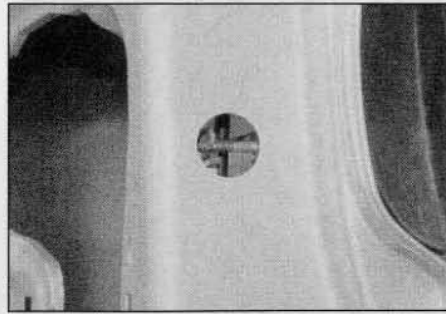

14.2b . . . and disconnect the door handle operating rod from the door lock lever

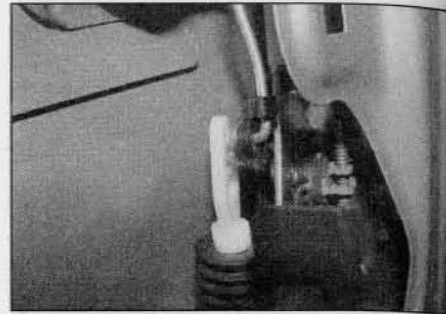

14.6 Disconnect the lock cylinder link rod from the door lock motor

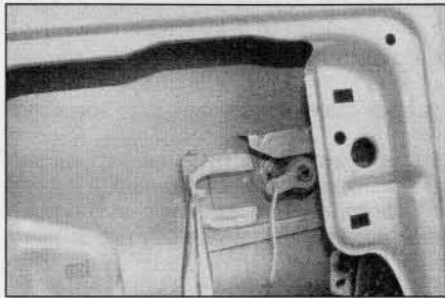

14.7 Extract the large horseshoe-shaped retaining clip from the rear of the lock cylinder

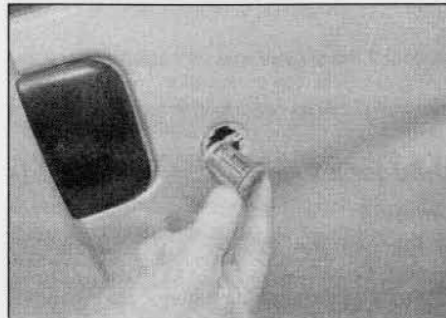

14.8 Remove the lock cylinder and link rod from outside the door

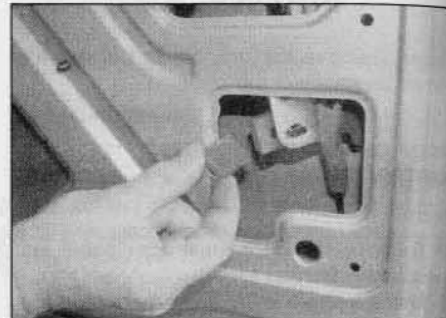

14.11 Disconnect the wiring connector from the door lock motor

operating rod from the door lock lever (see illustrations).

3 Using a 6.0 mm drill, drill off the rivet heads from the outside and remove the handle from the door.

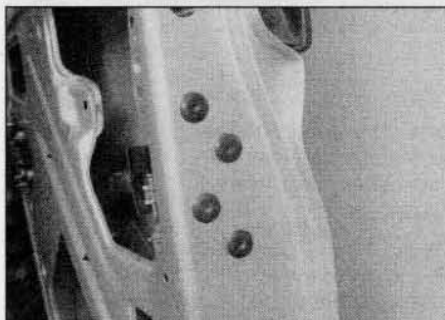

14.12 Undo the four bolts securing the lock assembly to the door

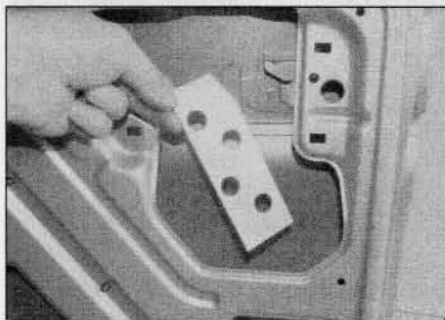

14.13 Manoeuvre the lock from its location and recover the spacer plate

#### Refitting

4 Refitting is a reversal of removal. Before refitting the inner trim panel, check the operation of the handle mechanism. If necessary adjust by repositioning the operating rod on the door lock lever. On completion, refit the inner trim panel as described in Section 11.

#### Lock cylinder

##### Removal

5 Remove the door inner trim panel, as described in Section 11.

6 Working inside the door, disconnect the lock cylinder link rod from the door lock motor (see illustration).

7 Using pliers, extract the large horseshoe-shaped retaining clip from the rear of the lock cylinder (see illustration).

8 Remove the lock cylinder and link rod from outside the door (see illustration).

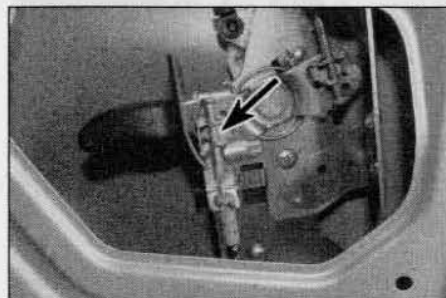

14.15a Note the fitted position of the threaded ends (arrowed) of the latch operating cables . . .

#### Refitting

9 Refitting is a reversal of removal. On completion, refit the door inner trim panel as described in Section 11.

#### Door lock

##### Removal

10 Remove the door inner trim panel, as described in Section 11.

11 Disconnect the wiring connector from the door lock motor (see illustration).

12 Undo the four bolts securing the lock assembly to the door (see illustration).

13 Manoeuvre the lock from its location and recover the spacer plate (see illustration).

14 Disconnect the lock cylinder link rod from the door lock lever.

15 Note the fitted position of the threaded ends of the upper and lower door latch operating cables. Disconnect the cables from the door lock levers and remove the lock assembly from the door (see illustrations).

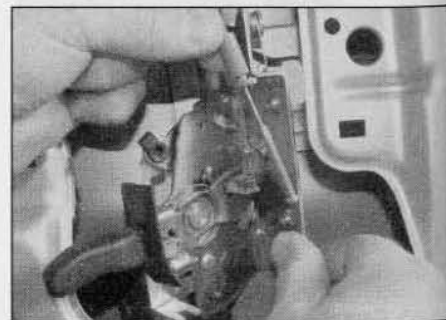

14.15b . . . then disconnect the cables from the door lock levers



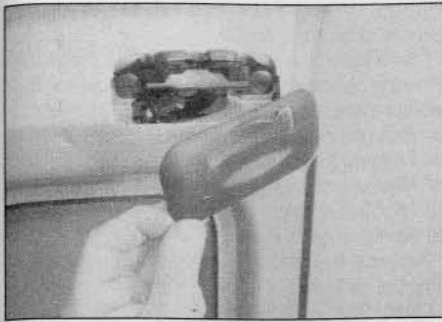

14.18 Carefully prise off the plastic trim from the door latch

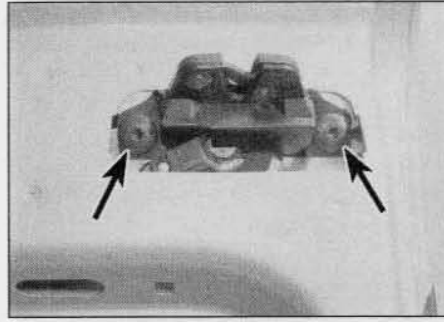

14.19 Undo the two door latch retaining screws

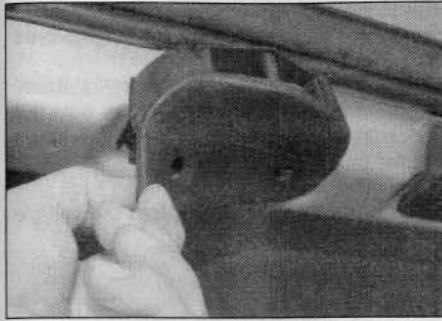

14.22 Ease off the protective rubber cover over the upper striker

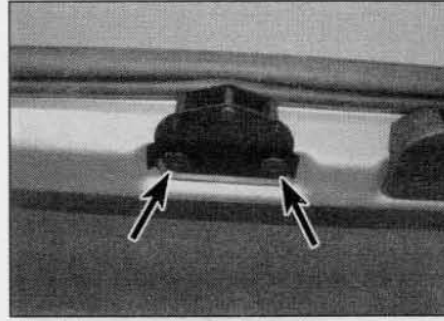

14.23 Striker retaining bolts (arrowed)

**Refitting**

16 Refitting is a reversal of removal. Before refitting the inner trim panel, check the operation and synchronisation of the upper and lower door latches. If necessary, adjust by repositioning the ends of the operating cables on the door lock levers. On completion, refit the inner trim panel as described in Section 11.

**Upper and lower door latches**

**Removal**

- 17 Remove the door lock as described previously.
- 18 Carefully prise off the plastic trim from the door latch (see illustration).
- 19 Undo the two door latch retaining screws and remove the door latch and operating cable from the door (see illustration).

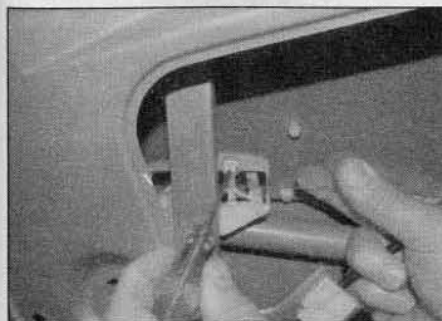

15.4 Depress the tab on the window regulator lifting channel, lift the glass slightly and free the glass from the support

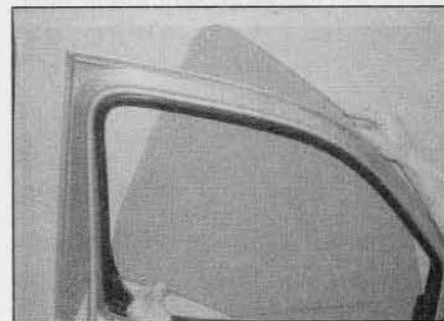

15.5 Lower the glass at the front and remove it from the outside of the door frame

the striker should be altered (the securing bolt holes are elongated) until satisfactory lock operation is obtained. Use the marks made prior to removal, if appropriate.

**15 Front door window glass and regulator – removal and refitting**



**Note:** A new door sealing sheet may be required on refitting.

**Window glass**

**Removal**

- 1 Remove the door inner trim panel, as described in Section 11.
- 2 Using a sharp knife, carefully release the plastic sealing sheet from the adhesive bead and remove the sheet from the door. If care is taken, it may just be possible to remove the sheet in one piece and re-use it when refitting (see illustration 12.7).
- 3 Position the window approximately three quarters of the way down.
- 4 Depress the tab on the window regulator lifting channel, lift the glass slightly and free the glass from the support (see illustration).
- 5 Lower the glass at the front and remove it from the outside of the door frame (see illustration).

**Refitting**

- 6 Refitting is a reversal of removal. Fit a new sealing sheet to the door if the original was damaged in any way during removal. On completion, refit the door inner trim panel as described in Section 11.

**Door window regulator**

**Removal**

- 7 Release the window glass from the regulator lifting channel as described in paragraphs 1 to 4 above.
- 8 Slide the window glass up to the fully closed position and secure it in this position with masking tape over the top of the door frame.
- 9 Undo the two lower bolts securing the window glass rear guide channel to the door (see illustration).

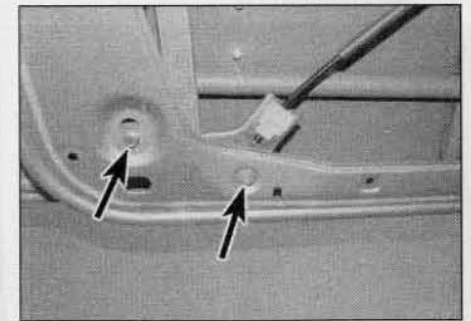

15.9 Undo the two lower bolts (arrowed) securing the window glass rear guide channel to the door



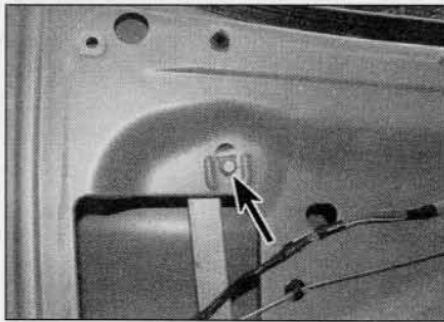

**15.10 Undo the upper bolt (arrowed) securing the window glass rear guide channel to the door**

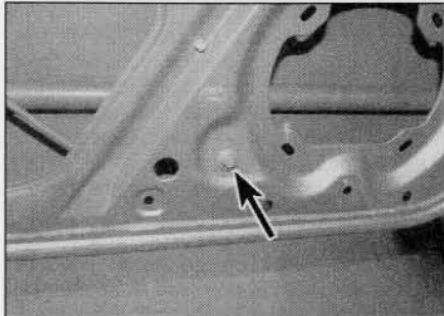

**15.12 Undo the lower bolt (arrowed) securing the window regulator to the door**

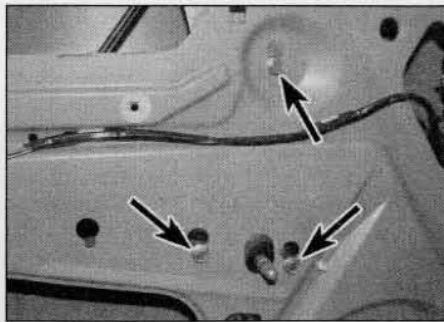

**15.11 Slacken the three bolts (arrowed) securing the window regulator to the door**

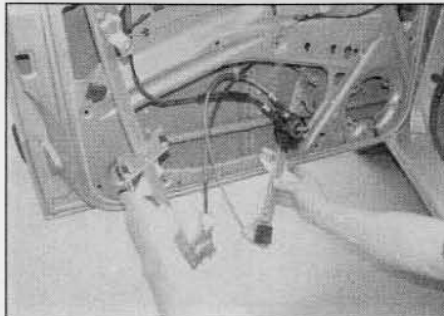

**15.14 Remove the regulator assembly out through the door aperture**



**Tailgate**

**Note:** New tailgate aperture sealing sheets may be required on refitting.

**Removal**

- 1 Remove the tailgate trim panel as described in Section 28.
- 2 Using a sharp knife, carefully release the plastic sealing sheets from the adhesive beads and remove the sheets from the tailgate. If care is taken, it may just be possible to remove the sheets in one piece and re-use them when refitting (see illustration).
- 3 Disconnect the rear window washer hose

from the wiper motor, and release the hose from its retaining clips.

4 Disconnect the wiring connectors from the following components with reference to the relevant Sections of this Chapter, and Chapter 12:

- a) Rear window wiper motor.
- b) Tailgate lock motor.
- c) Rear window demister elements.
- d) High-level stop-light.
- e) Number plate lights.

5 Release the wiring harness retaining clips from the tailgate.

6 Check that all wiring connectors have been disconnected, then release the wiring harness grommet and withdraw the harness from the tailgate.

7 Undo the two screws and remove the hinge cover plates each side, from the tailgate (see illustration).

8 With the aid of an assistant, suitably support the tailgate, then prise out the support strut spring clips, and pull the struts from the balljoints on the body.

9 Unscrew the tailgate hinge pin on each side and carefully lift the tailgate from the vehicle (see illustration).

**Refitting**

10 If a new tailgate is to be fitted, transfer all serviceable components (lock mechanism, wiper motor, etc) to it, with reference to the relevant procedures in this Chapter, and in Chapter 12.

11 Refitting is a reversal of removal, bearing in mind the following points:

- a) Fit new sealing sheets to the tailgate if the original sheets were damaged in any way during removal.
- b) If necessary, adjust the rubber buffers to obtain a good fit when the tailgate is shut.
- c) If necessary, adjust the position of the tailgate lock striker to achieve satisfactory lock operation.
- d) On completion, refit the tailgate trim panel as described in Section 28.

**Support struts**

**Refit**

12 Support the tailgate in the open position, with the help of an assistant, or using a stout piece of wood.

13 Using a suitable flat-bladed screwdriver, release the spring clip, and pull the support

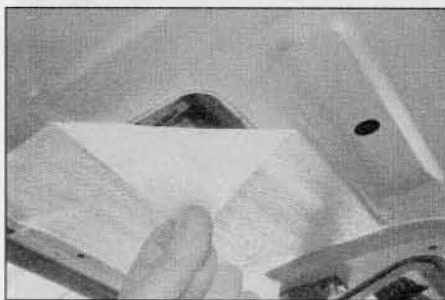

**16.2 Carefully release the plastic sealing sheets from the adhesive beads and remove the sheets from the tailgate**



**16.7 Undo the two screws and remove the hinge cover plates from the tailgate**

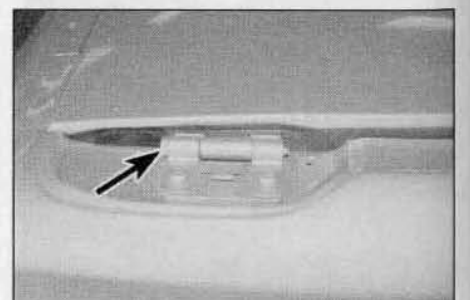

**16.9 Unscrew the tailgate hinge pin (arrowed) on each side**

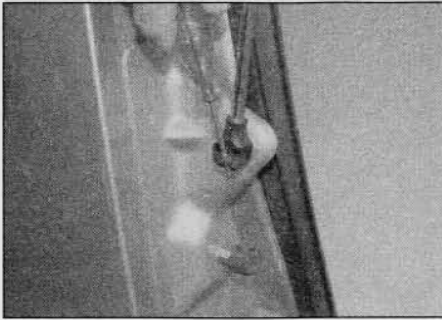

**16.13** Release the spring clip, and pull the support strut from its balljoint on the body

strut from its balljoint on the body (see illustration).

**14** Similarly, release the strut from the balljoint on the tailgate, and withdraw the strut from the vehicle.

**Refitting**

**15** Refitting is a reversal of removal, but ensure the spring clips are correctly engaged.

**17 Tailgate lock components – removal and refitting**

**Tailgate lock**

**Note:** A new tailgate aperture sealing sheet may be required on refitting.

**Removal**

**1** Remove the tailgate trim panel as described in Section 28.

**2** Using a sharp knife, carefully release the centre plastic sealing sheet from the adhesive bead and remove the sheet from the tailgate. If care is taken, it may just be possible to remove the sheet in one piece and re-use it when refitting.

**3** Disconnect the link rod from the tailgate lock cylinder and tailgate lock lever (see illustration).

**4** Undo the nut securing the lock cylinder to the exterior handle and remove the lock cylinder through the tailgate aperture (see illustrations).

**5** Undo the remaining retaining nut securing

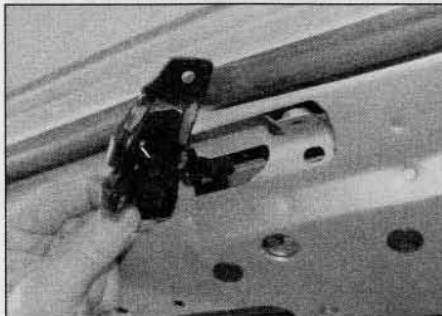

**17.6b** ... and withdraw the latch unit from the tailgate

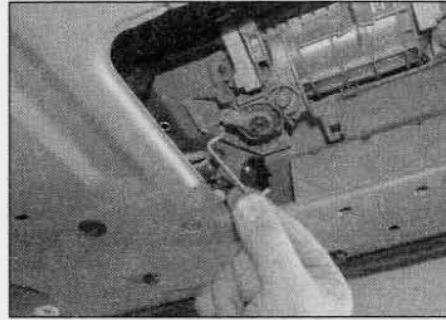

**17.3** Disconnect the link rod from the tailgate lock cylinder and tailgate lock lever

the exterior handle to the tailgate. Disengage the operating rod from the tailgate lock and remove the exterior handle from the tailgate (see illustrations).

**6** Undo the two screws and withdraw the latch unit from the tailgate. As the latch is

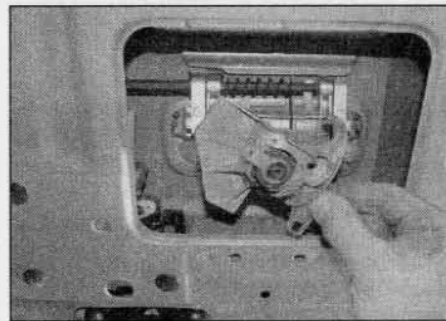

**17.4b** ... and remove the lock cylinder through the tailgate aperture

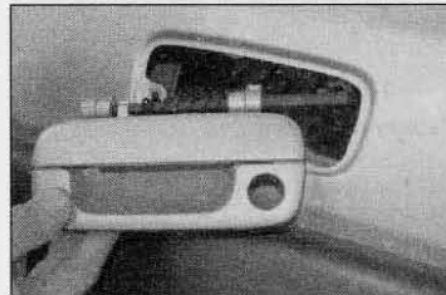

**17.5b** ... then disengage the operating rod and remove the exterior handle from the tailgate

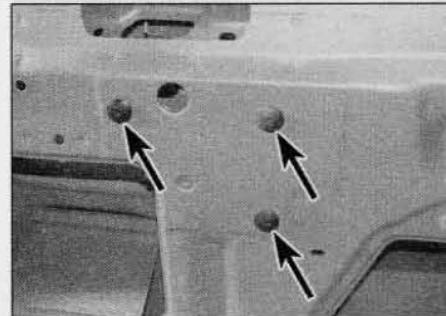

**17.7a** Undo the three tailgate lock retaining screws (arrowed) ...

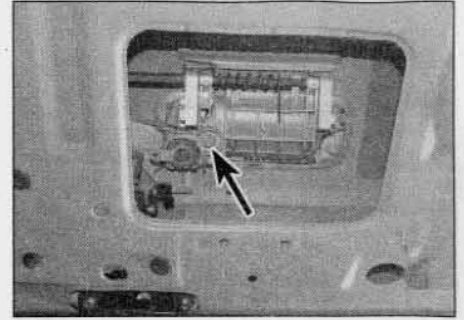

**17.4a** Undo the nut (arrowed) securing the lock cylinder to the exterior handle ...

withdrawn, disconnect the link rod from the latch lever (see illustrations).

**7** Undo the three tailgate lock retaining screws. Withdraw the lock through the tailgate aperture and disconnect the wiring connector (see illustrations).

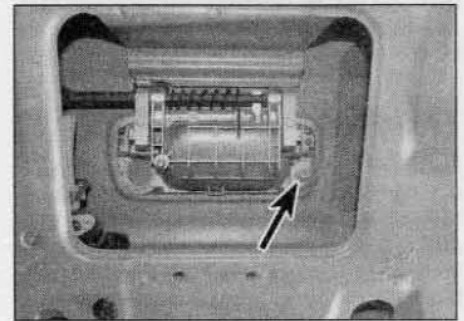

**17.5a** Undo the remaining retaining nut (arrowed) ...

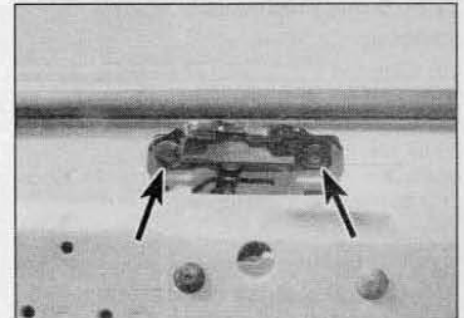

**17.6a** Undo the two screws (arrowed) ...

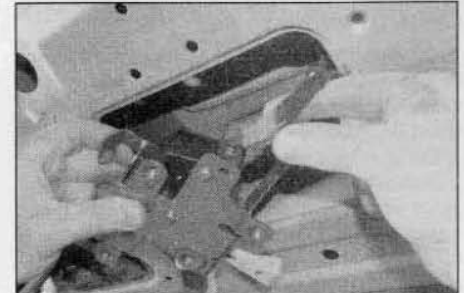

**17.7b** ... then withdraw the lock through the tailgate aperture and disconnect the wiring connector



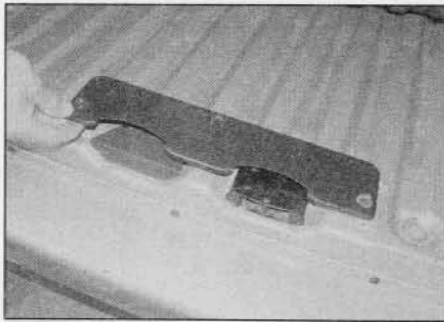

**17.10 Undo the three screws and remove the lock striker cover plate from the floor**

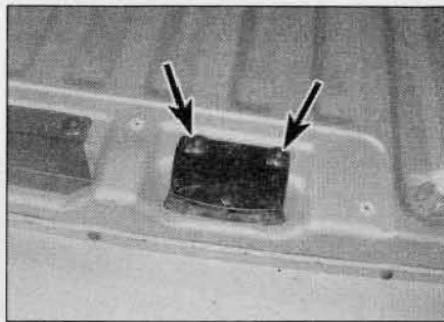

**17.11 Unscrew the two securing bolts (arrowed) and remove the striker from the body**

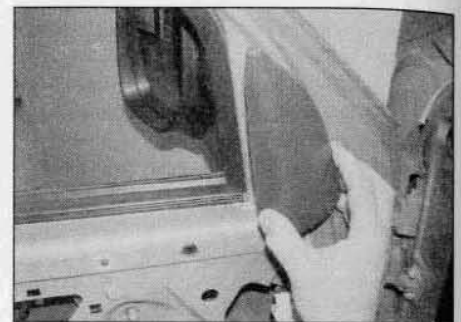

**19.2 Carefully prise off the mirror trim panel**

**Refitting**

**8** Refitting is a reversal of removal. Fit a new sealing sheet to the tailgate if the original was damaged in any way during removal. If necessary, adjust the position of the tailgate lock striker to achieve satisfactory lock operation. On completion, refit the tailgate trim panel as described in Section 28.

**Tailgate lock striker**

**Removal**

**9** Fold back the floor covering for access to the lock striker cover plate.

**10** Undo the three screws and remove the lock striker cover plate from the floor (see illustration).

**11** Mark the position of the striker on the body, for use when refitting. Unscrew the two securing bolts, and remove the striker from the body (see illustration).

**Refitting**

**12** Refitting is a reversal of removal. Before tightening the securing bolts, the position of the striker should be altered (the securing bolt holes are elongated) until satisfactory lock operation is obtained. Use the marks made prior to removal, if appropriate.

**18 Central locking components – removal and refitting**



**Control unit**

**1** On early models, the central locking system is controlled by an electronic control unit, located in the sill panel to the rear of the front door, on the driver's side.

**2** On later models, the central locking system is controlled by the Built-in Systems Interface (BSI) which is the vehicle central computer controlling the main body electrical system functions. The unit is located under the facia on the left-hand side. Refer to Chapter 12 for further information.

**3** Should any problems be experienced with the operation of the central locking system or

any of the other functions controlled by the BSI, the vehicle should be taken to a Peugeot/Citroën dealer for diagnostic investigation.

**Front door lock motor**

**4** The motor is integral with the door lock assembly. Removal and refitting of the lock assembly is described in Section 12.

**Sliding side door lock motor**

**5** The motor is integral with the door lock assembly. Removal and refitting of the lock assembly is described in Section 13.

**Hinged rear door lock motor**

**6** The motor is integral with the door lock assembly. Removal and refitting of the lock assembly is described in Section 14.

**Tailgate lock motor**

**7** The motor is integral with the door lock assembly. Removal and refitting of the lock assembly is described in Section 17.

**Remote control transmitter**

**Battery renewal**

**8** The battery should be renewed with a type CR 2016 (3 volt) battery.

**9** Using a small screwdriver, undo the screw, carefully prise the two halves of the transmitter apart, and remove the battery.

**10** Fit the new battery and reassemble the transmitter.

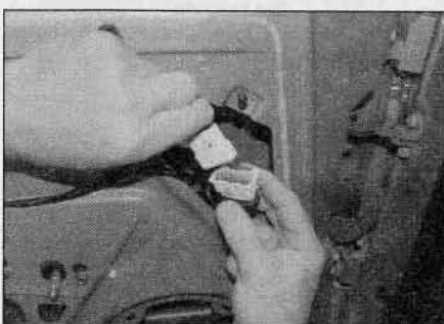

**19.3 Disconnect the mirror wiring connector**

**Initialisation**

**11** To initialise the unit after renewing the battery, switch off the ignition, then switch on the ignition and immediately press the locking button. Switch off the ignition and remove the key from the ignition lock.

**19 Exterior mirrors and mirror glass – removal and refitting**



**Exterior mirror assembly**

**Removal**

**1** Ensure the ignition is turned off.  
**2** Remove the door inner trim panel as described in Section 11, then carefully prise off the mirror trim panel (see illustration).

**3** Disconnect the mirror wiring connector (see illustration).

**4** Undo the three retaining screws and remove the mirror from the door frame (see illustration).

**Refitting**

**5** Refitting is a reversal of removal.

**Exterior mirror glass**

**Removal**

**6** Tilt the glass downward then reach behind and pull the top of the glass away from the

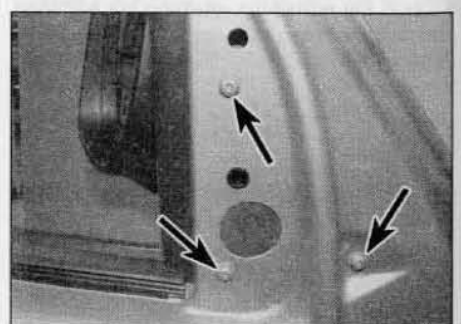

**19.4 Undo the three retaining screws (arrowed) and remove the mirror from the door frame**



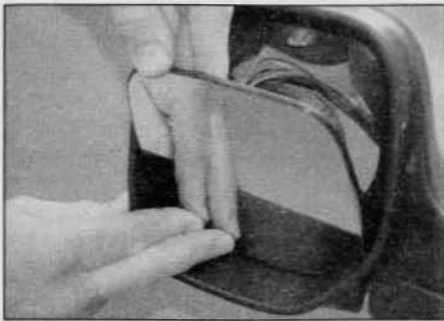

**19.6** Tilt the mirror glass downward then reach behind and pull the top of the glass away from the adjuster plate

adjuster plate to release the retaining clips (see illustration).

7 Withdraw the glass, and disconnect the wiring connector, if fitted (see illustration).

**Refitting**

8 Where applicable, reconnect the wiring connectors, then push the mirror glass into the mirror until it locks into position.



**19.7** Withdraw the mirror glass, and disconnect the wiring connector

which is considered beyond the scope of the home mechanic. It is difficult, unless one has plenty of practice, to obtain a secure, waterproof fit. Furthermore, the task carries a high risk of breakage; this applies especially to the laminated glass windscreen. In view of this, owners are strongly advised to have this sort of work carried out by one of the many specialist windscreen fitters.

**20 Windscreen, tailgate and rear door window glass – general information**

These areas of glass are secured by the tight fit of the weatherstrip in the body aperture, and are bonded in position with a special adhesive. Renewal of such fixed glass is a difficult, messy and time-consuming task,

**21 Opening side and door window glass – removal and refitting**

**Side window glass**

**Removal**

1 Undo the three screws securing the window glass closing catch to the body (see illustration).

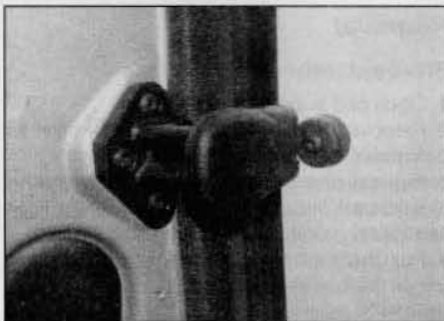

**21.1** Undo the three screws securing the side window glass closing catch to the body

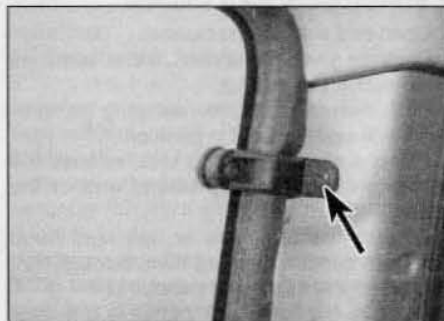

**21.2** Undo the screws (arrowed) securing the window glass hinges to the body

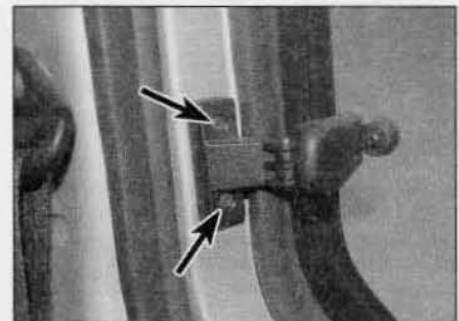

**21.4** Undo the two screws (arrowed) securing the side door glass closing catch to the door

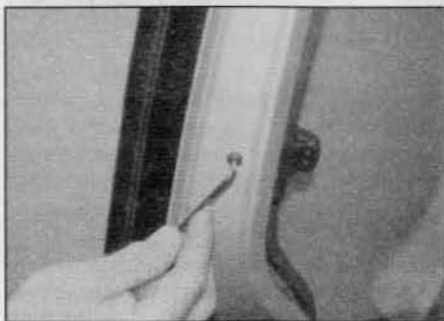

**21.5** Undo the third screw, securing the catch to the outer edge of the door frame

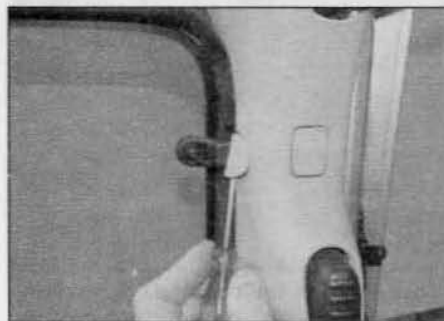

**21.6a** Lift up the trim caps ...

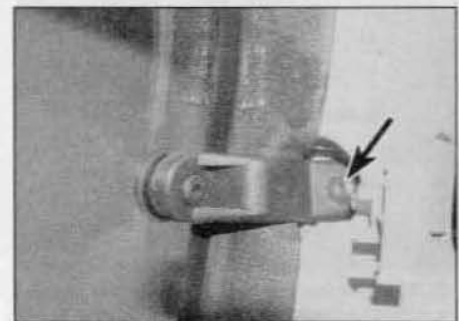

**21.6b** ... and undo the screws (arrowed) securing the window glass hinges to the door

2 Support the glass, then undo the upper and lower screws securing the window glass hinges to the body (see illustrations). Lift the glass from its location.

**Refitting**

3 Refitting is a reversal of removal.

**Side door glass**

**Removal**

4 Undo the two screws securing the window glass closing catch to the door (see illustration).

5 Open the door and undo the third screw, securing the catch to the outer edge of the door frame (see illustration).

6 Support the glass, then lift up the trim caps and undo the upper and lower screws securing the window glass hinges to the door (see illustrations). Lift the glass off the door.

**Refitting**

7 Refitting is a reversal of removal.

**22 Sunroof – general information**

The factory-fitted sunroof is of the electric tilt/slide type.

Due to the complexity of the sunroof mechanism, considerable expertise is required to repair, renew or adjust the sunroof components successfully. Removal of the roof first requires the headlining to be removed,

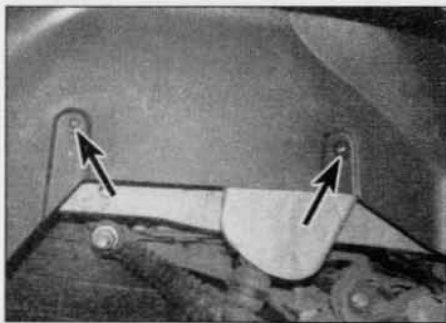

**23.5** Undo the two nuts (arrowed) securing the rear wheel arch liner to the body

which is a tedious operation, and not a task to be undertaken lightly. Any problems with the sunroof should be referred to a Peugeot/Citroën dealer.

**23 Body exterior fittings – removal and refitting**



**Wheel arch liners**

**Front**

**1** Firmly apply the handbrake, then jack up the front of the car and support it securely on axle stands (see *Jacking and vehicle support*). Remove the relevant front roadwheel.

**2** The wheel arch liners are secured by a combination of screws, and push-fit clips. The screws attach the liner to the underside of the front bumper (and on some models, to the front wing).

**3** The push-fit clips can be released using a forked-shaped tool, although, in some instances extreme force will be needed.

**Rear**

**4** Chock the front wheels then jack up the rear of the car and securely support it on axle stands (see *Jacking and vehicle support*). Remove the relevant rear roadwheel.

**5** Undo the two nuts securing the liner to the body (see illustration).

**6** Undo the screw securing the liner to the

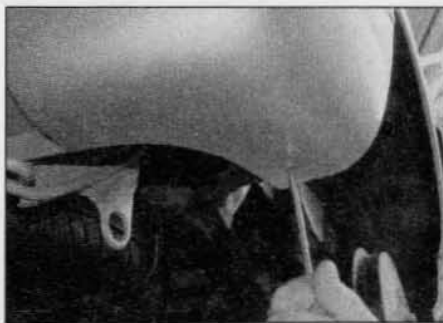

**23.6a** Undo the screw securing the liner to the rear bumper . . .

rear bumper and remove the liner from under the wheel arch (see illustrations).

**Body trim strips and badges**

**7** The various body trim strips and badges are held in position with a special adhesive membrane. Removal requires the trim/badge to be heated, to soften the adhesive, and then cut away from the surface. Due to the high risk of damage to the vehicle paintwork during this operation, it is recommended that this task should be entrusted to a Peugeot/Citroën dealer.

**24 Scuttle grille panel – removal and refitting**



**Removal**

**Pre-September 2002 models**

**1** Open and support the bonnet.  
**2** Remove the windscreen wiper arms as described in Chapter 12.

**3** Undo the retaining screw securing the right-hand side scuttle panel in position.

**4** Using a suitable forked tool, release the securing clip at the right-hand end of the panel.

**5** Release the fasteners on the right-hand side grille panel by turning them through 90°, then lift off the right-hand panel.

**6** Remove the left-hand panel in a similar fashion.



**24.10** Release the fasteners on the right-hand side scuttle grille panel, then lift off the right-hand panel



**24.11** Remove the left-hand scuttle grille panel in a similar fashion

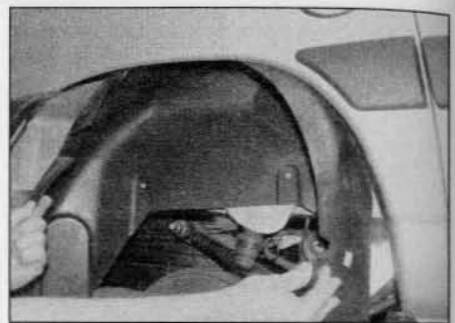

**23.6b** . . . and remove the liner from under the wheel arch

**Post-September 2002 models**

**7** Open and support the bonnet.

**8** Remove the windscreen wiper arms as described in Chapter 12.

**9** Undo the retaining screw securing the corner of the panel to the front wing.

**10** Release the fasteners on the right-hand side grille panel by turning them through 180°, then lift off the right-hand panel (see illustration).

**11** Remove the left-hand panel in a similar fashion (see illustration).

**Refitting**

**12** Refitting is a reversal of removal.

**25 Radiator grille – removal and refitting**



**Removal**

**Pre-September 2002 models**

**1** Open and support the bonnet.  
**2** Remove the direction indicator light units as described in Chapter 12.

**3** Release the outer retaining clip securing plastic trim under the direction indicator light unit locations on each side.

**4** Pull the trim outwards to release the lug under the headlight, then slide the trim away from the centre of the car to remove (see illustration).



**25.4** Pull the trim outwards to release the lug under the headlight, then slide the trim away from the centre of the car to remove – early models

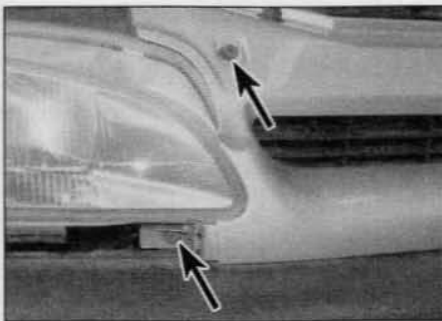

25.5 Undo the two retaining screws (arrowed) each side – early models

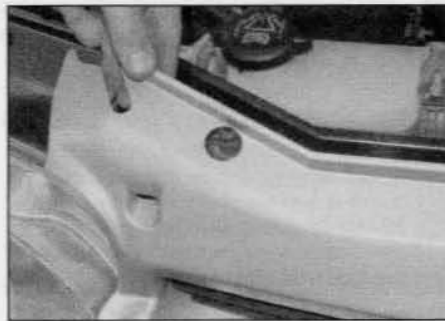

25.6a Lift the grille over the bonnet height adjuster buffers ...

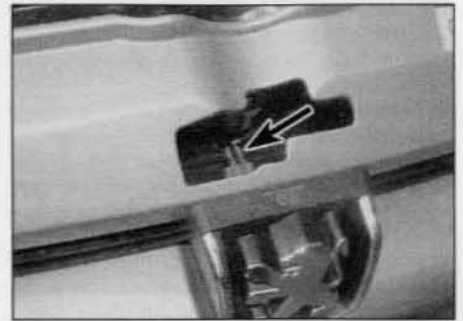

25.6b ... and pull it sharply forward to release the central locating tangs (arrowed) – early models

5 Undo the two retaining screws each side (see illustration).

6 Lift the grille over the bonnet height adjuster buffers and pull it sharply forward to release the central locating tangs (see illustrations). Remove the grille from the car.

#### Post-September 2002 models

7 Undo the four screws along the top edge, securing the grille in position (see illustration).

8 Lift the grille upwards to disengage the centre locating lug and the pegs on each side (see illustrations). Remove the grille from the car.

#### Refitting

9 Refitting is a reversal of removal.

### 26 Seats – removal and refitting

#### Front seats



**Warning:** Depending on model, the front seats may be equipped with seat belt pretensioners, and side airbags may be built into the outer sides of the seats. Where side airbags are fitted, refer to Chapter 12 for the precautions which should be observed when dealing with an airbag system. Do not tamper with the seat belt pretensioner unit in any way, and do not attempt to test

the unit. Note that the unit is triggered if the mechanism is supplied with an electrical current (including via an ohmmeter), or if the assembly is subjected to a temperature of greater than 100°C.

1 On models with seat belt pretensioners, observe the following precautions before attempting to remove the seat:

- Remove the ignition key.
- Disconnect the battery negative terminal (refer to 'Disconnecting the battery' in the Reference Chapter), and wait for two minutes before carrying out any further work.

#### Removal

2 Where applicable, de-activate the airbag system (see Chapter 12) before attempting to remove the seat.

3 On later models, carefully prise off the plastic panels for access to the seat belt mountings.

4 Move the seat fully forwards.

5 Remove the bolts (one on each side) securing the rear of the seat rails to the vehicle floor.

6 Move the seat fully rearwards.

7 Remove the bolts (one bolt on each side) securing the front of the seat frame to the floor. Note that on some models, the outer bolt may be located under a trim cover.

8 Tip the seat backwards and disconnect the seat wiring connectors. Release the wiring harness from the retaining clips on the seat then remove the seat from the passenger compartment.

#### Refitting

9 Refitting is a reversal of removal. Where applicable, reactivate the airbag system as described in Chapter 12, before reconnecting the battery.

#### Rear seats

10 Lift off the trim caps (where fitted) then undo the mounting bolts at the front of the seat cushion.

11 Press the seat back release control and tip the seat back forward to release the floor catches.

12 Pull and tilt the seat towards the front then remove it from the car.

13 With the seat removed, undo the lower pivot bolts and separate the seat back from the cushion.

#### Refitting

14 Refitting is a reversal of removal.

### 27 Seat belt components – removal and refitting

**Note:** Record the positions of the washers and spacers on the seat belt anchors, and ensure they are refitted in their original positions.

#### Front seat belt

#### Removal

1 On models with a sliding side door, remove



25.7 Undo the four screws (arrowed) along the top edge of the grille

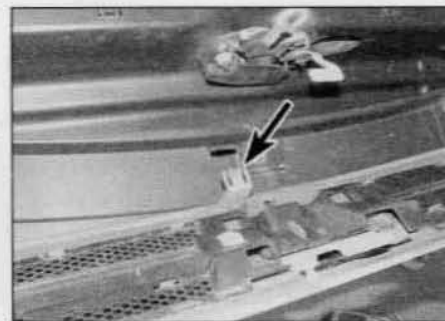

25.8a Lift the grille upwards to disengage the centre locating lug (arrowed) ...

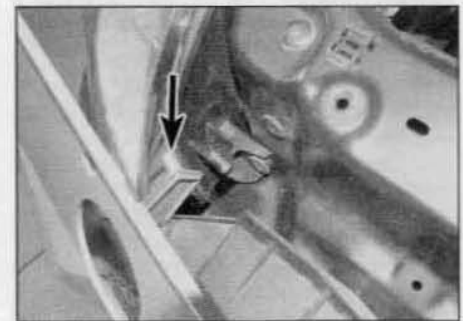

25.8b ... and the pegs on each side (arrowed)



the centre pillar trim panels as described in Section 28. On models without a sliding side door, remove the side trim panel as described in Section 28.

2 Prise off the trim cap, then undo the lower belt anchor bolt, and recover the washer.

3 Undo the inertia reel mounting bolt.

4 Using a 3.5 mm drill bit, drill out the pop rivet securing the belt guide to the centre pillar.

5 Withdraw the inertia reel from the door pillar, then withdraw the seat belt assembly from the vehicle.

#### Refitting

6 Refitting is a reversal of removal, using a new pop rivet to secure the seat belt guide. Ensure that all washers and/or spacers are positioned as noted before removal, and tighten all mounting bolts to the specified torque.

#### Front seat belt stalk – models without seat belt pretensioners

##### Removal

7 Remove the securing screws or release the clips, as applicable, and remove the trim panel from the side of the seat.

8 Each stalk is secured to the front seat frame by a bolt and washer.

##### Refitting

9 Tighten the securing bolt to the specified torque.

#### Front seat belt stalk – models with seat belt pretensioners



**Warning:** On models with seat belt pretensioners, observe the following precautions before attempting to remove the seat belt stalk assembly:

a) Remove the ignition key.

b) Disconnect the battery negative terminal (refer to 'Disconnecting the battery' in the Reference Chapter), and wait for two minutes before carrying out any further work.



**Warning:** Do not tamper with the pretensioner unit in any way, and do not attempt to test the unit. Note that the unit is triggered if the mechanism is supplied with an electrical current (including via an ohmmeter), or if the assembly is subjected to a temperature of greater than 100°C.

##### Removal

10 The seat belt stalk is an integral part of the seat belt pretensioner mechanism.

11 Remove the front seat as described in Section 26.

12 Undo the securing bolt and remove the clamp from the pretensioner body.

13 Disconnect the pretensioner wiring connector from the tensioner unit.

14 Undo the pretensioner securing bolt and withdraw the pretensioner and seat belt stalk assembly from the seat.

**Warning:** Do not hold the tensioner by the buckle or by the cable – only hold the unit around the tensioner body.

##### Refitting

15 Refitting is a reversal of removal, but observe the following precautions:

a) Before refitting, ensure that the battery negative terminal is disconnected, and that the ignition is switched off.

b) Do not touch the seat belt buckle when the ignition is first switched on.

#### Rear seat belt

##### Removal

16 Remove the luggage compartment side trim panel as described in Section 28.

17 Unclip the trim plate, then unbolt the upper seat belt anchor bolt.

18 Undo the anchor bolt securing the seat belt inertia reel to the vehicle body and remove the reel and seat belt from the car.

19 To remove the seat belt buckles, fold forward the rear seats forward and undo the bolt securing the buckles to the rear seat mounting.

20 To remove the centre seat belt inertia reel, the seat must be partially dismantled. This work should be entrusted to a Peugeot/Citroën dealer.

##### Refitting

21 Refitting is a reversal of removal. Tighten the seat belt mounting bolts to the specified torque.

#### 28 Interior trim – removal and refitting



**Note:** There are numerous combinations of interior trim layout according to model year, vehicle type and whether or not sliding side doors are fitted. The following information is a guide to the most common arrangements.

#### Door inner trim panel

1 Refer to Section 11.

#### Front pillar trim panel

##### Removal

2 Prise the weatherstrip from the front door aperture in the vicinity of the door pillar.

3 Starting at the top, carefully pull the trim away from the pillar to release the internal retaining lugs.

4 Lift the trim up to disengage it from the side of the fascia and remove it from the vehicle.

##### Refitting

5 Refitting is a reversal of removal, but ensure that all retaining clips are fully engaged and that the weatherstrip is fully seated.

#### Centre pillar upper trim panel

##### Removal

6 Open the front door and, where applicable,

the sliding side door, and prise the weatherstrips from the centre pillar.

7 Unclip the trim plate, then unbolt the upper seat belt anchor bolt.

8 Undo the screw securing the lower edge of the upper trim panel to the door pillar.

9 Pull the upper panel from the pillar to release the securing clips, disengage it from the lower panel and remove it from the car.

##### Refitting

10 Refitting is a reversal of removal. Tighten the seat belt anchor bolt to the specified torque.

#### Centre pillar lower trim panel – models with a sliding side door

##### Removal

11 Remove the centre pillar upper trim panel as described previously.

12 Remove the trim cap, then unscrew the front seat belt lower anchor bolt.

13 Undo the retaining screw and carefully lift the rear edge of the front sill trim upwards.

14 Carefully prise the lower trim panel away from the pillar, to release the internal clips, then disengage the seat belt and remove the trim panel.

##### Refitting

15 Refitting is a reversal of removal. Tighten the seat belt anchor bolt to the specified torque.

#### Side trim panel – models without a sliding side door

##### Removal

16 Remove the centre pillar upper trim panel as described previously.

17 Undo the four retaining screws and remove the lower section of the panel.

18 Using a small screwdriver, carefully prise off the outer part of the grab handle. Undo the two retaining bolts and disengage the inner part of the handle from the body.

19 Undo the remaining retaining screws and carefully prise the trim panel away from the body, to release the internal clips.

##### Refitting

20 Refitting is a reversal of removal.

#### Sliding side door upper trim panel

##### Removal

21 Undo the four screws securing the panel to the roof above the sliding side door aperture.

22 Carefully pull the panel from its location and remove it from the vehicle.

##### Refitting

23 Refitting is a reversal of removal.

#### Front door sill trim panel

##### Removal

24 Prise the weatherstrip from the lower edge of the front door aperture.

25 Undo the retaining screw at the rear of the panel.



28.36 Carefully prise the cover(s) off the tailgate grab handle(s)

26 Carefully prise the front door sill trim away from the sill to release its retaining clips and remove it from the vehicle.

#### Refitting

27 Refitting is a reversal of removal, but ensure that all retaining clips are fully engaged and that the weatherstrip is fully seated.

#### Luggage compartment side trim panel

##### Removal

28 Prise the weatherstrip from the load compartment aperture in the vicinity of the side panel.

29 Remove the trim cap, then unscrew the rear seat belt lower mounting bolt.

30 On models with hinged rear doors, undo the bolts and remove the door check strap bracket.

31 Release the seat belt guide trim from the panel and slide the seat belt through the slit in the guide.

32 If removing the right hand-side panel, remove the jack and tool storage access cover from the centre of the panel, then undo the retaining screws around the periphery of the aperture.

33 Working around the panel, undo all the retaining screws and visible attachments.

34 Carefully prise the side panel away from the body, to release the internal clips, then remove the trim panel.

##### Refitting

35 Refitting is a reversal of removal, but ensure that all retaining clips are fully engaged and that the weatherstrip is fully seated.

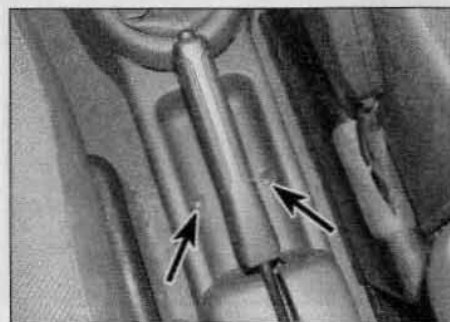

29.3 Undo the two screws (arrowed) on each side of the handbrake lever



28.37 Pull the trim panel sharply away from the tailgate to release the internal retaining clips

#### Tailgate trim panel

##### Removal

36 Using a small screwdriver, carefully prise the cover(s) off the tailgate grab handle(s) (see illustration). Undo the two grab handle retaining screws now exposed.

37 Starting at the lower corner, pull the trim panel sharply away from the tailgate to release the internal retaining clips (see illustration). When all the clips have been released, remove the panel.

##### Refitting

38 Refitting is a reversal of removal, but ensure that all retaining clips are fully engaged.

#### Headlining

**Note:** Headlining removal requires considerable skill and experience if it is to be carried out without damage, and is therefore best entrusted to a Peugeot/Citroën dealer or bodywork specialist. A general overview of the procedure is given below for those with the expertise to attempt the operation on a DIY basis.

39 The headlining is clipped and glued to the roof, and can be withdrawn only once all fittings such as the grab handles, courtesy lights, sunvisors, sunroof (if fitted), pillar trim panels, and associated additional panels have been removed. The door, tailgate and sunroof aperture weatherstrips will also have to be prised clear and any additional screws and clips removed. Once the

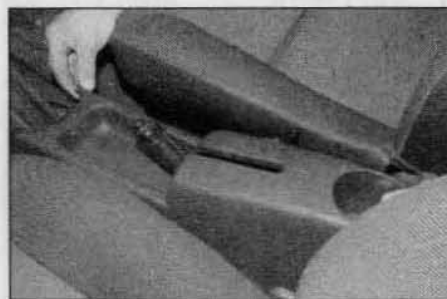

29.4 Lift the console up at the rear, slide it up and over the handbrake lever and remove the rear section from the car

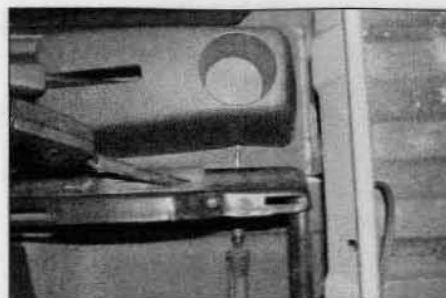

29.2 Undo the screw each side securing the rear console section to the mounting brackets

headlining attachments are released, the adhesive bonding in the centre panels must be broken using a hot air gun and spatula, starting at the front and working rearwards.

40 When refitting, a coat of neoprene adhesive (available from Peugeot/Citroën dealers) must be applied to the centre panels in the locations noted during removal. Position the headlining carefully and refit all components disturbed during removal. Clean the headlining with soap and water or white spirit on completion.

#### 29 Centre console – removal and refitting

##### Removal

1 Tip up the front seats, or slide the front seats forward as far as possible.

2 Undo the screw each side securing the rear console section to the mounting brackets (see illustration).

3 Undo the two screws, one on each side of the handbrake lever (see illustration).

4 Pull the rear console section rearwards, to disengage the front locating pegs. Lift the console up at the rear, slide it up and over the handbrake lever and remove the rear section from the car (see illustration).

5 Twist and remove the gear lever knob off the gear lever (see illustration).

6 Unclip the gear lever gaiter from the front



29.5 Twist and remove the gear lever knob off the gear lever



29.6 Unclip the gear lever gaiter from the front console and slide it up and off the gear lever

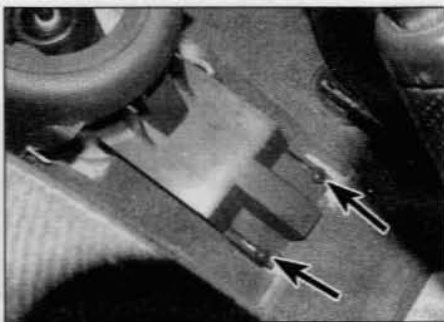

29.7a Undo the two screws (arrowed) at the rear of the console front section ...

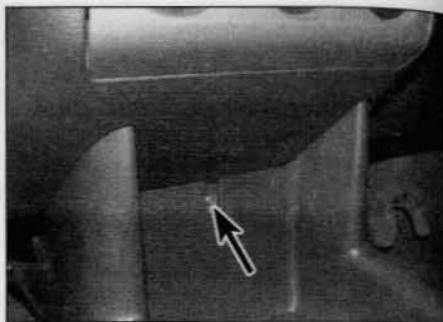

29.7b ... and the central screw (arrowed) below the heater/ventilation controls

console and slide it up and off the gear lever (see illustration).

7 Undo the two screws at the rear of the console front section, and the central screw below the heater/ventilation controls (see illustrations).

8 Undo the retaining screw and detach the side ventilation panel, on each side, from the centre console and fascia (see illustration).

9 Disengage the centre console front section from the fascia, and lift it up at the rear to clear the gear lever (see illustration). Disconnect the wiring connectors and remove the console front section from the car.

**Refitting**

10 Refitting is a reversal of removal.

**30 Facia panel components (pre-September 2002 models) – removal and refitting**



**Steering column shrouds**

**Removal**

1 Undo the four screws securing the lower shroud in position (see illustration).

2 Remove the lower shroud, then lift up and remove the upper shroud from its location (see illustration).

**Refitting**

3 Refitting is a reversal of removal.

**Facia upper panel**

**Removal**

4 Remove the steering column lower and upper shrouds as described previously.

5 Undo the three screws and remove the centre vent unit from the facia (see illustrations).



29.8 Detach the side ventilation panel, on each side, from the centre console and fascia



29.9 Disengage the centre console front section from the fascia, and lift it up at the rear to clear the gear lever

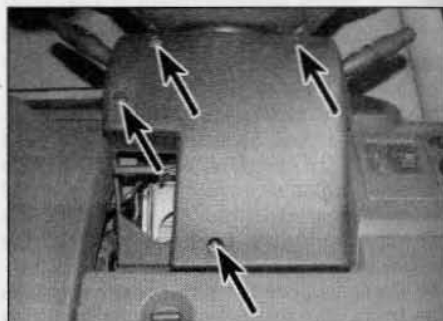

30.1 Undo the four screws (arrowed) securing the steering column lower shroud in position



30.2 Remove the lower shroud, then lift up and remove the upper shroud from its location

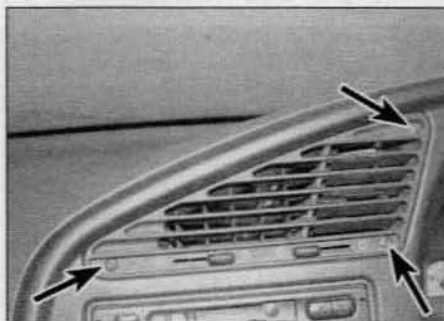

30.5a Undo the three screws (arrowed) ...



30.5b ... and remove the centre vent unit from the facia



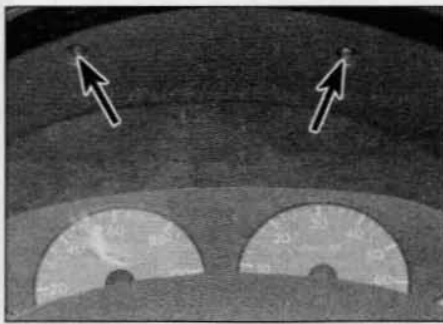

**30.7** Undo the two fascia upper panel retaining screws above the instrument panel (arrowed)

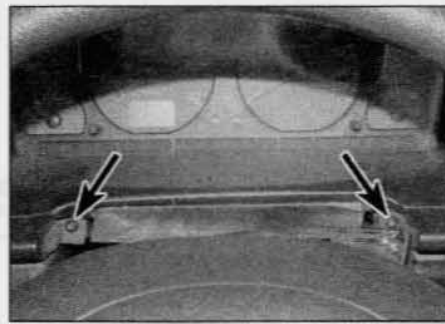

**30.8a** Undo the upper panel retaining screws below the instrument panel (arrowed) . . .

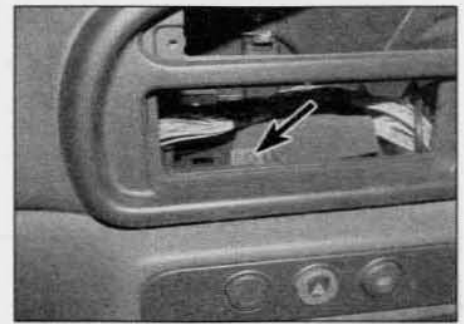

**30.8b** . . . and in the audio unit aperture (arrowed)

**6** Remove the audio unit and mounting frame as described in Chapter 12.

**7** Undo the two fascia upper panel retaining screws located above the instrument panel (see illustration).

**8** Similarly, undo the upper panel retaining screws located below the instrument panel and in the audio unit aperture (see illustrations).

**9** Pull the fascia upper panel from its location to release the retaining clips and remove it from the car (see illustration).

#### Refitting

**10** Refitting is a reversal of removal.

#### Instrument panel

**11** Refer to Chapter 12.

#### Complete fascia assembly

**Note:** This is an involved operation entailing the removal of numerous components and assemblies, and the disconnection of a multitude of wiring connectors. Make notes of the location of all disconnected wiring, or attach labels to the connectors, to avoid confusion when refitting.

#### Removal

**12** Disconnect the battery negative terminal (refer to 'Disconnecting the battery' in the Reference Chapter).

**13** Remove the scuttle grille panel as described in Section 24.

**14** Remove the windscreen wiper motor and linkage as described in Chapter 12.

**15** Working in the scuttle aperture, undo the three nuts securing the fascia to the bulkhead.

**16** Move the front seats as far back as possible. Set the steering wheel in the straight-ahead position, and engage the steering lock.

**17** Remove the steering column shrouds and the fascia upper panel as described previously in this Section.

**18** Remove the centre console as described in Section 29.

**19** Remove the steering wheel as described in Chapter 10.

**20** Remove the following components as described in Chapter 12:

- Instrument panel.
- Audio unit.
- Passenger's airbag.
- Steering column switches.

**21** Remove all the fascia panel switches as described in Chapter 12.

**22** On the passenger's side of the fascia, remove the loudspeaker, then undo the bolt in the loudspeaker aperture.

**23** Remove the front pillar trim panels as described in Section 28.

**24** Undo the two upper retaining screws at each corner of the heater/ventilation control unit.

**25** Using a small screwdriver, release the retaining lug at the lower centre of the control unit and withdraw the unit from the fascia.

**26** Pivot the control unit upwards, as far as clearance will allow, then release the securing

clips and disconnect the control cables from the unit. Note the locations of the cables to ensure correct refitting.

**27** Disconnect the wiring plug from the rear of the control unit, then withdraw the unit.

**28** Remove the stowage box above the heater ventilation/control unit and undo the four centre panel retaining screws.

**29** Remove the ashtray and undo the two screws in the ashtray aperture.

**30** Undo the bolt at the base of the fascia above the centre console location.

**31** Remove the fusebox cover panel and release the fuse/relay box from its fascia attachments.

**32** Undo the retaining bolt and release the bonnet opening handle from its location.

**33** Undo the bolt each side on the outer sides of the fascia.

**34** Disconnect or release all the remaining fascia attachments

**35** With the help of an assistant, lift the fascia from its location and move it rearward. As soon as sufficient clearance exists, disconnect all the fascia wiring connectors, noting their fitted positions. Note the wiring harness routing and release it from the various retaining clips.

**36** Check that everything is disconnected and moved clear, then remove the fascia from the vehicle.

#### Refitting

**37** Refitting is a reversal of removal ensuring that all wiring is correctly reconnected and all mountings securely tightened.



**30.9** Pull the upper panel from its location to release the retaining clips



**31.2** Remove the steering column lower shroud, then lift up and remove the upper shroud

**31** Fascia panel components (post-September 2002 models) – removal and refitting

#### Steering column shrouds

##### Removal

**1** Undo the three screws securing the lower shroud in position.

**2** Remove the lower shroud, then lift up and remove the upper shroud from its location (see illustration).



31.6 Carefully prise the multi-function display surround from the fascia



31.7 Carefully prise the centre switch panel from the fascia to release the upper retaining clips

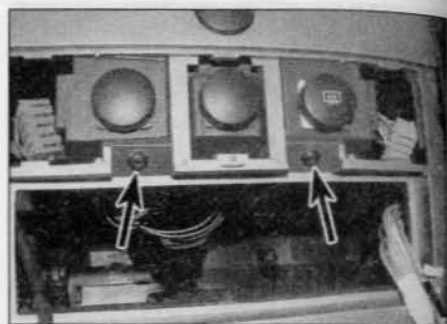

31.9 Undo the two screws (arrowed) above the audio unit aperture

**Refitting**

3 Refitting is a reversal of removal.

**Instrument panel**

4 Refer to Chapter 12.

**Multi-function display**

5 Refer to Chapter 12.

**Facia centre panels**

**Removal**

6 Carefully prise the multi-function display surround from the fascia (see illustration).

7 Carefully prise the centre switch panel from the fascia to release the upper retaining clips (see illustration).

8 Remove the audio unit as described in Chapter 12.

9 Undo the two screws above the audio unit aperture (see illustration).

10 Undo the two screws in the multi-function display aperture (see illustration).

11 Carefully prise the centre panel away from the fascia to release the side retaining clips, and remove the panel from the car (see illustration).

**Refitting**

12 Refitting is a reversal of removal.

**Complete facia assembly**

Note: This is an involved operation entailing

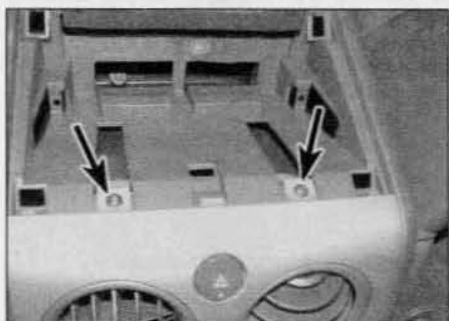

31.10 Undo the two screws (arrowed) in the multi-function display aperture



31.11 Carefully prise the centre panel away from the fascia to release the side retaining clips

the removal of numerous components and assemblies, and the disconnection of a multitude of wiring connectors. Make notes of the location of all disconnected wiring, or attach labels to the connectors, to avoid confusion when refitting.

**Removal**

13 Disconnect the battery negative terminal (refer to 'Disconnecting the battery' in the Reference Chapter).

14 Remove the scuttle grille panel as described in Section 24.

15 Remove the windscreen wiper motor and linkage as described in Chapter 12.

16 Working in the scuttle aperture, undo the three nuts securing the facia to the bulkhead.

17 Move the front seats as far back as possible. Set the steering wheel in the straight-ahead position, and engage the steering lock.

18 Remove the steering column shrouds, and the facia centre panels as described previously in this Section.

19 Remove the front pillar trim panels as described in Section 28.

20 Remove the centre console as described in Section 29.

21 Remove the undercovers from beneath the facia both sides.

22 Remove the steering wheel as described in Chapter 10.

23 Remove the following components as described in Chapter 12:

- a) Instrument panel.
- b) Audio unit.
- c) Passenger's airbag.
- d) Steering column switches.
- e) Multi-function display unit.

24 Remove all the facia panel switches as described in Chapter 12.

25 Remove the tweeter speakers from the top of the facia as described in Chapter 12.

26 Undo the bolt each side on the outer sides of the facia.

27 Undo the two upper retaining screws at each corner of the heater/ventilation control unit.

28 Using a small screwdriver, release the retaining lug at the lower centre of the control unit and withdraw the unit from the facia.

29 Pivot the control unit upwards, as far as clearance will allow, then release the securing clips and disconnect the control cables from the unit. Note the locations of the cables to ensure correct refitting.

30 Disconnect the wiring plug from the rear of the control unit, then withdraw the unit.

31 Undo all the facia retaining screws/bolts.

32 Remove the fusebox cover panel and release the fuse/relay box from its facia attachments.

33 Undo the retaining bolt and release the bonnet opening handle from its location.

34 Disconnect or release all the remaining facia attachments

35 With the help of an assistant, lift the facia from its location and move it rearward. As soon as sufficient clearance exists, disconnect all the facia wiring connectors, noting their fitted positions. Note the wiring harness routing and release it from the various retaining clips.

36 Check that everything is disconnected and moved clear, then remove the facia from the vehicle.

**Refitting**

37 Refitting is a reversal of removal ensuring that all wiring is correctly reconnected and all mountings securely tightened.





# Chapter 12

## Body electrical systems

### Contents

	Section number	Section number	
Airbag system – general information, precautions and system de-activation .....	20	Fuses and relays – general information .....	3
Airbag system components – removal and refitting .....	21	General information .....	1
Audio unit – removal and refitting .....	17	Headlight beam alignment – general information .....	8
Built-in systems interface (BSI) unit/fusebox – general, removal and refitting .....	22	Horn – removal and refitting .....	12
Bulbs (exterior lights) – renewal .....	5	Instrument panel – removal and refitting .....	9
Bulbs (interior lights) – renewal .....	6	Loudspeakers – removal and refitting .....	18
Cigarette lighter/accessory socket – removal and refitting .....	11	Multi-function display unit – removal and refitting .....	10
Electrical fault finding – general information .....	2	Switches – removal and refitting .....	4
Engine immobiliser and anti-theft alarm system – general information .....	19	Tailgate window wiper motor – removal and refitting .....	15
Exterior light units – removal and refitting .....	7	Washer system components – removal and refitting .....	16
		Windscreen wiper motor and linkage – removal and refitting .....	14
		Wiper arm – removal and refitting .....	13

### Degrees of difficulty

<b>Easy</b> , suitable for novice with little experience 	<b>Fairly easy</b> , suitable for beginner with some experience 	<b>Fairly difficult</b> , suitable for competent DIY mechanic 	<b>Difficult</b> , suitable for experienced DIY mechanic 	<b>Very difficult</b> , suitable for expert DIY or professional 
---	--	--	---	--

### Specifications

#### General

System type ..... 12 volt negative earth

#### Bulbs

	Type	Wattage
Direction indicator light .....	Bayonet	21
Direction indicator side repeater .....	Push-fit	5
Front foglight .....	H1	55
Front sidelights .....	Push-fit	5
Headlights .....	H4	60/55
High-level stop-light .....	Push-fit	5
Interior/courtesy lights .....	Push-fit	5
Number plate light .....	Push-fit	5
Rear foglight .....	Bayonet	21
Reversing light .....	Bayonet	21
Stop/tail light .....	Bayonet	21/5

#### Torque wrench setting

	Nm	lbf ft
Airbag control unit retaining nuts .....	8	6

#### 1 General information



**Warning:** Before carrying out any work on the electrical system, read through the precautions given in 'Safety first!' at the beginning of this manual, and in Chapter 5A.

The electrical system is of 12 volt negative earth type. Power for the lights and all electrical accessories is supplied by a lead-acid type battery, which is charged by the alternator.

From the 2001 model year onwards, many of the body electrical systems are controlled by individual electronic control units (ECUs) and these are in turn controlled by a main ECU known as a Built-in Systems Interface (BSI). The various ECUs and the BSI

exchange data with each other via a multiplex network. The multiplex network is a two-wire system linking the BSI with the system ECUs and is termed by Peugeot/Citroën as CAN (controlled area network) and VAN (vehicle area network). Essentially this means that the BSI and the ECUs controlling the 'comfort' systems, safety systems, security systems, and entertainment systems in the vehicle, are all inter-connected via the two networks.

An ECU connected to the multiplex network



only receives some of the data needed for it to operate directly, with the remaining data being supplied by the other ECUs on the network. Because the ECUs share information via the network, several ECUs can control the operation of the same system. Also, one ECU can control several systems in an autonomous manner. The BSI is the manager of this information interchange as well as also being responsible for the control of certain vehicle systems itself. The BSI has a full diagnostic capability whereby any fault in any of the ECUs on the multiplex network can be traced using diagnostic equipment connected to the vehicle diagnostic connector. Should any fault develop with a system on the network, have the self-diagnosis facility interrogated by a Peugeot/Citroën dealer or suitably-equipped specialist.

This Chapter covers repair and service procedures for the various electrical components not associated with the engine. Information on the battery, alternator and starter motor can be found in Chapter 5A.

It should be noted that, prior to working on any component in the electrical system, the battery should first be disconnected, to prevent the possibility of electrical short-circuits (refer to *Disconnecting the battery* in the Reference Chapter).

## 2 Electrical fault finding – general information



**Note:** Refer to the precautions given in 'Safety first!' and in Chapter 5A before starting work. The following tests relate to testing of the main electrical circuits, and should not be used to test delicate electronic circuits (such as anti-lock braking systems), particularly where an electronic control unit (ECU) or multiplexing is used (see Section 1).

### General

1 A typical electrical circuit consists of an electrical component, any switches, relays, motors, fuses, fusible links or circuit breakers related to that component, and the wiring and connectors which link the component to both the battery and the chassis. To help to pinpoint a problem in an electrical circuit, wiring diagrams are included at the end of this Chapter.

2 Before attempting to diagnose an electrical fault, first study the appropriate wiring diagram, to obtain a more complete understanding of the components included in the particular circuit concerned. The possible sources of a fault can be narrowed down by noting whether other components related to the circuit are operating properly. If several components or circuits fail at one time, the problem is likely to be related to a shared fuse or earth connection.

3 Electrical problems usually stem from simple causes, such as loose or corroded

connections, a faulty earth connection, a blown fuse, a melted fusible link, or a faulty relay (refer to Section 3 for details of testing relays). Visually inspect the condition of all fuses, wires and connections in a problem circuit before testing the components. Use the wiring diagrams to determine which terminal connections will need to be checked, in order to pinpoint the trouble-spot.

4 The basic tools required for electrical fault finding include a circuit tester or voltmeter; an ohmmeter (to measure resistance); a battery and set of test leads; and a jumper wire, preferably with a circuit breaker or fuse incorporated, which can be used to bypass suspect wires or electrical components. Before attempting to locate a problem with test instruments, use the wiring diagram to determine where to make the connections.

5 To find the source of an intermittent wiring fault (usually due to a poor or dirty connection, or damaged wiring insulation), a 'wiggle' test can be performed on the wiring. This involves wiggling the wiring by hand, to see if the fault occurs as the wiring is moved. It should be possible to narrow down the source of the fault to a particular section of wiring. This method of testing can be used in conjunction with any of the tests described in the following sub-Sections.

6 Apart from problems due to poor connections, two basic types of fault can occur in an electrical circuit – open-circuit, or short-circuit.

7 Open-circuit faults are caused by a break somewhere in the circuit, which prevents current from flowing. An open-circuit fault will prevent a component from working, but will not cause the relevant circuit fuse to blow.

8 Short-circuit faults are caused by a 'short' somewhere in the circuit, which allows the current flowing in the circuit to 'escape' along an alternative route, usually to earth. Short-circuit faults are normally caused by a breakdown in wiring insulation, which allows a feed wire to touch either another wire, or an earthed component such as the bodyshell. A short-circuit fault will normally cause the relevant circuit fuse to blow. **Note:** On models equipped with a multiplex network (2001 model year onwards) as an aid to economy and to prevent battery discharge, certain functions of the electrical system can only be used for 30 minutes after the engine has been stopped. Bear this in mind when tracing power supply faults on these systems.

#### Functions affected

Windscreens wipers.  
Electric windows.  
Sunroof.  
Courtesy lights.  
Audio equipment.

After this period the BSI (Built-in Systems Interface) cuts the power to these circuits. To restore power, start the engine.

It is also possible for the BSI to turn off certain functions (heater blower, heated rear window) depending on the state of charge of the

battery. When tracing a fault, ensure the battery is in a good state of charge.

### Finding an open-circuit

9 To check for an open-circuit, connect one lead of a voltmeter to either the negative battery terminal or a known good earth.

10 Connect the other lead to a connector in the circuit being tested, preferably nearest to the battery or fuse.

11 Switch on the circuit, bearing in mind that some circuits are live only when the ignition switch is moved to a particular position.

12 If voltage is present (indicated either by the tester bulb lighting or a voltmeter reading, as applicable), this means that the section of the circuit between the relevant connector and the battery is problem-free.

13 Continue to check the remainder of the circuit in the same fashion.

14 When a point is reached at which no voltage is present, the problem must lie between that point and the previous test point with voltage. Most problems can be traced to a broken, corroded or loose connection.

### Finding a short-circuit

15 To check for a short-circuit, first disconnect the load(s) from the circuit (loads are the components which draw current from a circuit, such as bulbs, motors, heating elements, etc).

16 Remove the relevant fuse from the circuit, and connect a circuit tester or voltmeter to the fuse connections.

17 Switch on the circuit, bearing in mind that some circuits are live only when the ignition switch is moved to a particular position.

18 If voltage is present (indicated either by the tester bulb lighting or a voltmeter reading, as applicable), this means that there is a short-circuit.

19 If no voltage is present, but the fuse still blows with the load(s) connected, this indicates an internal fault in the load(s).

### Finding an earth fault

20 The battery negative terminal is connected to 'earth' – the metal of the engine/transmission and the car body – and most systems are wired so that they only receive a positive feed, the current returning via the metal of the car body. This means that the component mounting and the body form part of that circuit. Loose or corroded mountings can therefore cause a range of electrical faults, ranging from total failure of a circuit, to a puzzling partial fault. In particular, lights may shine dimly (especially when another circuit sharing the same earth point is in operation), motors (eg, wiper motors or the radiator cooling fan motor) may run slowly, and the operation of one circuit may have an apparently-unrelated effect on another. Note that on many vehicles, earth straps are used between certain components, such as the engine/transmission and the body, usually where there is no metal-to-metal contact

between components, due to flexible rubber mountings, etc.

**21** To check whether a component is properly earthed, disconnect the battery, and connect one lead of an ohmmeter to a known good earth point. Connect the other lead to the wire or earth connection being tested. The resistance reading should be zero; if not, check the connection as follows.

**22** If an earth connection is thought to be faulty, dismantle the connection, and clean back to bare metal both the bodyshell and the wire terminal or the component earth connection mating surface. Be careful to remove all traces of dirt and corrosion, then use a knife to trim away any paint, so that a clean metal-to-metal joint is made. On reassembly, tighten the joint fasteners securely; if a wire terminal is being refitted, use serrated washers between the terminal and the bodyshell, to ensure a clean and secure connection. When the connection is remade, prevent the onset of corrosion in the future by applying a coat of petroleum jelly or silicone-based grease, or by spraying on (at regular intervals) a proprietary ignition sealer or water-dispersant lubricant.

### 3 Fuses and relays – general information



#### Fuses

**1** Fuses are designed to break a circuit when a predetermined current is reached, in order to protect the components and wiring which could be damaged by excessive current flow. Any excessive current flow will be due to a fault in the circuit, usually a short-circuit (see Section 2).

**2** The majority of fuses are located on the driver's side of the facia, behind a detachable panel. Additional fuses (including the larger, higher-rated maxi-fuses) are located in the fuse/relay box on the left-hand side of the engine compartment (see illustrations).

**3** To gain access to the facia fuses, remove the lower facia panel (turn the retaining knobs 90° and remove the panel). To gain access to the fuses in the engine compartment, simply

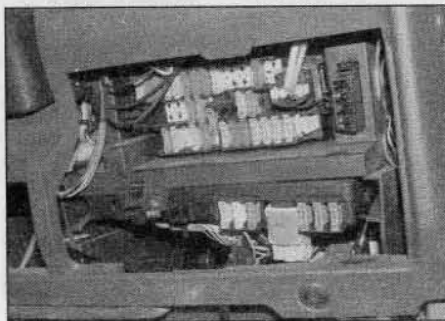

3.2a The majority of fuses are located in the facia fusebox . . .

unclip the cover from the fuse/relay box. The main fuses and relays are in the upper part of the box, with the maxi-fuses located below.

**4** To remove a fuse, first switch off the circuit concerned (or the ignition), then pull the fuse out of its terminals. The wire within the fuse should be visible; if the fuse has blown it will be broken or melted.

**5** Always renew a fuse with one of the correct rating, never use a fuse with a different rating from that specified. The fuse rating is stamped on the top of the fuse, the fuses are also colour-coded as follows. Refer to the wiring diagrams for details of the fuse ratings and the circuits protected.

Colour	Rating
Orange	5A
Red	10A
Blue	15A
Yellow	20A
Clear or white	25A
Green	30A

**6** Never renew a fuse more than once without tracing the source of the trouble. If the new fuse blows immediately, find the cause before renewing it again; a short to earth as a result of faulty insulation is most likely. Where a fuse protects more than one circuit, try to isolate the fault by switching on each circuit in turn (where possible) until the fuse blows again. Always carry a supply of spare fuses of each relevant rating on the vehicle; a spare of each rating should be clipped into the fusebox.

#### Relays

**7** A relay is an electrically-operated switch, which is used for the following reasons:

- A relay can switch a heavy current remotely from the circuit in which the current is flowing, allowing the use of lighter-gauge wiring and switch contacts.
- A relay can receive more than one control input, unlike a mechanical switch.
- A relay can have a timer function – for example, the intermittent wiper relay.

**8** On models so equipped, the majority of relay functions are incorporated into the built-in system interface (BSI) unit (see Section 22). Other relays are located in the fuse/relay box in the engine compartment. Additional relays for the engine electric cooling fans are located in the fan shroud in front of the radiator (refer

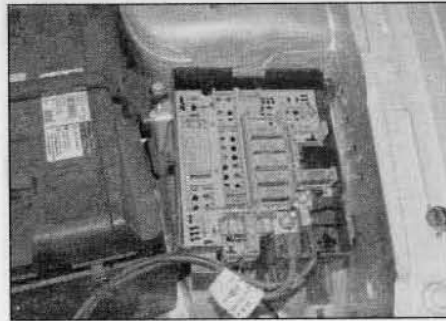

3.2b . . . and in the engine compartment fuse/relay box

to Chapter 3 for details). Other relays may be encountered according to model, equipment specification, and year of manufacture. Refer to the wiring diagrams in Chapter 12 for specific details.

**9** If a circuit or system controlled by a relay develops a fault and the relay is suspect, operate the system. If the relay is functioning, it should be possible to hear it 'click' as it is energised. If this is the case, the fault lies with the components or wiring of the system. If the relay is not being energised, then either the relay is not receiving a main supply or a switching voltage, or the relay itself is faulty. Testing is by the substitution of a known good unit, but be careful – while some relays are identical in appearance and in operation, others look similar but perform different functions.

**10** To remove a relay, first ensure that the relevant circuit is switched off. The relay can then simply be pulled out from the socket, and pushed back into position. Note, however, that with the ever increasing standardisation of vehicle wiring and electrical system components, many relays are now 'welded' in position in their relevant circuit boards for ease of manufacture. This means that the relays are soldered in place and cannot be individually removed. If faulty, the complete circuit board or relay housing must be renewed as an assembly. Changes of this nature occur regularly during the course of vehicle production and are not normally documented by the vehicle manufacturer. Therefore, if a relay appears reluctant to come free from its location, consider that it may be of the welded type and consult a Peugeot/Citroën dealer for the latest information.

### 4 Switches – removal and refitting



**Note:** Disconnect the battery negative terminal before removing any switch, and reconnect the terminal after refitting the switch. Refer to 'Disconnecting the battery' in the Reference Chapter.

#### Ignition switch

**1** Refer to Chapter 10.

#### Steering column switches

##### Pre-September 2002 models

- Remove the steering wheel as described in Chapter 10.
- Remove the steering column lower and upper shrouds as described in Chapter 11.
- On models equipped with an airbag, remove the airbag rotary connector as described in Section 21.
- Disconnect the wiring connectors at the rear of the steering column switches.
- Undo the three screws securing the switch



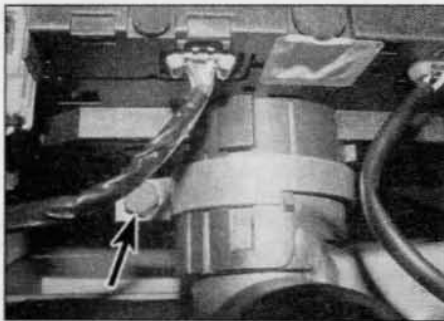

4.11a Slacken the switch assembly retaining clamp (arrowed) . . .

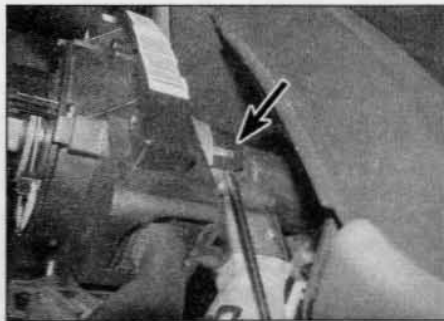

4.11b . . . carefully prise the retaining catches (arrowed) away from the column . . .

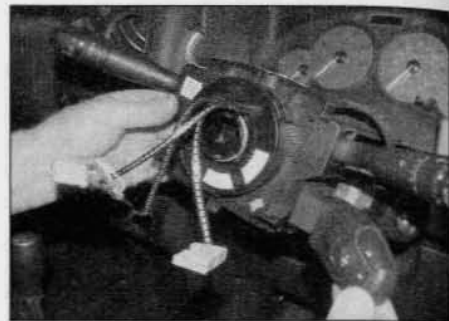

4.11c . . . and lift off the switch assembly - later models



4.11d Turn the unit over and disconnect the wiring connectors - later models

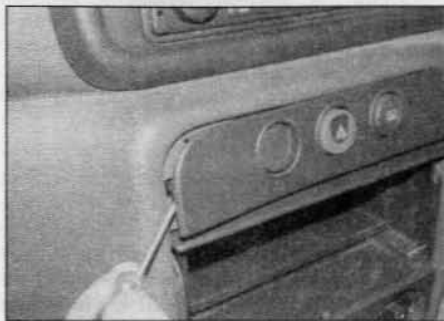

4.14 Carefully prise off the trim panel for access to the switches - early models

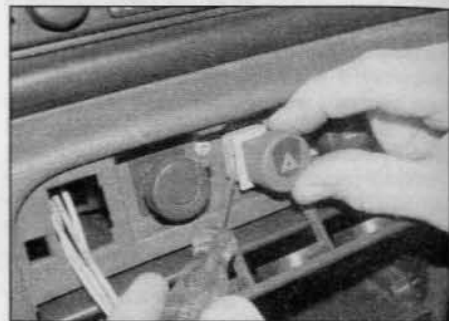

4.15a Depress the retaining lugs on the side of the switch body . . .

housing to the steering column and remove the housing from the column.

7 The relevant switch can now be removed from the housing after unscrewing the two retaining screws.

8 Refitting is a reversal of removal.

**Post-September 2002 models**

9 Remove the steering wheel as described in Chapter 10.

10 Remove the steering column lower and upper shrouds as described in Chapter 11.

11 Slacken the switch assembly retaining clamp, then using a small screwdriver, carefully prise the retaining catches away from the column and lift off the switch assembly. Disconnect the wiring connectors as the assembly is withdrawn (see illustrations).

**Caution: Take great care not damage the switch assembly retaining catches.**

12 If required, the audio unit remote control switch can be unclipped from the main switch assembly.

13 Refitting is a reversal of removal.

**Note:** If a new switch assembly is fitted the unit must be initialised using dedicated test equipment. Entrust this task to a Peugeot/Citroën dealer or suitably-equipped specialist.

**Facia centre-mounted switches**

**Pre-September 2002 models**

14 Using a small screwdriver, carefully prise off the trim panel for access to the switches (see illustration).

15 Depress the retaining lugs on the side of the switch body and withdraw the relevant switch from its location (see illustrations). Disconnect

the wiring connector and remove the switch.

16 Refitting is the reverse of removal.

**Post-September 2002 models**

17 Remove the trim panels in the centre of the facia, for access to the switches, as described in Chapter 11.

18 To remove the lower switches, reach in through the audio unit aperture, or through the opening at the side of the switch, and push the relevant switch out from behind the facia (see illustration). Disconnect the wiring connector and remove the switch.

19 To remove the upper switches, depress the retaining lugs on the top of the switch body and withdraw the switch from the facia (see illustration). Disconnect the wiring connector and remove the switch.

20 Refitting is the reverse of removal.

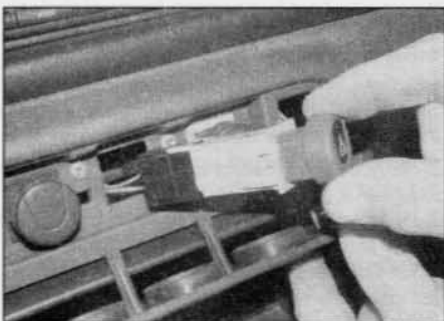

4.15b . . . and withdraw the relevant switch from its location - early models

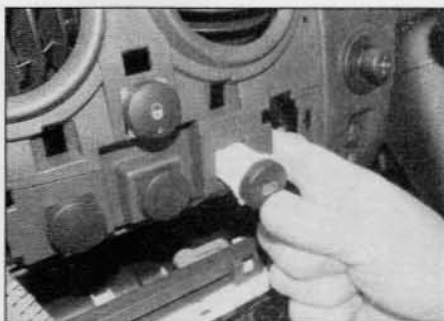

4.18 To remove the lower switches, reach in through the facia aperture and push the switch out from behind - later models

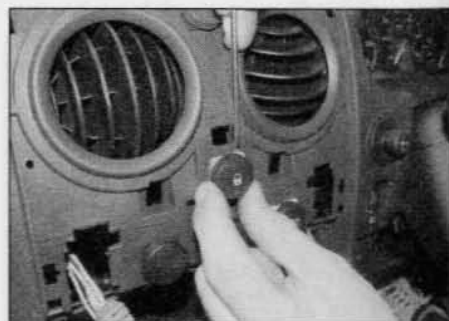

4.19 To remove the upper switches, depress the retaining lugs and withdraw the switch - later models



### Facia side-mounted switches

**21** On pre-September 2002 models, additional switches are located above the fusebox on the driver's side.

**22** Using a small screwdriver, carefully prise out the trim cover around the switch unit. Undo the retaining screw(s) and withdraw the switch unit from the facia. Disconnect the wiring connectors and remove the unit. The switch(es) can then be pushed out from the rear of the panel.

**23** On post-September 2002 models, additional switches are located in the facia adjacent to the heater/ventilation air vents. Using a small screwdriver, carefully prise the relevant switch from its location. Disconnect the wiring connector and remove the switch.

**24** Refitting is the reverse of removal.

### Heating/ventilation control

**25** The switches are an integral part of the heater/ventilation control panel, and cannot be renewed separately. If any switch is faulty, the complete control panel must be renewed – refer to Chapter 3 for details.

### Stop-light switch

**26** Refer to Chapter 9.

### Handbrake warning light switch

**27** Refer to Chapter 9.

### Courtesy light switch

**28** The courtesy light switches are an integral part of the door lock assemblies. Refer to Chapter 11 for door lock removal and refitting details.

## 5 Bulbs (exterior lights) – renewal



### General

**1** Whenever a bulb is renewed, note the following points:

- Remember that, if the light has just been in use, the bulb may be extremely hot.
- Always check the bulb contacts and holder, ensuring that there is clean metal-to-metal contact between the bulb and its live(s) and earth. Clean off any corrosion



**5.8** Disconnect the wiring connector from the headlight bulb – later models



**5.2** Remove the protective rubber cover from the headlight unit – early models

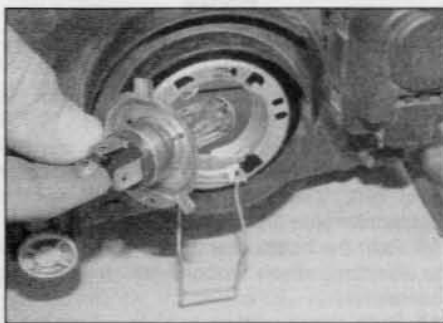

**5.3b** ... and withdraw the headlight bulb – early models

or dirt before fitting a new bulb.

c) Wherever bayonet-type bulbs are fitted (see Specifications), ensure that the live contact(s) bear firmly against the bulb contact.

d) Always ensure that the new bulb is of the correct rating, and that it is completely clean before fitting it; this applies particularly to headlight/foglight bulbs (see below).

### Headlight

#### Pre-September 2002 models

**2** Working in the engine compartment, disconnect the wiring connector from the rear of the headlight bulb, then remove the protective rubber cover from the headlight unit (see illustration).

**3** Release the spring clip and withdraw the bulb (see illustrations).

**4** When handling the new bulb, use a tissue

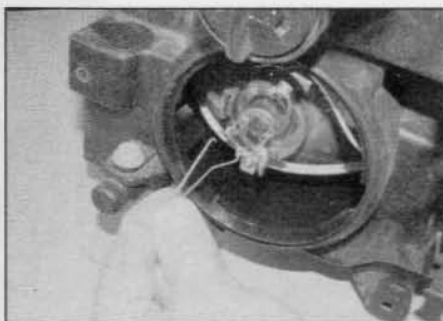

**5.9a** Release the spring clip ...



**5.3a** Release the spring clip ...

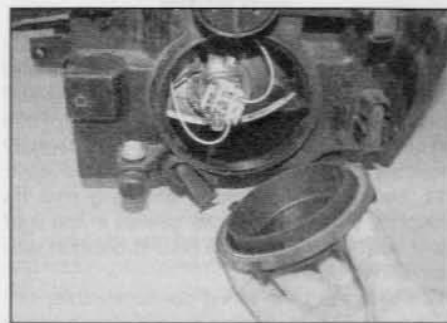

**5.7** Remove the plastic cover from the light unit – later models

or clean cloth to avoid touching the glass with the fingers; moisture and grease from the skin can cause blackening and rapid failure of this type of bulb. If the glass is accidentally touched, wipe it clean using methylated spirit.

**5** Install the new bulb, ensuring that its locating tabs are correctly seated in the light unit cut-outs. Secure the bulb in position with the spring clip.

**6** Refit the protective rubber cover, ensuring that it is correctly seated, then reconnect the wiring connector.

#### Post-September 2002 models

**7** Working in the engine compartment, turn the large plastic cover anti-clockwise and remove it from the rear of the headlight unit (see illustration).

**8** Disconnect the wiring connector from the rear of the headlight bulb (see illustration).

**9** Release the spring clip and withdraw the bulb (see illustrations).

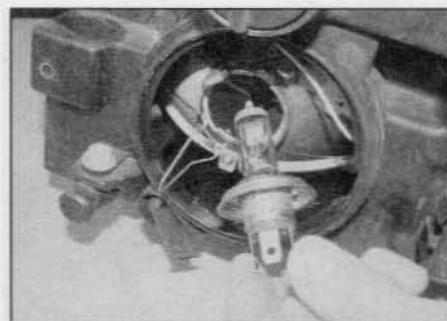

**5.9b** ... and withdraw the headlight bulb – later models

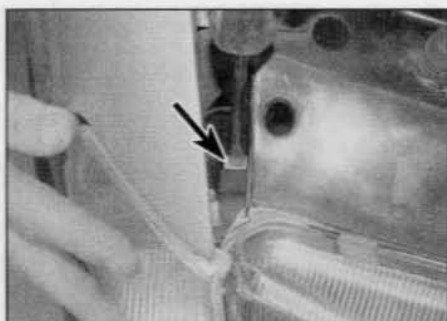

**5.13** Depress the tab (arrowed), and withdraw the direction indicator light unit – early models

**10** When handling the new bulb, use a tissue or clean cloth to avoid touching the glass with the fingers; moisture and grease from the skin can cause blackening and rapid failure of this type of bulb. If the glass is accidentally touched, wipe it clean using methylated spirit.  
**11** Install the new bulb, ensuring that its locating tabs are correctly seated in the light unit cut-outs. Secure the bulb in position with the spring clip.  
**12** Reconnect the wiring connector then refit the plastic cover, turning it clockwise to lock it in place.

**Front sidelight**

**Pre-September 2002 models**

**13** Open the bonnet and depress the tab located at the top of the direction indicator light unit, using a screwdriver (see

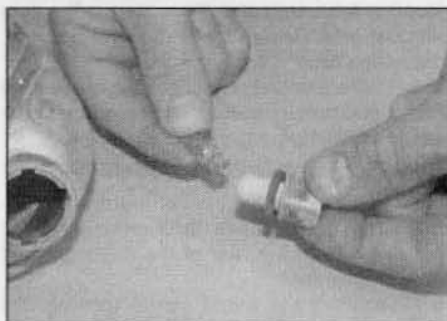

**5.15b** ... the bulb is a push-fit in the bulbholder – early models

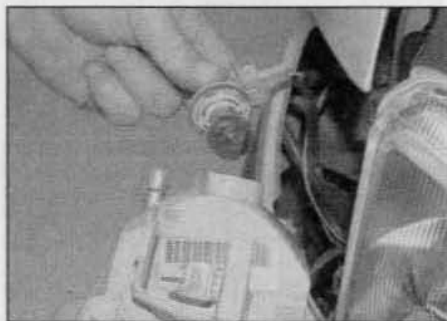

**5.23a** Rotate the direction indicator bulbholder anti-clockwise to release it ...

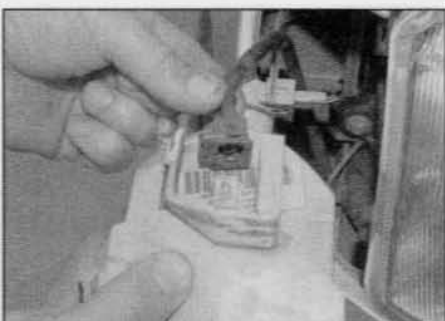

**5.14** Disconnect the wiring connector from the sidelight bulbholder – early models

illustration). Withdraw the direction indicator light unit from its location.

**14** Disconnect the wiring connector from the sidelight bulbholder (see illustration).

**15** Rotate the bulbholder anti-clockwise, and free it from the rear of the direction indicator light unit. The bulb is a push-fit in the bulbholder (see illustrations).

**16** Refit the bulbholder and turn it clockwise to secure, then reconnect the wiring connector.

**17** Refit the direction indicator light unit, ensuring that the upper and lower guides are correctly engaged.

**Post-September 2002 models**

**18** Working in the engine compartment, turn the large plastic cover anti-clockwise and remove it from the rear of the headlight unit (see illustration 5.7). The sidelight bulbholder

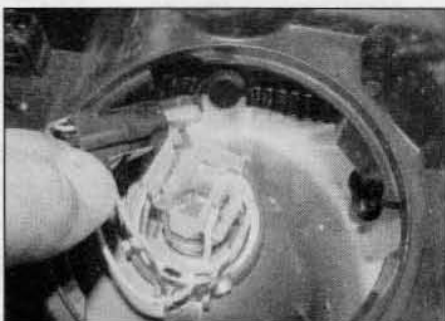

**5.19** Pull the sidelight bulbholder from its location in the headlight unit – later models

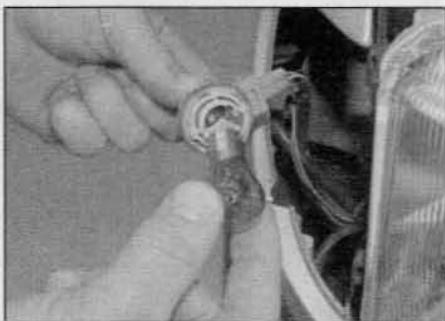

**5.23b** ... the bulb is a bayonet fit in the bulbholder – early models



**5.15a** Rotate the sidelight bulbholder anti-clockwise to release it ...

is located above the headlight bulb. For improved access remove the headlight bulb as described previously.

**19** Pull the sidelight bulbholder from its location in the headlight unit (see illustration). The bulb is a push-fit in the bulbholder.

**20** Refit the bulbholder and, where removed, the headlight bulb.

**21** Refit the plastic cover, turning it clockwise to lock it in place.

**Front direction indicator**

**Pre-September 2002 models**

**22** Open the bonnet and depress the tab located at the top of the direction indicator light unit, using a screwdriver (see illustration 5.13). Withdraw the direction indicator light unit from its location.

**23** Rotate the bulbholder anti-clockwise, and free it from the rear of the light unit. The bulb is a bayonet fit in the bulbholder (see illustrations).

**24** Refit the direction indicator light unit, ensuring that the upper and lower guides are correctly engaged.

**Post-September 2002 models**

**25** Working in the engine compartment, turn the direction indicator bulbholder anti-clockwise and remove it from the rear of the headlight unit. The bulb is a bayonet fit in the bulbholder (see illustrations).

**26** Refitting is a reversal of the removal procedure.



**5.25a** Rotate the direction indicator bulbholder anti-clockwise to release it ...

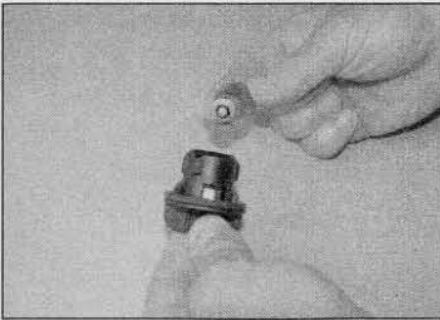

5.25b . . . the bulb is a bayonet fit in the bulbholder – later models

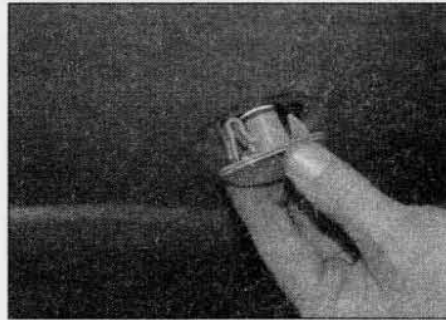

5.27 Push the side repeater light unit forward, then ease it out from the wing



5.28a Rotate the bulbholder anti-clockwise to release it . . .

**Direction indicator side repeater**

27 Push the light unit forward to free its rear retaining clip, then ease it out from the front wing (see illustration).

28 Rotate the bulbholder anti-clockwise and free it from the rear of the light unit. The bulb is a push-fit in the bulbholder (see illustrations).

29 Refitting is a reversal of the removal procedure.

**Front foglight**

30 Undo the retaining screws and partially withdraw the front wheel arch liner for access to the foglight unit.

31 Reach up under the front bumper and disconnect the foglight wiring connector.

32 Turn the bulbholder a quarter turn and withdraw it from the light unit.

33 Release the spring clip, and remove the bulb from the bulbholder.

34 When handling the new bulb, use a tissue or clean cloth to avoid touching the glass with the fingers; moisture and grease from the skin can cause blackening and rapid failure of this type of bulb. If the glass is accidentally touched, wipe it clean using methylated spirit.

35 Install the new bulb, ensuring that its locating tabs are correctly located. Secure the bulb in position with the clip, and refit the bulbholder.

36 Reconnect the foglight wiring connector and refit the wheel arch liner.

**Rear light cluster**

37 Open the tailgate, or the rear door on the relevant side.

38 Undo the plastic retaining nut securing the light unit to the body (see illustration).

39 Push the light unit toward the centre of the car, to release the two outer retaining lugs and gently pull it away from the body (see illustrations).

40 Depress the tabs on the side of the bulbholder and withdraw the bulbholder from the light unit (see illustration).

41 All the bulbs have bayonet fittings. The relevant bulb can be removed by pressing it in and rotating it anti-clockwise (see illustration).

42 Refitting is the reverse of removal, ensuring the light unit and bulbholder seals are in good condition.

**High-level stop-light**

**Models with a tailgate**

43 Open the tailgate and undo the two nuts securing the light unit in position.

44 Withdraw the light unit, then depress the

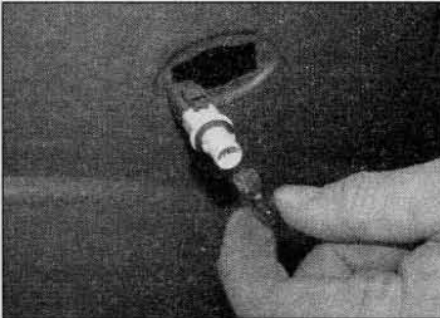

5.28b . . . the bulb is a push-fit in the bulbholder

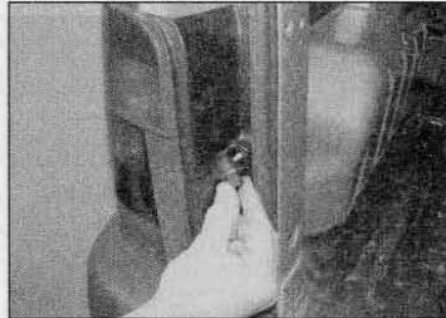

5.38 Undo the plastic retaining nut securing the rear light unit to the body

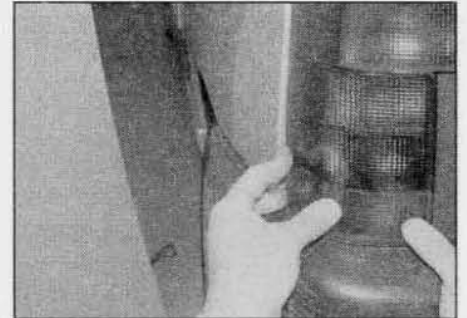

5.39a Push the light unit toward the centre of the car . . .

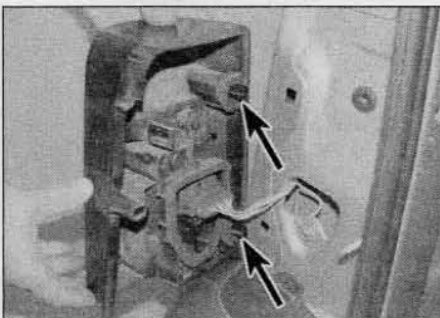

5.39b . . . to release the two outer retaining lugs (arrowed)



5.40 Depress the tabs and withdraw the bulbholder from the light unit . . .



5.41 . . . all the bulbs are a bayonet fit in the bulbholder



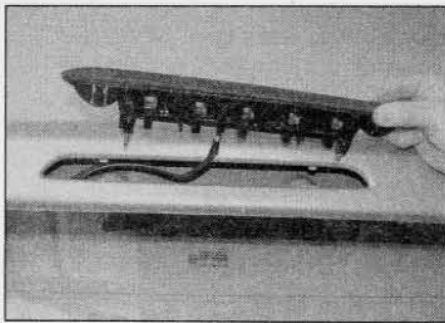

5.44a Withdraw the high-level stop-light unit . . .

two tabs to release the bulbholder (see illustrations).

45 All the bulbs are a push-fit in the bulbholder (see illustration).

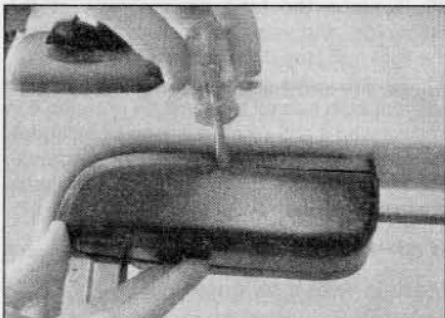

5.47 Prise off the high-level stop-light inner trim panel . . .

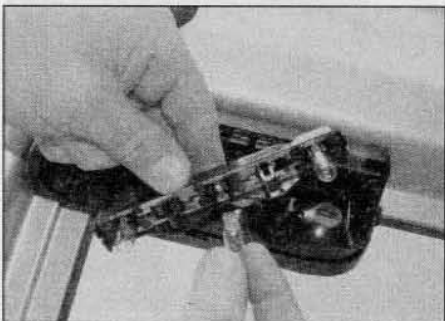

5.49 All the bulbs are a push-fit in the bulbholder - models with hinged rear doors

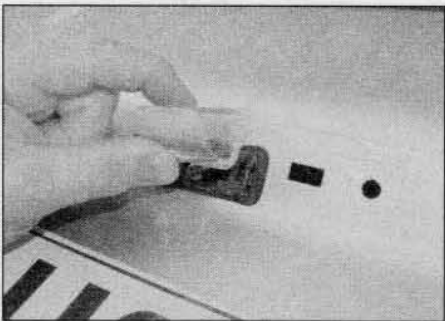

5.52a Unclip the lens from the number plate light unit . . .

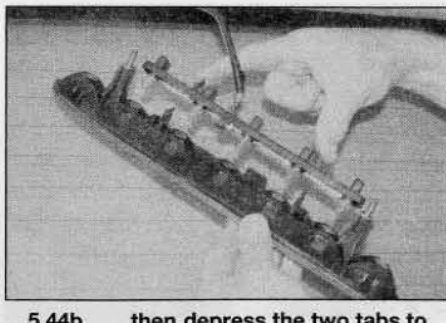

5.44b . . . then depress the two tabs to release the bulbholder - models with a tailgate

46 Refitting is a reversal of the removal procedure.

**Models with hinged rear doors**

47 Open the relevant rear door and carefully

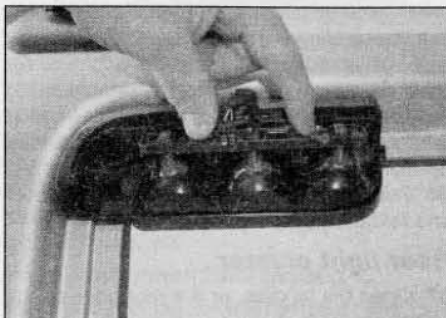

5.48 . . . then depress the two tabs to release the bulbholder - models with hinged rear doors



5.51 Remove the exterior moulding above the number plate lights - models with a tailgate

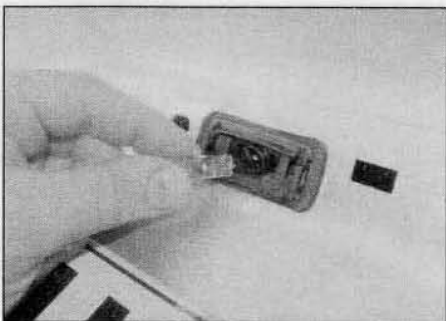

5.52b . . . the bulb is a push-fit in the bulbholder - models with a tailgate

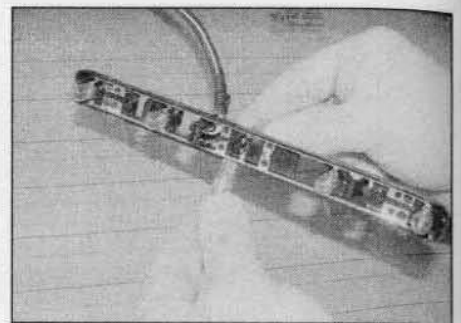

5.45 All the bulbs are a push-fit in the bulbholder - models with a tailgate

prise off the stop light inner trim panel using a screwdriver (see illustration).

48 Depress the two tabs to release the bulbholder (see illustration).

49 All the bulbs are a push-fit in the bulbholder (see illustration).

50 Refitting is a reversal of the removal procedure.

**Number plate light**

**Models with a tailgate**

51 There is very little clearance between the number plate light unit and the plastic exterior moulding above, to allow removal of the light unit lens. In practice it was found necessary to remove the tailgate trim panel (see Chapter 11) then unscrew the three nuts and remove the exterior moulding (see illustration). The nuts are accessible through apertures inside the tailgate.

52 Unclip the lens from the number plate light unit. The bulb is a push-fit in the bulbholder (see illustrations).

53 Clip the lens into position then refit the exterior moulding.

54 Refit the tailgate trim panel (Chapter 11).

**Models with hinged rear doors**

55 There is very little clearance between the number plate light unit and the plastic exterior moulding above, to allow removal of the light unit lens. In practice it was found necessary to first remove the rear door trim panel (see Chapter 11), then proceed as follows.

56 Reach in through the aperture in the rear door and disconnect the number plate light wiring connector (see illustration).

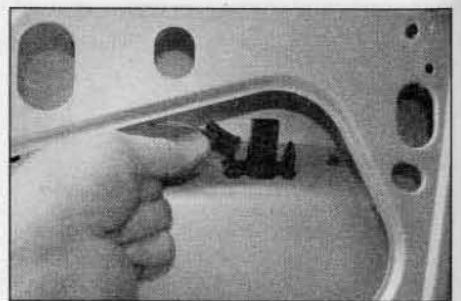

5.56 Disconnect the number plate light wiring connector - models with hinged rear doors

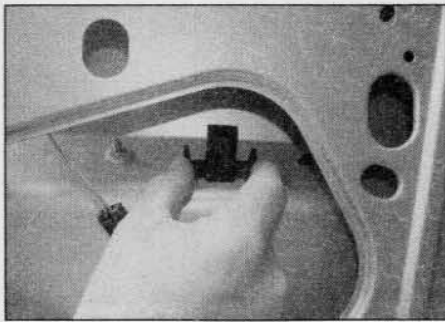

5.57a Depress the tabs . . .

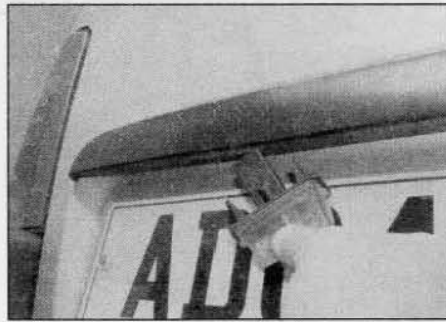

5.57b . . . and push the light unit out of the door – models with hinged rear doors

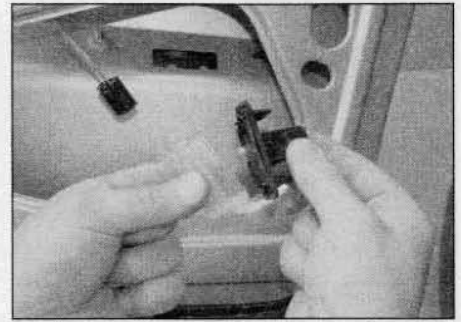

5.58 Unclip the lens from the number plate light unit. The bulb is a push-fit in the bulbholder – models with hinged rear doors

57 Depress the tabs and push the light unit out of the door (see illustrations).

58 Unclip the lens from the number plate light unit (see illustration). The bulb is a push-fit in the bulbholder.

59 Clip the lens into position then refit the light unit to the door. Reconnect the wiring and refit the door trim panel (Chapter 11).

remove them. The capless bulbs simply pull from the bulbholders.

11 Refitting is the reverse of the removal procedure.

**Multi-function display illumination**

12 Remove the multi-function display as described in Section 10.

13 Rotate the bulbholders anti-clockwise and remove them (see illustration). The capless bulbs simply pull from the bulbholder.

renewal of the complete switch assembly (see Section 4).

**7 Exterior light units – removal and refitting**



**6 Bulbs (interior lights) – renewal**



**General**

1 Refer to Section 5, paragraph 1.

**Courtesy lights**

2 Using a small screwdriver, carefully prise the light unit from its location (see illustration).

3 Depress the tabs and withdraw the bulbholder from the light unit. The bulb is a push-fit in the bulbholder (see illustrations).

4 Refitting is the reverse of the removal procedure.

**Instrument panel illumination and warning light bulbs**

**Note:** Renewal of the instrument panel bulbs is only possible on pre-2001 model year vehicles. On later models, the instrument panel and warning lights are illuminated by integral LEDs. It is not possible to renew them independently of the panel.

5 Remove the instrument panel as described in Section 9.

6 Twist the relevant bulbholder anti-clockwise to remove it from the rear of the panel.

7 The bulbs are integral with the bulbholders.

8 On completion, refit the instrument panel with reference to Section 9.

**Heater/ventilation control illumination**

9 Remove the heater/ventilation control unit as described in Chapter 3.

10 Rotate the bulbholders anti-clockwise to

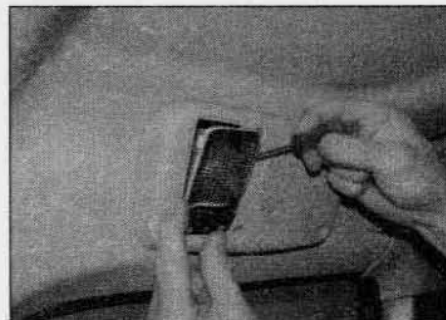

6.2 Carefully prise the courtesy light unit from its location

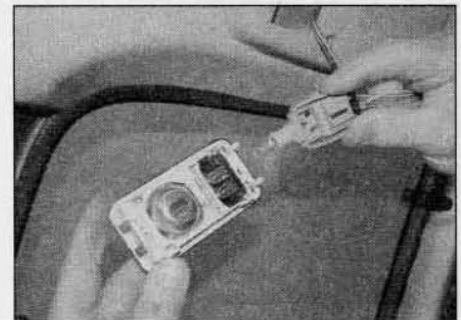

6.3a Depress the tabs and withdraw the bulbholder from the light unit

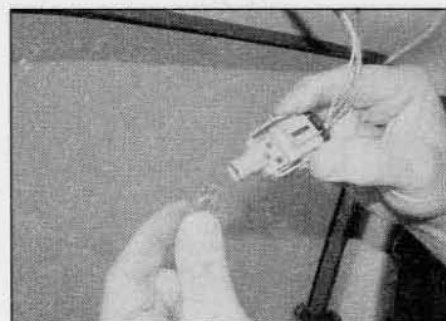

6.3b The bulb is a push-fit in the bulbholder

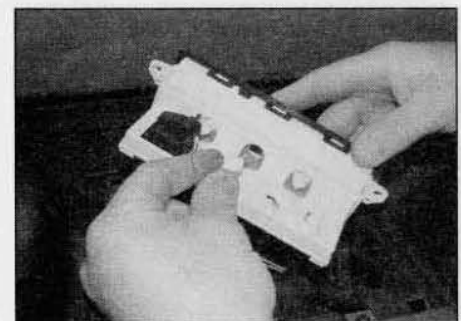

6.13 Remove the multi-function display bulbholders. The bulbs are a push-fit in the bulbholders



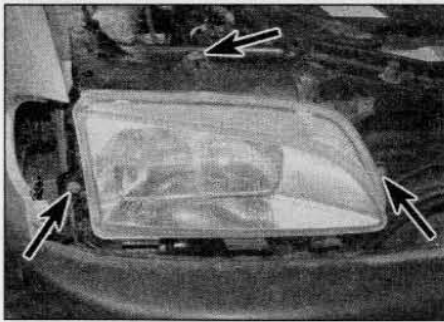

**7.3 Undo the three retaining bolts (arrowed) and withdraw the headlight unit**

the light unit from its location (see illustration).

**4** Disconnect the wiring connectors at the headlight beam adjuster motor and headlight bulb, and remove the light unit from the car (see illustration).

**5** If desired, the electric adjuster motor can be removed from the light unit after lifting the tag and turning the adjuster motor through 90° to release it. Once the motor is released, pull the adjuster rod balljoint from the socket in the rear of the headlight (see illustrations).

**6** To refit the electric adjuster motor, turn the manual height control adjuster using an Allen key to fully extend the adjuster rod. To enable the initial position to be reset after refitting, count the number of turns of the adjuster needed to fully extend the adjuster rod. Engage the balljoint with the socket on the headlight, then fit and secure the adjuster

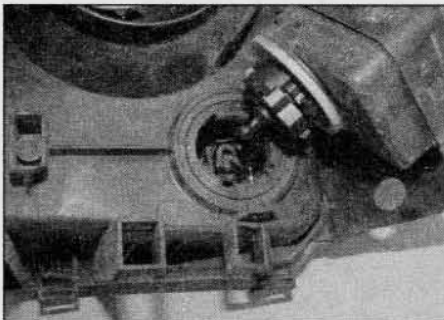

**7.5b ... then pull the adjuster rod balljoint from the headlight socket – early models**

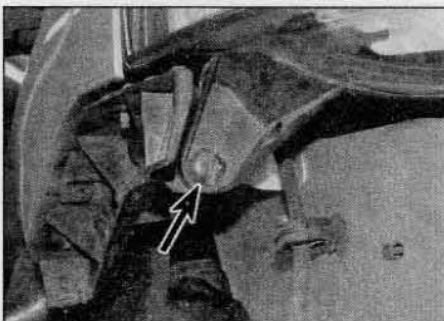

**7.10b ... lower outer (arrowed) ...**

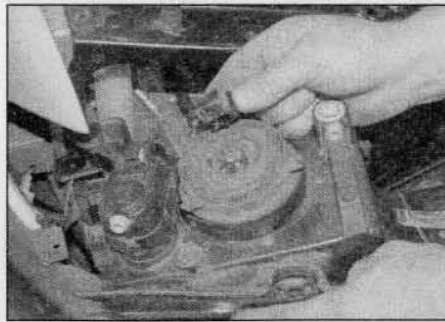

**7.4 Disconnect the wiring connectors and remove the light unit – early models**

motor. Reset the manual height adjuster to the position noted before removal.

**7** Reconnect the wiring connectors and locate the headlight unit in position. Refit the headlight mounting bolts and tighten securely.

**8** The remainder of refitting is a reversal of removal, but on completion have the headlight beam alignment checked at the earliest opportunity.

**Post-September 2002 models**

**9** Remove the front bumper as described in Chapter 11.

**10** Undo the lower inner and outer headlight unit retaining screws and the upper retaining screw (see illustrations).

**11** Using a small screwdriver, lift the upper mounting arm slightly to disengage the retaining lug, and withdraw the headlight from its location (see illustration).

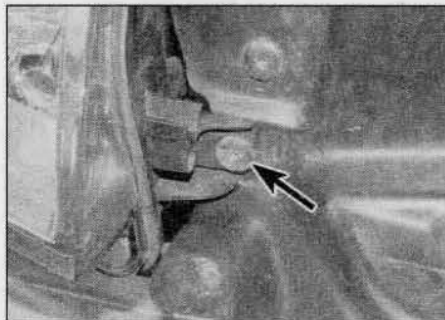

**7.10a Undo the headlight lower inner (arrowed) ...**

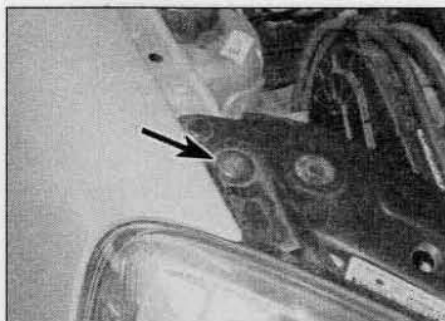

**7.10c ... and upper (arrowed) retaining screws – later models**



**7.5a To remove the headlight adjuster motor, lift the tag and turn the motor through 90° ...**

**12** Disconnect the wiring connector and remove the headlight unit from the car.

**13** Refitting is the reverse of the removal procedure, but on completion have the headlight beam alignment checked at the earliest opportunity.

**Front direction indicator**

**14** The procedure is described as part of the bulb renewal procedure in Section 5.

**Direction indicator side repeater**

**15** The procedure is described as part of the bulb renewal procedure in Section 5.

**Front foglight**

**16** Firmly apply the handbrake, then jack up the front of the car and support it securely on axle stands (see *Jacking and vehicle support*).

**17** Undo the retaining screws and partially withdraw the front wheel arch liner for access to the foglight unit.

**18** Disconnect the foglight wiring connector.

**19** Undo the three foglight retaining bolts and remove the unit from the front bumper.

**20** Refitting is a reversal of removal.

**Rear light unit**

**21** The procedure is described as part of the rear light cluster bulb renewal procedure in Section 5.

**High-level stop-light**

**Models with a tailgate**

**22** The procedure is described as part of the bulb renewal procedure in Section 5.

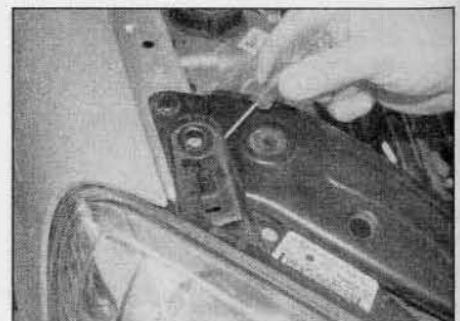

**7.11 Lift the upper mounting arm slightly to disengage the retaining lug, and withdraw the headlight – later models**



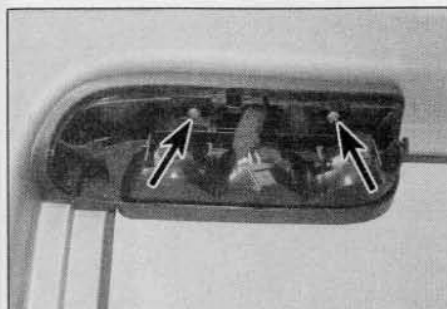

7.24 Undo the two screws (arrowed) and remove the high-level stop-light unit – models with hinged rear doors

**Models with hinged rear doors**

23 Remove the bulbholder as described in the bulb renewal procedure in Section 5.

24 Undo the two screws and remove the light unit from the door (see illustration).

25 Refitting is a reversal of removal.

**Number plate light**

**Models with a tailgate**

26 There is very little clearance between the number plate light unit and the plastic exterior moulding above to allow removal of the light unit lens. In practice it was found necessary to remove the tailgate trim panel (see Chapter 11) then unscrew the three nuts and remove the exterior moulding (see illustration 5.51). The nuts are accessible through apertures inside the tailgate.

27 Reach in through the tailgate aperture,



7.27 Depress the tabs and push out the number plate light unit – models with a tailgate

depress the tabs and push the light unit out of the tailgate (see illustration). Disconnect the wiring connector and remove the light unit.

28 Reconnect the wiring connector and push the unit back into its location.

29 Refit the exterior moulding and the tailgate trim panel.

**Models with hinged rear doors**

30 The procedure is described as part of the bulb renewal procedure in Section 5.

**8 Headlight beam alignment – general information**

1 Accurate adjustment of the headlight beam is only possible using optical beam-setting equipment, and this work should therefore be

carried out by a Peugeot/Citroën dealer or suitably-equipped workshop.

2 Each headlight unit is equipped with a five-position vertical beam adjuster unit – this can be used to adjust the headlight beam to compensate for the relevant load which the vehicle is carrying. The adjuster units are operated by a switch on the facia. The adjusters should be positioned as follows according to the load being carried in the vehicle:

Position 0	Front seats occupied (1 or 2 people)
Position -	Front or rear seats occupied (3 people)
Position 1	Front and rear seats occupied (5 people)
Position 2	Front and rear seats occupied and luggage compartment fully-loaded
Position 3	Driver's seat occupied and luggage compartment fully-loaded

3 Be sure to reset the adjustment if the vehicle load is altered.

**9 Instrument panel – removal and refitting**

555555

**Removal**

**Pre-September 2002 models**

1 Disconnect the battery negative terminal (refer to *Disconnecting the battery* in the Reference Chapter).

2 Remove the steering column lower and upper shrouds as described in Chapter 11.

3 Undo the three screws and remove the centre vent unit from the facia (see illustrations).

4 Remove the audio unit and mounting frame as described in Section 17.

5 Undo the two facia upper panel retaining screws located above the instrument panel (see illustration).

6 Similarly, undo the upper panel retaining screws located below the instrument panel and in the audio unit aperture (see illustrations).

7 Pull the facia upper panel from its location

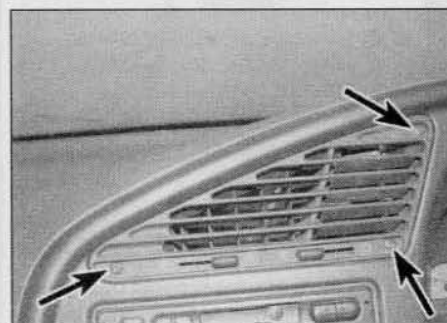

9.3a Undo the three screws (arrowed) . . .



9.3b . . . and remove the centre vent unit from the facia – early models

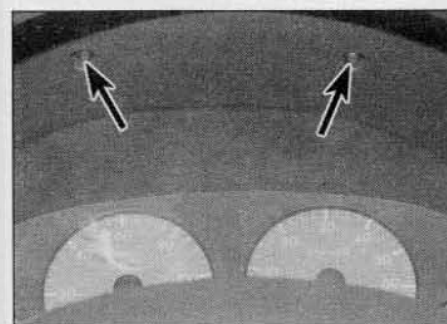

9.5 Undo the two facia upper panel retaining screws above the instrument panel (arrowed) – early models

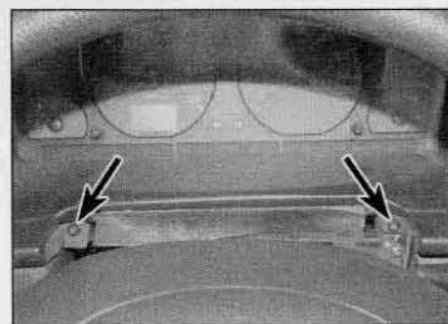

9.6a Undo the upper panel retaining screws below the instrument panel (arrowed) . . .

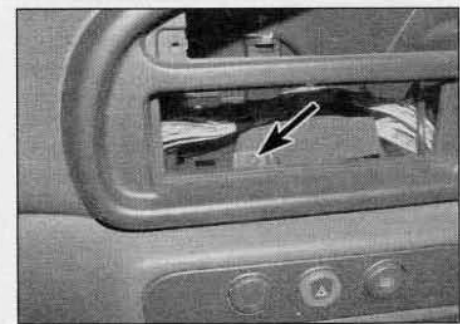

9.6b . . . and in the audio unit aperture (arrowed) – early models

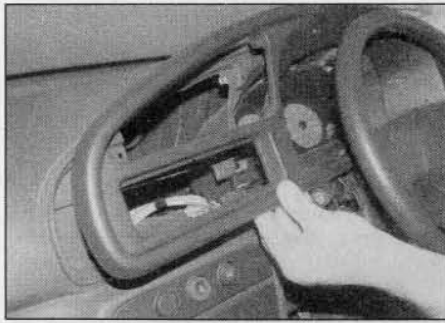

9.7 Pull the upper panel from its location to release the retaining clips – early models

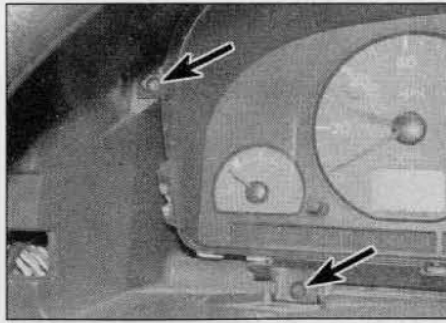

9.8a Undo the two instrument panel retaining screws each side (arrowed) ...

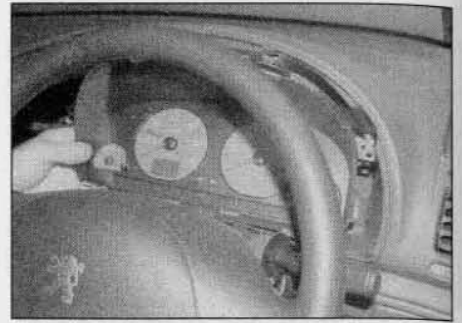

9.8b ... and withdraw the panel from the fascia – early models

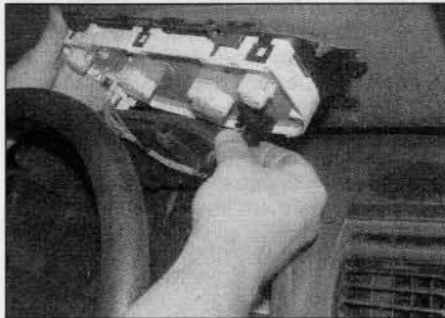

9.9 Turn the instrument panel over and disconnect the wiring connectors – early models



9.10a Pull the instrument panel upper trim upwards and towards the steering wheel to release the retaining clips – later models

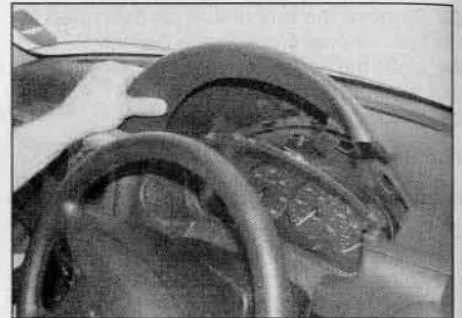

9.10b Disengage the front locating lugs from the fascia and lift off the panel – later models

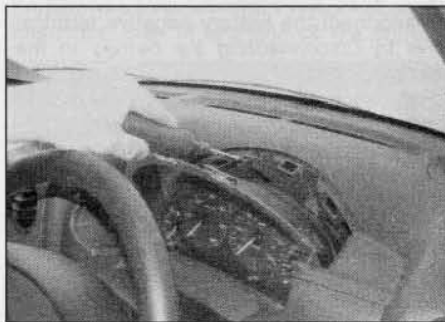

9.11a Undo the retaining screw at the top of the instrument panel ...

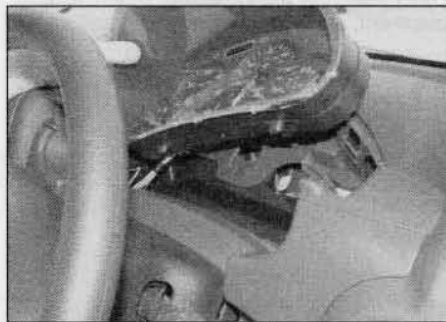

9.11b ... then lift the panel up and withdraw it from its location – later models

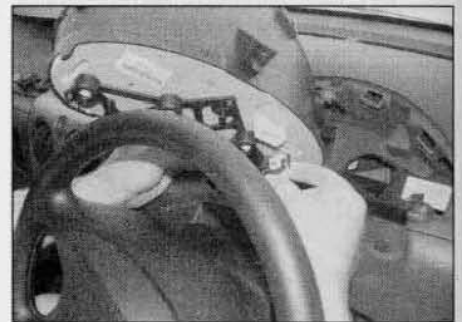

9.12 Turn the instrument panel over and disconnect the wiring connectors – later models

to release the retaining clips and remove it from the car (see illustration).

8 Undo the two instrument panel retaining screws each side and withdraw the panel from the fascia (see illustrations).

9 Turn the panel over and disconnect the wiring connectors at the rear (see illustration).

#### Post-September 2002 models

10 Pull the top of the instrument panel upper trim panel upwards and towards the steering wheel to release the retaining clips. Disengage the front locating lugs from the fascia and lift off the panel (see illustrations).

11 Undo the retaining screw at the top of the instrument panel. Lift the panel up and

withdraw it from its location (see illustrations).

12 Turn the panel over and disconnect the wiring connectors at the rear (see illustration).

#### Refitting

13 Refitting is a reversal of removal.

#### 10 Multi-function display unit – removal and refitting

#### Removal

1 Carefully prise the multi-function display surround from the fascia (see illustration).



10.1 Carefully prise the multi-function display surround from the fascia



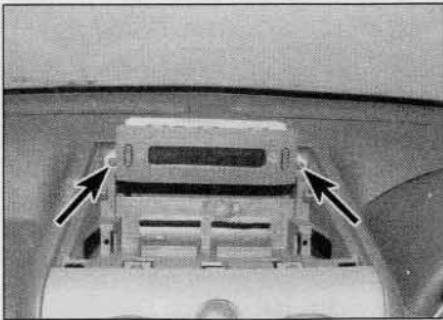

10.2a Undo the two screws (arrowed) . . .

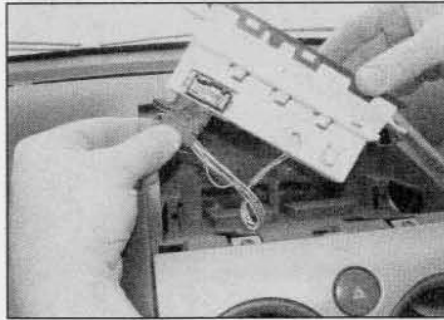

10.2b . . . then withdraw the multi-function display and disconnect the wiring connector

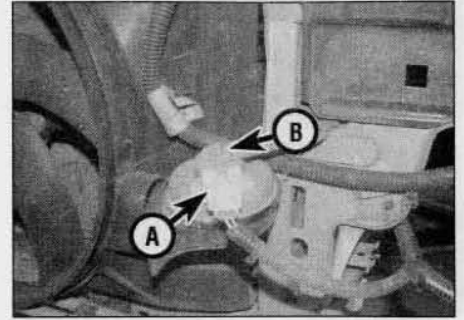

12.3 Horn wiring connector (A) and mounting nut (B)

2 Undo the two screws and withdraw the unit from the fascia. Disconnect the wiring connector and remove the unit from the car (see illustrations).

**Refitting**

3 Refitting is a reversal of removal.

**11 Cigarette lighter/accessory socket – removal and refitting**

**Removal**

- 1 Remove the centre console as described in Chapter 11.
- 2 Carefully release the retaining clips and slide the illumination light assembly off the base of the lighter, taking great care not to break its electrical contacts.
- 3 Pull out the lighter element then release the tangs and push out the metal insert/accessory socket. The plastic outer section can then be removed from the console.

**Refitting**

- 4 Align the plastic outer section tab with the cut-out then insert it into the console.
- 5 Align the bulbholder contact on the metal insert with the holder tangs on the plastic outer then clip the insert into position.
- 6 Slide the illumination light assembly onto the metal insert and clip it securely onto the plastic outer.

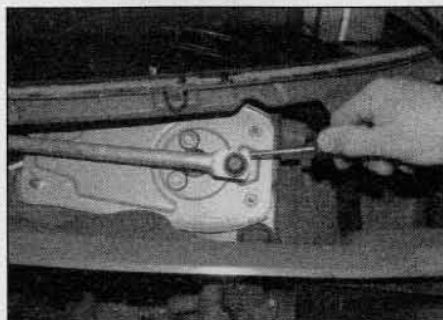

14.2 Prise the windscreen wiper linkage off the balljoint on the motor crank arm

7 Ensure the cigarette lighter is correctly assembled then refit the centre console.

**12 Horn – removal and refitting**

**Removal**

- 1 The horn is located behind the front bumper, on the left-hand side.
- 2 Remove the front bumper as described in Chapter 11.
- 3 Disconnect the wiring connector(s) then undo the mounting nut and remove the horn from the vehicle (see illustration).

**Refitting**

4 Refitting is a reversal of removal.

**13 Wiper arm – removal and refitting**

**Note:** *The wiper arms are a very tight fit on their spindles and it is likely that a puller will be needed to remove them safely and without damage.*

**Removal**

1 Operate the wiper motor, then switch it off so that the wiper arm returns to the at-rest

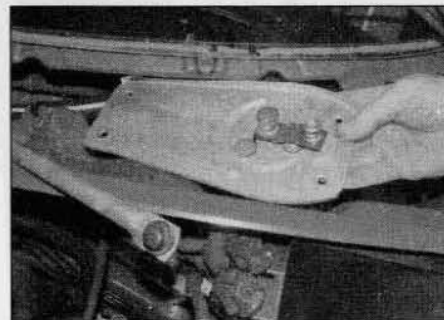

14.3 Undo the three nuts and withdraw the motor mounting plate from the scuttle

position. Stick tape to the screen alongside the wiper blade to ensure correct refitment. There is also an alignment mark provided on the windscreen.

- 2 Remove the wiper arm spindle nut cover then slacken and remove the spindle nut.
- 3 Lift the blade off the glass, and pull the wiper arm off its spindle. If the arm is very tight, free it from the spindle using a suitable puller.

**Refitting**

- 4 Ensure that the wiper arm and spindle splines are clean and dry, then refit the arm to the spindle, aligning the wiper blade with the tape fitted on removal, or the alignment marks provided.
- 5 Refit the spindle nut, tightening it securely, and clip the nut cover (where fitted) back into position.

**14 Windscreen wiper motor and linkage – removal and refitting**

**Removal**

1 Remove the scuttle grille panel as described in Chapter 11.

**Wiper motor**

- 2 Using a suitable screwdriver, prise the linkage off the balljoint on the motor crank arm (see illustration).
- 3 Undo the three nuts and withdraw the motor mounting plate from the scuttle (see illustration). Disconnect the wiring connector and remove the motor and mounting plate.
- 4 To remove the motor from the mounting plate, note the position of the crank arm with the motor in the parked position.
- 5 Undo the retaining nut and remove the crank arm from the motor spindle. Undo the three bolts and separate the motor from the mounting plate.

**Wiper linkage**

- 6 Remove the wiper motor as described previously.
- 7 Undo the bolts/nuts securing the outer



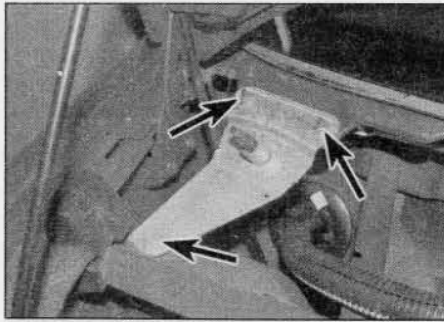

14.7a Undo the bolts/nuts (arrowed) securing the outer spindle assembly . . .

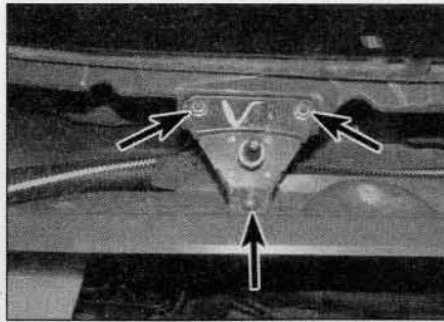

14.7b . . . and centre spindle assembly to the scuttle

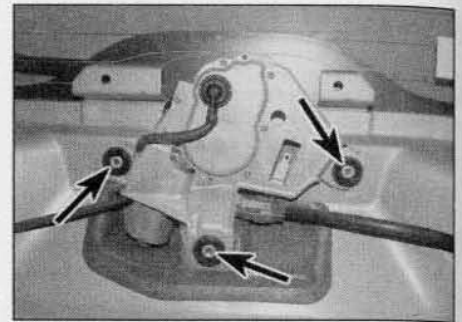

15.4 Tailgate wiper motor attachment rivets (arrowed)

spindle assembly and centre spindle assembly to the scuttle (see illustrations). Manipulate the linkage assembly out from its location.

### Refitting

8 Refitting is a reversal of removal. Ensure that the motor is in the parked position before refitting the crank arm in the position noted during removal.

### 15 Tailgate window wiper motor – removal and refitting

**Note:** On later models, a pop rivet gun and suitable rivets will be required on refitting.

### Removal

- 1 Remove the wiper arm (see Section 13).
- 2 Remove the tailgate trim panel as described in Chapter 11.
- 3 On early models, unscrew the three nuts securing the wiper motor bracket to the tailgate.
- 4 On later models, using a 8 mm drill bit, carefully drill the heads off the pop rivets securing the wiper motor bracket to the tailgate (see illustration).

**Caution:** Take care not to damage the motor and tailgate when drilling out the rivets.

5 With the three nuts or three rivets removed, disconnect the wiring connector and the washer fluid hose and remove the wiper motor

from the tailgate. Take care not to lose the collars from the motor mounting rubbers.

6 Remove the wiper motor sealing grommet from the tailgate glass.

7 Where applicable, recover the remnants of each rivet from the motor bracket/tailgate. Ensure all traces of rivet are removed.

### Refitting

8 Prior to refitting check the sealing grommet and rubber mountings for signs of damage or deterioration and renew as necessary.

9 Ensure the rubber grommet is correctly fitted to the tailgate glass, and the rubber mountings and collars are correctly fitted to the motor mounting bracket.

10 Manoeuvre the wiper motor into position and secure it in position with the nuts or new pop rivets.

11 Reconnect the wiring connector and washer hose to the motor then refit the trim panel to the tailgate. Turn on the ignition, then operate the wiper and allow it to stop in the park position.

12 Refit the wiper arm as described in Section 13.

### 16 Washer system components – removal and refitting

1 The washer reservoir is located behind the right-hand front wing and supplies the windscreen and tailgate washers via single or multiple pumps fitted to the reservoir.

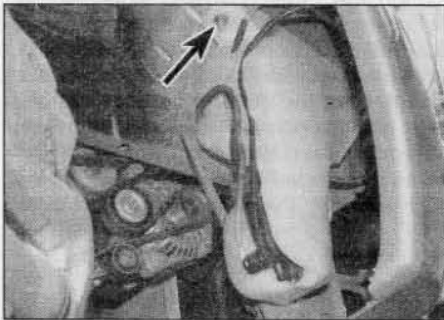

16.6a Washer reservoir upper retaining nut (arrowed) . . .

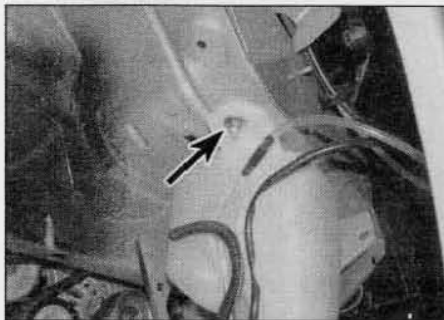

16.6b . . . and lower retaining nut (arrowed)

### Washer fluid reservoir

2 Slacken the right-hand front roadwheel bolts. Jack up the front of the vehicle, and support it securely on axle stands (see *Jacking and vehicle support*). Remove the right-hand roadwheel.

3 From underneath the front wing, undo the screws, prise out the retaining clips, and remove the wheel arch liner from the wing valance.

4 Note the correct fitted location of the washer hoses (if necessary, mark them for identification purposes) then disconnect the hoses from the washer pump(s).

5 Disconnect the wiring connector(s) from the washer pump(s).

6 Slacken and remove the upper and lower retaining nuts, then manoeuvre the reservoir out from underneath the wing (see illustrations).

7 Refitting is the reverse of removal, ensuring that the hoses are securely reconnected. Refill the reservoir and check for leaks.

### Washer pump

8 Proceed as described in paragraphs 2 to 5 and disconnect the hose(s) and wiring connector from the pump.

9 Position a container beneath the reservoir to catch the washer fluid as the pump is removed.

10 Carefully ease the pump out from the reservoir, and recover its sealing grommet. Wash off any spilt fluid with cold water.

11 Refitting is the reverse of removal, using a new sealing grommet if the original shows signs of damage or deterioration. Refill the reservoir and check the pump grommet for leaks on completion.

### Windscreen washer jet

12 Open and support the bonnet

13 Disconnect the washer hose(s) from the relevant jet, then depress the retaining clips and ease the jet out of position.

14 On refitting, clip the jet into the bonnet and reconnect the hose. The aim of the washer jets is not adjustable.

### Tailgate washer jet

15 The tailgate washer jet is integral with the wiper assembly.



**17.3** Insert the removal tools into the holes on the audio unit and withdraw the unit from the fascia



**17.5** On early models, use a small screwdriver to release the mounting frame lugs . . .

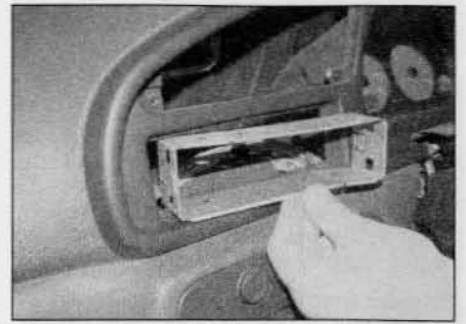

**17.6** . . . then remove the mounting frame from the fascia

**17 Audio unit – removal and refitting**

**Note:** The following procedure is for the range of equipment fitted by Peugeot/Citroën.

**Removal**

- 1 Ensure the audio unit and ignition is switched off.
- 2 The audio units fitted by Peugeot/Citroën have DIN standard fixings. Two special tools, obtainable from most car accessory retailers, are required for removal. Alternatively, suitable tools can be fabricated from 3 mm diameter wire, such as welding rod.
- 3 Insert the tools into the holes on each side of the audio unit and push them in until they snap into place. The audio unit can be slid out of the fascia (see illustration).
- 4 Once the unit has been withdrawn from the fascia, disconnect the wiring connections and aerial lead from the rear, and remove the unit from the vehicle.
- 5 To remove the mounting frame on pre-September 2002 models, use a small screwdriver to release the locating lugs on each side of the unit (see illustration). Note that the frame will be slightly distorted by this procedure, but can be aligned after removal.
- 6 Once the locating lugs have been released, withdraw the frame from the fascia (see illustration).

**Refitting**

- 7 Where applicable, clip the mounting frame back into position.
- 8 Securely reconnect the aerial lead and wiring connectors then slide the unit back into position, taking care not to trap the wiring.

**18 Loudspeakers – removal and refitting**

**Removal**

**Door speakers**

- 1 Turn the speaker grille a quarter turn anti-clockwise and remove it from the door trim panel.

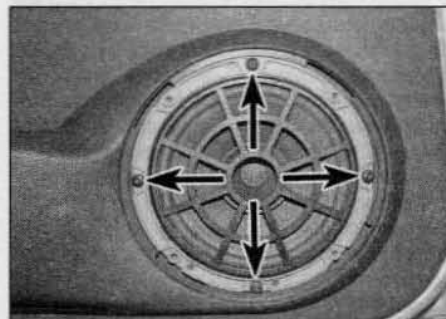

**18.2a** Undo the four screws (arrowed) and withdraw the speaker from the door panel

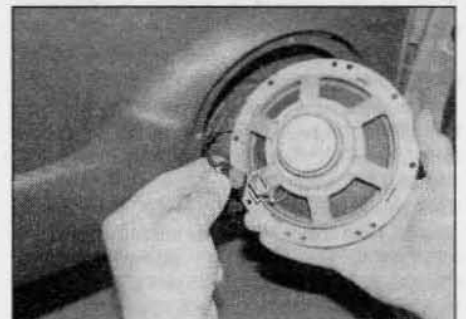

**18.2b** Disconnect the wiring connector and remove the speaker

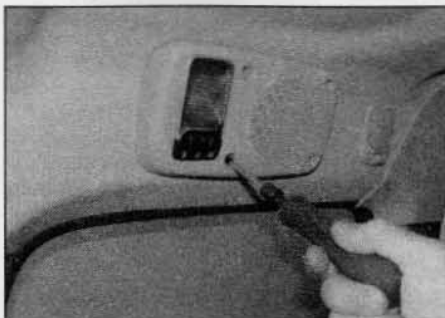

**18.3** Undo the four screws securing the speaker housing in position



**18.4a** Disconnect the speaker wiring . . .

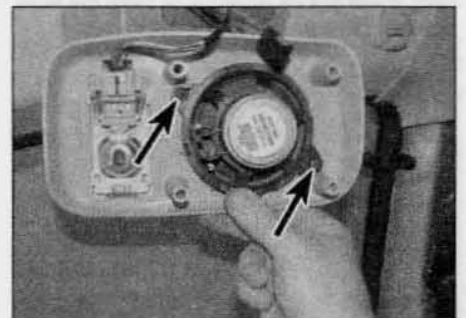

**18.4b** . . . then undo the two screws (arrowed) and remove the speaker from the housing



## 19 Engine immobiliser and anti-theft alarm system – general information

**Note:** This information is applicable only to the later systems fitted by Peugeot/Citroën as standard equipment. Early models utilised a keypad to de-activate the engine immobiliser. At the time of writing, information on the early keypad system was not available.

### Engine immobiliser

**1** An engine immobiliser system is fitted as standard to most models and the system is operated automatically every time the ignition key is inserted/removed.

**2** The immobiliser system ensures the vehicle can only be started using the original Peugeot/Citroën ignition key. The key contains an electronic chip (transponder) which is programmed with a code. When the key is inserted into the ignition switch it uses the current present in the sensor ring (which is fitted to the ignition switch housing) to send a signal to the immobiliser electronic control unit (ECU). On pre-2001 model year vehicles, the control unit is located under the fascia, on the driver's side. On post-2001 model year vehicles, the ECU is incorporated into the built-in systems interface (BSI) unit (see Section 22). The ECU checks this code every time the ignition is switched on. If the key code does not match the ECU code, the ECU will disable the starter, fuel and ignition (as applicable) to prevent the engine being started.

**3** When the vehicle is new, a confidential security card is supplied along with the other vehicle documentation. This card contains the security code which your Peugeot/Citroën dealer requires when carrying out any work on the immobiliser system. Keep this card in a safe place at home; never store it in the vehicle. If the ignition key is lost, a new one can be obtained from a Peugeot/Citroën dealer. Take the confidential security card and all the existing keys along to your Peugeot/Citroën dealer who will supply a new key and reprogramme all the keys with a new security code; this will render the lost key useless.

**Caution:** Without the confidential security card, it will not be possible to have the keys and immobiliser system reprogrammed.



**If you have purchased the vehicle second-hand, as a precaution have all the keys and the immobiliser system reprogrammed with a new security code. This will ensure the keys in your possession are the only ones able to start the vehicle and render all other keys useless.**

**4** Any problems with the engine immobiliser system should be referred to a Peugeot/Citroën dealer.

### Anti-theft alarm system

**5** Most models covered in this manual were equipped with an anti-theft alarm system as standard equipment. The system was available as a option on all other models. The alarm is automatically armed when the deadlocking is set using the remote central locking transmitter and is disarmed when the doors are unlocked using the remote transmitter. The alarm system has switches on the bonnet, tailgate and each of the doors and, on some models, also has ultrasonic sensing, which detects movement inside the vehicle, via sensors mounted on either side of the vehicle interior.

**6** Details of the alarm system operation, according to model, are given in the Owner's handbook. For obvious security reasons, they are not given here.

**7** Should the alarm system become faulty, the vehicle should be taken to a Peugeot/Citroën dealer for examination.

## 20 Airbag system – general information, precautions and system de-activation

### General information

**1** According to model and year of manufacture, a driver's airbag, passenger's airbag, side airbags, and side curtain airbags may be fitted.

**2** The driver's and passenger's airbag system is triggered in the event of a heavy frontal impact above a predetermined force, depending on the point of impact. The airbag is then inflated within milliseconds, and forms a safety cushion between the cabin occupants and the vehicle interior. This prevents contact between the upper body and vehicle interior, and therefore greatly reduces the risk of injury. The airbag then deflates almost immediately. The control unit also operates the front seat belt tensioner mechanisms at the same time (see Chapter 11).

**3** The side airbags are fitted to the seat back of each front seat. Each airbag unit has its own lateral acceleration sensor which is mounted onto the vehicle body. The side airbags are not linked in any way and operate individually.

**4** The curtain airbags are fitted behind the windscreen pillars and headlining on each side of the passenger cabin.

**5** Every time the ignition is switched on, the airbag control unit performs a self-test. The self-test takes approximately six seconds and during this time the warning light in the instrument panel will be illuminated. After the self-test is complete, the warning light will go out (unless the passenger airbag unit has been deactivated – see paragraph 6). If the warning light fails to come on, remains illuminated after the self-test period, or comes on at any time when the vehicle is being

driven, there is a fault in the airbag system. The vehicle should be taken to a Peugeot/Citroën dealer for examination at the earliest possible opportunity.

**6** Vehicles with a passenger airbag are equipped with a disabling switch fitted to the fascia. The switch is operated using the ignition key and switches off the passenger airbag (it is not possible to disable the driver's or side/curtain airbags) to enable a rear-facing child seat to be installed in the passenger seat.

### Precautions



**Warning:** The following precautions must be observed when working on vehicles equipped with an airbag system, to prevent the possibility of personal injury.

#### General precautions

**7** The following precautions must be observed when carrying out work on a vehicle equipped with an airbag:

- Do not disconnect the battery with the engine running.
- Before carrying out any work in the vicinity of the airbag, removal of any of the airbag components, or any welding work on the vehicle, de-activate the system as described in the following sub-Section.
- Do not attempt to test any of the airbag system circuits using test meters or any other test equipment.
- If the airbag warning light comes on, or any fault in the system is suspected, consult a Peugeot/Citroën dealer without delay. Do not attempt to carry out fault diagnosis, or any dismantling of the components.

#### When handling an airbag

- Transport the airbag by itself, bag upward.
- Do not put your arms around the airbag.
- Carry the airbag close to the body, bag outward.
- Do not drop the airbag or expose it to impacts.
- Do not attempt to dismantle the airbag unit.
- Do not connect any form of electrical equipment to any part of the airbag circuit.

#### When storing an airbag unit

- Store the unit in a cupboard with the airbag upward.
- Do not expose the airbag to temperatures above 80°C.
- Do not expose the airbag to flames.
- Do not attempt to dispose of the airbag – consult a Peugeot/Citroën dealer.
- Never refit an airbag which is known to be faulty or damaged.

#### De-activation of airbag system

**8** The system must be de-activated before carrying out any work on the airbag components or surrounding area:



- a) Switch on the ignition and check the operation of the airbag warning light on the instrument panel. The light should illuminate when the ignition is switched on, then extinguish.
- b) Switch off the ignition.
- c) Remove the ignition key.
- d) Switch off all electrical equipment.
- e) Disconnect the battery negative terminal (refer to 'Disconnecting the battery' in the Reference Chapter).
- f) Insulate the battery negative terminal and the end of the battery negative lead to prevent any possibility of contact.
- g) Wait for at least two minutes before carrying out any further work. Wait at least ten minutes if the airbag warning light did not operate correctly.

### Activation of airbag system

9 To activate the system on completion of any work, proceed as follows:

- a) Ensure that there are no occupants in the vehicle, and that there are no loose objects around the vicinity of the steering wheel. Close the vehicle doors and windows.
- b) Ensure that the ignition is switched off then reconnect the battery negative terminal.
- c) Open the driver's door and switch on the ignition, without reaching in front of the steering wheel. Check that the airbag warning light illuminates briefly then extinguishes.
- d) Switch off the ignition.
- e) If the airbag warning light does not operate as described in paragraph c), consult a Peugeot/Citroën dealer before driving the vehicle.

### 21 Airbag system components - removal and refitting



**Warning:** Refer to the precautions given in Section 20 before carrying out the following operations.

#### Driver's airbag - removal

##### Pre-September 2002 models

- 1 De-activate the airbag system as described in Section 20.
- 2 Move the steering wheel as necessary for access to the two airbag unit securing screws. The screws are located at the rear of the steering wheel boss.
- 3 Remove the two airbag unit securing screws.
- 4 Gently pull the airbag unit from the centre of the steering wheel.
- 5 Carefully unclip the wiring connector from the airbag unit (use the fingers only, and pull the connector upward from the airbag unit).
- 6 If the airbag unit is to be stored for any length of time, refer to the storage precautions given in Section 20.

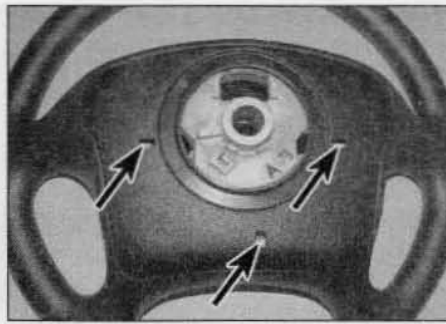

21.8a Insert a screwdriver into the three holes (arrowed) on the underside of the steering wheel . . .

##### Post-September 2002 models

- 7 De-activate the airbag system as described in Section 20.
- 8 Insert a screwdriver into the three holes on the underside of the steering wheel, one at a time, and push the internal retaining spring wire sideways to release the airbag retaining lugs. At the same time pull the airbag unit away from the steering wheel to release it (see illustrations).
- 9 Disconnect the horn push earth connector, then release the locking clip and disconnect the airbag wiring connector (see illustrations). Remove the airbag unit.
- 10 If the airbag unit is to be stored for any length of time, refer to the storage precautions given in Section 20.

#### Driver's airbag - refitting

- 11 Refitting is a reversal of removal, bearing in mind the following points:
  - a) Do not strike the airbag unit, or expose it to impacts during refitting.
  - b) Securely reconnect the wiring connectors then seat the airbag unit in the steering wheel, ensuring the wiring does not become trapped.
  - c) Where the airbag is retained by screws, tighten the screws securely.
  - d) Where the airbag is retained by a spring wire, press it into place until the retaining clips engage.
  - e) On completion of refitting, activate the airbag system as described in Section 20.



21.9a Disconnect the horn push earth connector . . .

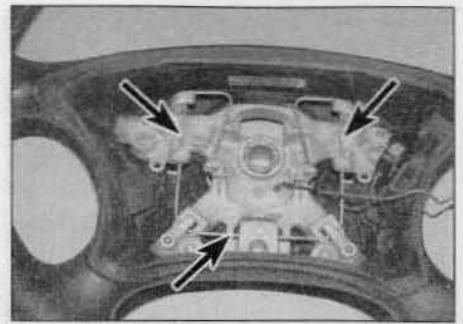

21.8b . . . and push the internal retaining spring wire (arrowed) sideways to release the airbag lugs (shown with airbag removed)

#### Passenger airbag - removal

##### Pre-September 2002 models

- 12 De-activate the airbag system as described in Section 20.
- 13 Remove the glovebox.
- 14 Working in the glovebox aperture, undo the five airbag retaining bolts, located at the base of the airbag unit.
- 15 Release the locking clip, disconnect the airbag wiring connector, then remove the airbag unit from the fascia.
- 16 If the airbag unit is to be stored for any length of time, refer to the storage precautions given in Section 20.

##### Post-September 2002 models

- 17 De-activate the airbag system as described in Section 20.
- 18 Remove the complete fascia assembly as described in Chapter 11.
- 19 Remove the air duct located over the top of the airbag unit.
- 20 Undo the four nuts securing the airbag unit in position. Detach the airbag cover retaining clips around the periphery of the cover, and withdraw the airbag from its location.
- 21 Release the locking clip, disconnect the airbag wiring connector, then remove the airbag unit from the car.
- 22 If the airbag unit is to be stored for any length of time, refer to the storage precautions given in Section 20.

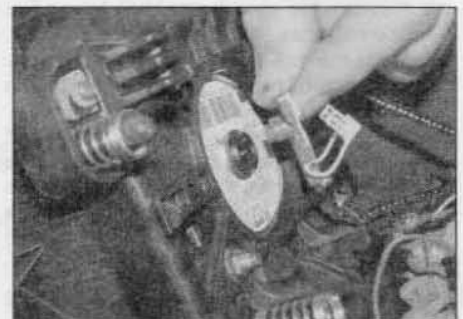

21.9b . . . then release the locking clip and disconnect the airbag wiring connector



**21.34** Release the retaining clip and disconnect the wiring connector (arrowed) from the airbag control unit

### Passenger airbag – refitting

**23** Refitting is a reversal of removal, bearing in mind the following points:

- Do not strike the airbag unit, or expose it to impacts during refitting.
- Securely reconnect the wiring connector then seat the airbag unit in position, ensuring the wiring does not become trapped.
- Securely tighten the airbag retaining nuts/bolts.
- Refit the facia, or glovebox, as applicable, as described in Chapter 11.
- On completion of refitting, activate the airbag system as described in Section 20.

### Side airbag

**24** Removal and refitting of the side airbag units should be entrusted to a Peugeot/Citroën dealer. The seat must be dismantled to enable the airbag unit to be removed/refitted.

### Curtain airbag

**25** Removal and refitting of the curtain airbag units should be entrusted to a Peugeot/Citroën dealer. The headlining must be partially removed to enable the airbag unit to be removed/refitted.

### Rotary connector – removal

#### Pre-September 2002 models

**26** Remove the airbag unit, as described previously in this Section.

**27** Remove the steering wheel as described in Chapter 10.

**28** Remove the steering column lower and upper shrouds as described in Chapter 11.

**29** Trace the rotary connector wiring back to the connectors below the steering column and disconnect the wiring.

**30** Unscrew the three securing screws, and withdraw the rotary connector from the steering column, feeding the wiring harness through the stalk switch bracket. Note the routing of the wiring harness.

#### Post-September 2002 models

**31** The airbag rotary connector is an integral

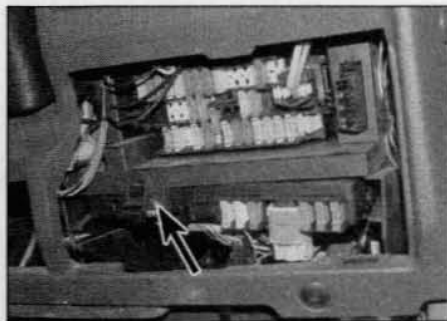

**22.5** On early models, undo the retaining screw (arrowed) then release the clip and pivot the BSI unit downwards

part of the steering column switch assembly, located below the steering wheel. Refer to Section 4 for removal and refitting details.

### Rotary connector – refitting

**32** Refitting is a reversal of removal, bearing in mind the following points on pre-September 2002 models:

- Ensure that the rotary connector is centralised by aligning the marks on the rotary connector body and the rotating centre part prior to refitting. Instructions for centralising the unit are also provided on a label on the face of the unit.
- Ensure that the roadwheels are in the straight-ahead position before refitting the rotary connector and steering wheel.
- Before refitting the steering column shrouds, ensure that the rotary connector wiring harness is correctly routed as noted before removal.
- Refit the steering wheel as described in Chapter 10, and refit the airbag unit as described previously in this Section.

### Airbag control unit

#### Removal

**33** De-activate the airbag system as described in Section 20.

**34** Remove the centre console as described in Chapter 11, then release the retaining clip and disconnect the wiring connector from the airbag control unit (see illustration).

**35** Unscrew the retaining bolts then remove the control unit from the vehicle.

#### Refitting

**36** Refitting is a reversal of removal, bearing in mind the following points:

- Make sure the arrow on the top of the unit is pointing towards the front of the vehicle.
- Refit the control unit retaining bolts and tighten them securely.
- Refit the centre console as described in Chapter 11.
- On completion of refitting, activate the airbag system as described in Section 20.

## 22 Built-in systems interface (BSI) unit/fusebox – general, removal and refitting

### General information

**1** The built-in systems interface (BSI) unit is an electronic control unit which controls a variety of functions, normally controlled by individual control units and relays (refer to Section 1 for additional information). The BSI unit is located in the left-hand side of the facia where it is situated directly beneath the fusebox. The BSI unit controls the following functions (not all functions are fitted to all models).

- Direction indicator/hazard warning lights.
- Windscreen/tailgate wiper motors.
- Rear screen heating element.
- Immobiliser system.
- Anti-theft alarm system.
- Lights-on/ignition key warning buzzer.
- Central locking/deadlocking, including the remote central locking receiver.
- Door open indicator.
- Courtesy light delay timer.

**2** Should any of the above functions become faulty, first check the condition of the fuses. If this fails to locate the problem, take the vehicle to a Peugeot/Citroën dealer for testing.

### Removal

**3** Disconnect the battery negative terminal (refer to *Disconnecting the battery* in the Reference Chapter).

**4** Remove the lower facia panel on the driver's side (turn the retaining knobs 90° and remove the panel).

**5** On early models, undo the retaining screw (where fitted) then release the retaining clip and pivot the BSI unit downwards to free it from the base of the fusebox (see illustration).

**6** On later models, rotate the two white plastic fasteners 90 degrees anti-clockwise, and prise the fusebox outwards slightly. Lower the rear edge of the unit, then lift up the front edge and slide it from place.

**7** On all models, note their fitted positions, then release the retaining clips then disconnect all the wiring connectors and remove the BSI unit from the vehicle. Note that there are several different designs of locking catches for the various connectors. Take your time to study the wiring connectors, and release them without using excessive force as they are easily damaged.

### Refitting

**8** Refitting is the reverse of removal, ensuring the wiring connectors are all securely reconnected. Note that the connector colours are listed adjacent to their respective sockets on the BSI.

**PEUGEOT PARTNER**

**Diagram 1**

**Fuse table**

*Engine fuse box*

Fuses	Rating	Circuit protected
F1	20A	Headlight washer
F2	-	Not used
F3	30A	Engine cooling fan
F4	-	Not used
F5	-	Not used
F6	30A	ABS
F7	-	Not used
F8	-	Not used
F9	10A	Fuel pump
F10	5A	Oxygen sensor
F11	-	Not used
F12	10A	RH main beam
F13	10A	LH main beam
F14	10A	RH dipped beam
F15	10A	LH dipped beam

*Passenger fuse box*

Fuses	Rating	Circuit protected
F1	10A	Radio
F2	5A	Engine control unit, instrument panel
F3	15A	ABS
F4	5A	LH front side light, RH rear side light
F5	-	Not used
F6	10A	Air conditioning
F7	20A	Horn, diagnostic connector
F8	-	Shunt
F9	5A	RH front side light, LH rear side light, number plate lights
F10	20A	Electric windows
F11	20A	Passenger's electric window
F12	20A	Reversing light, engine cooling fan brake lights
F13	5A	Driver's electric window
F14	10A	Central locking
F15	15A	Central locking

Fuses	Rating	Circuit protected
F16	15A	Cigarette lighter
F17	-	Not used
F18	5A	Rear fog light
F19	5A	Interior illumination
F20	25A	Heater blower
F21	5A	Heated rear window, air conditioning
F22	20A	Rear wiper motor
F23	-	Shunt
F24	20A	Front wiper motor
F25	5A	Interior lighting, clock, air conditioning engine control unit
F26	15A	Direction indicators, central locking
F27	30A	Heated rear window
F28	15A	Electric windows, electric mirrors
F29	30A	Air conditioning, heated seats
F30	10A	Direction indicators, instrument panel, interior lights, central locking

Maxi fuses A to H should only be changed by a main dealer

**Key to circuits**

- Diagram 1* Information for wiring diagrams
- Diagram 2* Starting and charging, radio, horn, cigarette lighter, heated rear window, reversing lights
- Diagram 3* Fog, side, number plate, brake, headlights, tail lights, direction indicators and hazard lights
- Diagram 4* ABS, airbag, electric windows, headlight adjustment
- Diagram 5* Wash/wipe, central locking with deadlocking
- Diagram 6* Heater blower, typical engine cooling, air conditioning
- Diagram 7* Instrument panel, interior lights, electric mirrors

**Earth points**

- E1** Battery earth
- E2** RH lower 'A' pillar above E10
- E3** Behind battery
- E4** LH wing
- E5** LH lower 'A' pillar
- E6** LH under tail light
- E7** RH under tail light
- E8** Inside RH front wing
- E9** Behind centre of the dashboard
- E10** RH lower 'A' pillar
- E11** LH lower 'A' pillar above E5
- E12** Engine earth, front of the engine

**Key to symbols**

Bulb		Item no.		Connecting wires	
Switch		Pump/motor		Wire joint	
Fuse/fusible link and current rating		Earth point and location		Wire colour (brown with black tracer)	
Multiple contact switch (ganged)		Solenoid actuator		Screened cable	
Resistor		Diode		Dashed outline denotes part of a larger item, containing in this case an electronic or solid state device.	
Variable resistor		Light emitting diode (LED)		Pin types:	
Heater		Speaker		<b>2</b> - Unspecified colour connector, pin 2.	
				<b>2Mr 1-</b> Brown two pin connector, pin 1.	

**Please Note**

The prime method of wire identification is by using the terminal pin numbers (moulded into each component or connector and shown in the diagrams) together with the number code printed on each wire. To relate each diagram to the vehicle wiring, locate the relevant component or connector illustrated and find the wire(s) connected to the terminal pin(s) as shown in the diagram.

Caution: Whilst a number (indicating the function of that wire) may be printed on each wire, this is not always the case, and in such instances, this is reflected by the absence of such wire numbering on our diagrams. Similarly, numbering of the connector/component terminal pins is not always available from the manufacturers' source information and may also be missing from our diagrams. In these cases, it may be necessary to refer to your local dealer for further information.

Note that the conventional method of using colour coding does not apply - whilst the wires on the vehicle will be coloured, the wire colour has no relevance.



Connector colours

Nr	Black	Or	Orange
Be	Blue	Rg	Red
Mr	Brown	Ba	White
Gr	Grey	Jn	Yellow
Ve	Green		

Key to items

1	Battery	7	Engine running relay	13	Horn switch
2	Ignition switch	8	Diagnostic connector	14	Horn
3	Engine fuse box	9	Radio	15	Cigarette lighter
4	Passenger fuse box	10	Aerial	16	Ashtray illumination
5	Alternator	11	RH speaker	17	Heated rear window relay
6	Starter motor	12	LH speaker	18	Heated rear window switch

Diagram 2

MTS  
H33268

Starting and charging

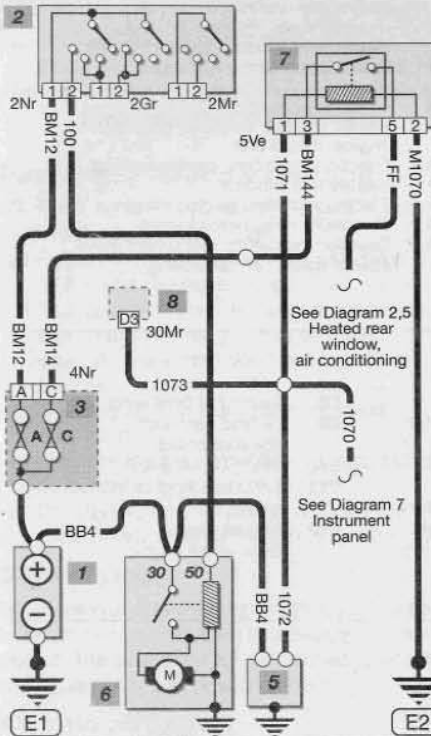

Radio

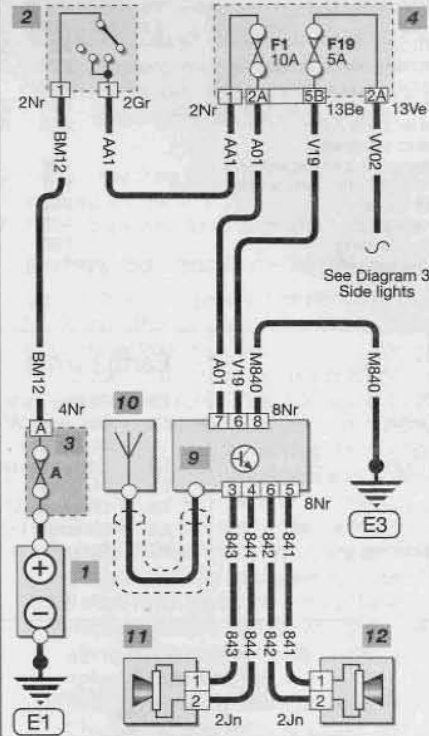

Cigarette lighter

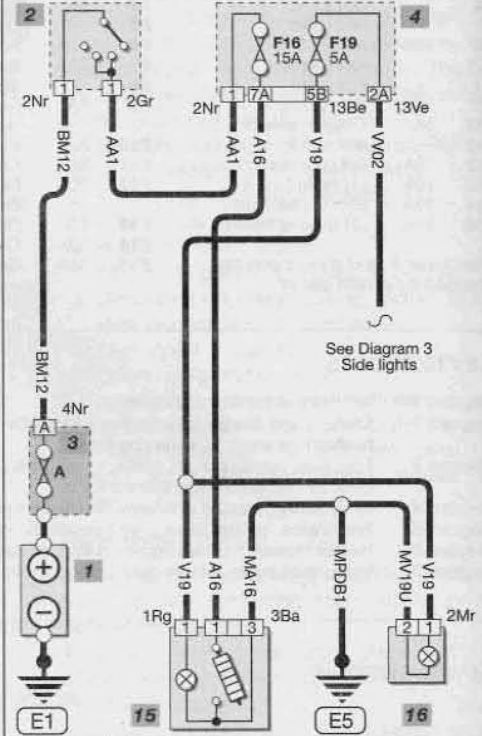

Horn

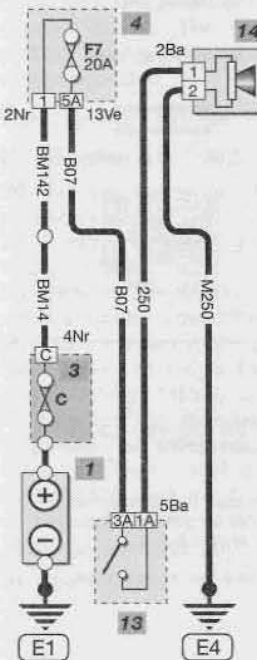

Heated rear window

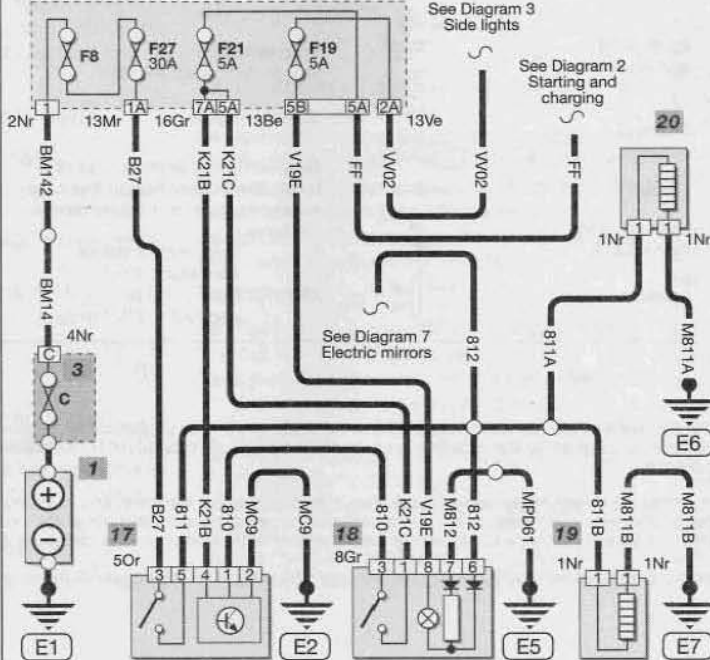

Reversing lights

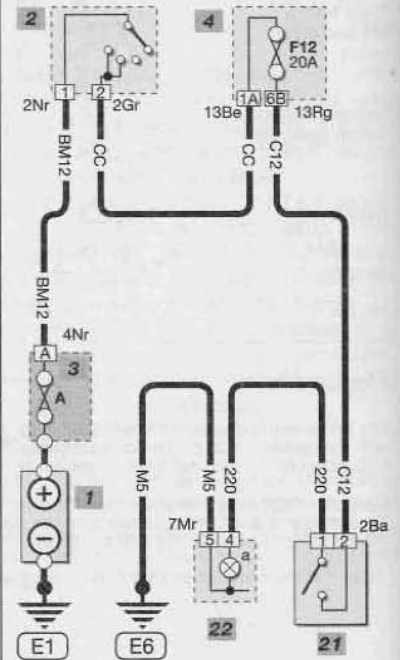

Connector colours

Nr	Black	Or	Orange
Be	Blue	Rg	Red
Mr	Brown	Ba	White
Gr	Grey	Jn	Yellow
Ve	Green		

Key to items

- |    |                     |    |                           |
|----|---------------------|----|---------------------------|
| 1  | Battery             | 23 | RH tail light             |
| 2  | Ignition switch     | a) | fog light                 |
| 3  | Engine fuse box     | b) | brake light               |
| 4  | Passenger fuse box  | c) | tail light                |
| 22 | LH tail light       | d) | direction indicator       |
| b) | brake light         | 24 | Steering wheel switches   |
| c) | tail light          | 25 | Brake light switch        |
| d) | direction indicator | 26 | LH additional brake light |

- |    |                           |
|----|---------------------------|
| 27 | RH additional brake light |
| 28 | LH number plate light     |
| 29 | RH number plate light     |
| 30 | LH front side light       |
| 31 | RH front side light       |
| 32 | LH headlight              |
| a) | main beam                 |
| b) | dipped beam               |

- |         |                          |
|---------|--------------------------|
| 33      | RH headlight             |
| (as 32) |                          |
| 34      | LH front indicator light |
| 35      | LH side repeater         |
| 36      | RH front indicator light |
| 37      | RH side repeater         |
| 38      | Hazard light switch      |
| 39      | Flasher unit             |

Diagram 3

MTS  
H33289

Fog light

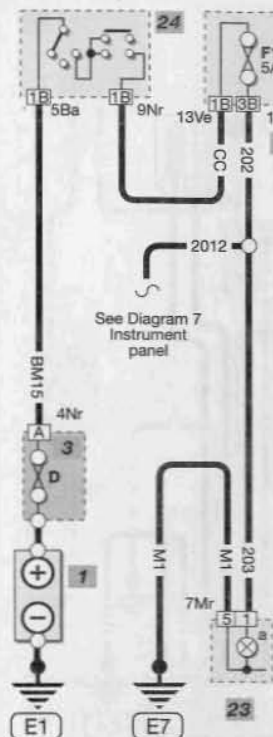

Brake lights

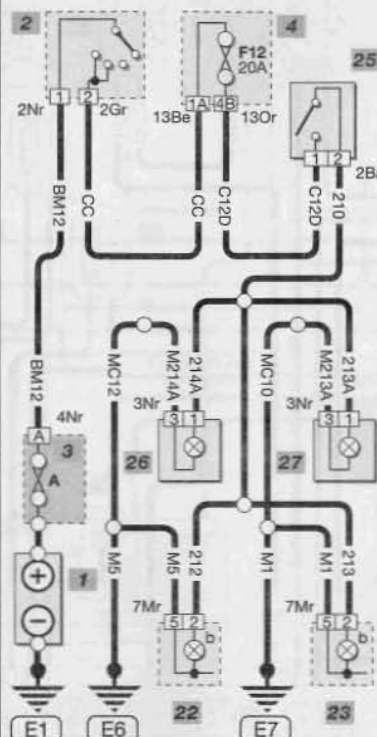

Side, tail and number plate lights

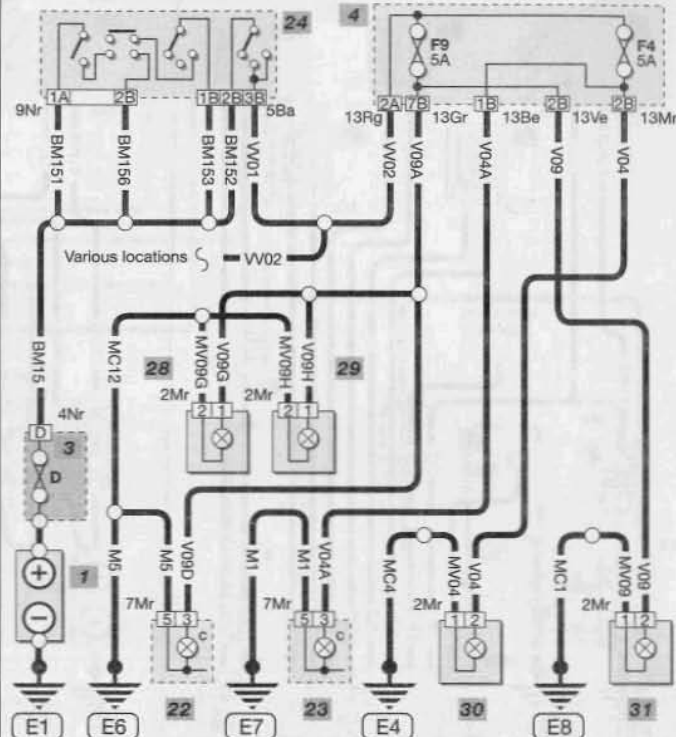

Headlights

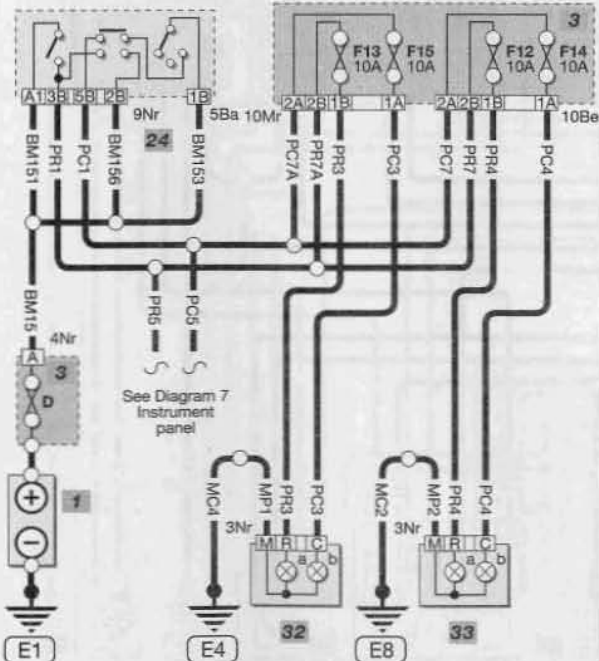

Direction indicators and hazard lights

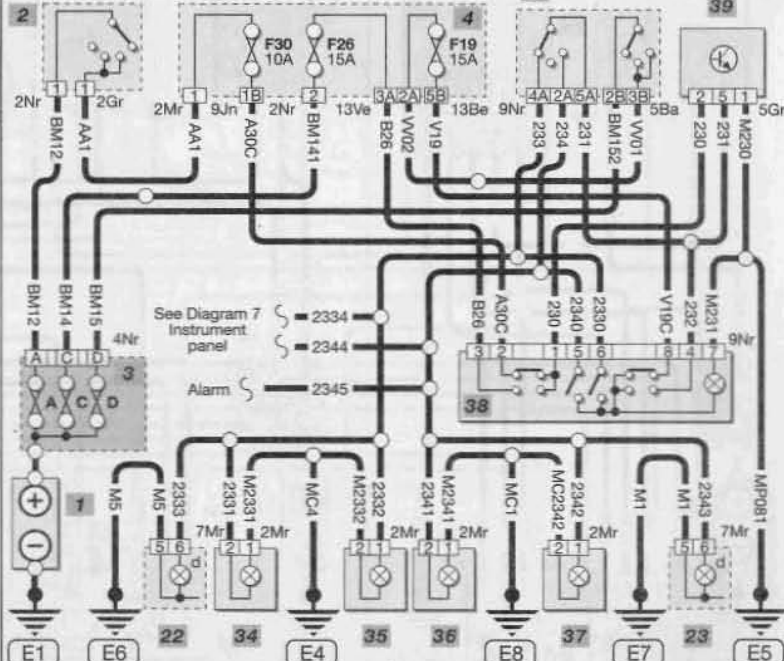

Connector colours

Nr	Black	Or	Orange
Be	Blue	Rg	Red
Mr	Brown	Ba	White
Gr	Grey	Jn	Yellow
Ve	Green		

Key to items

- |    |                                   |    |                                |    |                               |
|----|-----------------------------------|----|--------------------------------|----|-------------------------------|
| 1  | Battery                           | 42 | Driver's seatbelt pretensioner | 51 | Headlight adjustment switch   |
| 2  | Ignition switch                   | 43 | Passenger's airbag             | 52 | LH headlight adjustment motor |
| 3  | Engine fuse box                   | 44 | Driver's airbag                | 53 | RH headlight adjustment motor |
| 4  | Passenger fuse box                | 45 | Clock spring                   | 54 | Electric window relay         |
| 8  | Diagnostic connector              | 46 | ABS module                     | 55 | LH window switch              |
| 24 | Steering wheel switches           | 47 | LH front wheel sensor          | 56 | RH window switch              |
| 25 | Brake light switch                | 48 | RH front wheel sensor          | 57 | Electric window module        |
| 40 | Airbag module                     | 49 | LH rear wheel sensor           | 58 | LH window motor               |
| 41 | Passenger's seatbelt pretensioner | 50 | RH rear wheel sensor           | 59 | RH window motor               |

Diagram 4

MTS  
H33270

Airbag

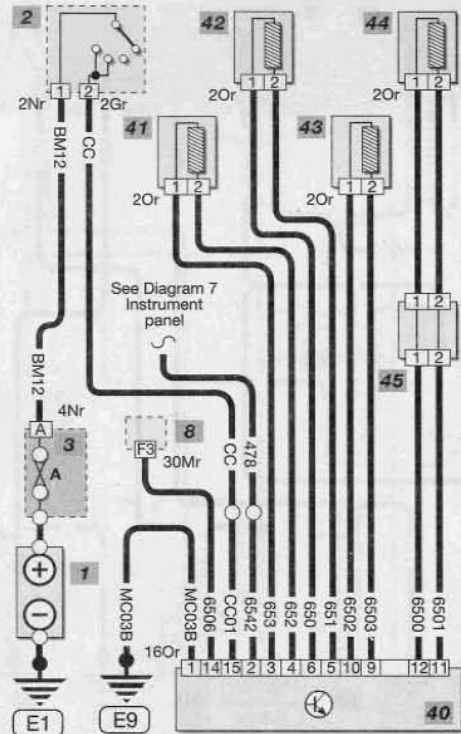

ABS

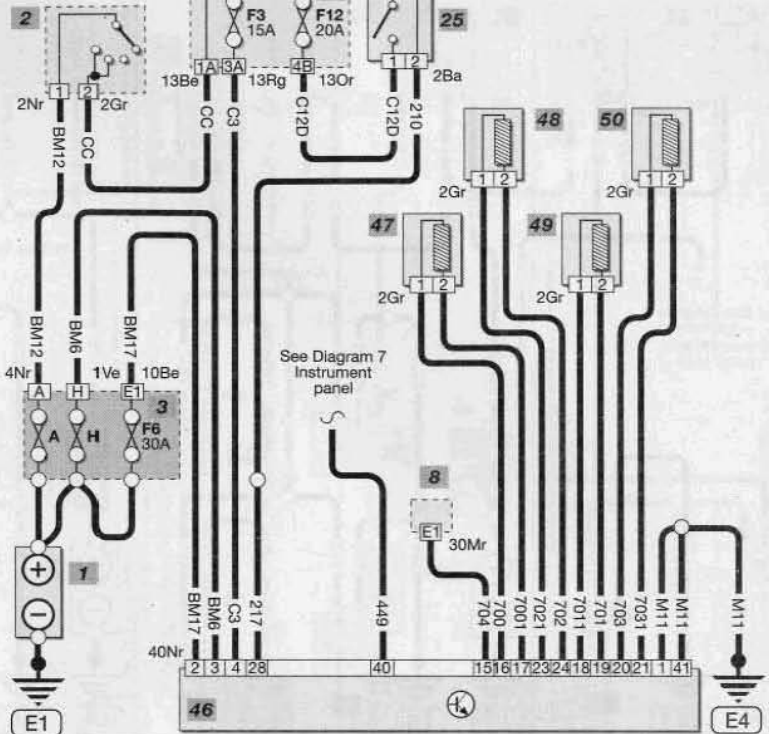

Headlight adjustment

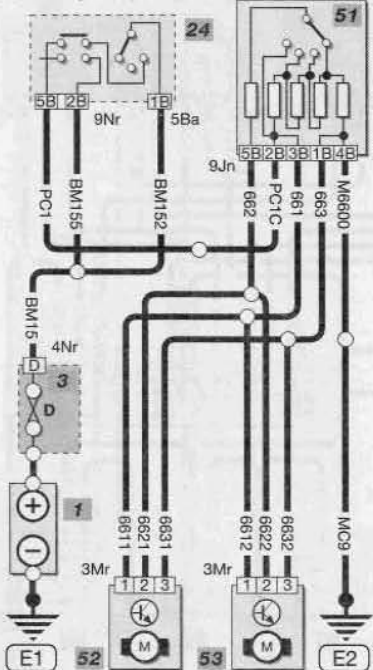

Electric windows

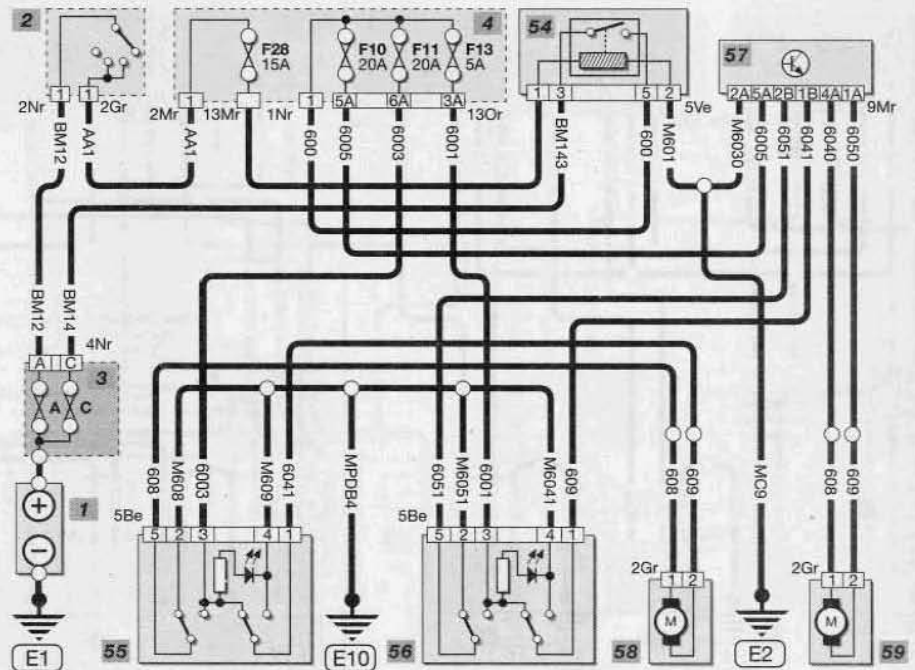



Diagram 5

Connector colours

Nr	Black	Or	Orange
Be	Blue	Rg	Red
Mr	Brown	Ba	White
Gr	Grey	Jn	Yellow
Ve	Green		

Key to items

- |                        |                                |                             |
|------------------------|--------------------------------|-----------------------------|
| 1 Battery              | 62 Wiper motor                 | 69 Driver's door lock motor |
| 2 Ignition switch      | 63 LH rear wiper motor         | 70 RH rear door switch      |
| 3 Engine fuse box      | 64 RH rear wiper motor         | 71 Passenger's door switch  |
| 4 Passenger fuse box   | 65 Windscreen wiper relay      | 72 Driver's door switch     |
| 8 Diagnostic connector | 66 Rear wiper relay            | 73 Key signal receiver      |
| 60 Wash/wipe switch    | 67 Central locking unit        | 74 RH rear door lock motor  |
| 61 Washer pump         | 68 Passenger's door lock motor | 75 LH rear door lock motor  |

MTS  
H33271

Wash/wipe

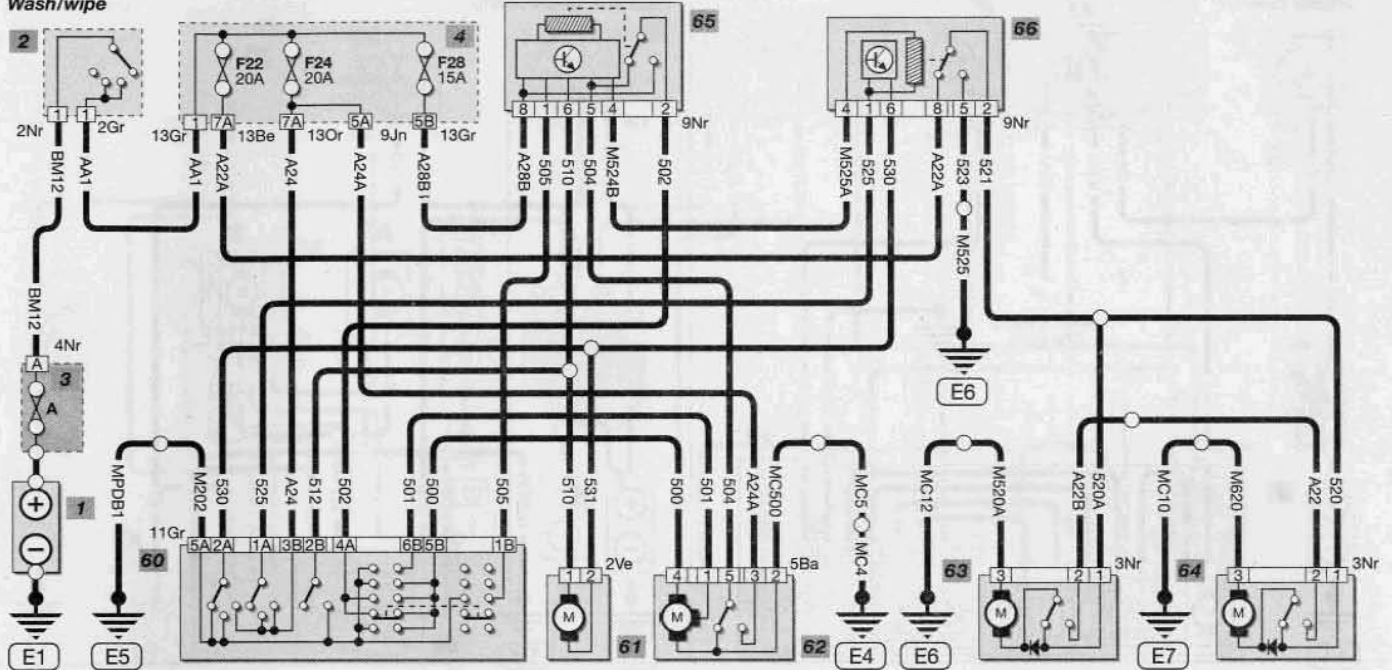

Central locking with deadlocking

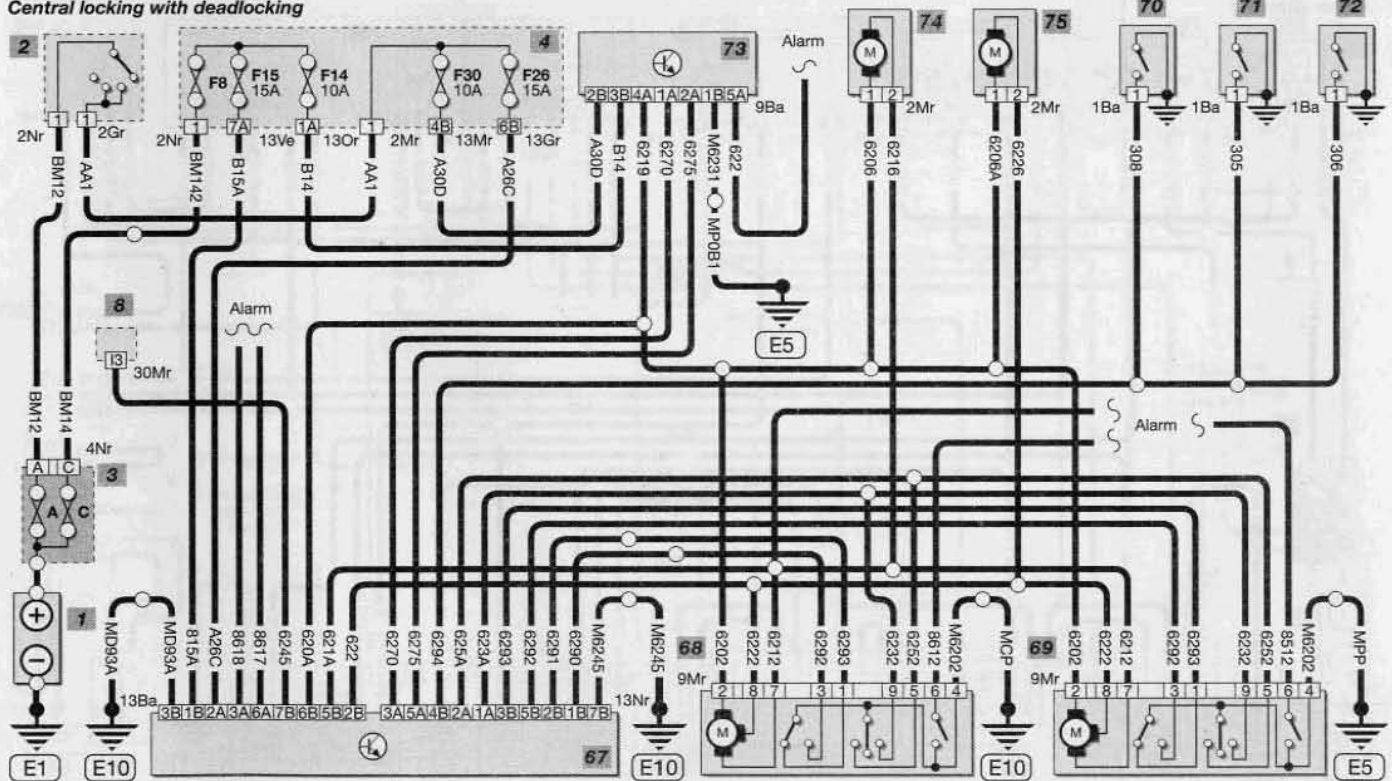

Connector colours

Nr	Black	Or	Orange
Be	Blue	Rg	Red
Mr	Brown	Ba	White
Gr	Grey	Jn	Yellow
Ve	Green		

Key to items

- 1 Battery
- 2 Ignition switch
- 3 Engine fuse box
- 4 Passenger fuse box
- 76 Heater blower panel
- 77 Heater blower switches
- 78 Heater blower resistor pack

- 79 A/C heating controls
- 80 Blower motor
- 81 A/C panel
- 82 Passenger compartment thermostat
- 83 Evaporator temperature sensor
- 84 A/C switches
- 85 Blower motor relay
- 86 A/C compressor relay
- 87 A/C compressor
- 88 A/C cut-off relay
- 89 Pressostat
- 90 A/C control unit

- 91 Engine coolant temperature sensor
- 92 Engine cooling relay
- 93 Cooling fan switch
- 94 RH cooling fan
- 95 LH cooling fan

Diagram 6

MTS H33272

Heater blower

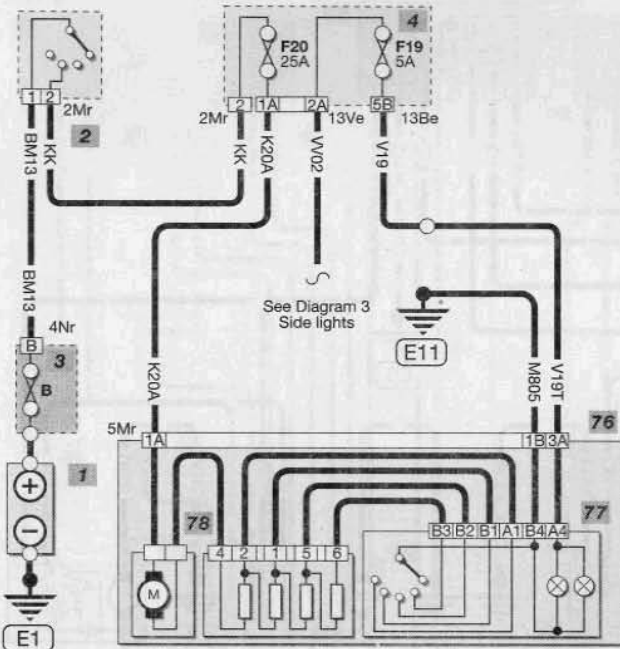

Typical engine cooling

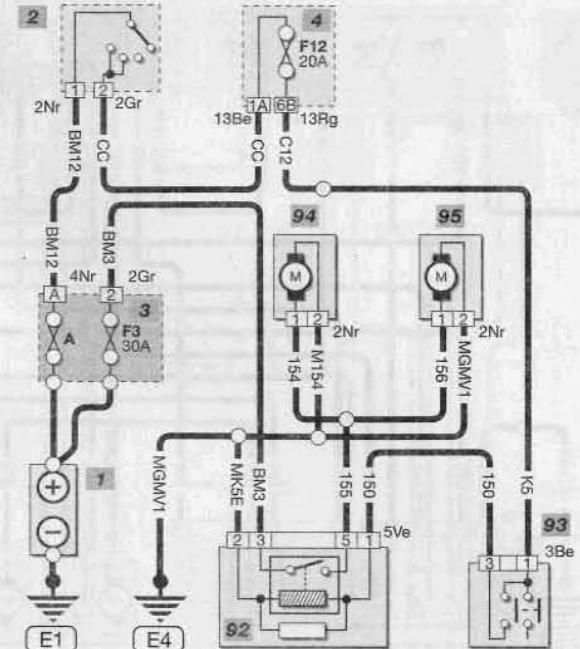

Air conditioning

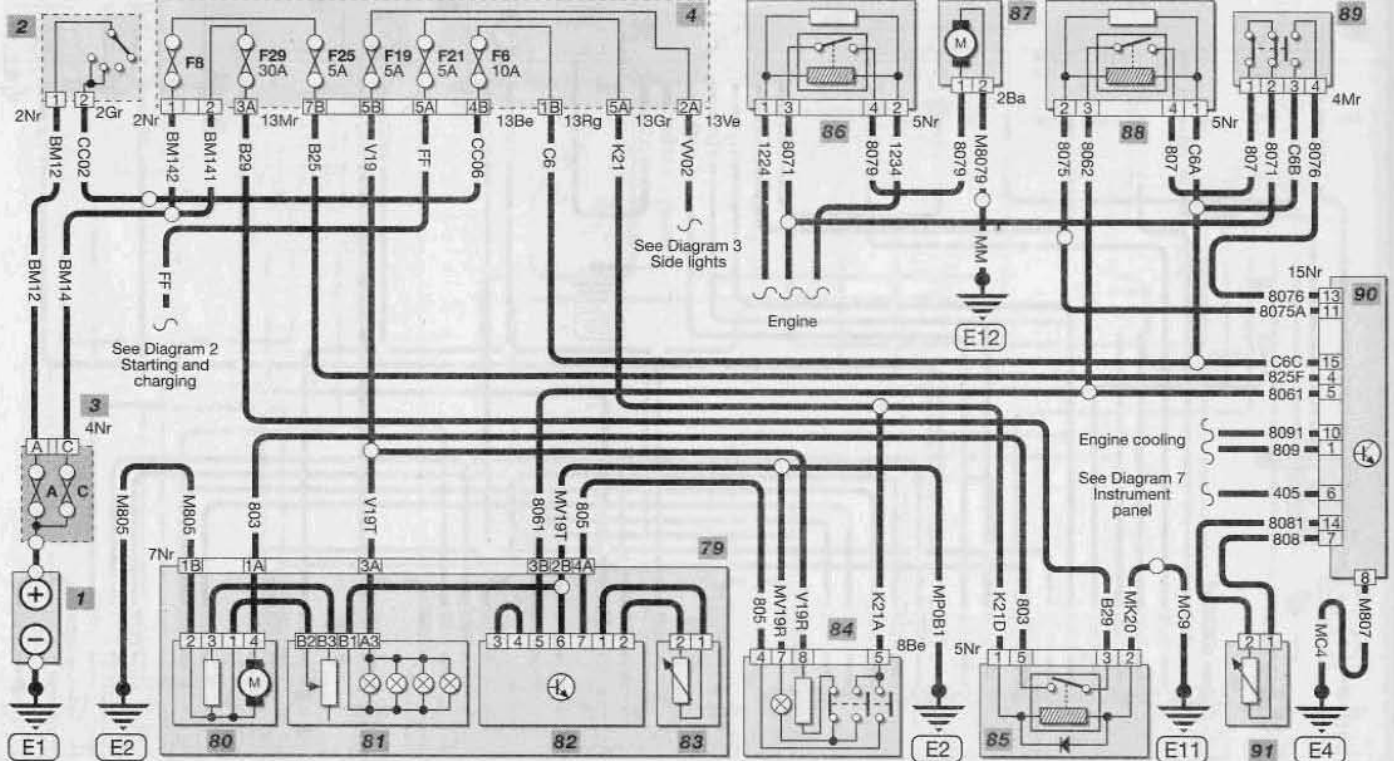

Connector colours

Nr	Black	Or	Orange
Be	Blue	Rg	Red
Mr	Brown	Ba	White
Gr	Grey	Jn	Yellow
Ve	Green		

Key to items

- |    |                         |     |                      |
|----|-------------------------|-----|----------------------|
| 1  | Battery                 | 99  | Front interior light |
| 2  | Ignition switch         | 100 | Rear interior light  |
| 3  | Engine fuse box         | 101 | Map reading light    |
| 4  | Passenger fuse box      | 102 | Instrument panel     |
| 70 | RH rear door switch     | a)  | illumination         |
| 71 | Passenger's door switch | b)  | LH indicator         |
| 72 | Driver's door switch    | c)  | RH indicator         |
| 96 | Mirror control switches | d)  | clock                |
| 97 | Passenger's mirror      | e)  | handbrake warning    |
| 98 | Driver's mirror         | f)  | ABS warning          |

- |    |                             |     |                          |
|----|-----------------------------|-----|--------------------------|
| g) | airbag warning              | 103 | Coolant level sensor     |
| h) | coolant temperature warning | 104 | LH brake pad wear sensor |
| i) | oil pressure warning        | 105 | RH brake pad wear sensor |
| j) | dipped beam                 | 106 | Brake fluid level sensor |
| k) | hi beam warning             | 107 | Handbrake switch         |
| l) | fog light                   | 108 | Fuel level sensor        |
| m) | charge warning              | 109 | Oil level sensor         |
| n) | low coolant warning         | 110 | Oil pressure sensor      |
| o) | brake pad wear warning      |     |                          |
| p) | low fuel warning            |     |                          |

Diagram 7

MTS  
H33273

Electric mirrors

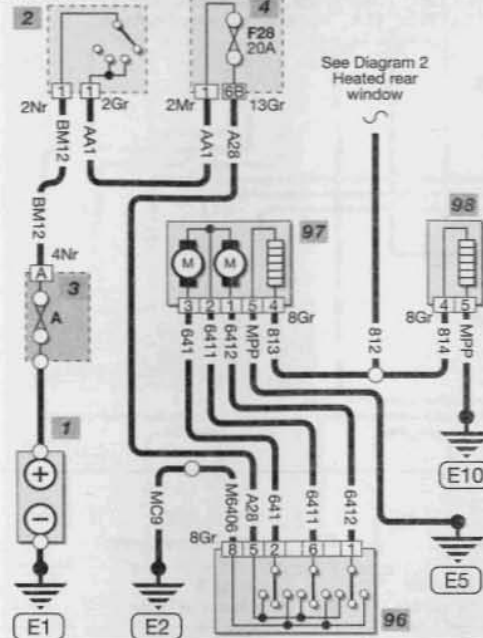

Interior lights

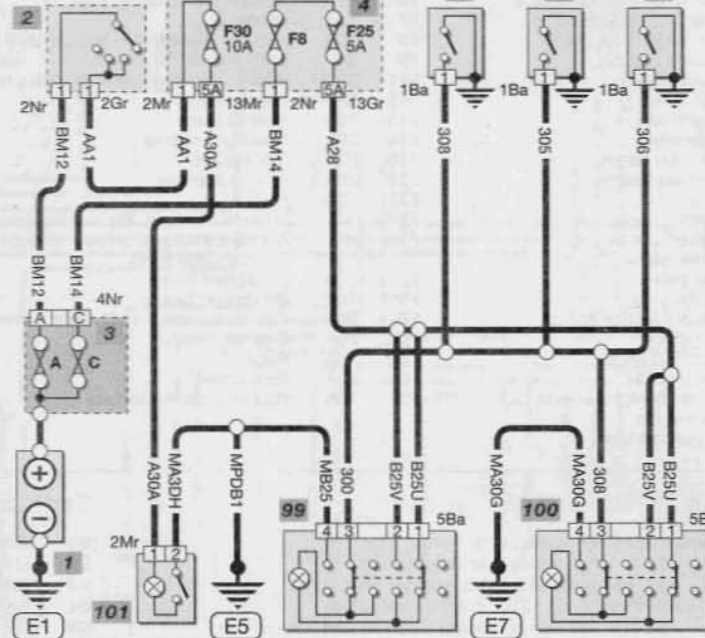

Instrument panel

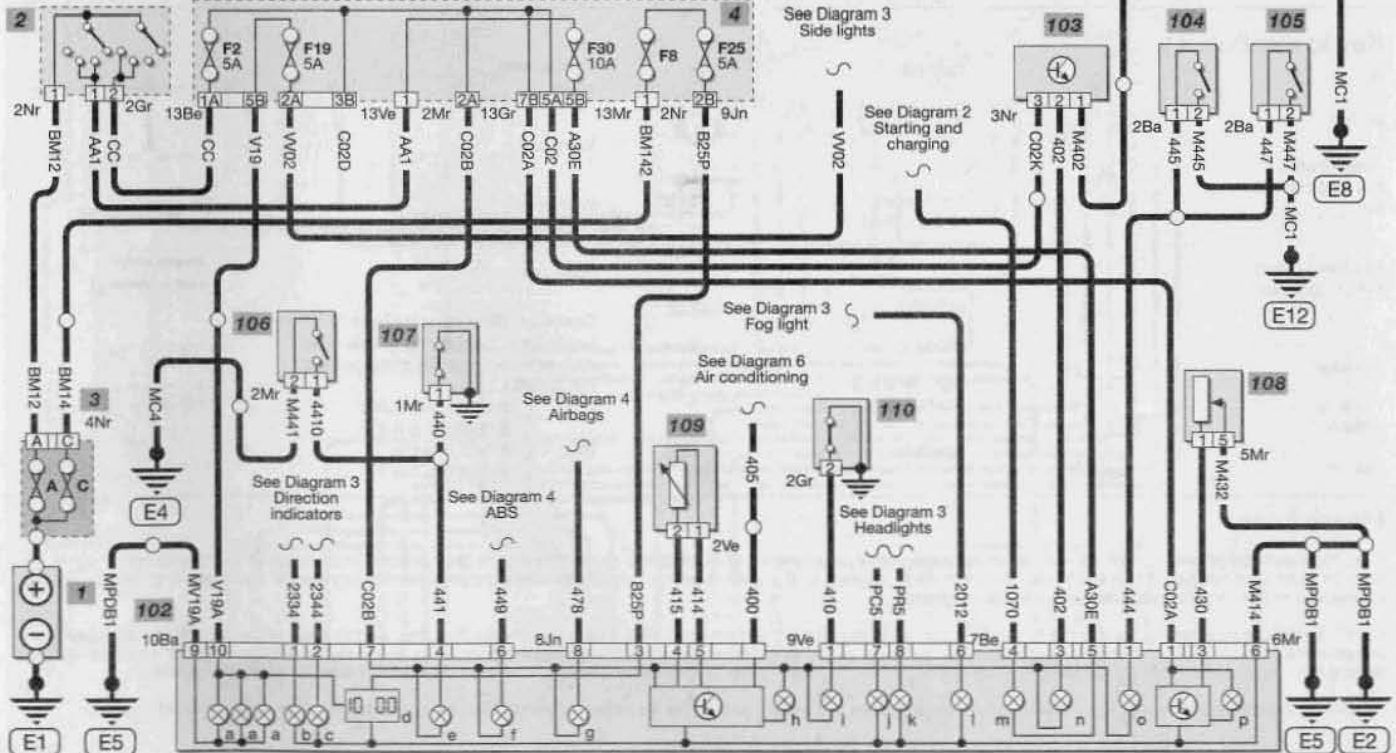



## CITROEN BERLINGO

## Diagram 1

## Fuse table

## Engine fuse box

Fuses	Rating	Circuit protected
F1	70A	Built-in systems interface
F5	20A	Built-in systems interface
F7	20A	Additional heater
F8	70A	Passenger fuse box
F9	50A	Built-in systems interface
F10	40A	Rear wipers, lights
F11	60A	Passenger fuse box
F12	50A	Ignition switch
F14	20A	Injection relay
F15	50A	ABS
F16	20A	Engine fan
F17	20A	Engine fan
F18	10A	RH main beam
F19	10A	LH main beam
F20	10A	ABS
F21	5A	Alarm
F22	20A	Carburettor heater
F23	15A	Diesel heater
F25	15A	Fuel pump
F26	40A	Double relay
F28	10A	Diesel injection pump
F29	30A	Air pump
F30	10A	Front fog lights
F32	10A	Engine ECU
F33	15A	Reversing light, engine ECU, cooling fan
F34	5A	Oxygen sensor

## Passenger fuse box

Fuses	Rating	Circuit protected
F1	Shunt	Airbag
F2	5A	Instrument panel
F4	5A	Built-in systems interface
F5	10A	Brake light switch
F6	5A	Dipped beam, clock
F7	10A	Engine ECU
F8	10A	Radio, interior lights, navigation
F9	5A	Built-in systems interface
F11	5A	Built-in systems interface, radio, heating
F12	5A	Fog lights
F13	15A	Heated seats
F14	30A	Headlight washer
F15	20A	12V socket
F16	30A	Air conditioning
F17	15A	Horn
F18	5A	LH front sidelight, RH rear tail light
F19	5A	RH front sidelight, LH rear tail light, number plate lights
F20	10A	LH dipped beam
F21	10A	RH dipped beam
F22	20A	Electric mirrors, interior lights, navigation
F23	20A	Cigarette lighter
F24	15A	Radio
F25	20A	Rear wiper
F27	10A	Built-in system interface

## Built-in systems interface fuse box

Fuses	Rating	Circuit protected
FA	20A	Central locking
FB	25A	Wipe/wash
FC	30A	Heated rear windscreen and mirrors
FD	15A	Air conditioning, rear wiper
FE	30A	Electric windows, sunroof
FF	15A	Built-in systems interface

## Key to circuits

Diagram 1	Information for wiring diagrams
Diagram 2	Wash/wipe, central locking with deadlocking
Diagram 3	Headlights, tail lights, side lights, number plate lights
Diagram 4	Brake lights, reversing lights, direction indicators
Diagram 5	Fog lights, cigarette lighter, electric windows and sunroof

## Earth points

E1	Battery earth	E7	Inside RH front wing
E2	LH wing	E8	RH lower 'A' pillar above E3
E3	RH lower 'A' pillar	E9	LH lower 'A' pillar above E4
E4	LH lower 'A' pillar		
E5	RH under tail light		
E6	LH under tail light		

## Key to symbols

Bulb		Item no.		Connecting wires	
Switch		Pump/motor		Wire joint	
Fuse/fusible link and current rating		Earth point and location		Wire colour (brown with black tracer)	
Multiple contact switch (ganged)		Solenoid actuator		Screened cable	
Resistor		Diode		Dashed outline denotes part of a larger item, containing in this case an electronic or solid state device.	
Variable resistor		Light emitting diode (LED)		Pin types:	
Heater		Speaker		2 - Unspecified colour connector, pin 2.	
				2Mr 1 - Brown two pin connector, pin 1.	

## Please Note

The prime method of wire identification is by using the terminal pin numbers (moulded into each component or connector and shown in the diagrams) together with the number code printed on each wire. To relate each diagram to the vehicle wiring, locate the relevant component or connector illustrated and find the wire(s) connected to the terminal pin(s) as shown in the diagram.

Caution: Whilst a number (indicating the function of that wire) may be printed on each wire, this is not always the case, and in such instances, this is reflected by the absence of such wire numbering on our diagrams. Similarly, numbering of the connector/component terminal pins is not always available from the manufacturers' source information and may also be missing from our diagrams. In these cases, it may be necessary to refer to your local dealer for further information.

Note that the conventional method of using colour coding does not apply - whilst the wires on the vehicle will be coloured, the wire colour has no relevance.

Connector colours

- Nr Black
- Be Blue
- Mr Brown
- Gr Grey
- Ve Green
- Or Orange
- Rg Red
- Ba White
- Jn Yellow

Key to items

- 1 Battery
- 2 Ignition switch
- 3 Engine fuse box
- 4 Passenger fuse box
- 5 Built-in system interface
- 6 Steering wheel switches
- 7 Washer pump
- 8 Wiper motor
- 9 LH rear wiper motor
- 10 RH rear wiper motor
- 11 Passenger's door lock motor
- 12 Driver's door lock motor
- 13 LH rear door lock motor
- 14 Tailgate lock motor
- 15 RH rear door lock motor

Diagram 2

MTS  
H33275

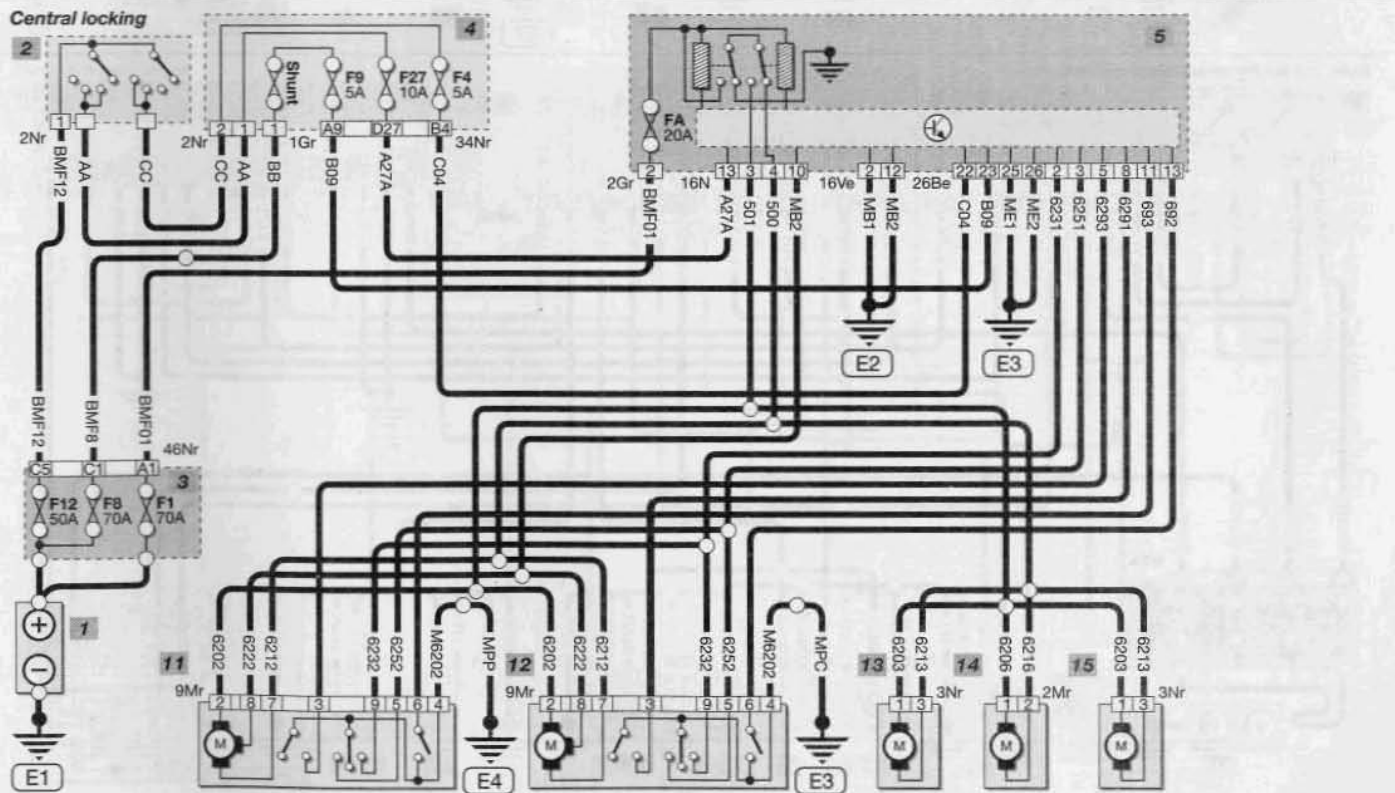
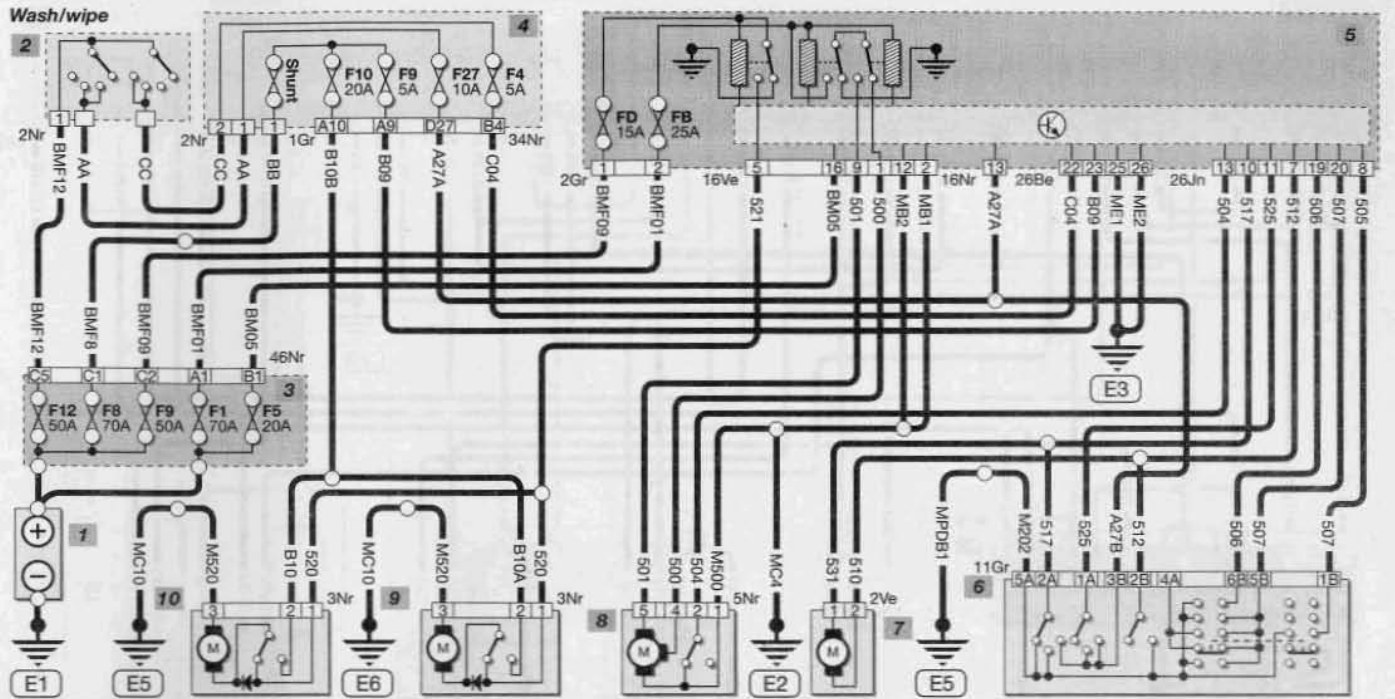

274

Connector colours

Nr	Black	Or	Orange
Be	Blue	Rg	Red
Mr	Brown	Ba	White
Gr	Grey	Jn	Yellow
Ve	Green		

Key to items

1	Battery	16	LH headlight	19	LH tail light
2	Ignition switch	a)	main beam	a)	tail light
3	Engine fuse box	b)	dipped beam	20	RH tail light
4	Passenger fuse box	17	RH headlight	(as 19)	
5	Built-in system interface	18	Dipped beam relay	21	LH number plate light
6	Steering wheel switches			22	RH number plate light

Diagram 3

MTS  
H33276

Headlights

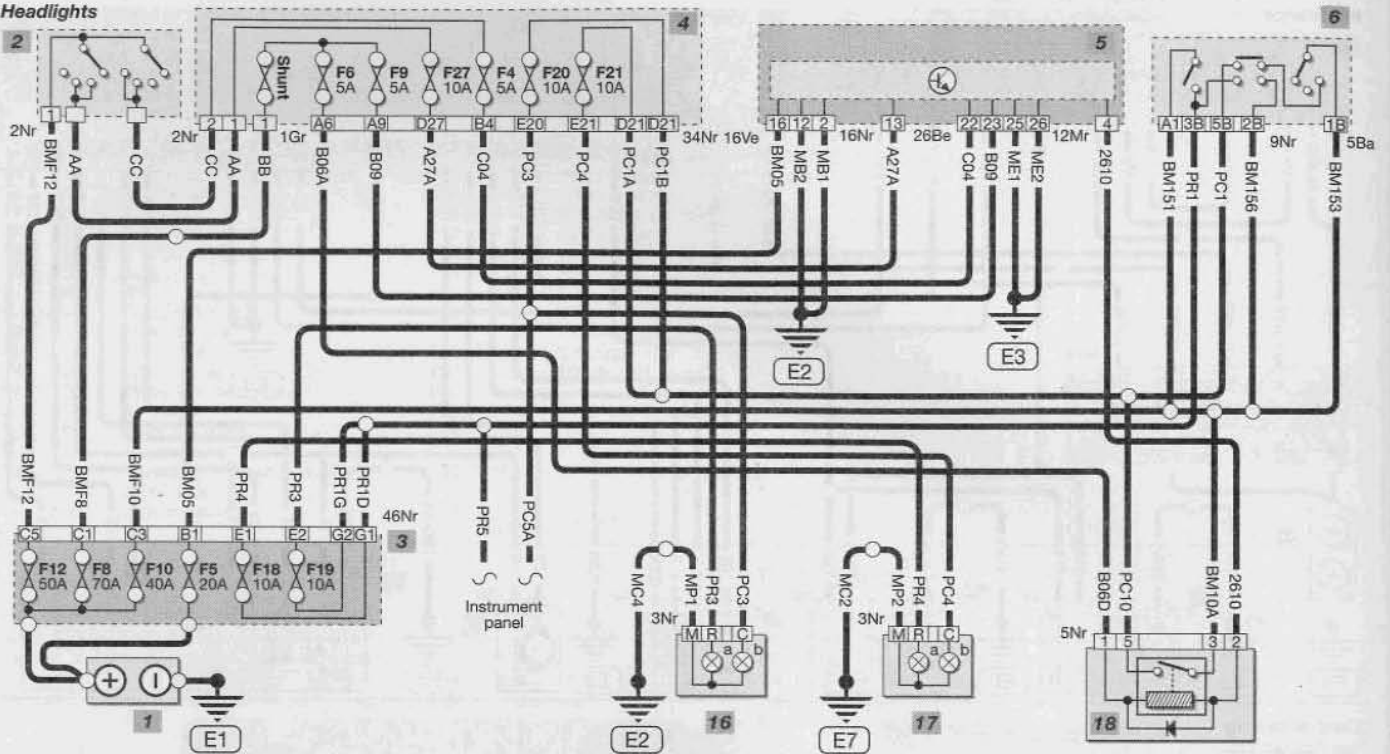

Side, tail and number plate lights

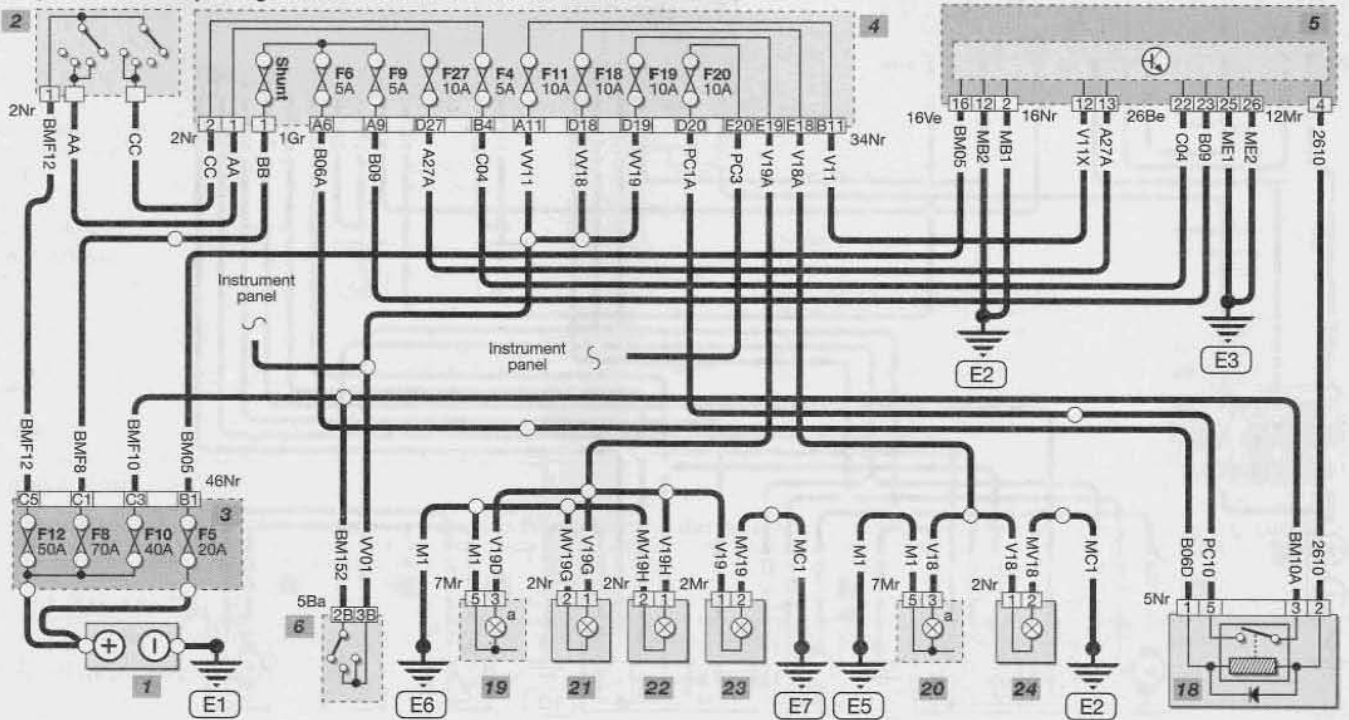



Connector colours

Nr	Black	Or	Orange
Be	Blue	Rg	Red
Mr	Brown	Ba	White
Gr	Grey	Jn	Yellow
Ve	Green		

Key to items

- |   |                           |         |                     |    |                              |
|---|---------------------------|---------|---------------------|----|------------------------------|
| 1 | Battery                   | 19      | LH tail light       | 25 | Brake light switch           |
| 2 | Ignition switch           | b)      | brake light         | 26 | Reversing light switch       |
| 3 | Engine fuse box           | c)      | reversing light     | 27 | Hazard light switch          |
| 4 | Passenger fuse box        | d)      | direction indicator | 28 | LH front direction indicator |
| 5 | Built-in system interface | 20      | RH tail light       | 29 | LH side direction indicator  |
| 6 | Steering wheel switches   | (as 19) |                     | 30 | RH side direction indicator  |
|   |                           |         |                     | 31 | RH front direction indicator |

Diagram 4

MTS  
H33277

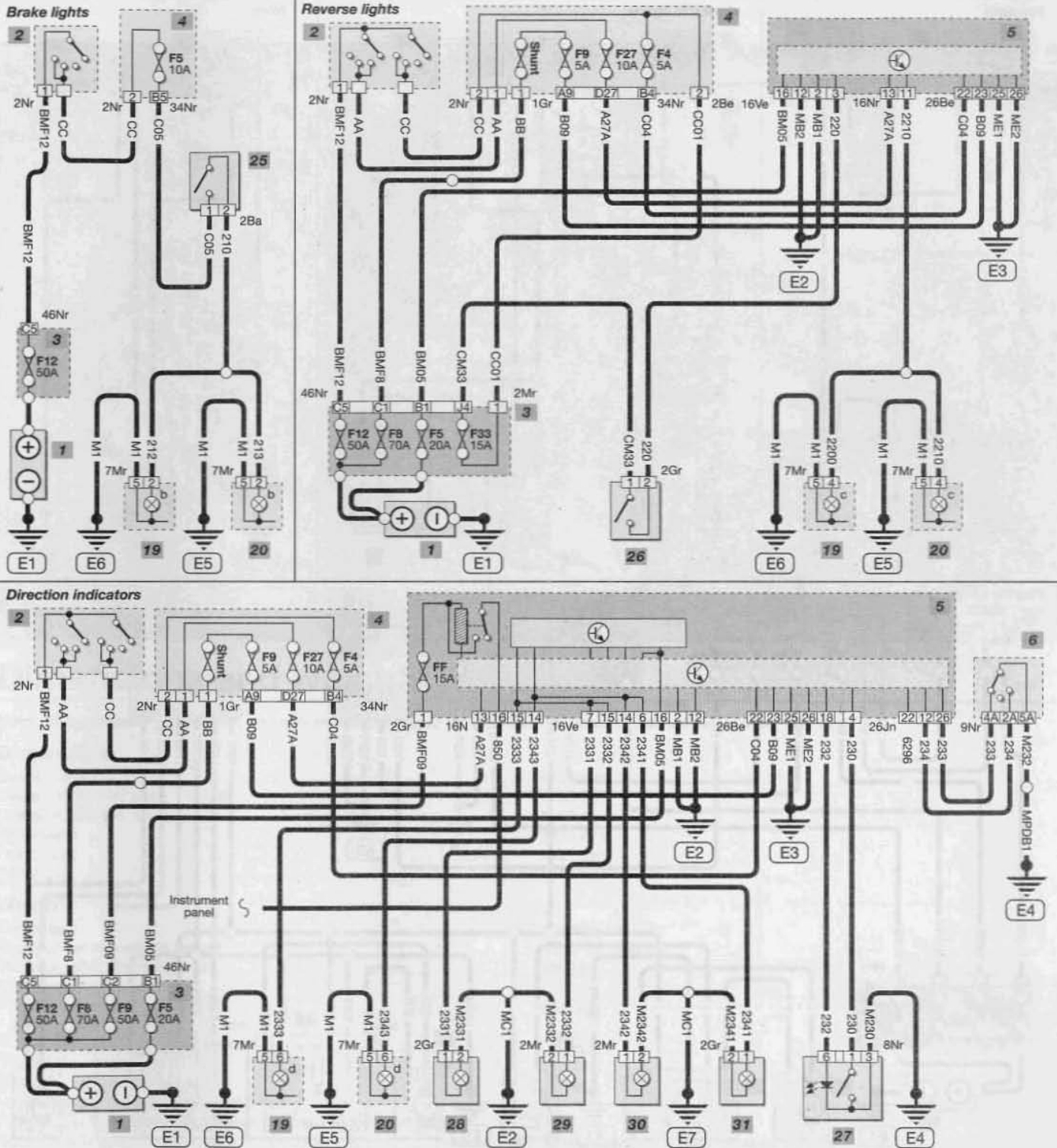

Connector colours

Nr	Black	Or	Orange
Be	Blue	Rg	Red
Mr	Brown	Ba	White
Gr	Grey	Jn	Yellow
Ve	Green		

Key to items

1	Battery	20	RH tail light	36	Sunroof switch
2	Ignition switch	a)	fog light	37	Sunroof limit switch
3	Engine fuse box	32	Cigarette lighter	38	LH window motor
4	Passenger fuse box	33	Ashtray illumination	39	LH window switch
5	Built-in system interface	34	Horn	40	RH window switch
6	Steering wheel switches	35	Sunroof motor	41	RH window motor
				42	Electric window control unit

Diagram 5

MTS  
H33278

Fog light

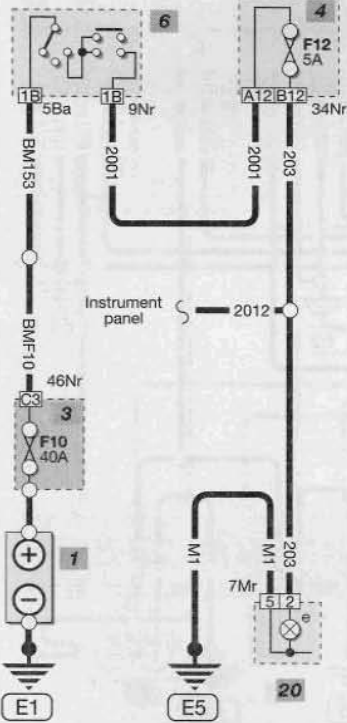

Cigarette lighter

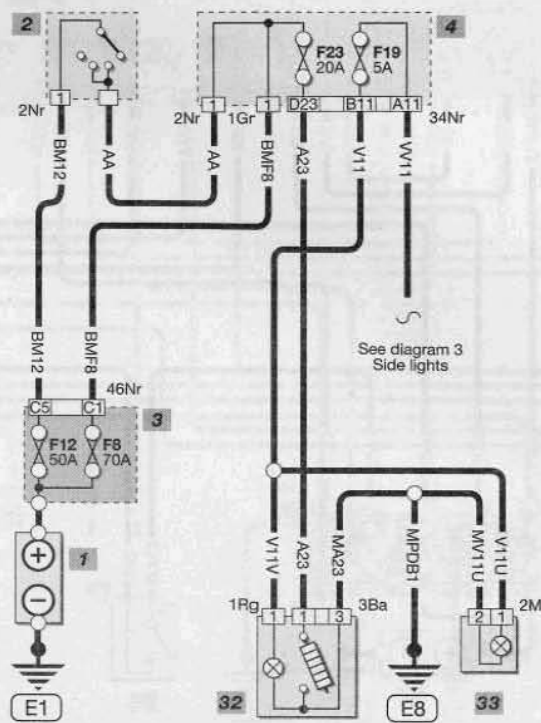

Horn

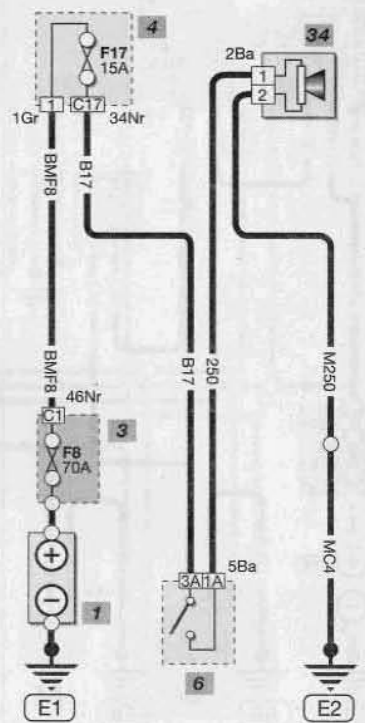

Electric windows and sunroof

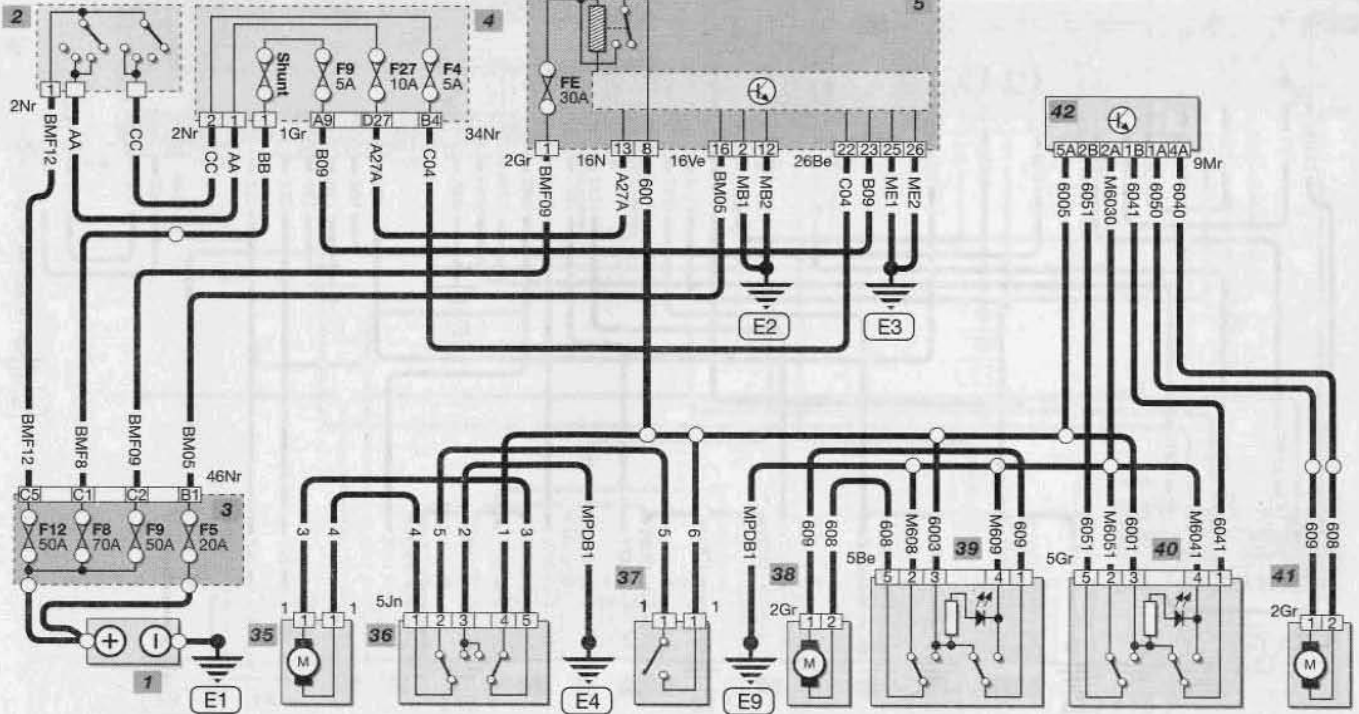

Dimensions and weights .....	REF•1	Disconnecting the battery .....	REF•5
Conversion factors .....	REF•2	Tools and working facilities .....	REF•6
Buying spare parts .....	REF•3	MOT test checks .....	REF•8
Vehicle identification numbers .....	REF•3	Fault finding .....	REF•12
Jacking and vehicle support .....	REF•3	Glossary of technical terms .....	REF•21
General repair procedures .....	REF•4	Index .....	REF•26



## Dimensions and weights

**Note:** All figures are approximate, and may vary according to model. Refer to manufacturer's data for exact figures.

### Dimensions

Overall length .....	4108 mm
Overall width (including mirrors) .....	1900 mm
Overall height (unladen) .....	1802 mm
Wheelbase .....	2690 mm
Front track .....	1422 mm
Rear track .....	1440 mm

### Weights

Kerb weight* .....	1108 to 1211 kg
Maximum gross vehicle weight* .....	1690 to 1990 kg
Maximum roof rack load .....	100 kg
Maximum towing weight:**	
Unbraked trailer .....	500 kg
Braked trailer:	
1.4 litre petrol engine models .....	900 kg
All other models .....	1100 kg
Maximum trailer nose weight .....	70 kg

\* Depending on model and specification.

\*\* Refer to a Peugeot/Citroën dealer for exact recommendations.

**Note:** All figures are approximate, and may vary according to model. Refer to manufacturer's data for exact figures.



# REF•2 Conversion factors

## Length (distance)

Inches (in)	x 25.4 = Millimetres (mm)	x 0.0394 = Inches (in)
Feet (ft)	x 0.305 = Metres (m)	x 3.281 = Feet (ft)
Miles	x 1.609 = Kilometres (km)	x 0.621 = Miles

## Volume (capacity)

Cubic inches (cu in; in <sup>3</sup> )	x 16.387 = Cubic centimetres (cc; cm <sup>3</sup> )	x 0.061 = Cubic inches (cu in; in <sup>3</sup> )
Imperial pints (Imp pt)	x 0.568 = Litres (l)	x 1.76 = Imperial pints (Imp pt)
Imperial quarts (Imp qt)	x 1.137 = Litres (l)	x 0.88 = Imperial quarts (Imp qt)
Imperial quarts (Imp qt)	x 1.201 = US quarts (US qt)	x 0.833 = Imperial quarts (Imp qt)
US quarts (US qt)	x 0.946 = Litres (l)	x 1.057 = US quarts (US qt)
Imperial gallons (Imp gal)	x 4.546 = Litres (l)	x 0.22 = Imperial gallons (Imp gal)
Imperial gallons (Imp gal)	x 1.201 = US gallons (US gal)	x 0.833 = Imperial gallons (Imp gal)
US gallons (US gal)	x 3.785 = Litres (l)	x 0.264 = US gallons (US gal)

## Mass (weight)

Ounces (oz)	x 28.35 = Grams (g)	x 0.035 = Ounces (oz)
Pounds (lb)	x 0.454 = Kilograms (kg)	x 2.205 = Pounds (lb)

## Force

Ounces-force (ozf; oz)	x 0.278 = Newtons (N)	x 3.6 = Ounces-force (ozf; oz)
Pounds-force (lbf; lb)	x 4.448 = Newtons (N)	x 0.225 = Pounds-force (lbf; lb)
Newtons (N)	x 0.1 = Kilograms-force (kgf; kg)	x 9.81 = Newtons (N)

## Pressure

Pounds-force per square inch (psi; lbf/in <sup>2</sup> ; lb/in <sup>2</sup> )	x 0.070 = Kilograms-force per square centimetre (kgf/cm <sup>2</sup> ; kg/cm <sup>2</sup> )	x 14.223 = Pounds-force per square inch (psi; lbf/in <sup>2</sup> ; lb/in <sup>2</sup> )
Pounds-force per square inch (psi; lbf/in <sup>2</sup> ; lb/in <sup>2</sup> )	x 0.068 = Atmospheres (atm)	x 14.696 = Pounds-force per square inch (psi; lbf/in <sup>2</sup> ; lb/in <sup>2</sup> )
Pounds-force per square inch (psi; lbf/in <sup>2</sup> ; lb/in <sup>2</sup> )	x 0.069 = Bars	x 14.5 = Pounds-force per square inch (psi; lbf/in <sup>2</sup> ; lb/in <sup>2</sup> )
Pounds-force per square inch (psi; lbf/in <sup>2</sup> ; lb/in <sup>2</sup> )	x 6.895 = Kilopascals (kPa)	x 0.145 = Pounds-force per square inch (psi; lbf/in <sup>2</sup> ; lb/in <sup>2</sup> )
Kilopascals (kPa)	x 0.01 = Kilograms-force per square centimetre (kgf/cm <sup>2</sup> ; kg/cm <sup>2</sup> )	x 98.1 = Kilopascals (kPa)
Millibar (mbar)	x 100 = Pascals (Pa)	x 0.01 = Millibar (mbar)
Millibar (mbar)	x 0.0145 = Pounds-force per square inch (psi; lbf/in <sup>2</sup> ; lb/in <sup>2</sup> )	x 68.947 = Millibar (mbar)
Millibar (mbar)	x 0.75 = Millimetres of mercury (mmHg)	x 1.333 = Millibar (mbar)
Millibar (mbar)	x 0.401 = Inches of water (inH <sub>2</sub> O)	x 2.491 = Millibar (mbar)
Millimetres of mercury (mmHg)	x 0.535 = Inches of water (inH <sub>2</sub> O)	x 1.868 = Millimetres of mercury (mmHg)
Inches of water (inH <sub>2</sub> O)	x 0.036 = Pounds-force per square inch (psi; lbf/in <sup>2</sup> ; lb/in <sup>2</sup> )	x 27.68 = Inches of water (inH <sub>2</sub> O)

## Torque (moment of force)

Pounds-force inches (lbf in; lb in)	x 1.152 = Kilograms-force centimetre (kgf cm; kg cm)	x 0.868 = Pounds-force inches (lbf in; lb in)
Pounds-force inches (lbf in; lb in)	x 0.113 = Newton metres (Nm)	x 8.85 = Pounds-force inches (lbf in; lb in)
Pounds-force inches (lbf in; lb in)	x 0.083 = Pounds-force feet (lbf ft; lb ft)	x 12 = Pounds-force inches (lbf in; lb in)
Pounds-force feet (lbf ft; lb ft)	x 0.138 = Kilograms-force metres (kgf m; kg m)	x 7.233 = Pounds-force feet (lbf ft; lb ft)
Pounds-force feet (lbf ft; lb ft)	x 1.356 = Newton metres (Nm)	x 0.738 = Pounds-force feet (lbf ft; lb ft)
Newton metres (Nm)	x 0.102 = Kilograms-force metres (kgf m; kg m)	x 9.804 = Newton metres (Nm)

## Power

Horsepower (hp)	x 745.7 = Watts (W)	x 0.0013 = Horsepower (hp)
-----------------	---------------------	----------------------------

## Velocity (speed)

Miles per hour (miles/hr; mph)	x 1.609 = Kilometres per hour (km/hr; kph)	x 0.621 = Miles per hour (miles/hr; mph)
--------------------------------	--	--

## Fuel consumption\*

Miles per gallon, Imperial (mpg)	x 0.354 = Kilometres per litre (km/l)	x 2.825 = Miles per gallon, Imperial (mpg)
Miles per gallon, US (mpg)	x 0.425 = Kilometres per litre (km/l)	x 2.352 = Miles per gallon, US (mpg)

## Temperature

Degrees Fahrenheit = (°C x 1.8) + 32                      Degrees Celsius (Degrees Centigrade; °C) = (°F - 32) x 0.56

\* It is common practice to convert from miles per gallon (mpg) to litres/100 kilometres (l/100km), where mpg x l/100 km = 282

Spare parts are available from many sources, including maker's appointed garages, accessory shops, and motor factors. To be sure of obtaining the correct parts, it may sometimes be necessary to quote the vehicle identification number. If possible, it can also be useful to take the old parts along for positive identification. Items such as starter motors and alternators maybe available under a service exchange scheme – any parts returned should be clean.

Our advice regarding spare part sources is as follows.

## Officially-appointed garages

This is the best source of parts which are peculiar to your car, and are not otherwise generally available (eg, badges, interior trim, certain body panels, etc). It is also the only place at which you should buy parts if the vehicle is still under warranty.

## Accessory shops

These are very good places to buy

materials and components needed for the maintenance of your car (oil, air and fuel filters, spark plugs, light bulbs, drivebelts, oils and greases, brake pads, touch-up paint, etc). Components of this nature sold by a reputable shop are of the same standard as those used by the car manufacturer.

Besides components, these shops will also sell tools and general accessories, usually have convenient opening hours, charge lower prices, and can often be found close to home. Some accessory shops also have parts counters where components needed for almost any repair job can be purchased or ordered.

## Motor factors

Good factors will stock all the more important components which wear out comparatively quickly and can sometimes supply individual components needed for the overhaul of a larger assembly. They may also

handle work such as cylinder block reboring, crankshaft regrinding and balancing, etc.

## Tyre and exhaust specialists

These outlets may be independent or members of a local or national chain. They frequently offer competitive prices when compared with a main dealer or local garage, but it will pay to obtain several quotes before making a decision. Also ask what 'extras' may be added to the quote – for instance, fitting a new valve and balancing the wheel are both often charged on top of the price of a new tyre.

## Other sources

Beware of parts or materials obtained from market stalls, car boot sales or similar outlets. Such items are not invariably sub-standard, but there is little chance of compensation if they do prove unsatisfactory. In the case of safety-critical components such as brake pads there is the risk not only of financial loss but also of an accident causing injury or death.

## Vehicle identification

Modifications are a continuing and unpublicised process in vehicle manufacture, quite apart from major model changes. Spare parts manuals and lists are compiled upon a numerical basis, the individual vehicle identification numbers being essential for correct identification of the part concerned.

When ordering spare parts, always give as much information as possible. Quote the car model, year of manufacture, VIN and engine numbers, as appropriate.

The *vehicle identification (chassis) number*

is stamped into the body, along the top edge of the right-hand wing, and can be viewed with the bonnet open.

The *manufacturer's chassis plate* (which also carries the vehicle identification number) is located on the right-hand side of the engine compartment adjacent to the suspension strut turret. Additional identification numbers for weight information and paint codes are located on, or adjacent to this plate.

The *engine number* is situated on the front face of the cylinder block, and can be found in the following locations:

- On petrol engines the engine number is located on the left-hand side of the cylinder block. The number is either stamped directly onto the block or is stamped onto a plate which is riveted to the block.
- On diesel engines the engine number is stamped on the base of the cylinder block on the flat surface located on the right-hand side of the oil filter/cooler.

**Note:** The first part of the engine number gives the engine code, eg KFW.

## Jacking and vehicle support

The jack supplied with the vehicle should only be used for changing the roadwheels – see *Wheel changing* at the front of this manual. When carrying out any other kind of work, raise the vehicle using a hydraulic (or 'trolley') jack, and always supplement the jack with axle stands at the vehicle jacking points.

When using a hydraulic jack or axle stands, always position the jack head or axle stand head under one of the relevant jacking points in the ridge on the underside of the sill (**see illustration**).

To raise the front of the vehicle, position the jack with an interposed block of wood underneath the centre of the front subframe. **Do not** jack the vehicle under the sump, or

any of the steering or suspension components.

To raise the rear of the vehicle, position the jack head underneath the centre of the rear axle tubular crossmember. **Do not** attempt to raise the vehicle with the jack positioned underneath the spare wheel, as the vehicle floor will almost certainly be damaged.

The jack supplied with the vehicle locates in the jacking points in the ridge on the underside of the sill. Ensure that the jack head is correctly engaged before attempting to raise the vehicle.

**Never** work under, around, or near a raised vehicle, unless it is adequately supported in at least two places.

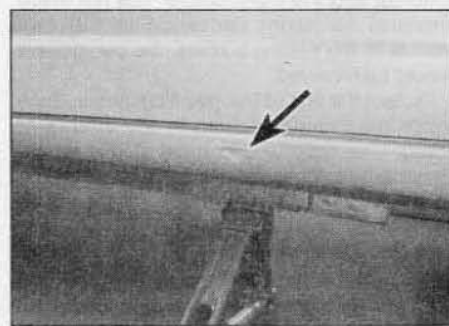

The jacking and supporting point is indicated by a triangle (arrowed on the sill)



Whenever servicing, repair or overhaul work is carried out on the car or its components, observe the following procedures and instructions. This will assist in carrying out the operation efficiently and to a professional standard of workmanship.

### Joint mating faces and gaskets

When separating components at their mating faces, never insert screwdrivers or similar implements into the joint between the faces in order to prise them apart. This can cause severe damage which results in oil leaks, coolant leaks, etc upon reassembly. Separation is usually achieved by tapping along the joint with a soft-faced hammer in order to break the seal. However, note that this method may not be suitable where dowels are used for component location.

Where a gasket is used between the mating faces of two components, a new one must be fitted on reassembly; fit it dry unless otherwise stated in the repair procedure. Make sure that the mating faces are clean and dry, with all traces of old gasket removed. When cleaning a joint face, use a tool which is unlikely to score or damage the face, and remove any burrs or nicks with an oilstone or fine file.

Make sure that tapped holes are cleaned with a pipe cleaner, and keep them free of jointing compound, if this is being used, unless specifically instructed otherwise.

Ensure that all orifices, channels or pipes are clear, and blow through them, preferably using compressed air.

### Oil seals

Oil seals can be removed by levering them out with a wide flat-bladed screwdriver or similar implement. Alternatively, a number of self-tapping screws may be screwed into the seal, and these used as a purchase for pliers or some similar device in order to pull the seal free.

Whenever an oil seal is removed from its working location, either individually or as part of an assembly, it should be renewed.

The very fine sealing lip of the seal is easily damaged, and will not seal if the surface it contacts is not completely clean and free from scratches, nicks or grooves. If the original sealing surface of the component cannot be restored, and the manufacturer has not made provision for slight relocation of the seal relative to the sealing surface, the component should be renewed.

Protect the lips of the seal from any surface which may damage them in the course of fitting. Use tape or a conical sleeve where possible. Lubricate the seal lips with oil before fitting and, on dual-lipped seals, fill the space between the lips with grease.

Unless otherwise stated, oil seals must be fitted with their sealing lips toward the lubricant to be sealed.

Use a tubular drift or block of wood of the appropriate size to install the seal and, if the seal housing is shouldered, drive the seal down to the shoulder. If the seal housing is

unshouldered, the seal should be fitted with its face flush with the housing top face (unless otherwise instructed).

### Screw threads and fastenings

Seized nuts, bolts and screws are quite a common occurrence where corrosion has set in, and the use of penetrating oil or releasing fluid will often overcome this problem if the offending item is soaked for a while before attempting to release it. The use of an impact driver may also provide a means of releasing such stubborn fastening devices, when used in conjunction with the appropriate screwdriver bit or socket. If none of these methods works, it may be necessary to resort to the careful application of heat, or the use of a hacksaw or nut splitter device.

Studs are usually removed by locking two nuts together on the threaded part, and then using a spanner on the lower nut to unscrew the stud. Studs or bolts which have broken off below the surface of the component in which they are mounted can sometimes be removed using a stud extractor. Always ensure that a blind tapped hole is completely free from oil, grease, water or other fluid before installing the bolt or stud. Failure to do this could cause the housing to crack due to the hydraulic action of the bolt or stud as it is screwed in.

When tightening a castellated nut to accept a split pin, tighten the nut to the specified torque, where applicable, and then tighten further to the next split pin hole. Never slacken the nut to align the split pin hole, unless stated in the repair procedure.

When checking or retightening a nut or bolt to a specified torque setting, slacken the nut or bolt by a quarter of a turn, and then retighten to the specified setting. However, this should not be attempted where angular tightening has been used.

For some screw fastenings, notably cylinder head bolts or nuts, torque wrench settings are no longer specified for the latter stages of tightening, "angle-tightening" being called up instead. Typically, a fairly low torque wrench setting will be applied to the bolts/nuts in the correct sequence, followed by one or more stages of tightening through specified angles.

### Locknuts, locktabs and washers

Any fastening which will rotate against a component or housing during tightening should always have a washer between it and the relevant component or housing.

Spring or split washers should always be renewed when they are used to lock a critical component such as a big-end bearing retaining bolt or nut. Locktabs which are folded over to retain a nut or bolt should always be renewed.

Self-locking nuts can be re-used in non-critical areas, providing resistance can be felt when the locking portion passes over the bolt or stud thread. However, it should be noted that self-locking stiffnuts tend to lose their

effectiveness after long periods of use, and should then be renewed as a matter of course.

Split pins must always be replaced with new ones of the correct size for the hole.

When thread-locking compound is found on the threads of a fastener which is to be re-used, it should be cleaned off with a wire brush and solvent, and fresh compound applied on reassembly.

### Special tools

Some repair procedures in this manual entail the use of special tools such as a press, two or three-legged pullers, spring compressors, etc. Wherever possible, suitable readily-available alternatives to the manufacturer's special tools are described, and are shown in use. In some instances, where no alternative is possible, it has been necessary to resort to the use of a manufacturer's tool, and this has been done for reasons of safety as well as the efficient completion of the repair operation. Unless you are highly-skilled and have a thorough understanding of the procedures described, never attempt to bypass the use of any special tool when the procedure described specifies its use. Not only is there a very great risk of personal injury, but expensive damage could be caused to the components involved.

### Environmental considerations

When disposing of used engine oil, brake fluid, antifreeze, etc, give due consideration to any detrimental environmental effects. Do not, for instance, pour any of the above liquids down drains into the general sewage system, or onto the ground to soak away. Many local council refuse tips provide a facility for waste oil disposal, as do some garages. If none of these facilities are available, consult your local Environmental Health Department, or the National Rivers Authority, for further advice.

With the universal tightening-up of legislation regarding the emission of environmentally-harmful substances from motor vehicles, most vehicles have tamperproof devices fitted to the main adjustment points of the fuel system. These devices are primarily designed to prevent unqualified persons from adjusting the fuel/air mixture, with the chance of a consequent increase in toxic emissions. If such devices are found during servicing or overhaul, they should, wherever possible, be renewed or refitted in accordance with the manufacturer's requirements or current legislation.



OIL BANK LINE  
0800 66 33 66  
www.oilbankline.org.uk

**Note: It is antisocial and illegal to dump oil down the drain. To find the location of your local oil recycling bank, call this number free.**



Numerous systems fitted to the vehicle require battery power to be available at all times, either to ensure their continued operation (such as the clock) or to maintain control unit memories which would be erased if the battery were to be disconnected. Whenever the battery is to be disconnected therefore, first note the following, to ensure that there are no unforeseen consequences of this action:

- a) First, on any vehicle with central locking, it is a wise precaution to remove the key from the ignition, and to keep it with you, so that it does not get locked in if the central locking should engage accidentally when the battery is reconnected.
- b) The majority of models covered in this manual are equipped with a Peugeot/Citroën anti-theft alarm system. When reconnecting the battery after disconnection, the alarm may be automatically activated. If so, use the remote transmitter to turn off the alarm, or turn off the alarm manually by switching on the ignition. To fully reactivate the system once the battery is reconnected, lock then unlock the vehicle using the remote transmitter; the alarm will be functional again the next time the vehicle is locked with the remote transmitter.
- c) If a security-coded audio unit is fitted, and the unit and/or the battery is disconnected, the unit will not function again on reconnection until the correct security code is entered. Details of this procedure, which varies according to the unit fitted, are given in the vehicle owner's handbook. Ensure you have the correct code before you disconnect the battery. If you do not have the code or details of the correct procedure, but can supply proof of ownership and a legitimate reason for wanting this information, a Peugeot/Citroën dealer may be able to help.
- d) On all petrol engines, later 1.9 litre diesel engines and all 2.0 litre diesel engines, the engine management electronic control unit is of the 'self-learning' type, meaning that as it operates, it also monitors and stores the settings which give optimum engine performance under all operating conditions. When the battery is disconnected, these settings are lost and the ECU reverts to the base settings programmed into its memory at the factory. On restarting, this may lead to the engine running/idling roughly for a short while, until the ECU has re-learned the optimum settings. This process is best accomplished by taking the vehicle on a

road test (for approximately 15 minutes), covering all engine speeds and loads, concentrating mainly in the 2500 to 3500 rpm region.

- e) On all models, when reconnecting the battery after disconnection, switch on the ignition and wait 10 seconds to allow the electronic vehicle systems to stabilise and re-initialise.

Devices known as 'memory-savers' (or 'code-savers') can be used to avoid some of the above problems. Precise details vary according to the device used. Typically, it is plugged into the cigarette lighter, and is connected by its own wires to a spare battery; the vehicle's own battery is then disconnected from the electrical system, leaving the 'memory-saver' to pass sufficient current to maintain audio unit security codes and any other memory values, and also to run permanently-live circuits such as the clock.



**Warning:** Some of these devices allow a considerable amount of current to pass, which can mean that many of the vehicle's systems are still operational when the main battery is disconnected. If a 'memory saver' is used, ensure that the circuit concerned is actually 'dead' before carrying out any work on it!

**Introduction**

A selection of good tools is a fundamental requirement for anyone contemplating the maintenance and repair of a motor vehicle. For the owner who does not possess any, their purchase will prove a considerable expense, offsetting some of the savings made by doing-it-yourself. However, provided that the tools purchased meet the relevant national safety standards and are of good quality, they will last for many years and prove an extremely worthwhile investment.

To help the average owner to decide which tools are needed to carry out the various tasks detailed in this manual, we have compiled three lists of tools under the following headings: *Maintenance and minor repair*, *Repair and overhaul*, and *Special*. Newcomers to practical mechanics should start off with the *Maintenance and minor repair* tool kit, and confine themselves to the simpler jobs around the vehicle. Then, as confidence and experience grow, more difficult tasks can be undertaken, with extra tools being purchased as, and when, they are needed. In this way, a *Maintenance and minor repair* tool kit can be built up into a *Repair and overhaul* tool kit over a considerable period of time, without any major cash outlays. The experienced do-it-yourselfer will have a tool kit good enough for most repair and overhaul procedures, and will add tools from the *Special* category when it is felt that the expense is justified by the amount of use to which these tools will be put.

**Maintenance and minor repair tool kit**

The tools given in this list should be considered as a minimum requirement if routine maintenance, servicing and minor repair operations are to be undertaken. We recommend the purchase of combination spanners (ring one end, open-ended the other); although more expensive than open-ended ones, they do give the advantages of both types of spanner.

- Combination spanners:**
  - Metric - 8 to 19 mm inclusive*
- Adjustable spanner - 35 mm jaw (approx.)*
- Spark plug spanner (with rubber insert) - petrol models*
- Spark plug gap adjustment tool - petrol models*
- Set of feeler gauges*
- Brake bleed nipple spanner*
- Screwdrivers:**
  - Flat blade - 100 mm long x 6 mm dia*
  - Cross blade - 100 mm long x 6 mm dia*
  - Torx - various sizes (not all vehicles)*
- Combination pliers*
- Hacksaw (junior)*
- Tyre pump*
- Tyre pressure gauge*
- Oil can*
- Oil filter removal tool*
- Fine emery cloth*
- Wire brush (small)*
- Funnel (medium size)*
- Sump drain plug key (not all vehicles)*

**Repair and overhaul tool kit**

These tools are virtually essential for anyone undertaking any major repairs to a motor vehicle, and are additional to those given in the *Maintenance and minor repair* list. Included in this list is a comprehensive set of sockets. Although these are expensive, they will be found invaluable as they are so versatile - particularly if various drives are included in the set. We recommend the half-inch square-drive type, as this can be used with most proprietary torque wrenches.

The tools in this list will sometimes need to be supplemented by tools from the *Special* list:

- Sockets (or box spanners) to cover range in previous list (including Torx sockets)*
- Reversible ratchet drive (for use with sockets)*
- Extension piece, 250 mm (for use with sockets)*
- Universal joint (for use with sockets)*
- Flexible handle or sliding T "breaker bar" (for use with sockets)*
- Torque wrench (for use with sockets)*
- Self-locking grips*
- Ball pein hammer*
- Soft-faced mallet (plastic or rubber)*
- Screwdrivers:**
  - Flat blade - long & sturdy, short (chubby), and narrow (electrician's) types*
  - Cross blade - long & sturdy, and short (chubby) types*
- Pliers:**
  - Long-nosed*
  - Side cutters (electrician's)*
  - Circlip (internal and external)*
- Cold chisel - 25 mm*
- Scriber*
- Scraper*
- Centre-punch*
- Pin punch*
- Hacksaw*
- Brake hose clamp*
- Brake/clutch bleeding kit*
- Selection of twist drills*
- Steel rule/straight-edge*
- Allen keys (inc. splined/Torx type)*
- Selection of files*
- Wire brush*
- Axle stands*
- Jack (strong trolley or hydraulic type)*
- Light with extension lead*
- Universal electrical multi-meter*

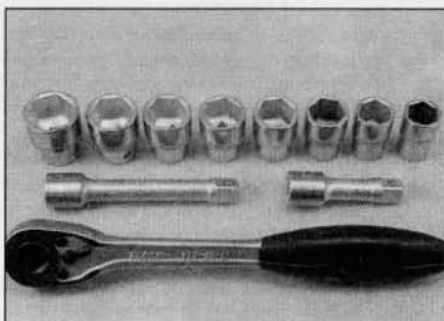

Sockets and reversible ratchet drive



Brake bleeding kit



Torx key, socket and bit

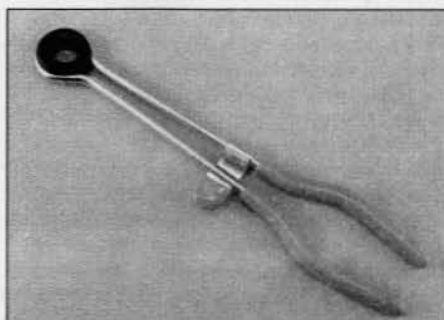

Hose clamp



Angular-tightening gauge

## Special tools

The tools in this list are those which are not used regularly, are expensive to buy, or which need to be used in accordance with their manufacturers' instructions. Unless relatively difficult mechanical jobs are undertaken frequently, it will not be economic to buy many of these tools. Where this is the case, you could consider clubbing together with friends (or joining a motorists' club) to make a joint purchase, or borrowing the tools against a deposit from a local garage or tool hire specialist. It is worth noting that many of the larger DIY superstores now carry a large range of special tools for hire at modest rates.

The following list contains only those tools and instruments freely available to the public, and not those special tools produced by the vehicle manufacturer specifically for its dealer network. You will find occasional references to these manufacturers' special tools in the text of this manual. Generally, an alternative method of doing the job without the vehicle manufacturers' special tool is given. However, sometimes there is no alternative to using them. Where this is the case and the relevant tool cannot be bought or borrowed, you will have to entrust the work to a dealer.

- Angular-tightening gauge
- Valve spring compressor
- Valve grinding tool
- Piston ring compressor
- Piston ring removal/installation tool
- Cylinder bore hone
- Balljoint separator
- Coil spring compressors (where applicable)
- Two/three-legged hub and bearing puller
- Impact screwdriver
- Micrometer and/or vernier calipers
- Dial gauge
- Stroboscopic timing light
- Dwell angle meter/tachometer
- Fault code reader
- Cylinder compression gauge
- Hand-operated vacuum pump and gauge
- Clutch plate alignment set
- Brake shoe steady spring cup removal tool
- Bush and bearing removal/installation set
- Stud extractors
- Tap and die set
- Lifting tackle
- Trolley jack

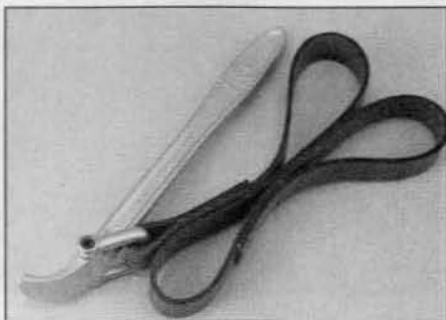

Strap wrench

## Buying tools

Reputable motor accessory shops and superstores often offer excellent quality tools at discount prices, so it pays to shop around.

Remember, you don't have to buy the most expensive items on the shelf, but it is always advisable to steer clear of the very cheap tools. Beware of 'bargains' offered on market stalls or at car boot sales. There are plenty of good tools around at reasonable prices, but always aim to purchase items which meet the relevant national safety standards. If in doubt, ask the proprietor or manager of the shop for advice before making a purchase.

## Care and maintenance of tools

Having purchased a reasonable tool kit, it is necessary to keep the tools in a clean and serviceable condition. After use, always wipe off any dirt, grease and metal particles using a clean, dry cloth, before putting the tools away. Never leave them lying around after they have been used. A simple tool rack on the garage or workshop wall for items such as screwdrivers and pliers is a good idea. Store all normal spanners and sockets in a metal box. Any measuring instruments, gauges, meters, etc, must be carefully stored where they cannot be damaged or become rusty.

Take a little care when tools are used. Hammer heads inevitably become marked, and screwdrivers lose the keen edge on their blades from time to time. A little timely attention with emery cloth or a file will soon restore items like this to a good finish.



Micrometers

## Working facilities

Not to be forgotten when discussing tools is the workshop itself. If anything more than routine maintenance is to be carried out, a suitable working area becomes essential.

It is appreciated that many an owner-mechanic is forced by circumstances to remove an engine or similar item without the benefit of a garage or workshop. Having done this, any repairs should always be done under the cover of a roof.

Wherever possible, any dismantling should be done on a clean, flat workbench or table at a suitable working height.

Any workbench needs a vice; one with a jaw opening of 100 mm is suitable for most jobs. As mentioned previously, some clean dry storage space is also required for tools, as well as for any lubricants, cleaning fluids, touch-up paints etc, which become necessary.

Another item which may be required, and which has a much more general usage, is an electric drill with a chuck capacity of at least 8 mm. This, together with a good range of twist drills, is virtually essential for fitting accessories.

Last, but not least, always keep a supply of old newspapers and clean, lint-free rags available, and try to keep any working area as clean as possible.

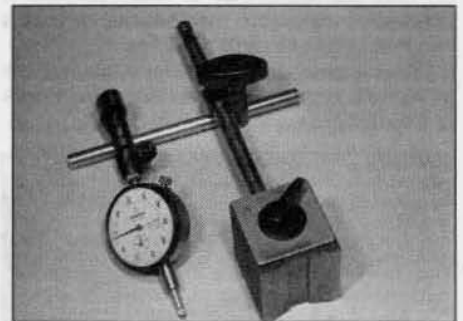

Dial test indicator ("dial gauge")



Compression tester



Fault code reader



## REF•8 Tools and working facilities

This is a guide to getting your vehicle through the MOT test. Obviously it will not be possible to examine the vehicle to the same standard as the professional MOT tester. However, working through the following checks will enable you to identify any problem areas before submitting the vehicle for the test.

Where a testable component is in borderline condition, the tester has discretion in deciding whether to pass or fail it. The basis of such discretion is whether the tester would be happy for a close relative or friend to use the vehicle with the component in that condition. If the vehicle presented is clean and evidently well cared for, the tester may be more inclined to pass a borderline component than if the vehicle is scruffy and apparently neglected.

It has only been possible to summarise the test requirements here, based on the regulations in force at the time of printing. Test standards are becoming increasingly stringent, although there are some exemptions for older vehicles.

An assistant will be needed to help carry out some of these checks.



The checks have been sub-divided into four categories, as follows:

**1** Checks carried out  
**FROM THE DRIVER'S SEAT**

**2** Checks carried out  
**WITH THE VEHICLE ON THE GROUND**

**3** Checks carried out  
**WITH THE VEHICLE RAISED AND THE WHEELS FREE TO TURN**

**4** Checks carried out on  
**YOUR VEHICLE'S EXHAUST EMISSION SYSTEM**

**1** Checks carried out  
**FROM THE DRIVER'S SEAT**

### Handbrake

Test the operation of the handbrake. Excessive travel (too many clicks) indicates incorrect brake or cable adjustment.

Check that the handbrake cannot be released by tapping the lever sideways. Check the security of the lever mountings.

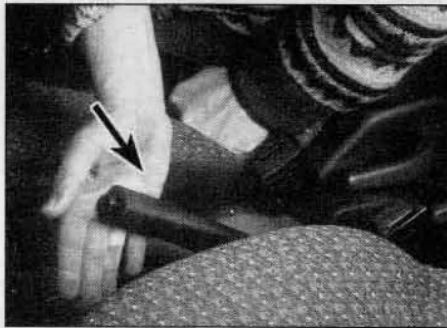

### Footbrake

Depress the brake pedal and check that it does not creep down to the floor, indicating a master cylinder fault. Release the pedal, wait a few seconds, then depress it again. If the pedal travels nearly to the floor before firm resistance is felt, brake adjustment or repair is necessary. If the pedal feels spongy, there is air in the hydraulic system which must be removed by bleeding.

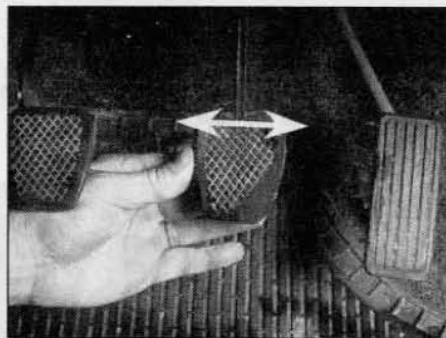

Check that the brake pedal is secure and in good condition. Check also for signs of fluid leaks on the pedal, floor or carpets, which would indicate failed seals in the brake master cylinder.

Check the servo unit (when applicable) by operating the brake pedal several times, then keeping the pedal depressed and starting the engine. As the engine starts, the pedal will move down slightly. If not, the vacuum hose or the servo itself may be faulty.

### Steering wheel and column

Examine the steering wheel for fractures or looseness of the hub, spokes or rim.

Move the steering wheel from side to side and then up and down. Check that the steering wheel is not loose on the column, indicating wear or a loose retaining nut. Continue moving the steering wheel as before, but also turn it slightly from left to right.

Check that the steering wheel is not loose on the column, and that there is no abnormal



movement of the steering wheel, indicating wear in the column support bearings or couplings.

### Windscreen, mirrors and sunvisor

The windscreen must be free of cracks or other significant damage within the driver's field of view. (Small stone chips are acceptable.) Rear view mirrors must be secure, intact, and capable of being adjusted.

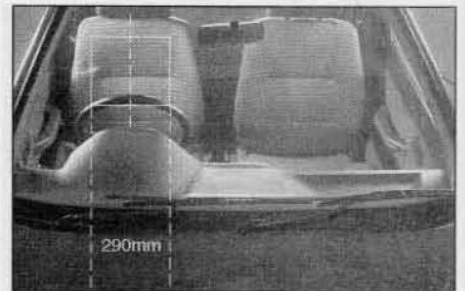

The driver's sunvisor must be capable of being stored in the "up" position.



**Seat belts and seats**

**Note:** The following checks are applicable to all seat belts, front and rear.

- Examine the webbing of all the belts (including rear belts if fitted) for cuts, serious fraying or deterioration. Fasten and unfasten each belt to check the buckles. If applicable, check the retracting mechanism. Check the security of all seat belt mountings accessible from inside the vehicle.
- Seat belts with pre-tensioners, once activated, have a "flag" or similar showing on the seat belt stalk. This, in itself, is not a reason for test failure.
- The front seats themselves must be securely attached and the backrests must lock in the upright position.

**Doors**

- Both front doors must be able to be opened and closed from outside and inside, and must latch securely when closed.

**2** Checks carried out WITH THE VEHICLE ON THE GROUND

**Vehicle identification**

- Number plates must be in good condition, secure and legible, with letters and numbers correctly spaced – spacing at (A) should be at least twice that at (B).



- The VIN plate and/or homologation plate must be legible.

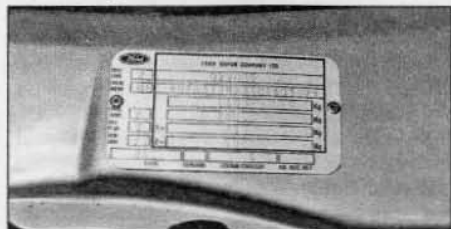

**Electrical equipment**

- Switch on the ignition and check the operation of the horn.
- Check the windscreen washers and wipers, examining the wiper blades; renew damaged or perished blades. Also check the operation of the stop-lights.



- Check the operation of the sidelights and number plate lights. The lenses and reflectors must be secure, clean and undamaged.
- Check the operation and alignment of the headlights. The headlight reflectors must not be tarnished and the lenses must be undamaged.
- Switch on the ignition and check the operation of the direction indicators (including the instrument panel tell-tale) and the hazard warning lights. Operation of the sidelights and stop-lights must not affect the indicators - if it does, the cause is usually a bad earth at the rear light cluster.
- Check the operation of the rear foglight(s), including the warning light on the instrument panel or in the switch.
- The ABS warning light must illuminate in accordance with the manufacturers' design. For most vehicles, the ABS warning light should illuminate when the ignition is switched on, and (if the system is operating properly) extinguish after a few seconds. Refer to the owner's handbook.

**Footbrake**

- Examine the master cylinder, brake pipes and servo unit for leaks, loose mountings, corrosion or other damage.



- The fluid reservoir must be secure and the fluid level must be between the upper (A) and lower (B) markings.

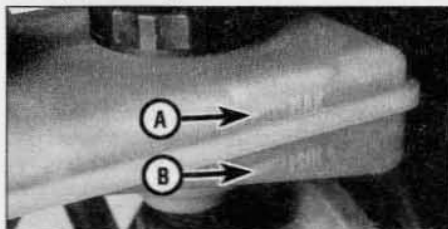

- Inspect both front brake flexible hoses for cracks or deterioration of the rubber. Turn the steering from lock to lock, and ensure that the hoses do not contact the wheel, tyre, or any part of the steering or suspension mechanism. With the brake pedal firmly depressed, check the hoses for bulges or leaks under pressure.



**Steering and suspension**

- Have your assistant turn the steering wheel from side to side slightly, up to the point where the steering gear just begins to transmit this movement to the roadwheels. Check for excessive free play between the steering wheel and the steering gear, indicating wear or insecurity of the steering column joints, the column-to-steering gear coupling, or the steering gear itself.
- Have your assistant turn the steering wheel more vigorously in each direction, so that the roadwheels just begin to turn. As this is done, examine all the steering joints, linkages, fittings and attachments. Renew any component that shows signs of wear or damage. On vehicles with power steering, check the security and condition of the steering pump, drivebelt and hoses.
- Check that the vehicle is standing level, and at approximately the correct ride height.

**Shock absorbers**

- Depress each corner of the vehicle in turn, then release it. The vehicle should rise and then settle in its normal position. If the vehicle continues to rise and fall, the shock absorber is defective. A shock absorber which has seized will also cause the vehicle to fail.





**Exhaust system**

□ Start the engine. With your assistant holding a rag over the tailpipe, check the entire system for leaks. Repair or renew leaking sections.

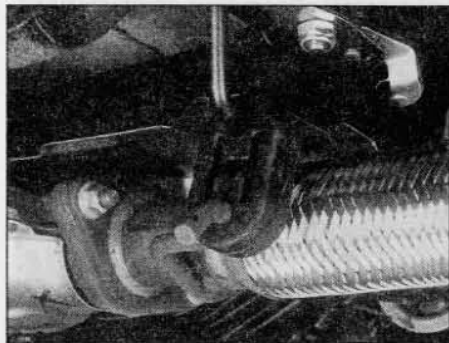

### 3 Checks carried out WITH THE VEHICLE RAISED AND THE WHEELS FREE TO TURN

*Jack up the front and rear of the vehicle, and securely support it on axle stands. Position the stands clear of the suspension assemblies. Ensure that the wheels are clear of the ground and that the steering can be turned from lock to lock.*

**Steering mechanism**

□ Have your assistant turn the steering from lock to lock. Check that the steering turns smoothly, and that no part of the steering mechanism, including a wheel or tyre, fouls any brake hose or pipe or any part of the body structure.

□ Examine the steering rack rubber gaiters for damage or insecurity of the retaining clips. If power steering is fitted, check for signs of damage or leakage of the fluid hoses, pipes or connections. Also check for excessive stiffness or binding of the steering, a missing split pin or locking device, or severe corrosion of the body structure within 30 cm of any steering component attachment point.

**Front and rear suspension and wheel bearings**

□ Starting at the front right-hand side, grasp the roadwheel at the 3 o'clock and 9 o'clock positions and rock gently but firmly. Check for free play or insecurity at the wheel bearings, suspension balljoints, or suspension mountings, pivots and attachments.

□ Now grasp the wheel at the 12 o'clock and 6 o'clock positions and repeat the previous inspection. Spin the wheel, and check for roughness or tightness of the front wheel bearing.

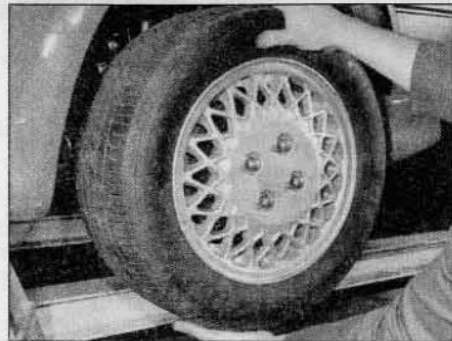

□ If excess free play is suspected at a component pivot point, this can be confirmed by using a large screwdriver or similar tool and levering between the mounting and the component attachment. This will confirm whether the wear is in the pivot bush, its retaining bolt, or in the mounting itself (the bolt holes can often become elongated).

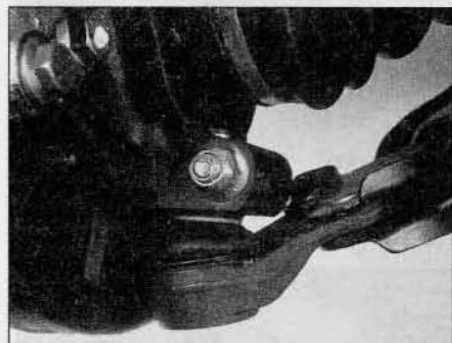

□ Carry out all the above checks at the other front wheel, and then at both rear wheels.

**Springs and shock absorbers**

□ Examine the suspension struts (when applicable) for serious fluid leakage, corrosion, or damage to the casing. Also check the security of the mounting points.

□ If coil springs are fitted, check that the spring ends locate in their seats, and that the spring is not corroded, cracked or broken.

□ If leaf springs are fitted, check that all leaves are intact, that the axle is securely attached to each spring, and that there is no deterioration of the spring eye mountings, bushes, and shackles.

□ The same general checks apply to vehicles fitted with other suspension types, such as torsion bars, hydraulic displacer units, etc. Ensure that all mountings and attachments are secure, that there are no signs of excessive wear, corrosion or damage, and (on hydraulic types) that there are no fluid leaks or damaged pipes.

□ Inspect the shock absorbers for signs of serious fluid leakage. Check for wear of the mounting bushes or attachments, or damage to the body of the unit.

**Driveshafts (fwd vehicles only)**

□ Rotate each front wheel in turn and inspect the constant velocity joint gaiters for splits or damage. Also check that each driveshaft is straight and undamaged.

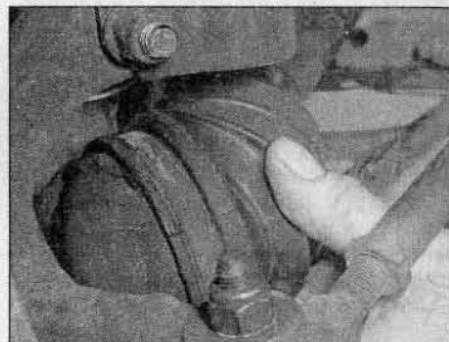
**Braking system**

□ If possible without dismantling, check brake pad wear and disc condition. Ensure that the friction lining material has not worn excessively, (A) and that the discs are not fractured, pitted, scored or badly worn (B).

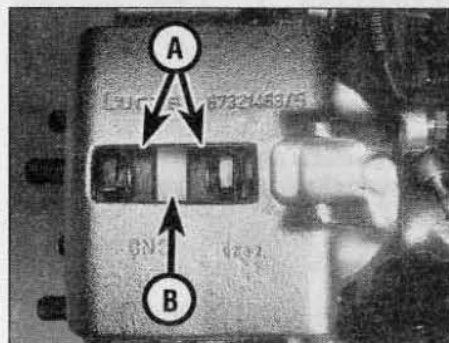

□ Examine all the rigid brake pipes underneath the vehicle, and the flexible hose(s) at the rear. Look for corrosion, chafing or insecurity of the pipes, and for signs of bulging under pressure, chafing, splits or deterioration of the flexible hoses.

□ Look for signs of fluid leaks at the brake calipers or on the brake backplates. Repair or renew leaking components.

□ Slowly spin each wheel, while your assistant depresses and releases the footbrake. Ensure that each brake is operating and does not bind when the pedal is released.



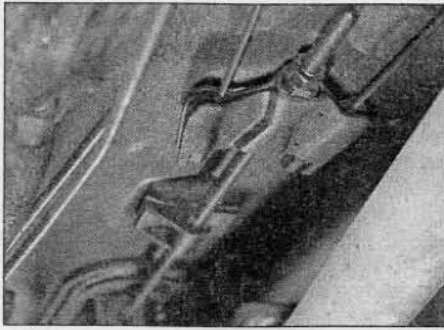

- Examine the handbrake mechanism, checking for frayed or broken cables, excessive corrosion, or wear or insecurity of the linkage. Check that the mechanism works on each relevant wheel, and releases fully, without binding.
- It is not possible to test brake efficiency without special equipment, but a road test can be carried out later to check that the vehicle pulls up in a straight line.

**Fuel and exhaust systems**

- Inspect the fuel tank (including the filler cap), fuel pipes, hoses and unions. All components must be secure and free from leaks.
- Examine the exhaust system over its entire length, checking for any damaged, broken or missing mountings, security of the retaining clamps and rust or corrosion.

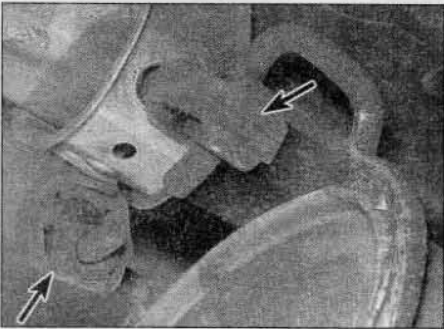

**Wheels and tyres**

- Examine the sidewalls and tread area of each tyre in turn. Check for cuts, tears, lumps, bulges, separation of the tread, and exposure of the ply or cord due to wear or damage. Check that the tyre bead is correctly seated on the wheel rim, that the valve is sound and properly seated, and that the wheel is not distorted or damaged.
- Check that the tyres are of the correct size for the vehicle, that they are of the same size and type on each axle, and that the pressures are correct.
- Check the tyre tread depth. The legal minimum at the time of writing is 1.6 mm over at least three-quarters of the tread width. Abnormal tread wear may indicate incorrect front wheel alignment.

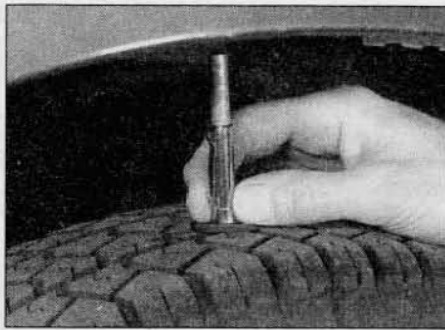

**Body corrosion**

- Check the condition of the entire vehicle structure for signs of corrosion in load-bearing areas. (These include chassis box sections, side sills, cross-members, pillars, and all suspension, steering, braking system and seat belt mountings and anchorages.) Any corrosion which has seriously reduced the thickness of a load-bearing area is likely to cause the vehicle to fail. In this case professional repairs are likely to be needed.
- Damage or corrosion which causes sharp or otherwise dangerous edges to be exposed will also cause the vehicle to fail.

**4 Checks carried out on YOUR VEHICLE'S EXHAUST EMISSION SYSTEM**

**Petrol models**

- Have the engine at normal operating temperature, and make sure that it is in good tune (ignition system in good order, air filter element clean, etc).
- Before any measurements are carried out, raise the engine speed to around 2500 rpm, and hold it at this speed for 20 seconds. Allow the engine speed to return to idle, and watch for smoke emissions from the exhaust tailpipe. If the idle speed is obviously much too high, or if dense blue or clearly-visible black smoke comes from the tailpipe for more than 5 seconds, the vehicle will fail. As a rule of thumb, blue smoke signifies oil being burnt (engine wear) while black smoke signifies unburnt fuel (dirty air cleaner element, or other carburettor or fuel system fault).
- An exhaust gas analyser capable of measuring carbon monoxide (CO) and hydrocarbons (HC) is now needed. If such an instrument cannot be hired or borrowed, a local garage may agree to perform the check for a small fee.

**CO emissions (mixture)**

- At the time of writing, for vehicles first used between 1<sup>st</sup> August 1975 and 31<sup>st</sup> July 1986 (P to C registration), the CO level must not exceed 4.5% by volume. For vehicles first used between 1<sup>st</sup> August 1986 and 31<sup>st</sup> July 1992 (D to J registration), the CO level must not exceed 3.5% by volume. Vehicles first

used after 1<sup>st</sup> August 1992 (K registration) must conform to the manufacturer's specification. The MOT tester has access to a DOT database or emissions handbook, which lists the CO and HC limits for each make and model of vehicle. The CO level is measured with the engine at idle speed, and at "fast idle". The following limits are given as a general guide:

- At idle speed -
  - CO level no more than 0.5%
- At "fast idle" (2500 to 3000 rpm) -
  - CO level no more than 0.3%
  - (Minimum oil temperature 60°C)

- If the CO level cannot be reduced far enough to pass the test (and the fuel and ignition systems are otherwise in good condition) then the carburettor is badly worn, or there is some problem in the fuel injection system or catalytic converter (as applicable).

**HC emissions**

With the CO within limits, HC emissions for vehicles first used between 1<sup>st</sup> August 1975 and 31<sup>st</sup> July 1992 (P to J registration) must not exceed 1200 ppm. Vehicles first used after 1<sup>st</sup> August 1992 (K registration) must conform to the manufacturer's specification. The MOT tester has access to a DOT database or emissions handbook, which lists the CO and HC limits for each make and model of vehicle. The HC level is measured with the engine at "fast idle". The following is given as a general guide:

- At "fast idle" (2500 to 3000 rpm) -
  - HC level no more than 200 ppm
  - (Minimum oil temperature 60°C)

- Excessive HC emissions are caused by incomplete combustion, the causes of which can include oil being burnt, mechanical wear and ignition/fuel system malfunction.

**Diesel models**

The only emission test applicable to Diesel engines is the measuring of exhaust smoke density. The test involves accelerating the engine several times to its maximum unloaded speed.

**Note:** It is of the utmost importance that the engine timing belt is in good condition before the test is carried out.

The limits for Diesel engine exhaust smoke, introduced in September 1995 are: *Vehicles first used before 1<sup>st</sup> August 1979:* Exempt from metered smoke testing, but must not emit "dense blue or clearly visible black smoke for a period of more than 5 seconds at idle" or "dense blue or clearly visible black smoke during acceleration which would obscure the view of other road users".

*Non-turbocharged vehicles first used after 1<sup>st</sup> August 1979: 2.5m<sup>-1</sup>*

*Turbocharged vehicles first used after 1<sup>st</sup> August 1979: 3.0m<sup>-1</sup>*

- Excessive smoke can be caused by a dirty air cleaner element. Otherwise, professional advice may be needed to find the cause.

**Engine**

- Engine fails to rotate when attempting to start
- Engine rotates, but will not start
- Engine difficult to start when cold
- Engine difficult to start when hot
- Starter motor noisy or excessively-rough in engagement
- Engine starts, but stops immediately
- Engine idles erratically
- Engine misfires at idle speed
- Engine misfires throughout the driving speed range
- Engine hesitates on acceleration
- Engine stalls
- Engine lacks power
- Engine backfires
- Oil pressure warning light on with engine running
- Engine runs-on after switching off
- Engine noises

**Cooling system**

- Overheating
- Overcooling
- External coolant leakage
- Internal coolant leakage
- Corrosion

**Fuel and exhaust systems**

- Excessive fuel consumption
- Fuel leakage and/or fuel odour
- Excessive noise or fumes from exhaust system

**Clutch**

- Pedal travels to floor – no pressure or very little resistance
- Clutch fails to disengage (unable to select gears)
- Clutch slips (engine speed rises, with no increase in vehicle speed)
- Judder as clutch is engaged
- Noise when depressing or releasing clutch pedal

**Transmission**

- Noisy in neutral with engine running
- Noisy in one particular gear
- Difficulty engaging gears
- Jumps out of gear
- Vibration
- Lubricant leaks

**Driveshafts**

- Clicking or knocking noise on turns (at slow speed on full-lock)
- Vibration when accelerating or decelerating

**Braking system**

- Vehicle pulls to one side under braking
- Noise (grinding or high-pitched squeal) when brakes applied
- Excessive brake pedal travel
- Brake pedal feels spongy when depressed
- Excessive brake pedal effort required to stop vehicle
- Judder felt through brake pedal or steering wheel when braking
- Brakes binding
- Rear wheels locking under normal braking

**Suspension and steering systems**

- Vehicle pulls to one side
- Wheel wobble and vibration
- Excessive pitching and/or rolling around corners, or during braking
- Wandering or general instability
- Excessively-stiff steering
- Excessive play in steering
- Lack of power assistance
- Tyre wear excessive

**Electrical system**

- Battery will not hold a charge for more than a few days
- Ignition/no-charge warning light stays on with engine running
- Ignition/no-charge warning light fails to come on
- Lights inoperative
- Instrument readings inaccurate or erratic
- Horn inoperative, or unsatisfactory in operation
- Windscreen/tailgate wipers failed, or unsatisfactory in operation
- Windscreen/tailgate washers failed, or unsatisfactory in operation
- Electric windows inoperative, or unsatisfactory in operation
- Central locking system inoperative, or unsatisfactory in operation

**Introduction**

The vehicle owner who does his or her own maintenance according to the recommended service schedules should not have to use this section of the manual very often. Modern component reliability is such that, provided those items subject to wear or deterioration are inspected or renewed at the specified intervals, sudden failure is comparatively rare. Faults do not usually just happen as a result of sudden failure, but develop over a period of time. Major mechanical failures in particular are usually preceded by characteristic

symptoms over hundreds or even thousands of miles. Those components which do occasionally fail without warning are often small and easily carried in the vehicle.

With any fault-finding, the first step is to decide where to begin investigations. Sometimes this is obvious, but on other occasions, a little detective work will be necessary. The owner who makes half a dozen haphazard adjustments or replacements may be successful in curing a fault (or its symptoms), but will be none the

wiser if the fault recurs, and ultimately may have spent more time and money than was necessary. A calm and logical approach will be found to be more satisfactory in the long run. Always take into account any warning signs or abnormalities that may have been noticed in the period preceding the fault – power loss, high or low gauge readings, unusual smells, etc – and remember that failure of components such as fuses or spark plugs may only be pointers to some underlying fault.



The pages which follow provide an easy-reference guide to the more common problems which may occur during the operation of the vehicle. These problems and their possible causes are grouped under headings denoting various components or systems, such as Engine, Cooling system, etc. The general Chapter which deals with the problem is also shown in brackets; refer to the relevant part of that Chapter for system-specific information. Whatever the fault, certain basic principles apply. These are as follows:

*Verify the fault.* This is simply a matter of being sure that you know what the symptoms are before starting work. This is particularly

important if you are investigating a fault for someone else, who may not have described it very accurately.

*Don't overlook the obvious.* For example, if the vehicle won't start, is there fuel in the tank? (Don't take anyone else's word on this particular point, and don't trust the fuel gauge either!) If an electrical fault is indicated, look for loose or broken wires before digging out the test gear.

*Cure the disease, not the symptom.* Substituting a flat battery with a fully-charged one will get you off the hard shoulder, but if the underlying cause is not attended to, the new battery will go the same way. Similarly,

changing oil-fouled spark plugs (petrol models) for a new set will get you moving again, but remember that the reason for the fouling (if it wasn't simply an incorrect grade of plug) will have to be found and corrected.

*Don't take anything for granted.* Particularly, don't forget that a 'new' component may itself be defective (especially if it's been rattling around in the boot for months), and don't leave components out of a fault diagnosis sequence just because they are new or recently-fitted. When you do finally diagnose a difficult fault, you'll probably realise that all the evidence was there from the start.

## Engine

### Engine fails to rotate when attempting to start

- Battery terminal connections loose or corroded (*Weekly checks*).
- Battery discharged or faulty (Chapter 5).
- Broken, loose or disconnected wiring in the starting circuit (Chapter 5).
- Defective starter motor (Chapter 5).
- Starter pinion or flywheel ring gear teeth loose or broken (Chapter 2 and 5).
- Engine earth strap broken or disconnected (Chapter 5 and 12).

### Engine rotates, but will not start

- Fuel tank empty.
- Battery discharged (engine rotates slowly) (Chapter 5).
- Battery terminal connections loose or corroded (*Weekly checks*).
- Worn, faulty or incorrectly-gapped spark plugs – petrol models (Chapter 1).
- Pre/post-heating system faulty – diesel models (Chapter 5).
- Engine management system fault (Chapter 4).
- Air in fuel system – diesel models (Chapter 4).
- High pressure fuel system fault – diesel models (Chapter 4).
- Low cylinder compressions (Chapter 2).
- Major mechanical failure (eg camshaft drive) (Chapter 2).

### Engine difficult to start when cold

- Battery discharged (Chapter 5).
- Battery terminal connections loose or corroded (*Weekly checks*).
- Worn, faulty or incorrectly-gapped spark plugs – petrol models (Chapter 1).
- Pre/post-heating system faulty – diesel models (Chapter 5).
- Engine management system fault (Chapter 4).
- High pressure fuel system fault – diesel models (Chapter 4).
- Low cylinder compressions (Chapter 2).

### Engine difficult to start when hot

- Engine management system fault (Chapter 4).
- High pressure fuel system fault – diesel models (Chapter 4).
- Low cylinder compressions (Chapter 2).

### Starter motor noisy or excessively-rough in engagement

- Starter pinion or flywheel ring gear teeth loose or broken (Chapter 2 and 5).
- Starter motor mounting bolts loose or missing (Chapter 5).
- Defective starter motor (Chapter 5).

### Engine starts, but stops immediately

- Vacuum leak at the throttle housing/inlet manifold – petrol models (Chapter 4).
- Engine management system fault (Chapter 4).
- Air in fuel system – diesel models (Chapter 4).
- High pressure fuel system fault – diesel models (Chapter 4).

### Engine idles erratically

- Vacuum leak at the throttle housing/inlet manifold – petrol models (Chapter 4).
- Worn, faulty or incorrectly-gapped spark plugs – petrol models (Chapter 1).
- Engine management system fault (Chapter 4).
- Air in fuel system – diesel models (Chapter 4).
- High pressure fuel system fault – diesel models (Chapter 4).
- Uneven or low cylinder compressions (Chapter 2).
- Camshaft lobes worn (Chapter 2).
- Timing belt incorrectly fitted (Chapter 2).

### Engine misfires at idle speed

- Worn, faulty or incorrectly-gapped spark plugs – petrol models (Chapter 1).
- Vacuum leak at the throttle housing/inlet manifold – petrol models (Chapter 4).
- Engine management system fault (Chapter 4).
- High pressure fuel system fault – diesel models (Chapter 4).
- Uneven or low cylinder compressions (Chapter 2).
- Disconnected, leaking, or perished crankcase ventilation hoses (Chapter 4).

### Engine misfires throughout the driving speed range

- Fuel filter blocked (Chapter 1).
- Fuel pump faulty – petrol models (Chapter 4).
- Fuel tank vent blocked, or fuel pipes restricted (Chapter 4).
- Worn, faulty or incorrectly-gapped spark plugs – petrol models (Chapter 1).
- Vacuum leak at the throttle housing/inlet manifold – petrol models (Chapter 4).
- Engine management system fault (Chapter 4).
- High pressure fuel system fault – diesel models (Chapter 4).
- Faulty ignition HT coil – petrol models (Chapter 5).
- Uneven or low cylinder compressions (Chapter 2).



## Engine (continued)

### Engine hesitates on acceleration

- Worn, faulty or incorrectly-gapped spark plugs – petrol models (Chapter 1).
- Vacuum leak at the throttle housing/inlet manifold – petrol models (Chapter 4).
- Engine management system fault (Chapter 4).
- High pressure fuel system fault – diesel models (Chapter 4).

### Engine stalls

- Fuel filter blocked (Chapter 1).
- Fuel pump faulty – petrol models (Chapter 4).
- Fuel tank vent blocked, or fuel pipes restricted (Chapter 4).
- Worn, faulty or incorrectly-gapped spark plugs – petrol models (Chapter 1).
- Vacuum leak at the throttle housing/inlet manifold – petrol models (Chapter 4).
- Engine management system fault (Chapter 4).
- High pressure fuel system fault – diesel models (Chapter 4).

### Engine lacks power

- Timing belt incorrectly fitted (Chapter 2).
- Fuel filter blocked (Chapter 1).
- Fuel pump faulty – petrol models (Chapter 4).
- Uneven or low cylinder compressions (Chapter 2).
- Worn, faulty or incorrectly-gapped spark plugs – petrol models (Chapter 1).
- Vacuum leak at the throttle housing/inlet manifold – petrol models (Chapter 4).
- Engine management system fault (Chapter 4).
- High pressure fuel system fault – diesel models (Chapter 4).
- Brakes binding (Chapter 1 and 9).
- Clutch slipping (Chapter 6).

### Engine backfires

- Timing belt incorrectly fitted (Chapter 2).
- Vacuum leak at the throttle housing/inlet manifold – petrol models (Chapter 4).
- Engine management system fault (Chapter 4).

### Oil pressure warning light on with engine running

- Low oil level, or incorrect oil grade (*Weekly checks*).

- Faulty oil pressure warning light switch (Chapter 5).
- Worn engine bearings and/or oil pump (Chapter 2).
- High engine operating temperature (Chapter 3).
- Oil pressure relief valve defective (Chapter 2).
- Oil pick-up strainer clogged (Chapter 2).

### Engine runs-on after switching off

- Excessive carbon build-up in engine (Chapter 2).
- High engine operating temperature (Chapter 3).
- Engine management system fault (Chapter 4).
- High pressure fuel system fault – diesel models (Chapter 4).

### Engine noises

#### Pre-ignition (pinking) or knocking during acceleration or under load

- Engine management system fault (Chapter 4).
- Incorrect grade of spark plug – petrol models (Chapter 1).
- Incorrect grade of fuel – petrol models (Chapter 4).
- Vacuum leak at the throttle housing/inlet manifold – petrol models (Chapter 4).
- Excessive carbon build-up in engine (Chapter 2).

#### Whistling or wheezing noises

- Leaking inlet manifold or throttle housing gasket – petrol models (Chapter 4).
- Leaking vacuum hose (Chapter 4 and 9).
- Blowing cylinder head gasket (Chapter 2).

#### Tapping or rattling noises

- Worn valve gear or camshaft (Chapter 2).
- Ancillary component fault (coolant pump, alternator, etc) (Chapters 3, 5, etc).

#### Knocking or thumping noises

- Worn big-end bearings (regular heavy knocking, perhaps less under load) (Chapter 2).
- Worn main bearings (rumbling and knocking, perhaps worsening under load) (Chapter 2).
- Piston slap (most noticeable when cold) (Chapter 2).
- Ancillary component fault (coolant pump, alternator, etc) (Chapters 3, 5, etc).

## Cooling system

### Overheating

- Insufficient coolant in system (*Weekly checks*).
- Thermostat faulty (stuck closed) (Chapter 3).
- Radiator core blocked, or grille restricted (Chapter 3).
- Electric cooling fan or sensor faulty (Chapter 3).
- Pressure cap faulty (Chapter 3).
- Inaccurate temperature gauge/sensor (Chapter 3).
- Airlock in cooling system (Chapter 1).
- Engine management system fault (Chapter 4).

### Overcooling

- Thermostat faulty (stuck open) (Chapter 3).
- Inaccurate temperature gauge/sensor (Chapter 3).

### External coolant leakage

- Deteriorated or damaged hoses or hose clips (Chapter 1).
- Radiator core or heater matrix leaking (Chapter 3).
- Pressure cap faulty (Chapter 3).
- Coolant pump leaking (Chapter 3).
- Boiling due to overheating (Chapter 3).
- Core plug leaking (Chapter 2).

### Internal coolant leakage

- Leaking cylinder head gasket (Chapter 2).
- Cracked cylinder head or cylinder bore (Chapter 2).

### Corrosion

- Infrequent draining and flushing (Chapter 1).
- Incorrect coolant mixture or inappropriate coolant type (Chapter 1).

## Fuel and exhaust systems

### Excessive fuel consumption

- Air filter element dirty or clogged (Chapter 1).
- Engine management system fault (Chapter 4).
- High pressure fuel system fault – diesel models (Chapter 4).
- Tyres under-inflated (*Weekly checks*).
- Brakes binding (Chapters 1 and 9).

### Fuel leakage and/or fuel odour

- Damaged or corroded fuel tank, pipes or connections (Chapter 4).

### Excessive noise or fumes from exhaust system

- Leaking exhaust system or manifold joints (Chapters 1 and 4).
- Leaking, corroded or damaged silencers or pipe (Chapters 1 and 4).
- Broken mountings causing body or suspension contact (Chapters 1 and 4).

## Clutch

### Pedal travels to floor – no pressure or very little resistance

- Broken clutch cable (Chapter 6).
- Broken clutch release bearing or fork (Chapter 6).
- Broken diaphragm spring in clutch pressure plate (Chapter 6).

### Clutch fails to disengage (unable to select gears)

- Clutch disc sticking on gearbox input shaft splines (Chapter 6).
- Clutch disc sticking to flywheel or pressure plate (Chapter 6).
- Faulty pressure plate assembly (Chapter 6).
- Clutch release mechanism worn or incorrectly assembled (Chapter 6).

### Clutch slips (engine speed rises, with no increase in vehicle speed)

- Clutch disc linings excessively worn (Chapter 6).
- Clutch disc linings contaminated with oil or grease (Chapter 6).
- Faulty pressure plate or weak diaphragm spring (Chapter 6).

### Judder as clutch is engaged

- Clutch disc linings contaminated with oil or grease (Chapter 6).
- Clutch disc linings excessively worn (Chapter 6).
- Faulty or distorted pressure plate or diaphragm spring (Chapter 6).
- Worn or loose engine or gearbox mountings (Chapter 2 or ).
- Clutch disc hub or gearbox input shaft splines worn (Chapter 6).

### Noise when depressing or releasing clutch pedal

- Worn clutch release bearing (Chapter 6).
- Worn or dry clutch pedal bushes (Chapter 6).
- Faulty pressure plate assembly (Chapter 6).
- Pressure plate diaphragm spring broken (Chapter 6).
- Broken clutch disc cushioning springs (Chapter 6).

## Transmission

### Noisy in neutral with engine running

- Input shaft bearings worn (noise apparent with clutch pedal released, but not when depressed) (Chapter 7).\*
- Clutch release bearing worn (noise apparent with clutch pedal depressed, possibly less when released) (Chapter 6).

### Noisy in one particular gear

- Worn, damaged or chipped gear teeth (Chapter 7).\*

### Difficulty engaging gears

- Clutch fault (Chapter 6).
- Worn or damaged gear selector mechanism (Chapter 7).
- Worn synchroniser units (Chapter 7).\*

### Jumps out of gear

- Worn or damaged gear selector mechanism (Chapter 7).
- Worn synchroniser units (Chapter 7).\*
- Worn selector forks (Chapter 7).\*

### Vibration

- Lack of oil (Chapter 1 and 7).
- Worn bearings (Chapter 7).\*

### Lubricant leaks

- Leaking differential output oil seal (Chapter 7).
- Leaking housing joint (Chapter 7).\*
- Leaking input shaft oil seal (Chapter 7).

*\*Although the corrective action necessary to remedy the symptoms described is beyond the scope of the home mechanic, the above information should be helpful in isolating the cause of the condition, so that the owner can communicate clearly with a professional mechanic.*

## Driveshafts

### Clicking or knocking noise on turns (at slow speed on full-lock)

- Lack of constant velocity joint lubricant, possibly due to damaged gaiter (Chapter 8).
- Worn outer constant velocity joint (Chapter 8).

## Braking system

**Note:** Before assuming that a brake problem exists, make sure that the tyres are in good condition and correctly inflated, that the front wheel alignment is correct, and that the vehicle is not loaded with weight in an unequal manner. Apart from checking the condition of all pipe and hose connections, any faults occurring on the anti-lock braking system should be referred to a Peugeot/Citroën dealer for diagnosis.

### Vehicle pulls to one side under braking

- Worn, defective, damaged or contaminated brake pads/shoes on one side (Chapter 9).
- Seized or partially-seized front brake caliper (Chapter 9).
- A mixture of brake pad/shoe materials fitted between sides (Chapter 9).
- Brake caliper mounting bolts loose (Chapter 9).
- Worn or damaged steering or suspension components (Chapter 1 and 10).

### Noise (grinding or high-pitched squeal) when brakes applied

- Brake pad/shoe material worn down to metal backing (Chapter 1 and 9).
- Excessive corrosion of brake disc/drum. May be apparent after the vehicle has been standing for some time (Chapter 9).
- Foreign object (stone chipping, etc) trapped between brake disc and shield (Chapter 9).

### Excessive brake pedal travel

- Faulty master cylinder (Chapter 9).
- Air in hydraulic system (Chapter 9).
- Faulty vacuum servo unit (Chapter 9).

### Brake pedal feels spongy when depressed

- Air in hydraulic system (Chapter 9).

### Vibration when accelerating or decelerating

- Worn inner constant velocity joint (Chapter 8).
- Bent or distorted driveshaft (Chapter 8).
- Worn intermediate bearing (where fitted) (Chapter 8).

- Deteriorated flexible rubber brake hoses (Chapter 1 and 9).
- Master cylinder mounting nuts loose (Chapter 9).
- Faulty master cylinder (Chapter 9).

### Excessive brake pedal effort required to stop vehicle

- Faulty vacuum servo unit (Chapter 9).
- Disconnected, damaged or insecure brake servo vacuum hose (Chapter 9).
- Primary or secondary hydraulic circuit failure (Chapter 9).
- Seized brake caliper or wheel cylinder (Chapter 9).
- Brake pads/shoes incorrectly fitted (Chapter 9).
- Incorrect grade of brake pads/shoes fitted (Chapter 9).
- Brake pads/shoes contaminated (Chapter 9).

### Judder felt through brake pedal or steering wheel when braking

- Excessive run-out or distortion of discs or drums (Chapters 9).
- Brake pads/shoes worn (Chapters 1 and 9).
- Brake caliper mounting bolts loose (Chapter 9).
- Wear in suspension or steering components or mountings (Chapter 1 and 10).

### Brakes binding

- Seized brake caliper or wheel cylinder (Chapter 9).
- Incorrectly-adjusted handbrake mechanism (Chapter 9).
- Faulty master cylinder (Chapter 9).

### Rear wheels locking under normal braking

- Rear brake shoes contaminated (Chapter 1 and 9).
- Faulty or incorrectly adjusted rear brake pressure-regulating valve – models without ABS (Chapter 9).
- ABS system fault (Chapter 9).



## Suspension and steering

**Note:** Before diagnosing suspension or steering faults, be sure that the trouble is not due to incorrect tyre pressures, mixtures of tyre types, or binding brakes.

### Vehicle pulls to one side

- Defective tyre (*Weekly checks*).
- Excessive wear in suspension or steering components (Chapter 1 and 10).
- Incorrect front wheel alignment (Chapter 10).
- Damage to steering or suspension components (Chapter 1 and 10).

### Wheel wobble and vibration

- Front roadwheels out of balance (vibration felt mainly through the steering wheel) (*Weekly checks*).
- Rear roadwheels out of balance (vibration felt throughout the vehicle) (*Weekly checks*).
- Roadwheels damaged or distorted (*Weekly checks*).
- Faulty or damaged tyre (*Weekly checks*).
- Worn steering or suspension joints, bushes or components (Chapter 1 and 10).
- Wheel bolts loose (Chapter 1 and 10).

### Excessive pitching and/or rolling around corners, or during braking

- Defective shock absorbers (Chapter 1 and 10).
- Broken or weak spring and/or suspension part (Chapter 1 and 10).
- Worn or damaged anti-roll bar or mountings (Chapter 10).

### Wandering or general instability

- Incorrect front wheel alignment (Chapter 10).
- Worn steering or suspension joints, bushes or components (Chapter 1 and 10).
- Roadwheels out of balance (*Weekly checks*).
- Faulty or damaged tyre (*Weekly checks*).
- Wheel bolts loose (Chapter 1 and 10).
- Defective shock absorbers (Chapter 1 and 10).

### Excessively-stiff steering

- Broken or incorrectly-adjusted auxiliary drivebelt (Chapter 1).
- Faulty power steering pump (Chapter 10).

- Seized track rod end balljoint or suspension balljoint (Chapter 1 and 10).
- Incorrect front wheel alignment (Chapter 10).
- Steering rack or column bent or damaged (Chapter 10).

### Excessive play in steering

- Worn steering column universal joint (Chapter 10).
- Worn steering track rod end balljoints (Chapter 1 and 10).
- Worn steering rack (Chapter 10).
- Worn steering or suspension joints, bushes or components (Chapter 1 and 10).

### Lack of power assistance

- Broken or incorrectly-adjusted auxiliary drivebelt (Chapter 1).
- Faulty power steering pump (Chapter 10).
- Restriction in power steering fluid hoses (Chapter 1).
- Faulty steering rack (Chapter 10).

### Tyre wear excessive

#### Tyre treads exhibit feathered edges

- Incorrect toe setting (Chapter 10).

#### Tyres worn in centre of tread

- Tyres over-inflated (*Weekly checks*).

#### Tyres worn on inside and outside edges

- Tyres under-inflated (*Weekly checks*).

#### Tyres worn on inside or outside edges

- Incorrect camber/castor angles (wear on one edge only) (Chapter 10).
- Worn steering or suspension joints, bushes or components (Chapter 1 and 10).
- Excessively-hard cornering.
- Accident damage.

#### Tyres worn unevenly

- Tyres/wheels out of balance (*Weekly checks*).
- Excessive wheel or tyre run-out (Chapter 1).
- Worn shock absorbers (Chapter 1 and 10).
- Faulty tyre (*Weekly checks*).

## Electrical system

**Note:** For problems associated with the starting system, refer to the faults listed under 'Engine' earlier in this Section.

### Battery won't hold a charge for more than a few days

- Battery defective internally (Chapter 5).
- Battery terminal connections loose or corroded (*Weekly checks*).
- Auxiliary drivebelt broken, worn or incorrectly adjusted (Chapter 1).
- Alternator not charging at correct output (Chapter 5).
- Alternator or voltage regulator faulty (Chapter 5).
- Short-circuit causing continual battery drain (Chapter 5 and 12).

### Ignition/no-charge warning light stays on with engine running

- Auxiliary drivebelt broken, worn, or incorrectly adjusted (Chapter 1).
- Internal fault in alternator or voltage regulator (Chapter 5).
- Broken, disconnected, or loose wiring in charging circuit (Chapter 5).

### Ignition/no-charge warning light fails to come on

- Warning light bulb blown (Chapter 12).
- Broken, disconnected, or loose wiring in warning light circuit (Chapter 12).
- Alternator faulty (Chapter 5).

### Lights inoperative

- Bulb blown (Chapter 12).
- Corrosion of bulb or bulbholder contacts (Chapter 12).
- Blown fuse (Chapter 12).
- Faulty relay (Chapter 12).
- Broken, loose, or disconnected wiring (Chapter 12).
- Faulty switch (Chapter 12).

### Instrument readings inaccurate or erratic

#### Fuel or temperature gauges give no reading

- Faulty gauge sensor/sender unit (Chapter 3 or 4).
- Wiring open-circuit (Chapter 12).
- Faulty gauge (Chapter 12).
- Built-in Systems Interface (BSI) faulty (Chapter 12).

#### Fuel or temperature gauges give continuous maximum reading

- Faulty gauge sensor/sender unit (Chapter 3 or 4).
- Wiring short-circuit (Chapter 12).
- Faulty gauge (Chapter 12).
- Built-in Systems Interface (BSI) faulty (Chapter 12).

### Horn inoperative, or unsatisfactory in operation

#### Horn operates all the time

- Horn push either earthed or stuck down (Chapter 12).
- Horn cable-to-horn push earthed (Chapter 12).

#### Horn fails to operate

- Blown fuse (Chapter 12).
- Cable or cable connections loose, broken or disconnected (Chapter 12).
- Faulty horn (Chapter 12).

#### Horn emits intermittent or unsatisfactory sound

- Cable connections loose (Chapter 12).
- Horn mountings loose (Chapter 12).
- Faulty horn (Chapter 12).

### Windscreen/tailgate wipers failed, or unsatisfactory in operation

#### Wipers fail to operate, or operate very slowly

- Wiper blades stuck to screen, or linkage seized or binding (Chapter 1 and 12).

- Blown fuse (Chapter 12).
- Cable or cable connections loose, broken or disconnected (Chapter 12).
- Built-in Systems Interface (BSI) faulty (Chapter 12).
- Faulty wiper motor (Chapter 12).

#### Wiper blades sweep over too large or too small an area of the glass

- Wiper arms incorrectly positioned on spindles (Chapter 12).
- Excessive wear of wiper linkage (Chapter 12).
- Wiper motor or linkage mountings loose or insecure (Chapter 12).

#### Wiper blades fail to clean the glass effectively

- Wiper blade rubbers worn or perished (*Weekly checks*).
- Wiper arm tension springs broken, or arm pivots seized (Chapter 12).
- Insufficient windscreen washer additive to adequately remove road film (*Weekly checks*).

### Windscreen/tailgate washers failed, or unsatisfactory in operation

#### One or more washer jets inoperative

- Blocked washer jet (*Weekly checks*).
- Disconnected, kinked or restricted fluid hose (Chapter 12).
- Insufficient fluid in washer reservoir (*Weekly checks*).

#### Washer pump fails to operate

- Broken or disconnected wiring or connections (Chapter 12).
- Blown fuse (Chapter 12).
- Faulty washer switch (Chapter 12).
- Faulty washer pump (Chapter 12).

### Electric windows inoperative, or unsatisfactory in operation

#### Window glass will only move in one direction

- Faulty switch (Chapter 12).

#### Window glass slow to move

- Regulator seized or damaged, or in need of lubricant (Chapter 11).
- Door internal components or trim fouling regulator (Chapter 11).
- Faulty motor (Chapter 11).

#### Window glass fails to move

- Blown fuse (Chapter 12).
- Broken or disconnected wiring or connections (Chapter 12).
- Faulty motor (Chapter 11).
- Built-in Systems Interface (BSI) faulty (Chapter 12).

### Central locking system inoperative, or unsatisfactory in operation

#### Complete system failure

- Blown fuse (Chapter 12).
- Broken or disconnected wiring or connections (Chapter 12).
- Built-in Systems Interface (BSI) faulty (Chapter 12).

#### Door/tailgate locks but will not unlock, or unlocks but will not lock

- Broken or disconnected link rod(s) (Chapter 11).
- Faulty lock motor (Chapter 11).

#### One lock fails to operate

- Broken or disconnected wiring or connections (Chapter 12).
- Faulty lock motor (Chapter 11).
- Broken, binding or disconnected link rod(s) (Chapter 11).

**A** The first part of the text discusses the importance of the study and the methods used. It mentions that the study was conducted in a laboratory setting and that the results were compared to those of a previous study. The text also mentions that the study was funded by the National Science Foundation.

The second part of the text describes the experimental setup and the procedures used. It mentions that the study was conducted in a laboratory setting and that the results were compared to those of a previous study. The text also mentions that the study was funded by the National Science Foundation.

The third part of the text discusses the results of the study and the conclusions drawn. It mentions that the study found that the results were similar to those of a previous study. The text also mentions that the study was funded by the National Science Foundation.

The fourth part of the text discusses the implications of the study and the future research. It mentions that the study has implications for the field of research and that future research should be conducted in this area. The text also mentions that the study was funded by the National Science Foundation.

The fifth part of the text discusses the limitations of the study and the strengths. It mentions that the study has some limitations and that the results should be interpreted with caution. The text also mentions that the study was funded by the National Science Foundation.

The sixth part of the text discusses the acknowledgments and the references. It mentions that the study was supported by the National Science Foundation and that the authors would like to thank the reviewers for their comments. The text also lists the references used in the study.

The seventh part of the text discusses the conclusions and the future research. It mentions that the study has implications for the field of research and that future research should be conducted in this area. The text also mentions that the study was funded by the National Science Foundation.

The eighth part of the text discusses the implications of the study and the future research. It mentions that the study has implications for the field of research and that future research should be conducted in this area. The text also mentions that the study was funded by the National Science Foundation.

The ninth part of the text discusses the implications of the study and the future research. It mentions that the study has implications for the field of research and that future research should be conducted in this area. The text also mentions that the study was funded by the National Science Foundation.

The tenth part of the text discusses the implications of the study and the future research. It mentions that the study has implications for the field of research and that future research should be conducted in this area. The text also mentions that the study was funded by the National Science Foundation.

The eleventh part of the text discusses the implications of the study and the future research. It mentions that the study has implications for the field of research and that future research should be conducted in this area. The text also mentions that the study was funded by the National Science Foundation.

The twelfth part of the text discusses the implications of the study and the future research. It mentions that the study has implications for the field of research and that future research should be conducted in this area. The text also mentions that the study was funded by the National Science Foundation.





## A

**ABS (Anti-lock brake system)** A system, usually electronically controlled, that senses incipient wheel lockup during braking and relieves hydraulic pressure at wheels that are about to skid.

**Air bag** An inflatable bag hidden in the steering wheel (driver's side) or the dash or glovebox (passenger side). In a head-on collision, the bags inflate, preventing the driver and front passenger from being thrown forward into the steering wheel or windscreen.

**Air cleaner** A metal or plastic housing, containing a filter element, which removes dust and dirt from the air being drawn into the engine.

**Air filter element** The actual filter in an air cleaner system, usually manufactured from pleated paper and requiring renewal at regular intervals.

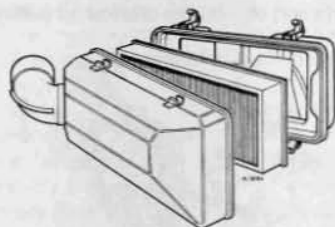

Air filter

**Allen key** A hexagonal wrench which fits into a recessed hexagonal hole.

**Alligator clip** A long-nosed spring-loaded metal clip with meshing teeth. Used to make temporary electrical connections.

**Alternator** A component in the electrical system which converts mechanical energy from a drivebelt into electrical energy to charge the battery and to operate the starting system, ignition system and electrical accessories.

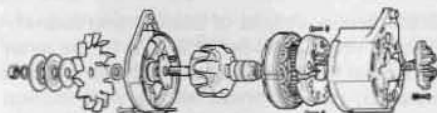

Alternator (exploded view)

**Ampere (amp)** A unit of measurement for the flow of electric current. One amp is the amount of current produced by one volt acting through a resistance of one ohm.

**Anaerobic sealer** A substance used to prevent bolts and screws from loosening. Anaerobic means that it does not require oxygen for activation. The Loctite brand is widely used.

**Antifreeze** A substance (usually ethylene glycol) mixed with water, and added to a vehicle's cooling system, to prevent freezing of the coolant in winter. Antifreeze also contains chemicals to inhibit corrosion and the formation of rust and other deposits that

would tend to clog the radiator and coolant passages and reduce cooling efficiency.

**Anti-seize compound** A coating that reduces the risk of seizing on fasteners that are subjected to high temperatures, such as exhaust manifold bolts and nuts.



Anti-seize compound

**Asbestos** A natural fibrous mineral with great heat resistance, commonly used in the composition of brake friction materials. Asbestos is a health hazard and the dust created by brake systems should never be inhaled or ingested.

**Axle** A shaft on which a wheel revolves, or which revolves with a wheel. Also, a solid beam that connects the two wheels at one end of the vehicle. An axle which also transmits power to the wheels is known as a live axle.

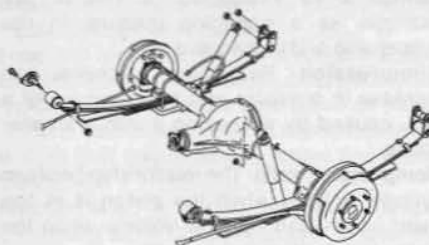

Axle assembly

**Axleshaft** A single rotating shaft, on either side of the differential, which delivers power from the final drive assembly to the drive wheels. Also called a driveshaft or a halfshaft.

## B

**Ball bearing** An anti-friction bearing consisting of a hardened inner and outer race with hardened steel balls between two races.



Bearing

**Bearing** The curved surface on a shaft or in a bore, or the part assembled into either, that permits relative motion between them with minimum wear and friction.

**Big-end bearing** The bearing in the end of the connecting rod that's attached to the crankshaft.

**Bleed nipple** A valve on a brake wheel cylinder, caliper or other hydraulic component that is opened to purge the hydraulic system of air. Also called a bleed screw.

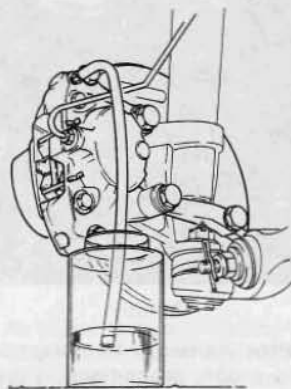

Brake bleeding

**Brake bleeding** Procedure for removing air from lines of a hydraulic brake system.

**Brake disc** The component of a disc brake that rotates with the wheels.

**Brake drum** The component of a drum brake that rotates with the wheels.

**Brake linings** The friction material which contacts the brake disc or drum to retard the vehicle's speed. The linings are bonded or riveted to the brake pads or shoes.

**Brake pads** The replaceable friction pads that pinch the brake disc when the brakes are applied. Brake pads consist of a friction material bonded or riveted to a rigid backing plate.

**Brake shoe** The crescent-shaped carrier to which the brake linings are mounted and which forces the lining against the rotating drum during braking.

**Braking systems** For more information on braking systems, consult the *Haynes Automotive Brake Manual*.

**Breaker bar** A long socket wrench handle providing greater leverage.

**Bulkhead** The insulated partition between the engine and the passenger compartment.

## C

**Caliper** The non-rotating part of a disc-brake assembly that straddles the disc and carries the brake pads. The caliper also contains the hydraulic components that cause the pads to pinch the disc when the brakes are applied. A caliper is also a measuring tool that can be set to measure inside or outside dimensions of an object.

**Camshaft** A rotating shaft on which a series of cam lobes operate the valve mechanisms. The camshaft may be driven by gears, by sprockets and chain or by sprockets and a belt.

**Canister** A container in an evaporative emission control system; contains activated charcoal granules to trap vapours from the fuel system.

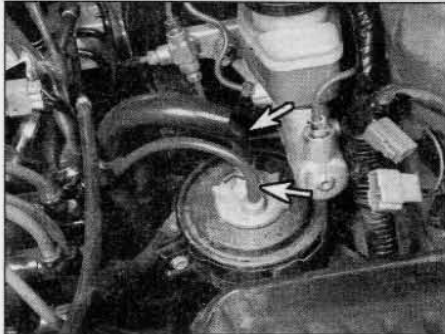

Canister

**Carburettor** A device which mixes fuel with air in the proper proportions to provide a desired power output from a spark ignition internal combustion engine.

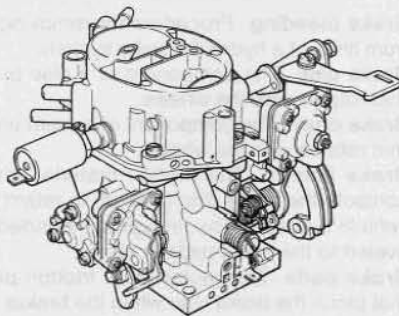

Carburettor

**Castellated** Resembling the parapets along the top of a castle wall. For example, a castellated balljoint stud nut.

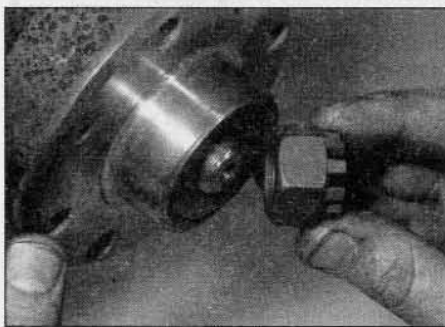

Castellated nut

**Castor** In wheel alignment, the backward or forward tilt of the steering axis. Castor is positive when the steering axis is inclined rearward at the top.

**Catalytic converter** A silencer-like device in the exhaust system which converts certain pollutants in the exhaust gases into less harmful substances.

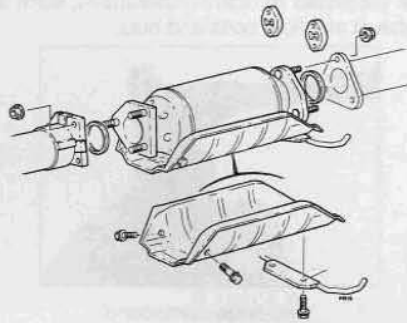

Catalytic converter

**Circlip** A ring-shaped clip used to prevent endwise movement of cylindrical parts and shafts. An internal circlip is installed in a groove in a housing; an external circlip fits into a groove on the outside of a cylindrical piece such as a shaft.

**Clearance** The amount of space between two parts. For example, between a piston and a cylinder, between a bearing and a journal, etc.

**Coil spring** A spiral of elastic steel found in various sizes throughout a vehicle, for example as a springing medium in the suspension and in the valve train.

**Compression** Reduction in volume, and increase in pressure and temperature, of a gas, caused by squeezing it into a smaller space.

**Compression ratio** The relationship between cylinder volume when the piston is at top dead centre and cylinder volume when the piston is at bottom dead centre.

**Constant velocity (CV) joint** A type of universal joint that cancels out vibrations caused by driving power being transmitted through an angle.

**Core plug** A disc or cup-shaped metal device inserted in a hole in a casting through which core was removed when the casting was formed. Also known as a freeze plug or expansion plug.

**Crankcase** The lower part of the engine block in which the crankshaft rotates.

**Crankshaft** The main rotating member, or shaft, running the length of the crankcase, with offset "throws" to which the connecting rods are attached.

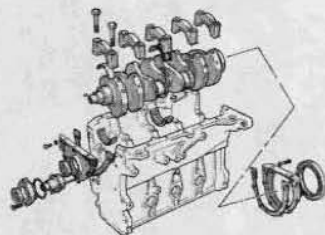

Crankshaft assembly

**Crocodile clip** See Alligator clip

## D

**Diagnostic code** Code numbers obtained by accessing the diagnostic mode of an engine management computer. This code can be used to determine the area in the system where a malfunction may be located.

**Disc brake** A brake design incorporating a rotating disc onto which brake pads are squeezed. The resulting friction converts the energy of a moving vehicle into heat.

**Double-overhead cam (DOHC)** An engine that uses two overhead camshafts, usually one for the intake valves and one for the exhaust valves.

**Drivebelt(s)** The belt(s) used to drive accessories such as the alternator, water pump, power steering pump, air conditioning compressor, etc. off the crankshaft pulley.

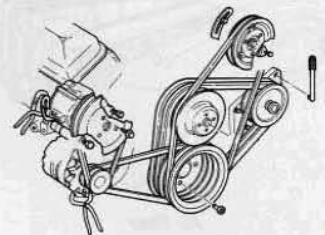

Accessory drivebelts

**Driveshaft** Any shaft used to transmit motion. Commonly used when referring to the axleshafts on a front wheel drive vehicle.

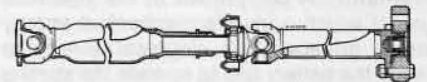

Driveshaft

**Drum brake** A type of brake using a drum-shaped metal cylinder attached to the inner surface of the wheel. When the brake pedal is pressed, curved brake shoes with friction linings press against the inside of the drum to slow or stop the vehicle.

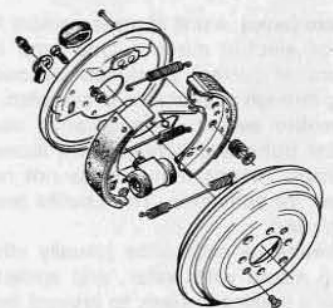

Drum brake assembly



**E**

**EGR valve** A valve used to introduce exhaust gases into the intake air stream.

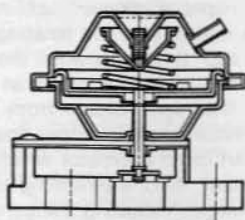

EGR valve

**Electronic control unit (ECU)** A computer which controls (for instance) ignition and fuel injection systems, or an anti-lock braking system. For more information refer to the *Haynes Automotive Electrical and Electronic Systems Manual*.

**Electronic Fuel Injection (EFI)** A computer controlled fuel system that distributes fuel through an injector located in each intake port of the engine.

**Emergency brake** A braking system, independent of the main hydraulic system, that can be used to slow or stop the vehicle if the primary brakes fail, or to hold the vehicle stationary even though the brake pedal isn't depressed. It usually consists of a hand lever that actuates either front or rear brakes mechanically through a series of cables and linkages. Also known as a handbrake or parking brake.

**Endfloat** The amount of lengthwise movement between two parts. As applied to a crankshaft, the distance that the crankshaft can move forward and back in the cylinder block.

**Engine management system (EMS)** A computer controlled system which manages the fuel injection and the ignition systems in an integrated fashion.

**Exhaust manifold** A part with several passages through which exhaust gases leave the engine combustion chambers and enter the exhaust pipe.

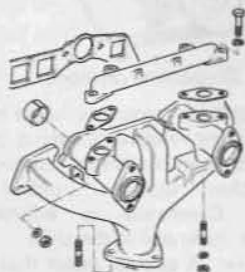

Exhaust manifold

**F**

**Fan clutch** A viscous (fluid) drive coupling device which permits variable engine fan speeds in relation to engine speeds.

**Feeler blade** A thin strip or blade of hardened steel, ground to an exact thickness, used to check or measure clearances between parts.



Feeler blade

**Firing order** The order in which the engine cylinders fire, or deliver their power strokes, beginning with the number one cylinder.

**Flywheel** A heavy spinning wheel in which energy is absorbed and stored by means of momentum. On cars, the flywheel is attached to the crankshaft to smooth out firing impulses.

**Free play** The amount of travel before any action takes place. The "looseness" in a linkage, or an assembly of parts, between the initial application of force and actual movement. For example, the distance the brake pedal moves before the pistons in the master cylinder are actuated.

**Fuse** An electrical device which protects a circuit against accidental overload. The typical fuse contains a soft piece of metal which is calibrated to melt at a predetermined current flow (expressed as amps) and break the circuit.

**Fusible link** A circuit protection device consisting of a conductor surrounded by heat-resistant insulation. The conductor is smaller than the wire it protects, so it acts as the weakest link in the circuit. Unlike a blown fuse, a failed fusible link must frequently be cut from the wire for replacement.

**G**

**Gap** The distance the spark must travel in jumping from the centre electrode to the side

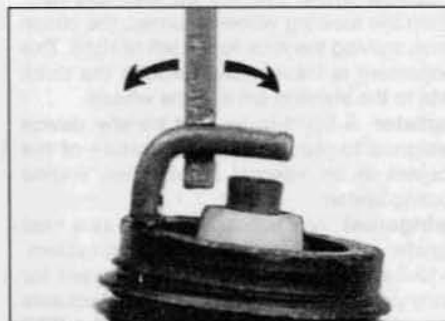

Adjusting spark plug gap

electrode in a spark plug. Also refers to the spacing between the points in a contact breaker assembly in a conventional points-type ignition, or to the distance between the reluctor or rotor and the pickup coil in an electronic ignition.

**Gasket** Any thin, soft material - usually cork, cardboard, asbestos or soft metal - installed between two metal surfaces to ensure a good seal. For instance, the cylinder head gasket seals the joint between the block and the cylinder head.

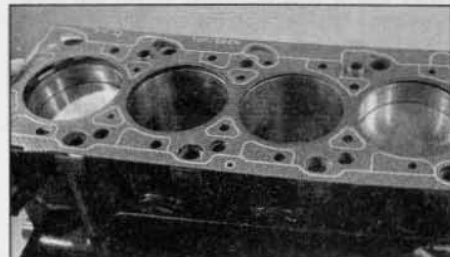

Gasket

**Gauge** An instrument panel display used to monitor engine conditions. A gauge with a movable pointer on a dial or a fixed scale is an analogue gauge. A gauge with a numerical readout is called a digital gauge.

**H**

**Halfshaft** A rotating shaft that transmits power from the final drive unit to a drive wheel, usually when referring to a live rear axle.

**Harmonic balancer** A device designed to reduce torsion or twisting vibration in the crankshaft. May be incorporated in the crankshaft pulley. Also known as a vibration damper.

**Hone** An abrasive tool for correcting small irregularities or differences in diameter in an engine cylinder, brake cylinder, etc.

**Hydraulic tappet** A tappet that utilises hydraulic pressure from the engine's lubrication system to maintain zero clearance (constant contact with both camshaft and valve stem). Automatically adjusts to variation in valve stem length. Hydraulic tappets also reduce valve noise.

**I**

**Ignition timing** The moment at which the spark plug fires, usually expressed in the number of crankshaft degrees before the piston reaches the top of its stroke.

**Inlet manifold** A tube or housing with passages through which flows the air-fuel mixture (carburettor vehicles and vehicles with throttle body injection) or air only (port fuel-injected vehicles) to the port openings in the cylinder head.

**J**

**Jump start** Starting the engine of a vehicle with a discharged or weak battery by attaching jump leads from the weak battery to a charged or helper battery.

**L**

**Load Sensing Proportioning Valve (LSPV)** A brake hydraulic system control valve that works like a proportioning valve, but also takes into consideration the amount of weight carried by the rear axle.

**Locknut** A nut used to lock an adjustment nut, or other threaded component, in place. For example, a locknut is employed to keep the adjusting nut on the rocker arm in position.

**Lockwasher** A form of washer designed to prevent an attaching nut from working loose.

**M**

**MacPherson strut** A type of front suspension system devised by Earle MacPherson at Ford of England. In its original form, a simple lateral link with the anti-roll bar creates the lower control arm. A long strut - an integral coil spring and shock absorber - is mounted between the body and the steering knuckle. Many modern so-called MacPherson strut systems use a conventional lower A-arm and don't rely on the anti-roll bar for location.

**Multimeter** An electrical test instrument with the capability to measure voltage, current and resistance.

**N**

**NOx** Oxides of Nitrogen. A common toxic pollutant emitted by petrol and diesel engines at higher temperatures.

**O**

**Ohm** The unit of electrical resistance. One volt applied to a resistance of one ohm will produce a current of one amp.

**Ohmmeter** An instrument for measuring electrical resistance.

**O-ring** A type of sealing ring made of a special rubber-like material; in use, the O-ring is compressed into a groove to provide the sealing action.



O-ring

**Overhead cam (ohc) engine** An engine with the camshaft(s) located on top of the cylinder head(s).

**Overhead valve (ohv) engine** An engine with the valves located in the cylinder head, but with the camshaft located in the engine block.

**Oxygen sensor** A device installed in the engine exhaust manifold, which senses the oxygen content in the exhaust and converts this information into an electric current. Also called a Lambda sensor.

**P**

**Phillips screw** A type of screw head having a cross instead of a slot for a corresponding type of screwdriver.

**Plastigage** A thin strip of plastic thread, available in different sizes, used for measuring clearances. For example, a strip of Plastigage is laid across a bearing journal. The parts are assembled and dismantled; the width of the crushed strip indicates the clearance between journal and bearing.



Plastigage

**Propeller shaft** The long hollow tube with universal joints at both ends that carries power from the transmission to the differential on front-engined rear wheel drive vehicles.

**Proportioning valve** A hydraulic control valve which limits the amount of pressure to the rear brakes during panic stops to prevent wheel lock-up.

**R**

**Rack-and-pinion steering** A steering system with a pinion gear on the end of the steering shaft that mates with a rack (think of a geared wheel opened up and laid flat). When the steering wheel is turned, the pinion turns, moving the rack to the left or right. This movement is transmitted through the track rods to the steering arms at the wheels.

**Radiator** A liquid-to-air heat transfer device designed to reduce the temperature of the coolant in an internal combustion engine cooling system.

**Refrigerant** Any substance used as a heat transfer agent in an air-conditioning system. R-12 has been the principle refrigerant for many years; recently, however, manufacturers have begun using R-134a, a non-CFC substance that is considered less harmful to the ozone in the upper atmosphere.

**Rocker arm** A lever arm that rocks on a shaft or pivots on a stud. In an overhead valve engine, the rocker arm converts the upward movement of the pushrod into a downward movement to open a valve.

**Rotor** In a distributor, the rotating device inside the cap that connects the centre electrode and the outer terminals as it turns, distributing the high voltage from the coil secondary winding to the proper spark plug. Also, that part of an alternator which rotates inside the stator. Also, the rotating assembly of a turbocharger, including the compressor wheel, shaft and turbine wheel.

**Runout** The amount of wobble (in-and-out movement) of a gear or wheel as it's rotated. The amount a shaft rotates "out-of-true." The out-of-round condition of a rotating part.

**S**

**Sealant** A liquid or paste used to prevent leakage at a joint. Sometimes used in conjunction with a gasket.

**Sealed beam lamp** An older headlight design which integrates the reflector, lens and filaments into a hermetically-sealed one-piece unit. When a filament burns out or the lens cracks, the entire unit is simply replaced.

**Serpentine drivebelt** A single, long, wide accessory drivebelt that's used on some newer vehicles to drive all the accessories, instead of a series of smaller, shorter belts. Serpentine drivebelts are usually tensioned by an automatic tensioner.

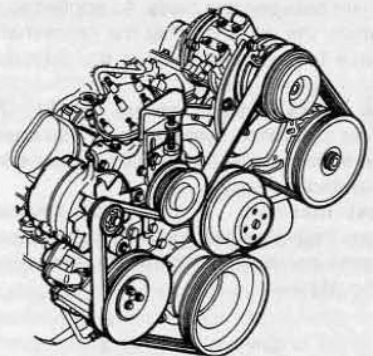

Serpentine drivebelt

**Shim** Thin spacer, commonly used to adjust the clearance or relative positions between two parts. For example, shims inserted into or under bucket tappets control valve clearances. Clearance is adjusted by changing the thickness of the shim.

**Slide hammer** A special puller that screws into or hooks onto a component such as a shaft or bearing; a heavy sliding handle on the shaft bottoms against the end of the shaft to knock the component free.

**Sprocket** A tooth or projection on the periphery of a wheel, shaped to engage with a chain or drivebelt. Commonly used to refer to the sprocket wheel itself.

**Starter inhibitor switch** On vehicles with an automatic transmission, a switch that prevents starting if the vehicle is not in Neutral or Park.

**Strut** See MacPherson strut.

## T

**Tappet** A cylindrical component which transmits motion from the cam to the valve stem, either directly or via a pushrod and rocker arm. Also called a cam follower.

**Thermostat** A heat-controlled valve that regulates the flow of coolant between the cylinder block and the radiator, so maintaining optimum engine operating temperature. A thermostat is also used in some air cleaners in which the temperature is regulated.

**Thrust bearing** The bearing in the clutch assembly that is moved in to the release levers by clutch pedal action to disengage the clutch. Also referred to as a release bearing.

**Timing belt** A toothed belt which drives the camshaft. Serious engine damage may result if it breaks in service.

**Timing chain** A chain which drives the camshaft.

**Toe-in** The amount the front wheels are closer together at the front than at the rear. On rear wheel drive vehicles, a slight amount of toe-in is usually specified to keep the front wheels running parallel on the road by offsetting other forces that tend to spread the wheels apart.

**Toe-out** The amount the front wheels are closer together at the rear than at the front. On front wheel drive vehicles, a slight amount of toe-out is usually specified.

**Tools** For full information on choosing and using tools, refer to the *Haynes Automotive Tools Manual*.

**Tracer** A stripe of a second colour applied to a wire insulator to distinguish that wire from another one with the same colour insulator.

**Tune-up** A process of accurate and careful adjustments and parts replacement to obtain the best possible engine performance.

**Turbocharger** A centrifugal device, driven by exhaust gases, that pressurises the intake air. Normally used to increase the power output from a given engine displacement, but can also be used primarily to reduce exhaust emissions (as on VW's "Umwelt" Diesel engine).

## U

**Universal joint or U-joint** A double-pivoted connection for transmitting power from a driving to a driven shaft through an angle. A U-joint consists of two Y-shaped yokes and a cross-shaped member called the spider.

## V

**Valve** A device through which the flow of liquid, gas, vacuum, or loose material in bulk

may be started, stopped, or regulated by a movable part that opens, shuts, or partially obstructs one or more ports or passageways. A valve is also the movable part of such a device.

**Valve clearance** The clearance between the valve tip (the end of the valve stem) and the rocker arm or tappet. The valve clearance is measured when the valve is closed.

**Vernier caliper** A precision measuring instrument that measures inside and outside dimensions. Not quite as accurate as a micrometer, but more convenient.

**Viscosity** The thickness of a liquid or its resistance to flow.

**Volt** A unit for expressing electrical "pressure" in a circuit. One volt that will produce a current of one ampere through a resistance of one ohm.

## W

**Welding** Various processes used to join metal items by heating the areas to be joined to a molten state and fusing them together. For more information refer to the *Haynes Automotive Welding Manual*.

**Wiring diagram** A drawing portraying the components and wires in a vehicle's electrical system, using standardised symbols. For more information refer to the *Haynes Automotive Electrical and Electronic Systems Manual*.



**A**

Accelerator cable - 4A•3, 4B•9, 4C•8  
 Accelerator lever switch - 4D•4  
 Accelerator pedal - 4A•3, 4B•10, 4C•9  
 Accelerator pedal position sensor - 4A•10, 4C•15  
 Accessory shops - REF•3  
 Accessory socket - 12•13  
 Acknowledgements - 0•6  
 Air conditioning system - 3•10  
   refrigerant leak - 1A•8  
 Air distribution housing - 4B•3  
 Air filter - 1A•14, 1B•19, 4A•2, 4B•3, 4C•5  
 Air injection valve - 4D•3  
 Air pump - 4D•3  
 Air temperature sensor - 4A•9  
 Airbags - 0•5, 1A•16, 1B•23, 12•16, 12•17  
 Airflow meter - 4C•13, 4C•14  
 Alarm system - 12•16  
 Alternator - 5A•4, 5A•5  
 Antifreeze - 0•14, 0•19, 1A•16, 1B•23  
 Anti-lock braking system (ABS) - 9•12  
 Anti-roll bar - 10•8, 10•9  
 Anti-theft alarm system - 12•16  
 Asbestos - 0•5  
 Audio unit - 12•15  
 Auxiliary drivebelt - 1A•9, 1B•11, 1B•15  
 Axle - 10•11

**B**

Badges - 11•18  
 Battery - 0•5, 0•17, 5A•2, 5A•3, REF•5

Big-end bearings - 2D•10, 2E•13

**Bleeding**

brakes - 9•2  
 fuel system - 4B•2  
 fuel system - 4C•9  
 power steering - 10•14

Blower motor - 3•9

Body accelerometer - 4A•10

Body corrosion - REF•11

Body electrical systems - 12•1 et seq

Bodywork and fittings - 11•1 et seq

Bonnet - 11•5, 11•6

Brake fluid - 0•16, 0•19, 1A•13, 1B•21  
 leak - 1A•8

Braking system - 1A•9, 1B•11, 9•1 et seq, REF•8, REF•9, REF•10  
 fault finding - REF•16

Built-in systems interface (BSI) unit - 12•18

Bulbs - 12•5, 12•9

Bumpers - 11•4, 11•5

Burning - 0•5

Buying spare parts - REF•3

**C****Cables**

accelerator - 4A•3, 4B•9, 4C•8  
 bonnet release - 11•6  
 clutch - 6•1  
 handbrake - 9•11  
 heater/ventilation control - 3•8  
 sliding side door holding latch - 11•11

Calipers - 9•9

Camshaft - 2A•12, 2A•13, 2B•9, 2C•16

Camshaft oil seal - 2B•14, 2C•15, 2A•11

*Note: References throughout this index are in the form "Chapter number" • "Page number". So, for example, 2C•15 refers to page 15 of Chapter 2C.*

Camshaft position sensor – 4A•10, 4C•14  
 Camshaft sprocket – 2A•10, 2A•11, 2B•6, 2C•13, 2C•15  
 Carpets – 11•2  
 Catalytic converter – 4A•12, 4D•5  
 Central locking – 11•16  
 Centre console – 11•21  
 Centre pillar trim panel – 11•20  
 Charcoal canister renewal – 4D•2  
 Charging – 5A•2, 5A•4  
 Child lock – 11•11  
 Cigarette lighter – 12•13  
 Clutch – 6•1 *et seq*  
     fault finding – REF•15  
 Coil unit – 5B•2  
 Compression test – 2A•3, 2B•3, 2C•4  
 Connecting rods – 2D•7, 2D•9, 2D•13, 2E•8, 2E•11, 2E•15  
 Console – 11•21  
 Control unit (central locking) – 11•16  
 Conversion factors – REF•2  
 Coolant – 0•14, 0•19, 1A•15, 1B•22  
     leak – 1A•7  
 Coolant pump – 3•7  
     sprocket – 2B•7, 2C•15  
 Coolant temperature sensor – 4A•9, 4C•13, 4C•14  
 Cooling fan(s) – 3•5  
     switch – 3•6  
 Cooling, heating and air conditioning systems – 3•1 *et seq*  
     fault finding – REF•14  
 Courtesy lights – 12•9  
     switch – 12•5  
 Crankcase – 2D•7, 2E•10  
 Crankcase emission control – 4D•1, 4D•2, 4D•3  
 Crankshaft – 2D•7, 2D•9, 2D•11, 2E•9, 2E•12, 2E•14  
 Crankshaft oil seals – 2A•18, 2B•14, 2C•21  
 Crankshaft pulley – 2B•4, 2C•6  
 Crankshaft sensor – 4A•9, 4C•13, 4C•14  
 Crankshaft sprocket – 2A•10, 2A•11, 2B•7, 2C•14, 2C•15  
 Crushing – 0•5  
 Curtain airbag – 12•18  
 Cylinder block – 2D•7, 2E•10  
 Cylinder head – 2A•14, 2B•10, 2C•18, 2D•4, 2D•5, 2D•6, 2E•4,  
     2E•6, 2E•7, 2E•8  
 Cylinder head cover – 2A•5, 2B•4, 2C•6

## D

Dents – 11•2  
 Depressurisation and pressurising fuel system – 4A•4  
 Diesel engine in-car repair procedures  
     1.8 and 1.9 litre (XUD series) – 2B•1 *et seq*  
     1.9 and 2.0 litre (DW series) – 2C•1 *et seq*  
 Diesel engine removal and overhaul procedures – 2E•1 *et seq*  
 Diesel injection equipment – 0•5  
 Dimensions – REF•1  
 Direction indicators – 12•6, 12•7  
 Disconnecting the battery – REF•5  
 Discs – 9•7  
 Doors – 11•6 to 11•9, 11•11, 11•13, 11•16, 11•17, 11•20, REF•9  
 Drivebelt – 1A•9, 1B•11, 1B•15  
 Driveshafts – 8•1 *et seq*, REF•10  
     fault finding – REF•16  
     gaiter – 1A•8, 1B•10  
     oil seals – 7•5  
 Drivetrain – 1A•9, 1B•10  
 Drums – 9•8

## E

Earth fault – 12•2  
 EGR system – 4D•3, 4D•4  
     temperature switch/sensor – 3•6  
 Electric cooling fan(s) – 3•5  
 Electric shock – 0•5  
 Electrical equipment – 1A•9, 1B•10, REF•9  
 Electrical systems – 0•17  
     fault finding – 12•2, REF•18  
 Electronic Control Unit (ECU)  
     ABS – 9•13  
     diesel injection system – 4C•12, 4C•14  
     fuel system – 4A•8  
 Emission control systems – 1A•15, 1B•21, 4D•1 *et seq*, REF•11  
 Engine assembly/valve timing holes – 2A•4, 2B•3, 2C•5  
 Engine fault finding – REF•13, REF•14  
 Engine immobiliser – 12•16  
 Engine management system – 4A•3, 4A•5, 4A•6  
     coolant temperature sensor – 3•6  
 Engine oil – 0•13, 0•19, 1A•9, 1B•8  
     leak – 1A•8  
 Environmental considerations – REF•4  
 Evaporative emission control – 4D•2  
 Exhaust emission control – 4D•1, 4D•2, 4D•3  
 Exhaust gas recirculation system – 4D•2  
 Exhaust manifold – 4A•11, 4B•10, 4C•21  
 Exhaust specialists – REF•3  
 Exhaust system – 1A•12, 1B•16, 4A•11, 4B•10, 4C•23, REF•10,  
     REF•11

## F

Facia – 11•22, 11•23, 11•24  
     switches – 12•4, 12•5  
 Fan(s) – 3•5  
     switch – 3•6  
 Fast idle thermostatic sensor – 4B•3, 4C•10  
 Fault finding – REF•12 *et seq*  
     braking system – REF•16  
     clutch – REF•15  
     cooling system – REF•14  
     finding driveshafts – REF•16  
     electrical system – 12•2, REF•18  
     engine – REF•13, REF•14  
     fuel and exhaust systems – REF•15  
     suspension and steering systems – REF•17  
     transmission – REF•15  
 Filling and respraying – 11•3  
 Filter  
     air – 1A•14, 1B•19, 4A•2, 4B•3, 4C•5  
     fuel – 1A•14, 1B•8, 1B•17, 3•7  
     oil – 1A•9, 1B•8  
     pollen – 1A•9, 1B•11  
 Fire – 0•5  
 Fluid leak – 1A•7, 1B•10  
 Fluids – 0•19  
 Flywheel – 2A•18, 2B•14  
 Foglight – 12•7, 12•10  
 Followers – 2A•13, 2B•9, 2C•16  
 Fuel and exhaust systems – 1.8 and 1.9 litre (XUD series) diesel  
     models – 4B•1 *et seq*  
 Fuel and exhaust systems – 1.9 and 2.0 litre (DW series) diesel  
     models – 4C•1 *et seq*  
 Fuel and exhaust systems – petrol models – 4A•1 *et seq*  
     fault finding – REF•15

Fuel cut-off inertia switch – 4A•10, 4C•12, 4C•14  
 Fuel filter – 1A•14, 1B•8, 1B•17  
   housing – 3•7  
 Fuel gauge sender unit – 4A•5, 4B•10, 4C•10  
 Fuel heater – 4C•15  
 Fuel injection pump – 4B•4, 4B•7, 4C•11, 4C•16  
   sprocket – 2B•7  
 Fuel injectors – 4B•8, 4C•17  
 Fuel leak – 1A•8  
 Fuel pressure regulator – 4A•7  
 Fuel pressure sensor – 4C•15  
 Fuel pump – 4A•4  
 Fuel rail – 4A•6, 4C•19  
 Fuel regulator – 4C•15  
 Fuel supply pump – 4C•10  
 Fuel system – REF•11  
 Fuel tank – 4A•5  
 Fuel temperature sensor – 4C•14  
 Fume or gas intoxication – 0•5  
 Fuses – 12•3, 12•18

## G

Gaiters  
   driveshaft – 1A•8, 1B•10, 8•3, 8•6  
 Gashes – 11•2  
 Gaskets – REF•4  
 Gearchange linkage – 7•3  
 General repair procedures – REF•4  
 Glossary of technical terms – REF•21 *et seq*  
 Glow plugs – 5C•2  
 Grille – 11•18

## H

Handbrake – 9•11, REF•8  
   warning light switch – 9•12  
 Handles  
   door – 11•8  
   hinged rear door – 11•11  
   sliding side door – 11•9  
 Headlight – 12•5, 12•9  
   beam alignment – 12•11  
 Headlining – 11•21  
 Heat shields – 4A•12, 4B•11, 4C•23  
 Heater – 3•8, 3•9  
   control – 12•5, 12•9  
 High-level stop-light – 12•7, 12•10  
 High-pressure fuel regulator – 4C•15  
 Hinge lubrication – 1A•9, 1B•10  
 Hinged rear door – 11•7, 11•8, 11•11  
   latches – 11•13  
   locks – 11•16  
 Horn – 12•13  
 Hose and fluid leak – 1A•7, 1B•10  
 Hoses – 3•2, 9•3  
 HT coil unit – 5B•2  
 Hub bearings – 10•2, 10•4, 10•10  
 Hydrofluoric acid – 0•5

## I

Identifying leaks – 0•10  
 Idle speed stepper motor – 4A•8  
 Idler pulley – 2A•10, 2A•11, 2C•15

Idler roller – 2B•8  
 Ignition switch – 10•13  
 Ignition system – petrol models – 5B•1 *et seq*  
 Immobiliser – 12•16  
 Indicators – 12•7  
 Inertia switch – 4A•10  
 Injection pump – 4B•4, 4B•7, 4C•11, 4C•16  
   sprocket – 2C•13, 2C•15  
 Injection timing – 4B•6, 4B•7, 4C•17  
 Injector needle lift sensor – 4C•13  
 Injectors – 4A•6, 4B•8, 4C•17  
 Inlet air temperature sensor – 4A•9  
 Inlet manifold – 4A•10, 4B•10, 4C•20  
 Input shaft oil seal – 7•5  
 Instruments – 1A•9, 1B•10, 12•11  
   illumination – 12•9  
 Intake ducts – 4A•2, 4C•5  
 Introduction to the Citroën Berlingo & Peugeot Partner – 0•

## J

Jacking and vehicle support – REF•3  
 Joint mating faces – REF•4  
 Jump starting – 0•8

## K

Knock sensor – 5B•3

## L

Lambda sensors – 4D•3  
 Latches (hinged rear door) – 11•13  
 Leakdown test – 2B•3, 2C•4  
 Leaks – 0•10, 1A•7, 1B•10  
 Light units – 12•9  
 Locknuts, locktabs and washers – REF•4  
 Locks  
   bonnet – 11•6  
   central locking – 11•16  
   door – 11•8, 11•16  
   hinged rear door – 11•11, 11•16  
   lubrication – 1A•9, 1B•10  
   sliding side door – 11•9, 11•16  
   steering column – 10•13  
   tailgate – 11•15, 11•16  
 Loudspeakers – 12•15  
 Lower arm – 10•7  
 Lubricants and fluids – 0•19  
 Luggage compartment side trim panel – 11•21

## M

Main bearings – 2D•10, 2E•13  
 Manifold pressure sensor – 4A•9  
 Manifolds – 4A•10, 4A•11, 4B•10, 4C•20, 4C•21  
 Manual transmission – 2B•15, 2C•21, 2D•3, 2E•3, 7•1 *et seq*  
   fault finding – REF•15  
   mountings – 2A•18  
   oil – 0•19, 1A•15, 1B•20  
   oil seals – 7•5  
 Master cylinder – 9•9  
 Matrix – 3•9  
 Mirrors – 11•16, REF•8



Modulator assembly (ABS) – 9•12  
 MOT test checks – REF•8 et seq  
 Motor factors – REF•3  
 Mountings – 2A•18, 2B•7, 2B•15, 2C•21  
 Multi-function display unit – 12•12  
 illumination – 12•9

## N

Number plate light – 12•8, 12•11

## O

Oil  
 engine – 0•13, 0•19, 1A•9, 1B•8  
 leak – 1A•8  
 manual transmission – 0•19, 1A•15, 1B•20  
 Oil cooler – 2B•15  
 Oil filter – 1A•9, 1B•8  
 Oil level sensor – 5A•6  
 Oil pressure warning light switch – 5A•6  
 Oil pump – 2A•17, 2B•13, 2C•21  
 Oil seals – REF•4  
 camshaft – 2A•11, 2B•14, 2C•15  
 crankshaft – 2A•18, 2B•14, 2C•21  
 transmission – 7•5  
 Open-circuit – 12•2

## P

Pads – 1A•11, 1B•16, 9•3, REF•3  
 Pedals  
 accelerator – 4A•3, 4A•10, 4B•10, 4C•9, 4C•15  
 clutch – 6•2  
 Petrol engine in-car repair procedures – 2A•1 et seq  
 Petrol engine removal and overhaul procedures – 2D•1 et seq  
 Pillar trim panel – 11•20  
 Pipes – 9•3  
 Piston rings – 2D•11, 2E•13  
 Pistons – 2D•7, 2D•9, 2D•13, 2E•8, 2E•11, 2E•15  
 Plastic components – 11•3  
 Poisonous or irritant substances – 0•5  
 Pollen filter – 1A•9, 1B•11  
 Power steering fluid – 0•15, 0•19  
 Pre/post-heating system – diesel models – 5C•1 et seq  
 Preheating temperature switch/sensor – 3•6  
 Pressure sensor – 4C•15  
 Pressure-regulating valve (braking system) – 9•11  
 Pressurising fuel system – 4A•4  
 Priming and bleeding fuel system – 4B•2, 4C•9  
 Puncture repair – 0•9  
 Purge valve(s) – 4D•2

## R

Radiator – 1A•16, 1B•22, 3•3  
 grille – 11•18  
 Rear axle – 10•11  
 Rear light cluster – 12•7  
 Refrigerant leak – 1A•8  
 Regulator (window glass) – 11•13  
 Relays – 12•3  
 Release mechanism (clutch) – 6•4  
 Remote control transmitter (central locking) – 11•16

Repair procedures – REF•4  
 Respraying – 11•3  
 Reversing light switch – 7•5  
 Ride height – 10•11  
 Road test – 1A•9, 1B•10  
 Roadside repairs – 0•7 et seq  
 Rocker arms – 2A•12, 2A•13  
 Routine maintenance – bodywork and underframe – 11•1  
 Routine maintenance – upholstery and carpets – 11•2  
 Routine maintenance and servicing – diesel models – 1B•1 et seq  
 Routine maintenance and servicing – petrol models – 1A•1 et seq  
 Rust holes or gashes – 11•2

## S

Safety first! – 0•5, 0•15, 0•16  
 Scalding – 0•5  
 Scratches – 11•2  
 Screw threads and fastenings – REF•4  
 Scuttle grille panel – 11•18  
 Seat belt pretensioners – 1A•16, 1B•23  
 Seat belts – 11•19  
 Seats – 11•19  
 Secondary air injection – 4D•2, 4D•3  
 Selector shaft oil seal – 7•5  
 Service indicator – 1A•9, 1B•11  
 Servo unit – 9•10  
 Shock absorbers – 1A•12, 1B•16, 10•10, REF•9, REF•10  
 Shoes – 1A•12, 1B•16, 9•5  
 Short-circuit – 12•2  
 Side airbag – 12•18  
 Side door – 11•6, 11•8, 11•9  
 locks – 11•16  
 sill trim panel – 11•20  
 window glass – 11•17  
 Side trim panel – 11•20, 11•21  
 Sidelight – 12•6  
 Sill trim panel – 11•20  
 Sliding side door – 11•6, 11•8, 11•9  
 locks – 11•16  
 sill trim panel – 11•20  
 Spare parts – REF•3  
 Spark plug – 1A•13  
 Speed sensor – 4A•10, 9•13  
 Speedometer drive – 7•6  
 Springs – REF•10  
 Starting and charging systems – 5A•1 et seq  
 Start-up after overhaul – 2D•13, 2E•16  
 Steering – 1A•9, 1A•12, 1B•10, 1B•16, REF•9, REF•10  
 Steering angles – 10•15  
 Steering column – 10•12, REF•8  
 lock – 10•13  
 shrouds – 11•22, 11•23  
 switches – 12•3  
 Steering gear – 10•13  
 Steering pump – 10•14  
 Steering wheel – 10•11, REF•8  
 Stop solenoid – 4C•12  
 Stop-light – 12•7, 12•10  
 switch – 9•12  
 Strut  
 suspension – 1A•12, 1B•16, 10•4, 10•5  
 tailgate – 11•14  
 Subframe – 10•9  
 Sump – 2A•17, 2B•13, 2C•20  
 Sunroof – 11•17  
 Support struts (tailgate) – 11•14

**Suspension** – 1A•9, 1A•12, 1B•16, 1B•10, REF•9, REF•10

**Suspension and steering** – 10•1 *et seq*

fault finding – REF•17

**Switches** – 12•3

cooling fan – 3•6

fuel cut-off – 4A•10, 4C•12, 4C•14

handbrake 'on' warning light – 9•12

ignition – 10•13

illumination – 12•9

oil pressure warning light – 5A•6

reversing light – 7•5

stop-light – 9•12

temperature warning light – 3•6

**Swivel hub** – 10•2

## T

**Tailgate** – 11•14, 11•17

lock – 11•15, 11•16

trim panel – 11•21

**Tailpipe** – 4A•12, 4B•11, 4C•23

**Temperature sensor** – 3•6, 4A•9, 4C•13, 4C•14

**Temperature switch/sensor** – 3•6

**Temperature warning light switch** – 3•6

**Tensioner** – 2A•10, 2A•11, 2B•8, 2C•15

**Thermostat** – 3•4

housing – 3•7

**Third piston deactivator solenoid valve** – 4C•15

**Throttle housing** – 4A•6

heating element – 4A•9

**Throttle potentiometer** – 4A•8, 4C•14

**Throttle valve positioner motor** – 4A•10

**Timing**

ignition – 5B•3

injection – 4B•6, 4B•7, 4C•17

**Timing belt** – 2A•7, 2B•5, 2C•9, 2C•11

**Timing belt covers** – 2A•6, 2B•5, 2C•7

**Timing belt sprockets** – 2A•10, 2B•6, 2C•13

**Tools and working facilities** – REF•4, REF•6 *et seq*

**Towing** – 0•10

**Track rod balljoint** – 10•15

**Trim panels** – 11•7, 11•18, 11•20

**Turbocharger** – 4C•22, 4C•23

**Tyres** – REF•11

condition and pressure – 0•18

pressures – 0•20

specialists – REF•3

## U

**Underbonnet check points** – 0•11

**Underframe** – 11•1

**Unleaded petrol** – 4A•3

**Upholstery** – 11•2

## V

**Vacuum hoses leak** – 1A•8

**Vacuum pump** – 9•13, 9•14

**Vacuum servo unit** – 9•10

**Valve clearances** – 2A•12, 2B•9, 2C•17

**Valve timing holes** – 2A•4, 2B•3, 2C•5

**Valves** – 2D•5, 2D•6, 2E•7, 2E•8

**Vehicle identification numbers** – REF•3, REF•9

**Vehicle ride height** – 10•11

**Vehicle speed sensor** – 4A•10

**Vehicle support** – REF•3

**Ventilation system** – 3•8

control – 12•5, 12•9

## W

**Warning light bulbs** – 12•9

**Washer fluid** – 0•14

**Washer system** – 12•14

**Weekly checks** – 0•11 *et seq*

**Weights** – REF•1

**Wheel alignment** – 10•15

**Wheel arch liners** – 11•18

**Wheel bearings** – 10•2, 10•4, 10•10, REF•10

**Wheel changing** – 0•9

**Wheel cylinder** – 9•9

**Wheel speed sensor** – 9•13

**Wheels** – REF•11

**Window glass and regulator** – 11•13

**Windscreen** – 11•17, REF•8

**Wiper arm** – 12•13

**Wiper blades** – 0•16

**Wiper linkage** – 12•13

**Wiper motor** – 12•13, 12•14

**Wiring diagrams** – 12•19 *et seq*

**Working facilities** – REF•7

101	...	...	...
102	...	...	...
103	...	...	...
104	...	...	...
105	...	...	...
106	...	...	...
107	...	...	...
108	...	...	...
109	...	...	...
110	...	...	...
111	...	...	...
112	...	...	...
113	...	...	...
114	...	...	...
115	...	...	...
116	...	...	...
117	...	...	...
118	...	...	...
119	...	...	...
120	...	...	...
121	...	...	...
122	...	...	...
123	...	...	...
124	...	...	...
125	...	...	...
126	...	...	...
127	...	...	...
128	...	...	...
129	...	...	...
130	...	...	...
131	...	...	...
132	...	...	...
133	...	...	...
134	...	...	...
135	...	...	...
136	...	...	...
137	...	...	...
138	...	...	...
139	...	...	...
140	...	...	...
141	...	...	...
142	...	...	...
143	...	...	...
144	...	...	...
145	...	...	...
146	...	...	...
147	...	...	...
148	...	...	...
149	...	...	...
150	...	...	...
151	...	...	...
152	...	...	...
153	...	...	...
154	...	...	...
155	...	...	...
156	...	...	...
157	...	...	...
158	...	...	...
159	...	...	...
160	...	...	...
161	...	...	...
162	...	...	...
163	...	...	...
164	...	...	...
165	...	...	...
166	...	...	...
167	...	...	...
168	...	...	...
169	...	...	...
170	...	...	...
171	...	...	...
172	...	...	...
173	...	...	...
174	...	...	...
175	...	...	...
176	...	...	...
177	...	...	...
178	...	...	...
179	...	...	...
180	...	...	...
181	...	...	...
182	...	...	...
183	...	...	...
184	...	...	...
185	...	...	...
186	...	...	...
187	...	...	...
188	...	...	...
189	...	...	...
190	...	...	...
191	...	...	...
192	...	...	...
193	...	...	...
194	...	...	...
195	...	...	...
196	...	...	...
197	...	...	...
198	...	...	...
199	...	...	...
200	...	...	...



# Haynes Manuals - The Complete List

Title	Book No.	Title	Book No.	Title	Book No.
<b>ALFA ROMEO</b> Alfasud/Sprint (74 - 88) up to F *	<b>0292</b>	Fiat Regata Petrol (84 - 88) A to F	<b>1167</b>	Lada Samara (87 - 91) D to J	<b>1610</b>
Alfa Romeo Alfetta (73 - 87) up to E *	<b>0531</b>	Fiat Tipo Petrol (88 - 91) E to J	<b>1625</b>	<b>LAND ROVER</b> 90, 110 & Defender Diesel (83 - 95) up to N	<b>3017</b>
<b>AUDI</b> 80, 90 & Coupe Petrol (79 - Nov 88) up to F	<b>0605</b>	Fiat Uno Petrol (83 - 95) up to M	<b>0923</b>	Land Rover Discovery Petrol & Diesel (89 - 98) G to S	<b>3016</b>
Audi 80, 90 & Coupe Petrol (Oct 86 - 90) D to H	<b>1491</b>	Fiat X1/9 (74 - 89) up to G *	<b>0273</b>	Land Rover Freelander Petrol & Diesel (97 - 02) R-reg. onwards	<b>3929</b>
Audi 100 & 200 Petrol (Oct 82 - 90) up to H	<b>0907</b>	<b>FORD</b> Anglia (59 - 68) up to G *	<b>0001</b>	Land Rover Series IIA & III Diesel (58 - 85) up to C	<b>0529</b>
Audi 100 & A6 Petrol & Diesel (May 91 - May 97) H to P	<b>3504</b>	Ford Capri II (& III) 1.6 & 2.0 (74 - 87) up to E *	<b>0283</b>	Land Rover Series II, IIA & III 4-cyl Petrol (58 - 85) up to C	<b>0314</b>
Audi A3 (96 - May 03) P to O3	<b>4253</b>	Ford Cortina Mk III 1300 & 1600 (70 - 76) up to P *	<b>0070</b>	<b>MAZDA</b> 323 (Mar 81 - Oct 89) up to G	<b>1608</b>
Audi A4 Petrol & Diesel (95 - Feb 00) M to V	<b>3575</b>	Ford Escort Mk I 1100 & 1300 (68 - 74) up to N *	<b>0171</b>	Mazda 323 (Oct 89 - 98) G to R	<b>3455</b>
<b>AUSTIN</b> A35 & A40 (56 - 67) up to F *	<b>0118</b>	Ford Escort Mk I Mexico, RS 1600 & RS 2000 (70 - 74) up to N *	<b>0139</b>	Mazda 626 (May 83 - Sept 87) up to E	<b>0929</b>
Austin/MG/Rover Maestro 1.3 & 1.6 Petrol (83 - 95) up to M	<b>0922</b>	Ford Escort Mk II Mexico, RS 1800 & RS 2000 (75 - 80) up to W *	<b>0735</b>	Mazda B1600, B1800 & B2000 Pick-up Petrol (72 - 88) up to F	<b>0267</b>
Austin/MG Metro (80 - May 90) up to G	<b>0718</b>	Ford Escort (75 - Aug 80) up to V *	<b>0280</b>	Mazda RX-7 (79 - 85) up to C *	<b>0460</b>
Austin/Rover Montego 1.3 & 1.6 Petrol (84 - 94) A to L	<b>1066</b>	Ford Escort Petrol (Sept 80 - Sept 90) up to H	<b>0686</b>	<b>MERCEDES-BENZ</b> 190, 190E & 190D Petrol & Diesel (83 - 93) A to L	<b>3450</b>
Austin/MG/Rover Montego 2.0 Petrol (84 - 95) A to M	<b>1067</b>	Ford Escort & Orion Petrol (Sept 90 - 00) H to X	<b>1737</b>	Mercedes-Benz 200D, 240D, 240TD, 300D & 300TD 123 Series Diesel (Oct 76 - 85) up to C	<b>1114</b>
Mini (59 - 69) up to H *	<b>0527</b>	Ford Escort & Orion Diesel (Sept 90 - 00) H to X	<b>4081</b>	Mercedes-Benz 250 & 280 (68 - 72) up to L *	<b>0346</b>
Mini (69 - 01) up to X	<b>0646</b>	Ford Fiesta (76 - Aug 83) up to Y	<b>0334</b>	Mercedes-Benz 250 & 280 123 Series Petrol (Oct 76 - 84) up to B *	<b>0677</b>
Austin/Rover 2.0 litre Diesel Engine (86-93) C to L	<b>1857</b>	Ford Fiesta Petrol (Aug 83 - Feb 89) A to F	<b>1030</b>	Mercedes-Benz 124 Series Petrol & Diesel (85 - Aug 93) C to K	<b>3253</b>
<b>AUSTIN HEALEY</b> 100/6 & 3000 (56 - 68) up to G *	<b>0049</b>	Ford Fiesta Petrol (Feb 89 - Oct 95) F to N	<b>1595</b>	Mercedes-Benz C-Class Petrol & Diesel (93 - Aug 00) L to W	<b>3511</b>
<b>BEDFORD</b> CF Petrol (69 - 87) up to E	<b>0163</b>	Ford Fiesta Petrol & Diesel (Oct 95 - Mar 02) N to O2	<b>3397</b>	<b>MGA</b> (55 - 62) *	<b>0475</b>
Bedford/Vauxhall Rascal & Suzuki Supercarry (86 - Oct 94) C to M	<b>3015</b>	Ford Fiesta Petrol & Diesel (Apr 02 - 05) O2 to 54	<b>4170</b>	MGB (62 - 80) up to W	<b>0111</b>
<b>BMW</b> 316, 320 & 320i (4-cyl) (75 - Feb 83) up to Y *	<b>0276</b>	Ford Focus Petrol & Diesel (98 - 01) S to Y	<b>3759</b>	MG Midget & Austin-Healey Sprite (58 - 80) up to W *	<b>0265</b>
BMW 320, 320i, 323i & 325i (6-cyl) (Oct 77 - Sept 87) up to E	<b>0815</b>	Ford Focus Petrol & Diesel (Oct 01 - 04) 51 to 54 reg.	<b>4167</b>	<b>MITSUBISHI</b> Shogun & L200 Pick-Ups Petrol (83 - 94) up to M	<b>1944</b>
BMW 3- & 5-Series Petrol (81 - 91) up to J	<b>1948</b>	Ford Galaxy Petrol & Diesel (95 - Aug 00) M to W	<b>3984</b>	<b>MORRIS</b> Ital 1.3 (80 - 84) up to B	<b>0705</b>
BMW 3-Series Petrol (Apr 91 - 96) H to N	<b>3210</b>	Ford Granada Petrol (Sept 77 - Feb 85) up to B *	<b>0481</b>	Morris Minor 1000 (56 - 71) up to K	<b>0024</b>
BMW 3-Series Petrol (Sept 98 - 03) S-reg. on	<b>4067</b>	Ford Granada & Scorpio Petrol (Mar 85 - 94) B to M	<b>1245</b>	<b>NISSAN</b> Almera Petrol (95 - Feb 00) N to V	<b>4053</b>
BMW 520i & 525e (Oct 81 - June 88) up to E	<b>1560</b>	Ford Ka (96 - 02) P-reg. onwards	<b>3570</b>	Nissan Bluebird (May 84 - Mar 86) A to C	<b>1223</b>
BMW 525, 528 & 528i (73 - Sept 81) up to X *	<b>0632</b>	Ford Mondeo Petrol (93 - Sept 00) K to X	<b>1923</b>	Nissan Bluebird Petrol (Mar 86 - 90) C to H	<b>1473</b>
BMW 5-Series Petrol (April 96 - Aug 03) N to O3	<b>4151</b>	Ford Mondeo Petrol & Diesel (Oct 00 - Jul 03) X to O3	<b>3990</b>	Nissan Cherry (Sept 82 - 86) up to D	<b>1031</b>
BMW 1500, 1502, 1600, 1602, 2000 & 2002 (59 - 77) up to S *	<b>0240</b>	Ford Mondeo Diesel (93 - 96) L to N	<b>3465</b>	Nissan Micra (83 - Jan 93) up to K	<b>0931</b>
<b>CHRYSLER</b> PT Cruiser Petrol (00 - 03) W-reg. onwards	<b>4058</b>	Ford Orion Petrol (83 - Sept 90) up to H	<b>1009</b>	Nissan Micra (93 - 99) K to T	<b>3254</b>
<b>CITROËN</b> 2CV, Ami & Dyane (67 - 90) up to H	<b>0196</b>	Ford Orion Petrol & Diesel (82 - 93) up to K	<b>0903</b>	Nissan Primera Petrol (90 - Aug 99) H to T	<b>1851</b>
Citroën AX Petrol & Diesel (87 - 97) D to P	<b>3014</b>	Ford Sierra 4-cyl Petrol (82 - 91) up to J	<b>0904</b>	Nissan Stanza (82 - 86) up to D	<b>0824</b>
Citroën BX Petrol (83 - 94) A to L	<b>0908</b>	Ford Transit Petrol (Mk 2) (78 - Jan 86) up to C	<b>0719</b>	Nissan Sunny Petrol (May 82 - Oct 86) up to D	<b>0895</b>
Citroën C15 Van Petrol & Diesel (89 - Oct 98) F to S	<b>3509</b>	Ford Transit Petrol (Mk 3) (Feb 86 - 89) C to G	<b>1468</b>	Nissan Sunny Petrol (Oct 86 - Mar 91) D to H	<b>1378</b>
Citroën C3 (02 - 05) 51 to 05	<b>4197</b>	Ford Transit Diesel (Feb 86 - 99) C to T	<b>3019</b>	Nissan Sunny Petrol (Apr 91 - 95) H to N	<b>3219</b>
Citroën CX Petrol (75 - 88) up to F	<b>0528</b>	Ford 1.6 & 1.8 litre Diesel Engine (84 - 96) A to N	<b>1172</b>	<b>OPEL</b> Ascona & Manta (B Series) (Sept 75 - 88) up to F *	<b>0316</b>
Citroën Saxo Petrol & Diesel (96 - 01) N to X	<b>3506</b>	Ford 2.1, 2.3 & 2.5 litre Diesel Engine (77 - 90) up to H	<b>1606</b>	Opel Ascona Petrol (81 - 88)	<b>3215</b>
Citroën Visa Petrol (79 - 88) up to F	<b>0620</b>	<b>FREIGHT ROVER</b> Sherpa Petrol (74 - 87) up to E	<b>0463</b>	Opel Astra Petrol (Oct 91 - Feb 98)	<b>3156</b>
Citroën Xantia Petrol & Diesel (93 - 01) K to Y	<b>3082</b>	<b>HILLMAN</b> Avenger (70 - 82) up to Y	<b>0037</b>	Opel Corsa Petrol (83 - Mar 93)	<b>3160</b>
Citroën XM Petrol & Diesel (89 - 00) G to X	<b>3451</b>	Hillman Imp (63 - 76) up to R *	<b>0022</b>	Opel Corsa Petrol (Mar 93 - 97)	<b>3159</b>
Citroën Xsara Petrol & Diesel (97 - Sept 00) R to W	<b>3751</b>	<b>HONDA</b> Civic (Feb 84 - Oct 87) A to E	<b>1226</b>	Opel Kadett Petrol (Nov 79 - Oct 84) up to B	<b>0634</b>
Citroën Xsara Picasso Petrol & Diesel (00 - 02) W-reg. onwards	<b>3944</b>	Honda Civic (Nov 91 - 96) J to N	<b>3199</b>	Opel Kadett Petrol (Oct 84 - Oct 91)	<b>3196</b>
Citroën ZX Diesel (91 - 98) J to S	<b>1922</b>	Honda Civic Petrol (Mar 95 - 00) M to X	<b>4050</b>	Opel Omega & Senator Petrol (Nov 86 - 94)	<b>3157</b>
Citroën ZX Petrol (91 - 98) H to S	<b>1881</b>	<b>HYUNDAI</b> Pony (85 - 94) C to M	<b>3398</b>	Opel Rekord Petrol (Feb 78 - Oct 86) up to D	<b>0543</b>
Citroën 1.7 & 1.9 litre Diesel Engine (84 - 96) A to N	<b>1379</b>	<b>JAGUAR</b> E Type (61 - 72) up to L *	<b>0140</b>	Opel Vectra Petrol (Oct 88 - Oct 95)	<b>3158</b>
<b>FIAT</b> 126 (73 - 87) up to E *	<b>0305</b>	Jaguar MkI & II, 240 & 340 (55 - 69) up to H *	<b>0098</b>	<b>PEUGEOT</b> 106 Petrol & Diesel (91 - 02) J-reg. onwards	<b>1882</b>
Fiat 500 (57 - 73) up to M *	<b>0090</b>	Jaguar XJ6, XJ & Sovereign; Daimler Sovereign (68 - Oct 86) up to D	<b>0242</b>	Peugeot 205 Petrol (83 - 97) A to P	<b>0932</b>
Fiat Bravo & Brava Petrol (95 - 00) N to W	<b>3572</b>	Jaguar XJ6 & Sovereign (Oct 86 - Sept 94) D to M	<b>3261</b>	Peugeot 206 Petrol & Diesel (98 - 01) S to X	<b>3757</b>
Fiat Cinquecento (93 - 98) K to R	<b>3501</b>	Jaguar XJ12, XJS & Sovereign; Daimler Double Six (72 - 88) up to F	<b>0478</b>	Peugeot 306 Petrol & Diesel (93 - 99) K to T	<b>3073</b>
Fiat Panda (81 - 95) up to M	<b>0793</b>	<b>JEEP</b> Cherokee Petrol (93 - 96) K to N	<b>1943</b>	Peugeot 307 Petrol & Diesel (01 - 04) Y-reg. onwards	<b>4147</b>
Fiat Punto Petrol & Diesel (94 - Oct 99) L to V	<b>3251</b>	<b>LADA</b> 1200, 1300, 1500 & 1600 (74 - 91) up to J	<b>0413</b>	Peugeot 309 Petrol (86 - 93) C to K	<b>1266</b>
Fiat Punto Petrol (Oct 99 - July 03) V-reg onwards	<b>4066</b>				

\* Classic reprint

Title	Book No.	Title	Book No.	Title	Book No.
Peugeot 405 Petrol (88 - 97) E to P	1559	Talbot Horizon Petrol (78 - 86) up to D	0473	Volkswagen Golf & Jetta Mk 2 Petrol (Mar 84 - Feb 92) A to J	1081
Peugeot 405 Diesel (88 - 97) E to P	3198	Talbot Samba (82 - 86) up to D	0823	Volkswagen Golf & Vento Petrol & Diesel (Feb 92 - Mar 98) J to R	3097
Peugeot 406 Petrol & Diesel (96 - Mar 99) N to T	3394	TOYOTA Carina E Petrol (May 92 - 97) J to P	3256	Volkswagen Golf & Bora 4-cyl Petrol & Diesel (01 - 03) X to 53	4169
Peugeot 406 Petrol & Diesel (Mar 99-02) T-reg. on	3982	Toyota Corolla (80 - 85) up to C	0683	Volkswagen LT Petrol Vans & Light Trucks (76 - 87) up to E	0637
Peugeot 505 Petrol (79 - 89) up to G	0762	Toyota Corolla (Sept 83 - Sept 87) A to E	1024	Volkswagen Passat & Santana Petrol (Sept 81 - May 88) up to E	0814
Peugeot 1.7/1.8 & 1.9 litre Diesel Engine (82 - 96) up to N	0950	Toyota Corolla (Sept 87 - Aug 92) E to K	1683	Volkswagen Passat 4-cyl Petrol & Diesel (May 88 - 96) E to P	3498
Peugeot 2.0, 2.1, 2.3 & 2.5 litre Diesel Engines (74 - 90) up to H	1607	Toyota Corolla Petrol (Aug 92 - 97) K to P	3259	Volkswagen Passat 4-cyl Petrol & Diesel (Dec 96 - Nov 00) P to X	3917
PORSCHE 911 (65 - 85) up to C	0264	Toyota Hi-Ace & Hi-Lux Petrol (69 - Oct 83) to A	0304	Volkswagen Polo & Derby (76 - Jan 82) up to X	0335
Porsche 924 & 924 Turbo (76 - 85) up to C	0397	TRIUMPH GT6 & Vitesse (62 - 74) up to N *	0112	Volkswagen Polo (82 - Oct 90) up to H	0813
Porsche 924 & 924 Turbo (76 - 85) up to C	0397	Triumph Herald (59 - 71) up to K *	0010	Volkswagen Polo Petrol (Nov 90 - Aug 94) H to L	3245
PROTON (89 - 97) F to P	3255	Triumph Spitfire (62 - 81) up to X	0113	Volkswagen Polo Hatchback Petrol & Diesel (94 - 99) M to S	3500
RANGE ROVER V8 Petrol (70 - Oct 92) up to K	0606	Triumph Stag (70 - 78) up to T *	0441	Volkswagen Polo Hatchback Petrol (00 - Jan 02) V to 51	4150
RELIANT Robin & Kitten (73 - 83) up to A *	0436	Triumph TR2, TR3, TR3A, TR4 & TR4A (52 - 67) up to F *	0028	Volkswagen Scirocco (82 - 90) up to H *	1224
RENAULT 4 (61 - 86) up to D *	0072	Triumph TR5 & 6 (67 - 75) up to P *	0031	Volkswagen Transporter 1600 (68 - 79) up to V	0082
Renault 5 Petrol (Feb 85 - 96) B to N	1219	Triumph TR7 (75 - 82) up to Y *	0322	Volkswagen Transporter 1700, 1800 & 2000 (72 - 79) up to V *	0226
Renault 9 & 11 Petrol (82 - 89) up to F	0822	VAUXHALL Astra Petrol (80 - Oct 84) up to B	0635	Volkswagen Transporter (air-cooled) Petrol (79 - 82) up to Y *	0638
Renault 18 Petrol (79 - 86) up to D	0598	Vauxhall Astra & Belmont Petrol (Oct 84 - Oct 91) B to J	1136	Volkswagen Transporter (water-cooled) Petrol (82 - 90) up to H	3452
Renault 19 Petrol (89 - 96) F to N	1646	Vauxhall Astra Petrol (Oct 91 - Feb 98) J to R	1832	Volkswagen Type 3 (63 - 73) up to M *	0084
Renault 19 Diesel (89 - 96) F to N	1946	Vauxhall/Opel Astra & Zafira Petrol (Feb 98 - Apr 04) R-reg onwards	3758	VOLVO 120 & 130 Series (& P1800) (61 - 73) up to M *	0203
Renault 21 Petrol (86 - 94) C to M	1397	Vauxhall/Opel Astra & Zafira Diesel (Feb 98 - Apr 04) R-reg onwards	3797	Volvo 142, 144 & 145 (66 - 74) up to N *	0129
Renault 25 Petrol & Diesel (84 - 92) B to K	1228	Vauxhall/Opel Calibra (90 - 98) G to S	3502	Volvo 240 Series Petrol (74 - 93) up to K	0270
Renault Clio Petrol (91 - May 98) H to R	1853	Vauxhall Carlton Petrol (Oct 78 - Oct 86) up to D	0480	Volvo 262, 264 & 260/265 (75 - 85) up to C *	0400
Renault Clio Diesel (91 - June 96) H to N	3031	Vauxhall Carlton & Senator Petrol (Nov 86 - 94) D to L	1469	Volvo 340, 343, 345 & 360 (76 - 91) up to J	0715
Renault Clio Petrol & Diesel (May 98 - May 01) R to Y	3906	Vauxhall Cavalier Petrol (81 - Oct 88) up to F	0812	Volvo 440, 460 & 480 Petrol (87 - 97) D to P	1691
Renault Clio Petrol & Diesel (June 01 - 04) Y-reg. onwards	4168	Vauxhall Cavalier Petrol (Oct 88 - 95) F to N	1570	Volvo 740 & 760 Petrol (82 - 91) up to J	1258
Renault Espace Petrol & Diesel (85 - 96) C to N	3197	Vauxhall Chevette (75 - 84) up to B	0285	Volvo 850 Petrol (92 - 96) J to P	3260
Renault Laguna Petrol & Diesel (94 - 00) L to W	3252	Vauxhall/Opel Corsa Diesel (Mar 93 - Oct 00) K to X	4087	Volvo 940 Petrol (90 - 96) H to N	3249
Renault Mégane & Scénic Petrol & Diesel (96 - 98) N to R	3395	Vauxhall Corsa Petrol (Mar 93 - 97) K to R	1985	Volvo S40 & V40 Petrol (96 - Mar 04) N-reg. onwards	3569
Renault Mégane & Scénic Petrol & Diesel (Apr 99 - 02) T-reg. onwards	3916	Vauxhall/Opel Corsa Petrol (Apr 97 - Oct 00) P to X	3921	Volvo S70, V70 & C70 Petrol (96 - 99) P to V	3573
ROVER 213 & 216 (84 - 89) A to G	1116	Vauxhall/Opel Corsa Petrol & Diesel (Oct 00 - Sept 03) X-reg onwards	4079		
Rover 214 & 414 Petrol (89 - 96) G to N	1689	Vauxhall/Opel Frontera Petrol & Diesel (91 - Sept 98) J to S	3454		
Rover 216 & 416 Petrol (89 - 96) G to N	1830	Vauxhall Nova Petrol (83 - 93) up to K	0909		
Rover 211, 214, 216, 218 & 220 Petrol & Diesel (Dec 95 - 99) N to V	3399	Vauxhall/Opel Omega Petrol (94 - 99) L to T	3510		
Rover 25 & MG ZR Petrol & Diesel (Oct 99 - 04) V-reg. onwards	4145	Vauxhall/Opel Vectra Petrol & Diesel (95 - Feb 99) N to S	3396		
Rover 414, 416 & 420 Petrol & Diesel (May 95 - 98) M to R	3453	Vauxhall/Opel Vectra Petrol & Diesel (Mar 99 - May 02) T-reg. onwards	3930		
Rover 618, 620 & 623 Petrol (93 - 97) K to P	3257	Vauxhall/Opel 1.5, 1.6 & 1.7 litre Diesel Engine (82 - 96) up to N	1222		
Rover 820, 825 & 827 Petrol (86 - 95) D to N	1380	VOLKSWAGEN 411 & 412 (68 - 75) up to P *	0091		
Rover 3500 (76 - 87) up to E *	0365	Volkswagen Beetle 1200 (54 - 77) up to S	0036		
Rover Metro, 111 & 114 Petrol (May 90 - 98) G to S	1711	Volkswagen Beetle 1300 & 1500 (65 - 75) up to P	0039		
SAAB 95 & 96 (66 - 76) up to R *	0198	Volkswagen Beetle 1302 & 1302S (70 - 72) up to L *	0110		
Saab 90, 99 & 900 (79 - Oct 93) up to L	0765	Volkswagen Beetle 1303, 1303S & GT (72 - 75) up to P	0159		
Saab 900 (Oct 93 - 98) L to R	3512	Volkswagen Beetle Petrol & Diesel (Apr 99 - 01) T-reg. onwards	3798		
Saab 9000 (4-cyl) (85 - 98) C to S	1686	Volkswagen Golf & Bora Petrol & Diesel (April 98 - 00) R to X	3727		
Saab 9-5 4-cyl Petrol (97 - 04) R-reg onwards	4156	Volkswagen Golf & Jetta Mk 1 Petrol 1.1 & 1.3 (74 - 84) up to A	0716		
SEAT Ibiza & Cordoba Petrol & Diesel (Oct 93 - Oct 99) L to V	3571	Volkswagen Golf, Jetta & Scirocco Mk 1 Petrol 1.5, 1.6 & 1.8 (74 - 84) up to A	0726		
Seat Ibiza & Malaga Petrol (85 - 92) B to K	1609	Volkswagen Golf & Jetta Mk 1 Diesel (78 - 84) up to A	0451		
SKODA Estelle (77 - 89) up to G	0604				
Skoda Favorit (89 - 96) F to N	1801				
Skoda Felicia Petrol & Diesel (95 - 01) M to X	3505				
SUBARU 1600 & 1800 (Nov 79 - 90) up to H *	0995				
SUNBEAM Alpine, Rapier & H120 (67 - 74) to N *	0051				
SUZUKI SJ Series, Samurai & Vitara (4-cyl) Petrol (82 - 97) up to P	1942				
TALBOT Alpine, Solara, Minx & Rapier (75 - 86) up to D	0337				

#### AUTOMOTIVE TECHBOOKS

Automotive Air Conditioning Systems	3740
Automotive Electrical and Electronic Systems	3049
Automotive Gearbox Overhaul Manual	3473
Automotive Service Summaries Manual	3475
Automotive Timing Belts Manual - Austin/Rover	3549
Automotive Timing Belts Manual - Ford	3474
Automotive Timing Belts Manual - Peugeot/Citroën	3568
Automotive Timing Belts Manual - Vauxhall/Opel	3577

#### DIY MANUAL SERIES

Haynes Manual on Bodywork	4198
Haynes Manual on Brakes	4178
Haynes Manual on Carburettors	4177
Haynes Manual on Diesel Engines	4174
Haynes Manual on Engine Management	4199
Haynes Manual on Fault Codes	4175
Haynes Manual on Practical Electrical Systems	4267
Haynes Manual on Small Engines	4250
Haynes Manual on Welding	4176

\* Classic reprint

All the products featured on this page are available through most motor accessory shops, cycle shops and book stores. Our policy of continuous updating and development means that titles are being constantly added to the range. For up-to-date information on our complete list of titles, please telephone: (UK) +44 1963 442030 • (USA) +1 805 498 6703 • (France) +33 1 47 17 66 29 • (Sweden) +46 18 124016 • (Australia) +61 3 9763 8100



## Preserving Our Motoring Heritage



< The Model J Duesenberg Derham Tourster. Only eight of these magnificent cars were ever built - this is the only example to be found outside the United States of America

Almost every car you've ever loved, loathed or desired is gathered under one roof at the Haynes Motor Museum. Over 300 immaculately presented cars and motorbikes represent every aspect of our motoring heritage, from elegant reminders of bygone days, such as the superb Model J Duesenberg to curiosities like the bug-eyed BMW Isetta. There are also many old friends and flames. Perhaps you remember the 1959 Ford Popular that you did your courting in? The magnificent 'Red Collection' is a spectacle of classic sports cars including AC, Alfa Romeo, Austin Healey, Ferrari, Lamborghini, Maserati, MG, Riley, Porsche and Triumph.

### A Perfect Day Out

Each and every vehicle at the Haynes Motor Museum has played its part in the history and culture of Motoring. Today, they make a wonderful spectacle and a great day out for all the family. Bring the kids, bring Mum and Dad, but above all bring your camera to capture those golden memories for ever. You will also find an impressive array of motoring memorabilia, a comfortable 70 seat video cinema and one of the most extensive transport book shops in Britain. The Pit Stop Cafe serves everything from a cup of tea to wholesome, home-made meals or, if you prefer, you can enjoy the large picnic area nestled in the beautiful rural surroundings of Somerset.



> John Haynes O.B.E., Founder and Chairman of the museum at the wheel of a Haynes Light 12.



< Graham Hill's Lola Cosworth Formula 1 car next to a 1934 Riley Sports.



The Museum is situated on the A359 Yeovil to Frome road at Sparkford, just off the A303 in Somerset. It is about 40 miles south of Bristol, and 25 minutes drive from the M5 intersection at Taunton.

Open 9.30am - 5.30pm (10.00am - 4.00pm Winter) 7 days a week, *except Christmas Day, Boxing Day and New Years Day*

Special rates available for schools, coach parties and outings Charitable Trust No. 292048



# SEE HAYNES, SEE HOW

Written from hands-on experience gained from the complete strip-down and rebuild of several Berlingos and Partners in our Project Workshop, this manual can help you understand, care for and repair your Berlingo or Partner. We do it ourselves to help you do-it-yourself, and whatever your mechanical ability, the practical step-by-step explanations, linked to over 900 photos, will help you get the job done right. Regular servicing and maintenance of your Berlingo or Partner can help maintain its resale value, save you money, and make it safer to drive.

**HAYNES MANUALS EXPLAIN BEST - SEE HAYNES, SEE HOW**



## Inside this Manual

**Maintenance** Simple weekly checks to keep you on the road

**Servicing** Complete, fully illustrated step-by-step guide

**Fault finding** Pinpoint specific problems easily

**The MoT** Step-by-step test checks

**Brakes** Safety checks and repairs for the home mechanic

**Electrics** Easy-to-read wiring diagrams

**Haynes tips** Valuable short cuts make many tasks easier

**OVER 150  
MILLION  
HAYNES MANUALS  
SOLD WORLDWIDE**

"...it's the paper equivalent of talking to a mate who's happy to help... a great way for owners to save cash by tackling jobs themselves..."

*Auto Express*

"...knowledge is power, and that knowledge is in your workshop manual..."

*Practical Classics*

"...Haynes manuals are legendary..."

*Daily Mirror*

"...The unique nature of a Haynes Manual - with each one written and photographed from the hands-on experience gained by a complete teardown and rebuild of the vehicle - continues to set Haynes Manuals apart from all others..."

*The Motor Bookstore.com*

ISBN 1 84425 281 7



9 781844 252817

## Models covered by this Manual

Citroën Berlingo Multispace & Van and Peugeot Partner Combi & Van, including special/limited editions

**Petrol engines:** 1.4 litre (1360cc) & 1.6 litre (1587cc)

**Diesel engines:** 1.8 litre (1769cc), 1.9 litre (1868cc) & 2.0 litre (1997cc), inc. turbo

Does NOT cover models with 1.8 litre (1761cc) petrol

Haynes Publishing, Sparkford, Yeovil, Somerset BA22 7JJ England

**A**

UPC CODE



RST

[www.haynes.co.uk](http://www.haynes.co.uk)