

2011 Audi A3

Owner's Manual



Introduction

Thank you for choosing an Audi A3 - we value your trust in us.

Your new Audi A3 incorporates the newest technology as well as numerous features designed for your comfort, convenience and safety. We recommend you read your Owner's Manual thoroughly so that you can quickly become acquainted with your Audi.

In addition to explaining how the different features work, we also give you many useful tips and information concerning your safety and that of your passengers, how to care for your vehicle and maintain your vehicle's value.

We hope you enjoy driving your Audi A3 and we wish you safe and pleasant motoring.

AUDI AG

Table of contents

Vehicle literature	4	Clear vision	56	Safety first	124
About this Owner's Manual	5	Lights	56	Driving Safely	124
Controls and equipment	6	Interior lights	60	General notes	124
Instruments and controls	7	Vision	63	Proper occupant seating positions	126
General illustration	7	Mirrors	63	Pedal area	130
Instruments and warning/indicator lights	8	Wiper and washer system	65	Stowing luggage	131
Instruments	8	Digital compass	71	Reporting Safety Defects	133
Warning/indicator lights	11	Seats and storage	73	Safety belts	135
Driver information display	18	General recommendations	73	General notes	135
Introduction	18	Adjusting front seats manually	74	Why safety belts?	136
On-Board Diagnostic system (OBD)	20	Adjusting the power seat	75	Safety belts	139
Trip computer	21	Adjusting the lumbar support	77	Safety belt pretensioners	143
Menu display	22	Head restraints	77	Airbag system	145
Efficiency program	25	Center armrest	79	Important things to know	145
Service interval display	27	Rear seats	80	Front airbags	149
Speed warning system	28	Luggage compartment	81	Monitoring the Advanced Airbag System	156
Warnings and symbols	30	Roof rack* installation	86	Side airbags	161
Opening and closing	38	Cup holders	89	Side curtain airbags	164
Keys	38	Socket	90	Child Safety	167
Power locking system	40	Storage	91	Important things to know	167
Doors, power locks	43	Warm and cold	95	Child safety seats	172
Power windows	49	Climate controls	95	Installing a child safety seat	177
Panoramic sliding sunroof	51	Electrically heated front seats	103	LATCH Lower anchorages and tethers for children	180
Emergency mechanical closing for the panoramic sliding sunroof	53	Engine preheater	103	Additional Information	186
		On the road	105		
		Steering	105		
		Ignition lock and ignition switch	106		
		Starting and stopping the engine	107		
		Parking brake	108		
		Starting on hills	110		
		Cruise control	110		
		Audi magnetic ride	112		
		Transmission	114		
		Manual transmission	114		
		S tronic transmission	115		

Vehicle operation	188	Engine cooling system	234	Data	296
Intelligent technology	188	Brake fluid	237	200 hp, 2.0 liter 4-cyl. turbo gasoline engine	296
Notice about data recorded by vehicle control modules	188	Battery	238	140 hp, 2.0 TDI liter 4-cyl. turbo clean diesel engine	298
Electronic Stabilization Program (ESP)	188	Windshield washer container ...	243	Consumer Information	299
Braking	191	Tires and wheels	245	Warranty coverages	299
Electro-mechanical power assist	193	Tires	245	Operating your vehicle outside the U.S.A. or Canada	299
Driving with your quattro®	194	Tire pressure monitoring system	264	Audi Service Repair Manuals and Literature	299
Energy management	194	Do-it-yourself service .	270	Maintenance	299
Driving and environment	197	What do I do now?	270	Additional accessories, modifications and parts replacement	301
The first 1,000 miles (1,500 km) and afterwards	197	Jack, tools and spare wheel	270	Alphabetical index	304
Catalytic converter	198	Compact spare wheel	271		
Diesel particulate filter	199	Wheel change	272		
Avoid damaging the vehicle	199	Fuses and bulbs	281		
Operate your vehicle economically and minimize pollution	200	Electrical fuses	281		
Trailer towing	202	Bulbs	285		
Driving with a trailer	202	Emergency situations	286		
Trailer towing tips	204	General	286		
Vehicle care	206	Starting by pushing or towing ..	286		
Cleaning and protection	206	Starting with jumper cables	286		
General information	206	General information of starting assistance	287		
Care of exterior	206	Use of jumper cables	288		
Care of interior	213	Emergency towing with commercial tow truck	289		
Fuel supply and filling your fuel tank	219	Lifting the vehicle	292		
Gasoline	219	Technical data	294		
Diesel fuel	220	General information	294		
Fuel tank	221	Explanation of technical data ...	294		
Checking and filling	225	Vehicle identification	294		
Engine hood	225	Weights	295		
Engine compartment	227	Dimensions	295		
Engine oil	228				

Vehicle literature

In addition to this Owner's Manual, your Audi comes with a Warranty & Maintenance booklet.

Moreover, depending on the model and the equipment, there may be additional instruction booklets delivered with your vehicle (for example, Operating Instructions for your Sound System, Navigation System etc.).

If you are missing one of these publications or if you believe that the information is not complete, contact your authorized Audi dealer for assistance.

The Warranty & Maintenance booklet

explains how you can keep your Audi in top driving condition by having it serviced regularly and contains detailed information about the warranties covering your Audi. Always have the booklet with you when you take your vehicle to an authorized Audi dealer for service. Your Audi Service Adviser will record each scheduled service and can answer any questions you may have regarding how to maintain your vehicle.

In Canada,

the vehicle literature is also available in French. To obtain a copy, contact your dealer or write to:

Au Canada, on peut se procurer un exemplaire en français de ce document auprès du concessionnaire ou de:

Volkswagen Canada, Inc.
Client Assistance
Assistance à la Clientèle
777 Bayly Street, West,
Ajax, Ontario L1S 7G7

If you sell your Audi

all literature should be left in the vehicle to make the Warranty terms as well as all operating, safety, and maintenance information available to the next owner.

If you change your address or if you bought this Audi used

be sure to send in a "Notice of Address Change" / "Notice of Used Car Purchase" post card. This card can be found in the Warranty & Maintenance booklet or obtained from your authorized Audi dealer.

It is in your own interest that we are able to contact you should the need arise. ■

About this Owner's Manual

This owner's manual contains important information, tips, suggestions, and warnings for the use of your vehicle.

Make sure that this owner's manual is always located in the vehicle. This is especially important if you allow other people to drive the vehicle, or if you sell it.

This owner's manual describes the **equipment range** specified for this model at the editorial deadline date. Some of the equipment described here will only be available at a later date, or only in specific markets.

Some sections in this owner's manual do not apply to all vehicles. In that case, the **range of applicability** is given at the beginning of the section, e. g. "Applies to vehicles: with parking system". In addition, optional equipment is indicated by an asterisk "*".

The details in the **illustrations** may be different from those in your vehicle, and are intended to be viewed as a basic guide.

You will find a **table of contents** at the beginning of this book, which displays all topics described in this manual in order of appearance. You will find an alphabetical **index** at the end of this book.

All **directions**, such as "left", "right", "front", "back", are relative to the direction of travel.

* optional equipment

► This section continues on the next page.

■ Indicates the **end of a section**.

® Registered trademarks are identified with a ®. If this symbol is missing, it is no guarantee that the terms can be used freely.

⇒ ⚠ Cross-reference to a "WARNING!" within a section. For indication with a page number, the corresponding "WARNING!" can be found outside of the section.



WARNING

Text with this symbol contains important information on safety and how to reduce the risk of personal injury or death.



Note

Text with this symbol draws your attention to potential sources of damage to your vehicle.



For the sake of the environment

Text with this symbol contains information about the environment and how you can help protect it.



Tips

Text with this symbol contains special tips and other information about getting the most out of your vehicle and its features. ■

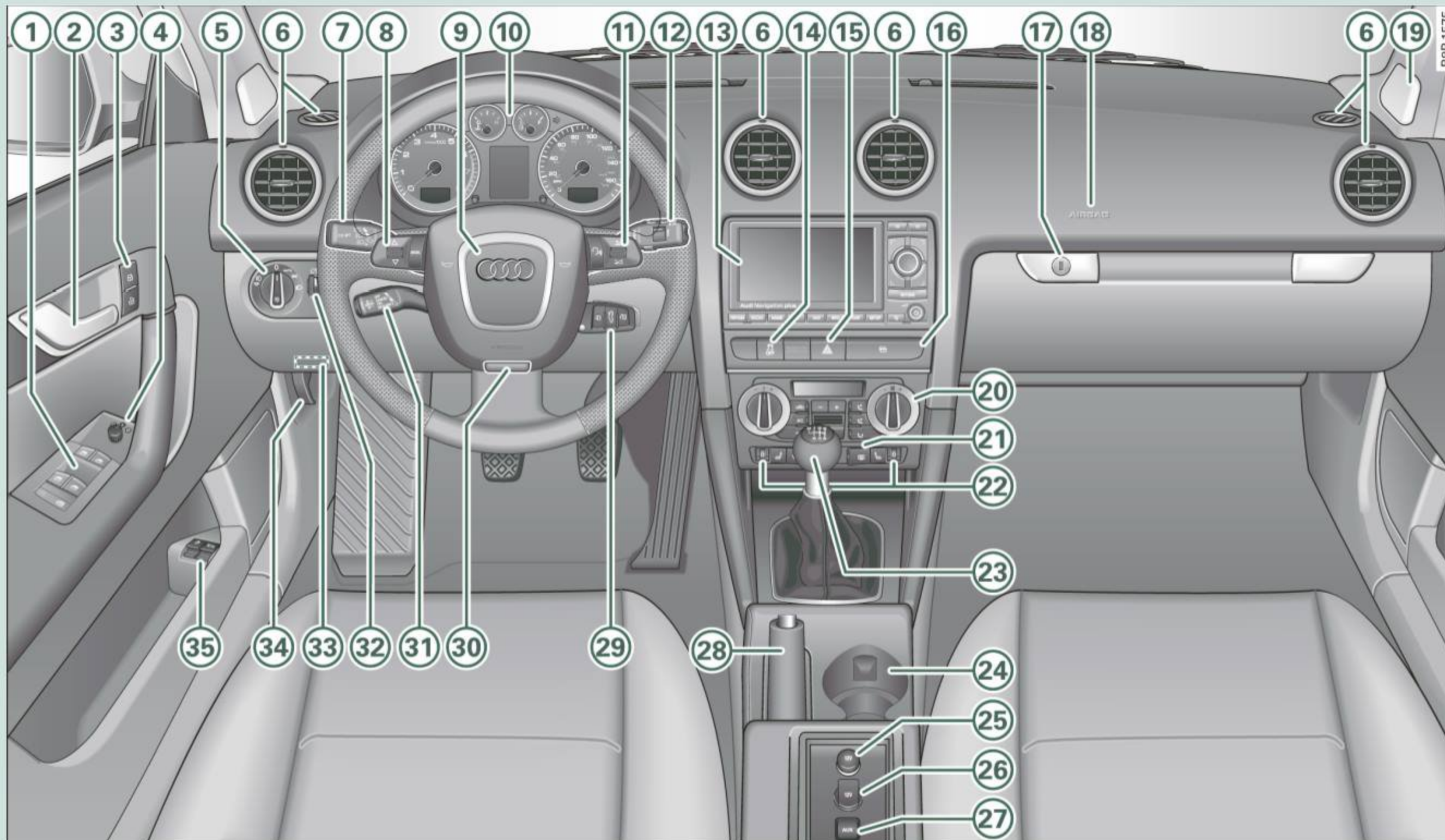

Fig. 1 Some of the equipment or features shown in the general illustration may be standard equipment on your vehicle or may be optional equipment depending on your model. Always ask your authorized Audi dealer if you have a question about your vehicle.

Instruments and controls

General illustration

① Power window switches	49	⑲ Loudspeaker (treble)	
② Door handle		⑳ Climate controls	97
③ Power locking switch	44	㉑ Rear window defogger switch	102
④ Switches for:		㉒ Switch for seat heating	103
– Adjuster for outside mirrors	65	㉓ Gear shift lever or selector lever	
– Switching on heated exterior mirrors		– Manual transmission	114
⑤ Light switch	56	– Automatic transmission	115
⑥ Air outlets	101	㉔ Cup holder	89
⑦ Turn signal and high beam	59	㉕ Electrical socket	90
⑧ Radio control buttons		㉖ Electrical socket	90
⑨ Steering wheel with:		㉗ AUX-in connection	
– Integrated control buttons (<i>multi-function steering wheel only</i>) for Audi Sound System		㉘ Parking brake lever	108
– Horn		㉙ Ignition lock	106
– Driver's airbag	149	㉚ Adjustable steering column	105
⑩ Instrument cluster	8	㉛ Cruise control	110
⑪ Radio and telephone control buttons		㉜ Instrument lighting	58
⑫ Switches for		㉝ Data Link Connector for On Board Diagnostic (OBD II)	20
– Windshield wiper/washer	65	㉞ Release lever for the engine hood	225
– Trip computer	21	㉟ Switches for:	
⑬ Depending on options: Radio or Navigation system (navigation, radio, CD changer)		– Fuel flap release	222
⑭ Switches for Electronic Stabilization Program (ESP) ...	188	– Rear hatch release	45
⑮ Emergency flasher	92		
⑯ Storage tray or switch for	92		
– Audi magnetic ride	12		
⑰ Glove compartment (lockable)	92		
⑱ Front passenger's airbag	149		



Tips

A separate Owner's Manual is in vehicles that have a factory-installed radio, CD changer, navigation system, AUX-in connection or multi-function steering wheel. ■

Instruments and warning/indicator lights

Instruments

Instrument cluster and controls

The instrument cluster is your central source of information.

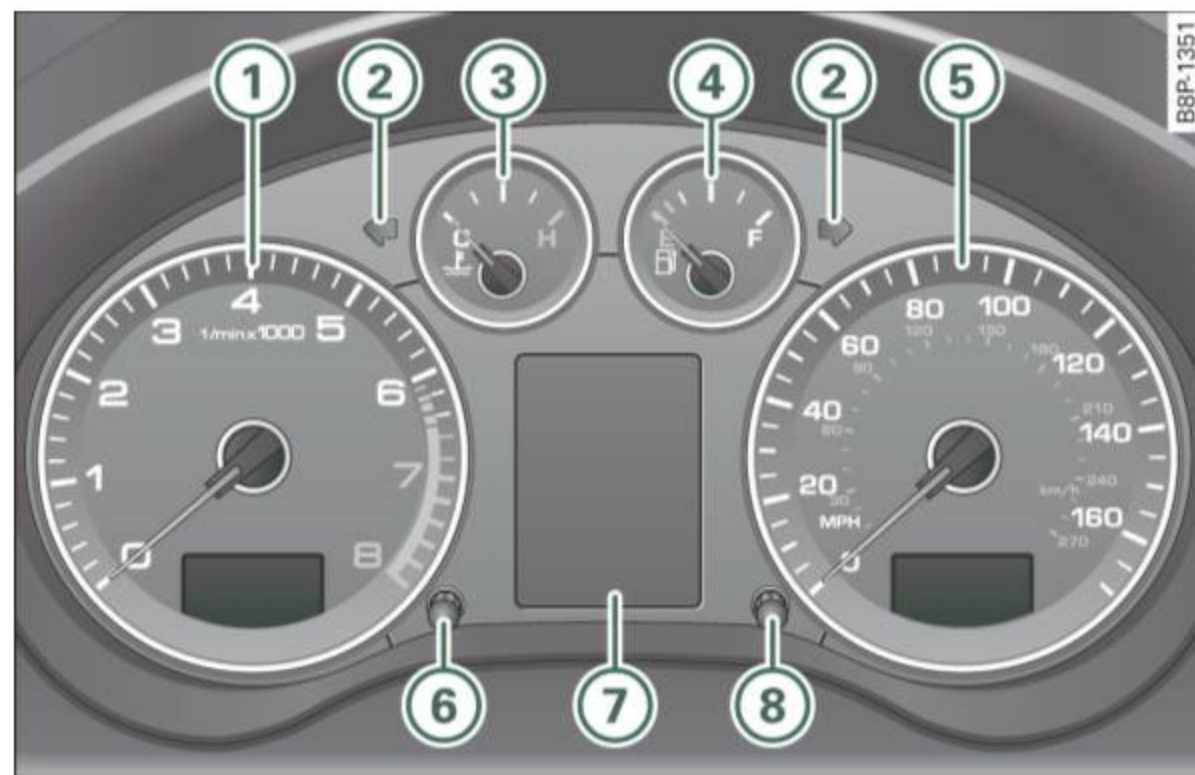

Fig. 2 Overview of the instrument cluster

① Tachometer with time and date display	8, 9
② Indicator lights (turn signals)	11
③ Coolant temperature gauge	9
④ Fuel gauge	10
⑤ Speedometer with odometer	10
⑥ Set/Check button	9, 31
⑦ Warning/indicator lights	11
⑧ Reset button for	

– Trip odometer	10
– Service interval display	27

! Note

The instrument cluster and center console illumination (gauges and needles) comes on when you switch on the ignition and the **vehicle headlights are off**. Be aware of the following difference between models built to US or Canadian specifications:

- **USA models:** illumination of the instrument cluster (gauges and needles), dash and center console around the gearshift lever is controlled by a light sensor located in the instrument panel. The instrument panel illumination will automatically become dimmer as the daylight fades away and eventually will go out completely when outside light is very low. This is to remind you, the driver, to switch on the headlights before it gets too dark.
- **Canada models:** instrument panel illumination will stay bright regardless of the intensity of ambient light. Always be aware of changes in outside light conditions while you are driving. Respond in time to fading daylight by turning the light switch to position  (or “AUTO” if your car is equipped with this feature) to turn on your headlights. ■

Tachometer (engine rev counter)

The tachometer indicates the engine RPM (revolutions per minutes).

The tachometer ① ⇒ fig. 2 is the left one of the two large clock-type displays.

The engine turns at a speed 1 000 times the single digit in the display, e.g. if the needle points at the “2”, the engine turns at 2 000 RPM.

If the engine RPMs drop below 1 500, you should downshift to the next lower gear. The red area at the end of the scale indicates maximum permissible engine RPMs after the break-in period. Before reaching this area, you should either shift into the next higher gear or ease your foot off the accelerator pedal.

! Note

The tachometer needle ⇒ *page 8, fig. 2* ① should not move into the red range. If it does, then only for a very short period of time. You could damage your engine by driving at high RPM!

🌱 For the sake of the environment

Upshifting early saves fuels and reduces engine noise. ■

Digital clock with date display

Your vehicle is equipped with a quartz controlled digital clock.



Fig. 3 Instrument cluster with: the digital clock and date

To set the hour

- Pull the knob (hour display flashes) and turn it to the left or right.

To set the minutes

- Pull the button until the minute display flashes.
- Turn the knob to the left or right until the desired setting appears.

To set the time format (12 or 24-hour display)

- Pull the knob until the time format display flashes.
- Turn the knob to the left or right.

To set the date

- Pull the knob until the day, month or year display flashes.
- Turn the knob to the left or right.

To show or hide the date display

- Pull the knob until the date display flashes.
- Turn the knob to the left or right.

When the date display stops flashing, this means the time and date have been successfully stored.

With the ignition off, pressing the button ⇒ *fig. 3* - depending on the instrument cluster configuration - can turn on the display field lighting for a few seconds. ■

Engine coolant temperature gauge

The engine coolant gauge ③ ⇒ *page 8, fig. 2* only works when the ignition is on. To prevent damage to your engine, please note the following important points: ▶

Engine cold

As long as the needle remains at the left end of the gauge, the engine still has not reached its operating temperature. Avoid high engine speeds, heavy engine loads and heavy throttle.

Normal temperature

When the engine has reached its operating temperature, the needle will move into the middle of the gauge and remain there. If the engine is working hard at high outside temperatures, the needle may turn further to the right. This is no cause for concern as long as the  warning light in the instrument cluster does not illuminate.

When the  warning light starts to flash, this can mean one of two things: either the coolant *temperature* is too high, or the coolant *level* is too low ⇒ *page 32*.

WARNING

- Always observe the warning in ⇒ *page 218*, “Engine compartment” before opening the engine hood and checking the engine coolant level.
- Never open the engine hood if you see or hear steam, or if you see engine coolant dripping from the engine compartment. You could burn yourself. Let the engine cool off first so that you cannot hear or see any steam or engine coolant.

Note

- Mounting additional lights or accessories in front of the air inlets reduces the cooling effect of the radiator. At high outside temperatures or high engine load, the engine could overheat.
- The front spoiler has been designed to properly distribute the cooling air when the vehicle is moving. If the spoiler is damaged, this could reduce the cooling effect and the engine could then overheat. Ask your authorized Audi dealer for assistance. ■

Fuel gauge

The fuel gauge works only when the ignition is on.

When the needle reaches the red area, the warning light in the instrument cluster will illuminate ⇒ *page 34* . This means you have approximately 1.8 gallons (7 liters) of fuel left in the tank. **Time to refuel!**

The total tank capacity of your vehicle is listed in ⇒ *page 296*, “Data”.

Note

Never run the tank completely dry! An irregular supply of fuel can cause engine misfiring and fuel could enter into the exhaust system. The catalytic converter could then overheat and be damaged. ■

Speedometer with odometer

The speedometer shows you the vehicle speed, and the odometer shows you how many miles (kilometers) you have driven.



Fig. 4 Speedometer close-up: odometer display

The odometer and trip odometer are located inside the speedometer.

- USA models – Miles
- Canadian models – Kilometers

Lower odometer

The lower odometer shows the total number of miles (kilometers) driven.

Upper odometer (trip odometer)

The upper odometer shows the total number of miles (kilometers) driven since you last reset the odometer back to zero. You can use this odometer when you want to keep track of how many miles (kilometers) you have driven for a single trip or errand. The last digit indicates 1/10 of a mile (100 metres). You can set the trip odometer back to zero by pressing the reset button ⇒ *page 10, fig. 4.*

Malfunction message

If there is a malfunction somewhere in the instrument cluster, **dEF** will appear in the trip odometer and will stay on. Contact your authorized Audi dealer to have the problem corrected.

Immobilizer

When the ignition is switched on, the data on the ignition key are scanned automatically.

If an unauthorized key was used, **SAFE** is displayed continuously in the odometer display field. The vehicle cannot be operated ⇒ *page 40.*

Tips

- The digital clock and the odometer are turned on for about 30 seconds when the driver's door is opened.
- When the ignition is turned off, the odometer reading and the digital clock with date display can be switched on for about 30 seconds by pressing the knob ⇒ *page 8, fig. 2* . ■

Warning/indicator lights



Overview













The warning/indicator lights indicate different functions or a possible malfunction.





Fig. 5 Instrument cluster with warning/indicator lights

Your vehicle is equipped with several important warning and indicator lights to help you monitor the continued reliable operation of your vehicle ⇒ .

	Audi magnetic ride	⇒ <i>page 12</i>
	Tire pressure too low	⇒ <i>page 13</i>
	Electronic power control (gasoline engine only)	⇒ <i>page 13</i>

	Glow plug system (diesel engine only) (alternative to EPC)	⇒ page 13
	Electronic stabilization program (ESP)	⇒ page 14
	USA models: Malfunction Indicator lamp (MIL)	⇒ page 14
	Canada models: Malfunction Indicator Lamp (MIL)	⇒ page 14
	High beam	⇒ page 14
	Left turn signal	⇒ page 14
	Right turn signal	⇒ page 14
	Electronic Stabilization Program (ESP)	⇒ page 14
CRUISE	USA models: Cruise control activated	⇒ page 14
	Canada models: Cruise control activated	⇒ page 14
	Airbag system	⇒ page 15
	Generator	⇒ page 15
	Safety belt	⇒ page 15
BRAKE	USA models: Brake system, parking brake set	⇒ page 15
	Canada models: Brake system, parking brake set	⇒ page 15

ABS	USA models: Anti-lock brake system (ABS)	⇒ page 16
	Canada models: Anti-lock brake system (ABS)	⇒ page 16
	Electro-mechanical power assist	⇒ page 17

WARNING

- Failure to heed warning lights and other important vehicle information may result in serious personal injury or vehicle damage.
- Whenever stalled or stopped for repair, move the vehicle a safe distance off the road, stop the engine, and turn on the emergency flasher ⇒ page 59.
- The engine compartment of any motor vehicle is a potentially hazardous area. Before you check anything in the engine compartment, stop the engine and let it cool down. Always exercise extreme caution when working under the engine hood ⇒ page 218, “Engine compartment”

Tips

- When a yellow warning symbol appears, *one* warning tone sounds. Check the function displayed as soon as possible.
- When a red symbol appears, *three* warning tones sound in succession. The symbol continues to flash until the fault has been corrected. ■

Applies to vehicles: with Audi magnetic ride

Audi magnetic ride

The indicator light monitors vehicle damping.

The indicator light  illuminates when the ignition is switched on as a function check.

**Tips**

If the indicator lamp illuminates while you are driving, there is a malfunction in the vehicle damping. The chassis should be inspected immediately by an authorized Audi dealer. ■

Applies to vehicles: with tire pressure monitoring system

Tire pressure monitoring system - telltale indicator lamp

The warning/indicator light appears in the event of a significant loss of air pressure.

The  warning/indicator light illuminates for a few seconds after the ignition is turned on as function check and then goes out.

If the  symbol appears, pressure is too low in at least one tire.

When the system detects a malfunction, the warning/indicator light will flash for approximately one minute and then remain continuously illuminated. This sequence will continue upon subsequent vehicle starts up as long as the malfunction exists. Contact your authorized Audi dealer and have the malfunction corrected.

For more information ⇒ page 264. ■

Electronic power control **EPC**

This warning/indicator light monitors the electronic power control.

The **EPC** warning/indicator light (Electronic Power Control) illuminates when you switch on the ignition as a function check.

**Tips**

If this warning/indicator light illuminates while you are driving, then there is a malfunction in the engine electronics. Have the malfunction

corrected as soon as possible by your authorized Audi dealer or qualified workshop. ■

Applies to vehicles: with diesel engine

Glow plug system / Engine malfunction

The indicator lamp lights up to show that the glow plugs are preheating. It flashes if there is an engine malfunction.

Warning light stays lit up

If the  indicator light illuminates, the glow plug system is active. You should start the engine immediately after the indicator light switches off. The indicator light only illuminates for approximately 1 second if the engine is warm or if the outside temperature is above 46 °F (8 °C).

There is a fault in the glow plug system if the warning light  does not light up when the engine is **cold**. Contact an authorized Audi dealer or a qualified workshop.

Warning light flashes

If a malfunction develops in the engine management system while you are driving, the glow plug light will flash . The engine should be checked by an authorized Audi dealer or a qualified workshop as soon as possible.

**WARNING**

If you do not pay attention to the warning lights that have come on, this could lead to personal injury or damage to your vehicle. ■

Electronic Stabilization Program (ESP) /

The warning/indicator light monitors the electronic stabilization program.

The warning/indicator light  has the following functions:

- it flashes while you are driving, when the ESP or the ASR (Anti-Slip Regulation) is working.
- it illuminates when you switch on the ignition for approximately 2 seconds as a function check.
- it illuminates when there is a malfunction in the ESP.
- it illuminates after the battery has been disconnected.
- it illuminates continuously when the ESP is switched off.
- it illuminates if there is a malfunction in the ABS, since the ESP is part of the ABS system.

If the ESP warning/indicator light illuminates and stays on after you have started the engine, this may mean that the control system has temporarily switched off the ESP. If this is the case, you can reactivate the ESP by switching the ignition off and then on again. The warning/indicator light should go out to show that the system is fully functional again.

The ESP warning/indicator light will illuminate when the ignition is switched on if the vehicle battery has been disconnected and then reconnected again. The light should go out after driving a short distance if the steering wheel is turned slightly.

For more information about the ESP ⇒ *page 188*. ■

Malfunction Indicator Lamp (MIL) (USA models)/ (Canada models)

The Malfunction Indicator Lamp (MIL) is part of the On-Board Diagnostic (OBD II) system. The symbol  lights up when the ignition is turned on and will turn off after the engine has started and has

settled at constant idle speed. This indicates that the MIL is working properly.

The warning light illuminates when there is a malfunction in the engine electronic system. Contact your authorized Audi dealer and have the malfunction corrected.



For more information ⇒ *page 20*. ■

High beam

The  warning/indicator light illuminates when the high beams are on or when you use the headlight flasher. For more information about using the high beams, see ⇒ *page 59*. ■

Turn signals

The indicator light flashes when you use either turn signal.

Whenever you use the left  or the right  turn signal, the indicator light flashes. When you use the emergency flasher, both indicator lights flash.

If one of the turn signal light bulbs burn out, the turn signal will flash twice as fast as normal. ■

Cruise control CRUISE (USA models)/ (Canada models)

The **CRUISE** warning/indicator light illuminates when the cruise control is activated. ■

Airbag system

This warning/indicator light monitors the airbag and the tensioner systems.

The  warning light illuminates for a few seconds each time you switch on the ignition.

If the  warning light does not go out, or if it illuminates while you are driving, or if it starts to flash, then there is a malfunction somewhere in the system. If the light does not illuminate when you switch on the ignition, this also means there is a malfunction.

WARNING

If you have a malfunction in the airbag system, contact your authorized Audi dealer immediately. Otherwise the airbag or the belt tensioner may not work properly in an accident. ■

Generator

This warning/indicator light detects a malfunction in the generator or in the vehicle's electrical system.

The  warning/indicator light illuminates when you switch on the ignition and must go out after the engine has started.

If the  warning/indicator light illuminates while you are driving, you should contact your authorized Audi dealer. Since the vehicle battery is discharging, you should switch off any unnecessary electrical consumers (for example, the air conditioner). ■

Safety belts

This warning/indicator light reminds you to put on your safety belt.

The  warning/indicator light illuminates when the ignition is switched on to remind the driver and (on USA models only) any front passenger to put on the safety belt. Additionally, an acoustic warning (gong) will also sound.



For more Information ⇒ *page 135*, “Safety belt warning light ”. ■

Brake system **BRAKE (USA)/ (Canada)**

This warning/indicator light illuminates when the brake fluid level is too low or when there is a malfunction in the ABS, or when the parking brake is set.

The light illuminates when the ignition is turned on. It goes out after the engine has been started and the parking brake is fully released. This indicates that the brake warning light is functioning properly.

If the brake warning light does not light up when the engine is cranking or the parking brake is applied, there may be a malfunction in the electrical system. In this case, contact your Audi dealer.

If the ABS fails, the ABS warning/indicator light **ABS** (USA models)/ (Canada models) flashes together with the brake system warning/indicator light ⇒ .



(USA models): If the warning light **BRAKE** and the warning light  illuminate together, immediately contact your authorized Audi dealer or qualified workshop to have all brake pads inspected ⇒ *page 35*.

When the light comes on, an audible warning signal is also given.

Parking brake set

The **BRAKE** warning/indicator light illuminates when the parking brake is set ⇒ .

 **WARNING**

- **USA models:** If both, the **BRAKE** warning light and the **ABS** warning light come on at the same time, the rear wheels could lock up first under hard braking. Lock-up of the rear wheel brakes can cause loss of vehicle control and an accident. Have your vehicle repaired immediately by your authorized Audi dealer or a qualified workshop. Drive slowly and avoid sudden, hard brake application.
- **Canada models:** If both, the brake warning light  and the ABS warning light  come on at the same time, the rear wheels could lock up first under hard braking. Lock-up of the rear wheel brakes can cause loss of vehicle control and an accident. Have your vehicle repaired immediately by your authorized Audi dealer or a qualified workshop. Drive slowly and avoid sudden, hard brake application
- If the brake warning/indicator light does not go out after a few seconds and the parking brake released, or lights up while you are driving, the fluid level in the brake fluid reservoir is too low. If you believe that it is safe to do so, proceed immediately at low speed to the nearest authorized Audi dealer or qualified workshop and have the brake system inspected.
- Please be very careful and always keep in mind that after several brake applications, you will need greater pressure on the brake pedal to stop your vehicle. Consequently, you must allow for increased braking distances. Trying to brake as quickly as usual could lead to an accident. ■

Anti-lock brake system **ABS** (USA)/ (Canada)

This warning/indicator light monitors the ABS and the electronic differential lock (EDL).

The **ABS** light will come on for a few seconds when the ignition is switched on. The light will go out after an automatic check sequence is completed.

There is a malfunction in the ABS when:



- The warning/indicator light does not illuminate when you switch on the ignition.
- The warning/indicator light does not go out after a few seconds.
- The warning/indicator light illuminates while driving.

The brake system will still respond even without the assistance of the ABS system. See your authorized Audi dealer as soon as possible to restore full braking performance. For more information regarding the ABS ⇒ *page 192*.

The ABS warning light and the brake warning light come on together. The ABS will not work and you will notice a change in braking response and performance.

Malfunction in the brake system

USA models: If both, the **BRAKE** warning light and the **ABS** warning light come on ⇒ *page 15* when the parking brake is released, there may be a malfunction in the ABS, and there may also be a malfunction in the brake system itself ⇒ .

Canada models: If both, the brake warning light  and the ABS warning light  come on ⇒ *page 15* when the parking brake is released, there may be a malfunction in the ABS, and there may also be a malfunction in the brake system itself ⇒ .



Malfunction in the electronic differential lock (EDL)

The two systems EDL and ABS work together. The **ABS** warning light will come on if there is a malfunction in the EDL system ⇒ *page 189*. See your authorized Audi dealer as soon as possible.



 **WARNING**

- If the **ABS** warning light does not go out, or if it comes on while driving, the ABS system is not working properly. The vehicle can then be stopped only with the brakes operating without ABS support. You will not have the protection ABS provides. Contact your Audi dealer as soon as possible.

 WARNING (continued)

- *USA models:* If both, the **BRAKE** warning light and the **ABS** warning light come on at the same time, the rear wheels could lock up first under hard braking. Lock-up of the rear wheel brakes can cause loss of vehicle control and an accident. Have your vehicle repaired immediately by your authorized Audi dealer or a qualified workshop. Drive slowly and avoid sudden, hard brake application.
- *Canada models:* If both, the brake warning light  and the ABS warning light  come on at the same time, the rear wheels could lock up first under hard braking. Lock-up of the rear wheel brakes can cause loss of vehicle control and an accident. Have your vehicle repaired immediately by your authorized Audi dealer or a qualified workshop. Drive slowly and avoid sudden, hard brake application ■

Electro-mechanical power assist /

If the indicator light illuminates while you are driving, there is a malfunction in the electro-mechanical steering. If the indicator light is showing , there may be a reduction in power steering assist. If the indicator light is showing , there may be a total loss of power steering assist. The steering must be inspected immediately by a qualified workshop ⇒ . With the engine not running (e.g. when the car is being towed), there is also no power assist available.

 **WARNING**

If there is a malfunction, the indicator light for the electro-mechanical power assist illuminates. Seek professional assistance. ■

Driver information display

Introduction

Introduction

The Driver information display inside the instrument cluster provides you, the driver, with important information.



Fig. 6 Instrument cluster: center display



Fig. 7 Wiper lever: controls for the menu display

Center display

With the ignition on, the display in the Driver Information System shows the following information:

- CD* inserted or Radio* station set

- Outside temperature*: At temperatures below 41 °F (+5 °C), a snowflake symbol appears in front of the temperature display ⇒ ⚠.
- Warning: front lid, door or engine compartment lid open: The display appears if the door, the engine compartment lid or front lid is not closed.
- Warning: close fuel tank cap: The Driver information display indicates when the filler cap is not secured or missing ⇒ page 222.

Additional functions

You can open the following functions in the Driver Information System display by pressing the **RESET** button ⇒ fig. 7 one or more times:

Trip computer	⇒ page 21
Digital speedometer*	
Menu display	⇒ page 22

The speed warning system is also displayed in the Driver Information System. You can read how to set it in ⇒ page 28.

Efficiency program

The efficiency program can help you to use less fuel ⇒ page 25.

Auto Check Control

Some functions and vehicle components are scanned for their operating status when you switch the ignition on and while you are driving. Malfunctions or required service procedures are signaled audibly and indicated by red and yellow illuminated symbols and reminders in the display ⇒ page 30.

! WARNING

- Never rely exclusively on the outside temperature display to determine if a road surface is icy or not. Keep in mind that road surfaces, especially bridges and overpasses, could be ice covered and slippery even at an outside temperature above 41 °F (+5 °C).
- Always remember, even if the “snowflake” symbol (ice warning) does not appear in the display, black ice could be on the road.
- Always reduce your speed and drive with special care in cold weather conditions when the chance of encountering icy road surfaces increases.

i Tips

- If the vehicle is stationary, or if you are driving at a very low speed, the temperature shown in the display might be slightly higher than the actual outside temperature. This is caused by the heat being radiated from the engine.
- On vehicles with S tronic, the reminders do not appear in the display until you select a gear.
- On vehicles with Audi Navigation system*, the displays may differ from their normal appearance during navigation. ■

Applies to vehicles: with gearshift indicator and manual transmission

Gearshift recommendation

This indicator can help conserve fuel.



Fig. 8 Gearshift recommendation

In order to become familiar with the gearshift indicator, begin driving as usual. If the current gear is not the best one for conserving fuel, the indicator will display the recommended gear. The display shows the current gear and the recommended gear ⇒ fig. 8.

- **Upshifting:** The display is to the **right** of the current gear if a **higher gear** is recommended.
- **Downshifting:** The display is to the **left** of the current gear if a **lower gear** is recommended.

Sometimes the indicator will recommend skipping a gear (3 ► 5).

! Note

This indicator should help you conserve fuel. It is not designed to recommend the correct gear in all driving situations. Only the driver can decide which gear is correct in certain driving situations such as when accelerating or driving on hills.

i Tips

- The display switches off when the clutch pedal is pressed. ►

- Gear shift recommendation can be deactivated in the driver information system ⇒ *page 22*. ■

On-Board Diagnostic system (OBD)

On-Board Diagnostics

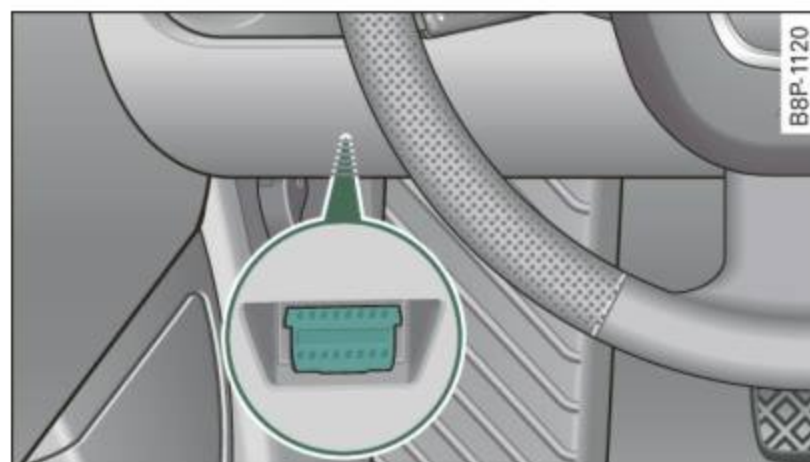

Fig. 9 Location of Data Link Connector (DLC)

On-Board Diagnostics monitors the components of your emission control system. Each controlled component in your engine system has been assigned a code. In case of a malfunction, the component will be identified and the fault stored as a code in the control module memory.

The MIL lamp may also illuminate if there is a leak in the on-board fuel vapor recovery system. If the light illuminates after a refuelling, pull off the road and stop the vehicle, then check that the fuel filler cap is properly closed ⇒ *page 222*.

In order to make an accurate diagnosis, the stored data can only be displayed using special diagnostic equipment (generic scan tool for OBD).

In order to connect the special diagnostic equipment, push the plug into the Data Link Connector (DLC). The DLC is located to the right of the engine hood release lever ⇒ *fig. 9*.

Your authorized Audi dealer or a qualified service station can interpret the code and perform the necessary repair. ■

Malfunction Indicator Lamp (MIL) (USA models)/ (Canada models)

The Malfunction Indicator Lamp (MIL)  in the instrument cluster ⇒ *page 11*, *fig. 5* is part of the On-Board Diagnostic (OBD II) system.

The warning/indicator light illuminates when the ignition is switched on and goes out after the engine starts and the idle has stabilized. This indicates that the MIL is working properly.

If the light does not go out after the engine is started, or illuminates while you are driving, a malfunction may exist in the engine system. If the light illuminates, the catalytic converter could be damaged.

Continue driving **with reduced power** (avoiding sustained high speeds and/or rapid accelerations) and have the condition corrected. Contact your authorized Audi dealer.

If the light illuminates, the electronic speed limiter may also be malfunctioning. For more information ⇒ *page 20*, “Electronic speed limiter”.

An improperly closed fuel filler cap may also cause the MIL light to illuminate ⇒ *page 222*. ■

Electronic speed limiter

Your vehicle may be factory equipped with tires that are rated for a maximum speed of 130 mph (210 km/h). This is less than the maximum speed of your vehicle. To reduce the risk of sudden tire failure and loss of control if the vehicle is operated at excessive speeds, your vehicle also has an electronic speed limiter. The electronic speed limiter prevents your vehicle from going faster than the tire speed rating. For more information ⇒ *page 259*, “Speed rating (letter code)”. ▶

If the engine control unit receives faulty vehicle roadspeed signals, the Malfunction Indicator Light (MIL)  will illuminate. If this occurs, contact the nearest authorized Audi dealer for assistance.

WARNING

Always observe the posted speed limits and adjust your speed to suit prevailing road, traffic and weather conditions. Never drive your vehicle faster than the maximum speed rating of the tires installed. ■

Trip computer

Introduction

The trip computer gives you information on current and average fuel mileage, average speed, fuel range and driving time.



Fig. 10 Trip computer 1

You can switch between the trip computer 1 and 2 by pressing the **Reset** button  ⇒ page 22, fig. 11.

You can tell which memory level is currently active by the number in the display ⇒ fig. 10. The data from the single-trip memory (memory level 1) is being displayed if a **1** appears in the display. If a **2** is shown,

then the data from the total-trip memory is being displayed (memory level 2).

Single-trip memory (Trip computer 1)

The single-trip memory stores the trip information from the time the ignition is turned on until it is turned off. If the trip is continued **within 2 hours** from the time the ignition was turned off, the new data will be included in the calculation of the current trip information. If the trip is interrupted for **more than 2 hours** the memory is reset automatically.

Total-trip memory (Trip computer 2)

Unlike the single-trip memory, the total-trip memory is not reset automatically. This permits you to evaluate your driving data for the entire period between manual resets.

Fuel range

The estimated cruising range in miles (km) appears in the display. The display changes in increments of 6 miles (10 km).

Average fuel mileage

The average fuel economy in MPG (l/100 km) since you last cleared the memory appears in this display.

Current fuel mileage

The instantaneous fuel consumption in miles per gallon (l/100 km) is shown in this display. When the vehicle is stationary, the most recent fuel consumption is displayed.

Average speed

The average speed in mph (km/h) since the last time the display was reset appears in the display.

Elapsed time

The length of time that you have been driving since you last reset the memory appears in this display. The maximum time period that can be recorded is 999 hours and 59 minutes. ►

Distance

The elapsed distance since the last time the memory was cleared appears in the display. The maximum distance that can be recorded is 9,999.9 miles (9,999.9 kilometers).

Tips

All stored values will be lost if the vehicle battery is disconnected. ■

Operation

The trip computer is controlled by two switches on the windshield wiper lever.

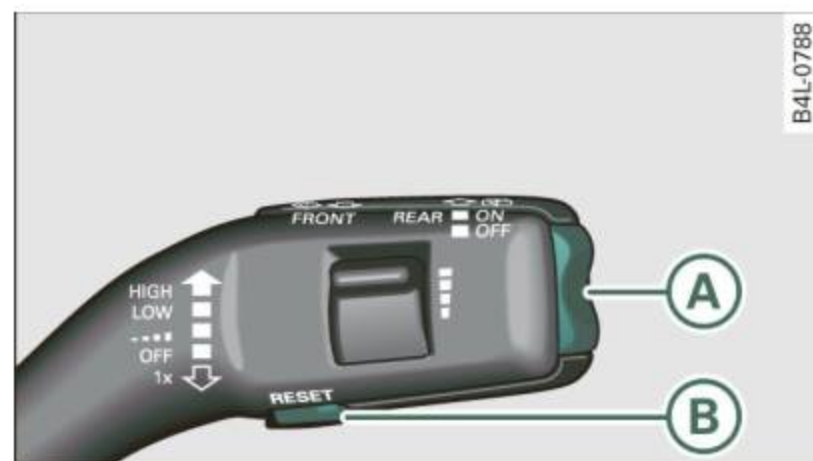

Fig. 11 Wiper arm/wiper lever: controls for the trip computer

Selecting the trip computer

- Tap the **Reset** button **B** until the trip computer (memory level 1 or 2) appears in the display ⇒ *page 21*, fig. 10.

Selecting the functions

- Push in the upper (lower) protrusion on the function selector switch **A** ⇒ fig. 11. The functions for the trip computer are displayed in succession on the respective memory levels.

Resetting the function to zero

- Push the **Reset** button **B** for at least two seconds.

You can reset the following values to zero using the **Reset** button:

- driving time
- distance
- average fuel mileage
- average speed

The trip computer only operates when the ignition is on. When you turn on the ignition, the function that was in use when you last turned the ignition off will be displayed.

Tips

- You can also set the values for the functions to zero in the menu display (**Reset**) ⇒ *page 22*.
- All stored values will be lost if the vehicle battery is disconnected. ■

Menu display

Introduction



Fig. 12 Wiper lever: Controls for the menu display



Fig. 13 Display: Start menu

Some functions in your vehicle can be set, activated, and controlled by **Menus**. With these menus you can also select the information shown in the driver information system, which operates only with the ignition switched on. Operation is controlled by the **Reset** button and the rocker switch on the wiper lever ⇒ *page 22*, *fig. 12*.

The **Start menu** shows you the different display types:

Set

Check

Menu off

Each display type in the Start menu contains a submenu with additional options.

Set	Clock	⇒ <i>page 25</i>
	Computer	⇒ <i>page 25</i>
	Speed alarm (speed warning)	⇒ <i>page 29</i>
	Language (6 languages)	⇒ <i>page 25</i>
	Units (distance, fuel consumption, temperature)	⇒ <i>page 25</i>
	Displays (gearshift recommendation)	⇒ <i>page 19</i>
	Lighting* (exterior lights, turn signals)	⇒ <i>page 57</i> ⇒ <i>page 59</i>
	Wiper (service position)	⇒ <i>page 68</i>
	Doors (unlocking and locking mode, for example Auto Lock)	⇒ <i>page 40</i> , ⇒ <i>page 41</i>
Check	Service	⇒ <i>page 27</i>
	Chassis number*	⇒ <i>page 294</i>
	Engine oil temperature*	
	Registered keys	⇒ <i>page 38</i>
Menu off	All of the messages shown in vehicles without menu display appear on the display screen.	

Navigating the menu

Use the rocker switch on the windshield wiper lever and the **Reset** button to operate the menu and carry out inquiries and selections.

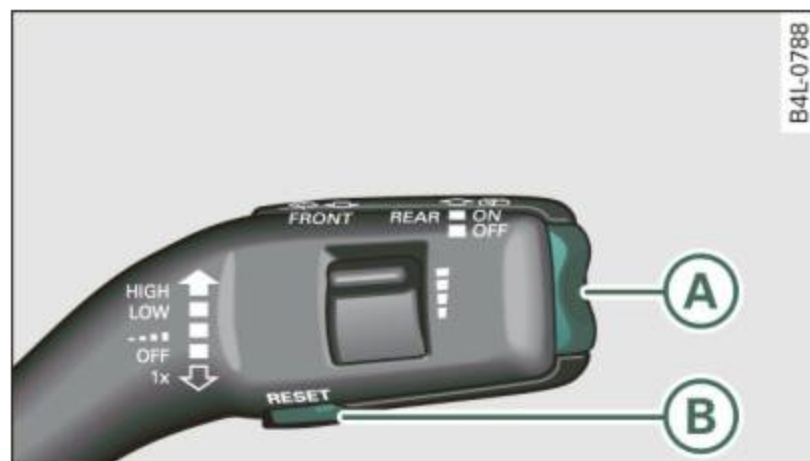

Fig. 14 Wiper lever: Controls for the menu display



Fig. 15 Display: Start menu

Reset button **B** and **rocker switch** **A** ⇒ fig. 14 functions:

To open the menu

- Press the **Reset** button **B** until the menu display ⇒ fig. 15 appears

Selections and settings

- Press the rocker switch **A** to reach a menu display. The switch is operated the same as the display (up/down).

Entering and confirming

- Press the **Reset** button **B**.

Returning to the Start menu

- Press the **Reset** button longer than 2 seconds to return from any menu level to the Start menu.

Using the rocker switch, you can select the menus in the display or change settings. A cursor appears on the left in front of the selected values.

By pressing the **Reset** button, you activate the selection you made or confirm the values you set. **Selected** functions are identified with a check mark or are carried out directly.

Meanings of the symbols in the display:

Selection bar	Selected function	Meaning
>	Cursor	Current Selection
✓	Check mark	Selected or Function active
☐	Box	Not selected
▲	Triangle pointing up	Previous page
▼	Triangle pointing down	Next page

Selecting settings

The Driver Information System settings are menu-guided.



Fig. 16 Display: Menu Settings, computer selected (page 1)

Select your settings as follows:

- Press the **Reset** button. The Start menu appears ⇒ page 23, fig. 13.
- Press the rocker switch until **Set** is displayed.
- Press the **Reset** button. All the menus appear.
- Press the rocker switch until the desired line is highlighted (cursor) ⇒ fig. 16.
- Press the **Reset** button.
- If necessary, scroll by selecting and activating the symbol for “Next page” or “Previous page”.

When you have selected the Computer menu and activated it by pressing the **Reset** button, two computer levels appear (computer 1 and computer 2). Now you have to select the level you want using the rocker switch and activate it with the **Reset** button. ■

Efficiency program

Applies to vehicles: with trip computer with efficiency program

Description



Fig. 17 Display: efficiency program

- Press the **RESET** button **B** ⇒ page 22, fig. 11 repeatedly until the efficiency program appears in the display.

The efficiency program can help you to use less fuel. It evaluates driving information in reference to fuel consumption and shows other equipment influencing consumption as well as shift recommendations. Fuel economy messages ⇒ page 26 provide tips for efficient driving.

The efficiency program uses distance and consumption data from trip computer 1. If the data are deleted in the efficiency program, those values are also reset in trip computer 1. ■

Applies to vehicles: with trip computer with efficiency program

Other equipment



Fig. 18 Display: other equipment

- In the efficiency program, press the function selection switch \Rightarrow page 22, fig. 11 (A) repeatedly until the other equipment appears in the display.

Other equipment that is currently affecting fuel consumption is listed in the efficiency program. The display shows up to three other items of equipment (B). The equipment using the most fuel is listed first. If more than three items using fuel are switched on, the equipment that is currently using the most fuel is displayed.

A scale (A) also shows the current total consumption of all other equipment. ■

Applies to vehicles: with trip computer with efficiency program

Fuel economy messages



Fig. 19 Display: fuel economy message

Fuel economy messages are displayed when fuel consumption is increased by certain conditions. If you follow these fuel economy messages, you can reduce your vehicle's consumption of fuel. The messages appear automatically and are only displayed in the efficiency program. The fuel economy messages turn off automatically after a certain period of time.

- To turn a fuel economy message off immediately after it appears, press the **RESET** button \Rightarrow page 22, fig. 11 (B), or
- Press the function selection switch \Rightarrow page 22, fig. 11 (A).

i Tips

- Once you have turned a fuel economy message off, it will only appear again after you turn the ignition on again.
- The fuel economy messages are not displayed in every instance, but rather in intervals over a period of time. ■

Service interval display

The service interval display reminds you when your next service is due.



Fig. 20 Section of instrument cluster: Service interval display

The schedule for the next oil change or inspection is calculated automatically and displayed accordingly. The display works in two stages:

Service reminder

30 days before the next service is due, a service reminder appears in the display when you turn on the ignition.

After about 5 seconds the display switches back to normal. The distance and time remaining are updated each time the ignition is turned on until the date due for service is reached.

Service due

When the due date for service is reached, the message **Service due !** appears in the instrument cluster immediately after you turn on the ignition. Additionally, a warning tone sounds. After about 5 seconds the display switches back to normal.

Calling up the service schedules

If or when an oil change or inspection is due, can be shown in the instrument cluster by selecting the service interval display. Select **Check > Service > Oil change** or **Service** by using the **RESET** button and the rocker switch ⇒ page 22, fig. 12.

Resetting the service interval display

Your authorized Audi dealer will reset the corresponding service schedule after performing the appropriate service on your vehicle. You also have the possibility to reset the oil change schedule after having performed an oil change according to Audi specifications.

- Switch the ignition on.
- Pull the knob ⑩ ⇒ page 8, fig. 2. The message **Service due!** appears.
- Pull the knob until the display **Oil change in ----- mi (km)--- days** appears in the display. If the reset button is not pulled within 5 seconds, the display reset mode closes.

! Note

If you disconnect the battery terminals, no calculations can be made for the service interval display during this time and no service reminder will appear. Remember that observing the proper service intervals is vitally important to extending the life of your vehicle, particularly the engine, and maintaining its value. Even if the mileage driven is low, the maximum period of one year from one service to the next must not be exceeded.

i Tips

- If a malfunction is present (red symbol), the distance remaining cannot be called up.
- Do not reset the display between service intervals. Doing so will result in an incorrect display.
- If the battery is disconnected, the Service Interval Display values are retained.
- On vehicles with the Driver Information System, you can also call up the service interval display ⇒ page 22.
- If service was not performed at the correct time or the service interval display was not reset after service was performed, the addi- ▶

tional mileage driven or the elapsed days will be shown as negative numbers. ■

Speed warning system

Overview

The speed warning system helps you to keep your driving speed below a set speed limit.



Fig. 21 Display: speed warning system

The speed warning system warns the driver if he exceeds a previously stored maximum speed. A warning tone will sound as soon as the vehicle speed exceeds the set speed by about 3 mph (3 km/h). At the same time, a warning symbol appears in the display ⇒ fig. 21.

The speed warning system has **two warning thresholds** that function independently of each other and that have somewhat different purposes:

Speed warning 1 / (Canada models)

You can use speed warning 1 to set the maximum speed while you are driving. This setting will remain in effect until you turn off the ignition, assuming that you have not changed or reset the setting.



The speed warning symbol  /  (Canada models) in the warning 1 display appears when you exceed the maximum speed. It goes out when the speed falls below the stored maximum speed.

The speed warning symbol will also go out if the speed *exceeds* the stored maximum speed by more than about 25 mph (40 km/h) for at least 10 seconds. The stored maximum speed is deleted.

Setting speed warning 1 ⇒ page 29.

Speed warning 2 / (Canada models)

Storing warning 2 is recommended if you *always* want to be reminded of a certain speed, for example when you are traveling in a country that has a general maximum speed limit, or if you do not want to exceed a specified speed for winter tires.

The speed warning 2 symbol,  /  (Canada models) appears in the display when you exceed the stored speed limit. Unlike warning 1, it will not go out until the vehicle speed drops below the stored speed limit.

Setting speed warning 2 ⇒ page 29.

Tips

Even though your vehicle is equipped with a speed warning system, you should still watch the speedometer to make sure you are not driving faster than the speed limit. ■

Speed warning 1: setting a speed limit

Warning threshold 1 is set by the button.





Fig. 22 Section of instrument cluster: Set/Check button

Storing the maximum speed

- Drive at the desired maximum speed.
- Press the knob button ⇒ fig. 22 until the ⇒ page 28, fig. 21 symbol appears.

Resetting the maximum speed

- Drive the vehicle at a speed of at least 3 mph (5 km/h)
- Press the knob for more than 2 seconds.

The speed warning symbol  (USA models)/ (Canada models) will appear briefly in the display when you release the button to indicate that the maximum speed has been stored successfully.

The maximum speed remains stored until it is changed by pressing the button again briefly or until it is deleted by a lengthy push on the button. ■

Speed warning 2: setting a speed limit

Switches in the wiper arm are used to operate warning threshold 2.

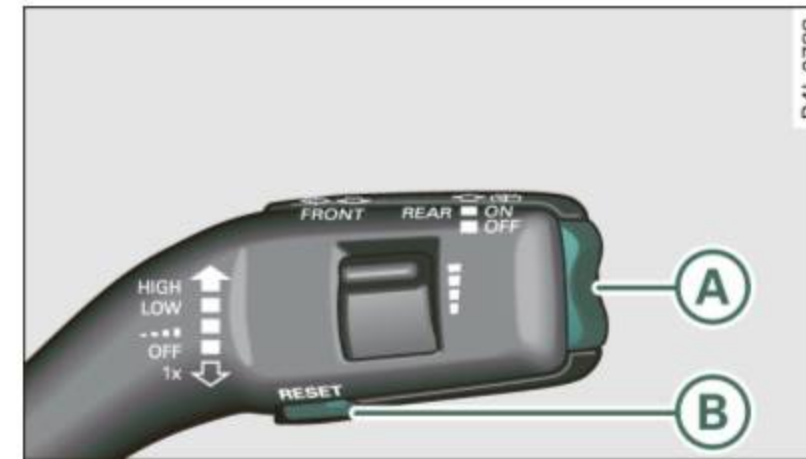

Fig. 23 Wiper lever: Trip computer controls

To store maximum speed

- Turn off the ignition.
- Briefly press the button in the instrument cluster ⇒ fig. 22. The odometer and the digital clock are now illuminated.
- Press the button for at least 2 seconds. The currently stored maximum speed appears in the display **or** the crossed out symbol for warning threshold 2, if no maximum speed was set previously.
- Press the function selector switch in the wiper lever **A** ⇒ fig. 23 up or down to change the set value. Values run up or down in steps of 6.2 mph (10 km/h).

To delete maximum speed

- Turn off the ignition.

- Briefly press the button in the instrument cluster ⇒ *page 29*, fig. 22. The odometer and the digital clock are now illuminated.
- Press the button for at least 2 seconds. The currently stored maximum speed appears in the display.
- Press the reset button in the wiper lever **B** ⇒ *page 29*, fig. 23 until the crossed out speed warning symbol for warning threshold 2 appears in the display.

A few seconds after the adjustment is completed, the illumination for the odometer and the digital clock will go out.

Tips



This warning threshold can also be controlled through the trip computer ⇒ *page 24*, “Navigating the menu”. ■

Warnings and symbols

Red symbols

A red symbol means DANGER

- Pull off the road and stop the vehicle.
- Turn off the engine.
- Check the malfunctioning system. Contact your authorized Audi dealer or a qualified workshop for assistance.

BRAKE	USA models: Malfunction in the brake system	⇒ <i>page 32</i>
	Canada models: Malfunction in the brake system	⇒ <i>page 32</i>
	Engine coolant level too low/ engine coolant temperature too high	⇒ <i>page 32</i>
	Engine oil pressure too low	⇒ <i>page 33</i>



When a red symbol appears, a warning tone will sound *three* times in succession. The symbol continues to flash until the malfunction has been repaired. If there is *more than one* malfunction, the symbols appear one after the other for about two seconds.

Tips

- The message for a malfunction can be shown by pressing on the left knob.
- During route guidance on vehicles with a navigation system, the warning symbol is shown in the field above. ■

Yellow symbols

A yellow symbol means WARNING.

	Clutch pedal	⇒ <i>page 33</i>
	Low fuel level	⇒ <i>page 34</i>
	Check engine oil level	⇒ <i>page 34</i>

	Engine oil sensor malfunction	⇒ page 35
	Engine speed limitation	⇒ page 34
	Diesel particulate filter	⇒ page 34
	Worn brake pads	⇒ page 35
	USA models: Speed warning 1	⇒ page 35
	Canada models: Speed warning 1	⇒ page 35
	USA models: Speed warning 2	⇒ page 35
	Canada models: Speed warning 2	⇒ page 35
	Dynamic headlight range control* defective	⇒ page 35
	Windshield washer fluid level low	⇒ page 35
	Battery voltage too high or too low	⇒ page 35
	Defective light bulb	⇒ page 36
	USA models: Defective brake light	⇒ page 36
	Canada models: Defective brake light	⇒ page 36
	Light/rain sensor defective (auto- matic headlights)* defective	⇒ page 36
	Tire pressure monitoring system*	⇒ page 36

When a yellow symbol appears, a warning tone will sound *once*. Check the displayed function as soon as possible. If *more than one* malfunction is detected, all symbols will appear one after the other for about two seconds. ■

Driver information

In addition to the warning/indicator lights and the symbols in the instrument cluster display, driver information is displayed.



Fig. 24 Section of instrument cluster: Set/Check button

Driver information appears in the display when a defective light bulb is reported by the defective light bulb warning ⇒ page 36, when the brake pads are worn and before you engage a gear on vehicles with S tronic.

In addition, driver information may appear when a red symbol flashes in the driver display.

To display Driver information

As an example, the  symbol appears in the display. If you now press the button ⇒ fig. 24 , the following driver message appears in the display:

Switch off engine and check oil level

The driver message in the display goes out after about 5 seconds. You can display the driver message again by briefly pressing the button. ■

Brake system malfunction **BRAKE** (USA models)/ (Canada models)

The indicator light flashes if the brake fluid level is too low, if there is a malfunction in the ABS system or when the parking brake is engaged.



If the **BRAKE**/ symbol flashes in the display with the parking brake released, there is a malfunction in the brake system. In addition to the symbol, one of two messages appears in the display:

Stop vehicle and check brake fluid

ABS fault ! See owner's manual

- Pull off the road and stop the vehicle.
- Obtain professional assistance.

USA models: if there is a malfunction in the ABS system, the **ABS** warning/indicator light illuminates along with the **BRAKE** system malfunction warning/indicator light ⇒ .

Canada models: if there is a malfunction in the ABS system, the  warning/indicator light illuminates together with the  brake system malfunction warning/indicator light ⇒ .

Parking brake set

The parking brake warning light **Brake**/ (Canada models) illuminates when the parking brake is set. In addition, a warning tone will sound after you have driven for longer than 3 seconds and faster than 3 mph (5 km/h).

WARNING

- Always observe the warnings in ⇒ *page 218*, “Engine compartment”, before opening the engine hood and checking the brake fluid.

WARNING (continued)

- Driving with low brake fluid is a safety hazard! Stop the car and get professional assistance.
- If the brake system warning/indicator light illuminates together with the ABS warning/indicator light, then the ABS system is malfunctioning. The rear wheels could quickly lock up when you apply the brakes. This could lead to loss of control and your vehicle could slide! Drive carefully to the nearest authorized Audi dealer and have the malfunction corrected. ■

Engine cooling system malfunction

A malfunction in the engine cooling system must be repaired as soon as possible.

When the  symbol in the display flashes, then either the engine coolant *temperature* is too high, or the coolant *level* is too low. In addition to the symbol, the following message also appears in the display:

Switch off engine and check coolant level

- Pull off the road and stop the vehicle.
- Turn off the engine.
- Check coolant level ⇒ *page 235*.
- Add coolant if necessary ⇒ *page 236*.
- Continue driving only after the engine coolant warning/indicator light goes out.
- Contact your authorized Audi dealer for assistance if necessary.

If the engine coolant level is correct, then the radiator fan may be the cause of the malfunction. ►

If the generator warning/indicator light should also illuminate ⇒ *page 15*, then the fan belt may be damaged.

WARNING

- If your vehicle should break down for mechanical or other reasons, park at a safe distance from moving traffic, turn off the engine and turn on the hazard warning lights ⇒ *page 59*, “Emergency flasher ”.
- Never open the hood if you see or hear steam or coolant escaping from the engine compartment - you risk being scalded. Wait until you can no longer see or hear steam or coolant escaping.
- The engine compartment of any vehicle is a dangerous area. Before you perform any work in the engine compartment, turn off the engine and allow it to cool. Follow the warning stickers ⇒ *page 218*, “Engine compartment”.

Note

Do not continue driving if the  symbol illuminates. There is a malfunction in the engine cooling system – you could damage your engine. ■

Engine oil pressure malfunction

The red engine oil pressure warning symbol requires immediate service or repair.

If the  symbol appears in the display and flashes, the oil pressure is too low. In addition to the symbol, the following message also appears in the display:

Switch off engine and check oil level

- Pull off the road and stop the vehicle.

- Shut the engine down.
- Check the engine oil level ⇒ *page 231*.
- Contact your authorized Audi dealer for assistance if necessary.

Engine oil level too low





If the engine oil level is too low, top off oil to the proper level ⇒ *page 232*.

Engine oil level OK

If the  symbol starts flashing again even though the engine oil level checks OK on the dipstick, **do not start driving again and do not let the engine run at idle**. Instead, contact your authorized Audi dealer for assistance.



Tips

- The engine oil pressure symbol  is not an indicator for a low engine oil level. Do not rely on it. Instead, check the oil level in your engine at regular intervals, preferably each time you refuel, and always before going on a long trip.
- The yellow oil level warning indication  requires oil refill or workshop service without delay. Do not wait until the red oil pressure warning symbol  starts to flash before you respond to the low oil level warning . By then, your engine may already have suffered serious damage. ■

Applies to vehicles: with manual transmission

Clutch pedal

The indicator light  illuminates if you do not press the clutch pedal when starting the engine. For safety reasons, the engine will only start when the clutch pedal is pressed. ■

Fuel supply too low

When the  symbol illuminates, this means there are about 2.6 gallons (10 liters) of fuel left in the fuel tank. Time to refuel!
⇒ *page 221*.

If the symbol lights up, even when there is ample fuel in the tank, and the text **Tank system malfunction! Please contact workshop** appears in the display, there is a fault in the system. Contact a qualified workshop to have the fault rectified. ■

Applies to vehicles: with engine speed limitation

Engine speed limitation

Engine speed maximum XXXX RPM



The  symbol illuminates when there is an engine control malfunction. The indicator light **EPC** in the instrument cluster also illuminates. The engine speed is limited to the speed displayed in the driver information system. Keep in mind that the engine speed will not exceed the value displayed in the driver information system, for example when downshifting.

Please go to an authorized Audi dealer or other qualified workshop to have the malfunction repaired. ■

Applies to vehicles: with diesel engine and diesel particulate filter

Diesel particulate filter clogged

Particulate filter ! See owner's manual

If the indicator light  in the instrument cluster comes on, the diesel particulate filter has become blocked with soot as the result of constant short-distance driving. When the  symbol illuminates, you can alter your driving style to assist the filter self-cleaning process. Drive for approximately 15 minutes in 4th or 5th gear (automatic transmission with the selector lever in the S position) at a

minimum speed of 37 mph (60 km/h) and an engine speed of approximately 2,000 RPM. The temperature increase that will result from this can burn off the soot in the filter. The symbol will switch off when the cleaning is successful. After a successful cleaning, there is no need to bring the car to an authorized dealer or qualified workshop because this is part of normal vehicle operation.

If the symbol  does not switch off, see your authorized dealer or other qualified workshop to have the problem corrected.

As long as the indicator light  remains on (diesel particulate filter plugged), you can expect increased fuel consumption and possibly also a loss of engine performance.

For more information on the diesel particulate filter, refer to
⇒ *page 199*.

WARNING

Always adapt your speed to the current weather, road and traffic conditions. You should never disobey traffic laws in order to follow driving recommendations. ■

Checking the engine oil level

Please add max. 1 qt of engine oil!

If the  symbol comes on, add 1 quart (1 liter) of oil at the next opportunity ⇒ *page 232*. ■

Checking the engine oil level

When the  symbol illuminates, check the engine oil level as soon as possible ⇒ *page 231*. Top off the oil at your earliest opportunity ⇒ *page 232*. ■

Engine oil sensor defective

If the  symbol illuminates, contact your authorized Audi dealer and have the oil sensor inspected. ■

Worn brake pads

Brake pads!

If the warning light illuminates, immediately contact your authorized Audi dealer or qualified workshop to have all brake pads inspected. On USA models the warning light  comes on together with the warning light **BRAKE**. Both sets of brake pads on an axle must always be replaced at the same time.

WARNING

Driving with bad brakes can cause a collision and serious personal injury.

- If the warning light  and the warning light **BRAKE**¹⁾ with the message Brake pads! comes on in the instrument cluster display, immediately contact your authorized Audi dealer or qualified workshop to have all brake pads checked or replaced if necessary. ■

Speed warning 1 (USA models)/ (Canada models)

If the  symbol illuminates, this means you are driving faster than the set vehicle speed. Slow down! ⇒ *page 28*. ■

Speed warning 2 (USA models)/ (Canada models)

If the  symbol illuminates, this means you have driven faster than the second set vehicle speed. Slow down! ⇒ *page 28*. ■

Applies to vehicles: with dynamic headlight range adjustment

Headlight range control defective

If the  illuminates, the dynamic headlight range control is no longer working properly. Have the system checked and repaired at your authorized Audi dealer. ■

Windshield washer fluid level too low

If the  symbol illuminates, add windshield washer fluid to the washer system ⇒ *page 243*. ■

Battery voltage low

If the  symbol illuminates, contact your authorized Audi dealer and have the following components inspected:

- drive belt
- battery charge

Also see if the generator warning/indicator light illuminates ⇒ *page 15*. ■

¹⁾ **BRAKE**: USA models only

Defective light bulb warning

The defective light bulb warning tells you when a vehicle light bulb has become defective.

If a defective bulb has been detected by the system or a light bulb burns out, the  symbol with a message appears in the display to tell you which bulb is burnt out and where it is located. For example:

Rear left turn signal

After 5 seconds, the message disappears. If you want to recall the message into the display, press the CHECK button ⇒ page 8, fig. 2 .

There are three reasons why the defective bulb message would appear in the display:

- The light bulb has burnt out ⇒ page 285.
- The fuse is “blown” ⇒ page 281, “Replacing fuses”.
- The wire connection to the light bulb is defective.

Have the bulb replaced or the connection repaired by your authorized Audi Service department.

WARNING

- Light bulbs are pressurized and could explode while they are being changed causing serious personal injury.
- Work with due care when handling the high-voltage section of gas discharge (xenon) lamps. Failing to do so could result in death or serious injury! ■

Brake light defective **BRAKE LIGHT** (USA models)/ (Canada models)

In case of a malfunction or component failure, the symbol **BRAKE LIGHT** (USA models)/ (Canada models) can appear. The following elec-

trical components should be checked, repaired or replaced, as necessary:

- Brake light bulbs
- All wiring connections
- Brake light switch

Contact your authorized Audi dealer for assistance if necessary.

Tips

The brake light switch is only inspected as part of the functional check after the engine is started. ■

Applies to vehicles: with automatic headlights

Light/rain sensor defective

The indicator light indicates a defect in the automatic headlights/automatic wiper system.

If the symbol illuminates, the light sensor has failed. For safety reasons, the low beams are turned on permanently with the switch in **AUTO**. However, you can continue to turn the lights on and off using the light switch. In the case of a defect in the rain sensor, the windshield wiper lever functions are still available. Have the light/rain sensor checked as soon as possible at an authorized Audi dealer. ■

Applies to vehicles: with tire pressure monitoring system

Tire pressure monitoring system

Tire pressure that is too low must be corrected as soon as possible.

If the  symbol flashes for about one minute after the ignition is switched on and then remains on, there is a malfunction in the system. Consult the nearest authorized Audi dealer as soon as possible. ►

Additional information about the **tire pressure monitoring system** can be found: ⇒ *page 264*. ■

Opening and closing

Keys

Key set

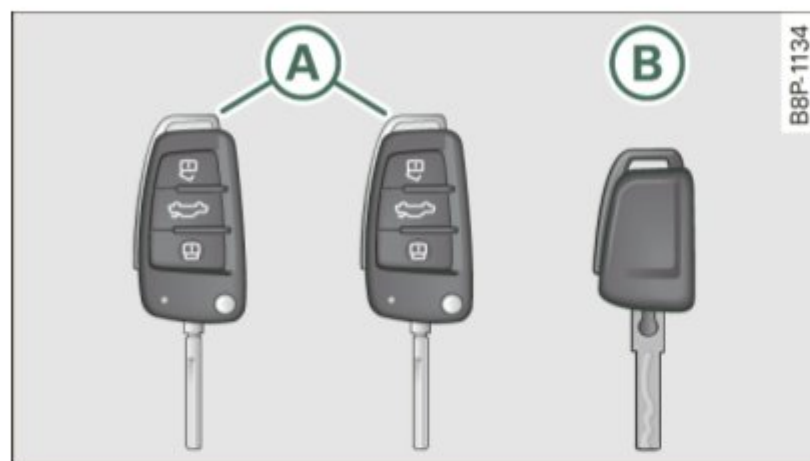



Fig. 25 Key set

The key set for your vehicle includes:

- Ⓐ two master keys (press the release button ⇒ *page 39*, *fig. 26* to fold and unfold the master key)
- Ⓑ one valet key

Ⓐ Master key with remote control

You can centrally lock and unlock your vehicle and start the engine with the master key with remote control. The rear lid can be unlocked with the remote control unlock button  on the master key.

Ⓑ Valet key

The valet key fits only the driver's door and the ignition lock. If you have to leave the key with somebody else, you are well-advised to turn over the valet key only.

Be aware that the rear lid can be opened from inside the vehicle with the remote rear lid release  located in the driver's door.

Key replacement

If you lose a key, contact your authorized Audi dealer immediately to have the *lost* key disabled. Be sure to bring all your keys with you.

Registered keys

You can check to find out how many remote keys have been registered to your vehicle. Therefore, when buying a used vehicle, make sure to get all of the remote keys that belong to it.

Calling up the registered remote keys ⇒ *page 22*.

An example of a possible display: **3/2**. The first digit indicates how many keys have been coded for your vehicle. The second digit indicates the current number of remote keys that are registered. For our example, this would mean that **2** keys have been enabled for your vehicle, and that, for example, one key has been lost.

If one key has been lost, contact an authorized Audi dealership to have the function locked for *this* key. Also inform your insurance company that this key is lost.

WARNING

- Do not leave your vehicle unattended with the key in the ignition lock. Entry by unauthorized persons could endanger you or result in theft or damage the vehicle. Always lock all doors and take the key.
- Do not leave children unattended in the vehicle, especially with access to vehicle keys. Unguarded access to the keys provides children the opportunity to start the engine and/or activate vehicle systems such as the power windows. Unsupervised operation of any vehicle system by children can result in serious injury.

Tips

- If you open the driver's door with the key left in the ignition lock, a chime will sound. This is your reminder to remove the key and lock the door.
- For security reasons, replacement keys are only available from authorized Audi dealers. ■

Master key with remote control

The remote control allows you to lock or unlock the vehicle electronically.



Fig. 26 Fold-up master key with remote control

- To fold the key out and back in place, press the release button ⇒ fig. 26.

The transmitter and battery are located in the head of the remote control. The receiver is located inside the vehicle. The maximum effective range depends on several things. Remember, if the battery is weak, the effective range decreases.

If you need to replace the remote control, or if you need to have it repaired, you must see your authorized Audi dealer. Only then can you use the key again.

Tips

- If the ignition is switched on, the remote control system is deactivated.
- The remote control system can be affected by other systems operating in the same frequency range close to the vehicle, such as mobile telephones, television broadcasting stations, etc.
- For Declaration of Compliance to United States FCC and Industry Canada regulations ⇒ page 303. ■

Check light in remote master key

The check light in the remote master key indicates the state of charge of the battery.



Fig. 27 Check light in the master key

State of master key battery

When a button is pressed, the check light flashes ⇒ fig. 27 (arrow). If the check light does not come on or flash, the battery is dead and has to be replaced.

Battery replacement ⇒ page 40. ■

Master key battery replacement

Each master key contains a battery housed under the cover.

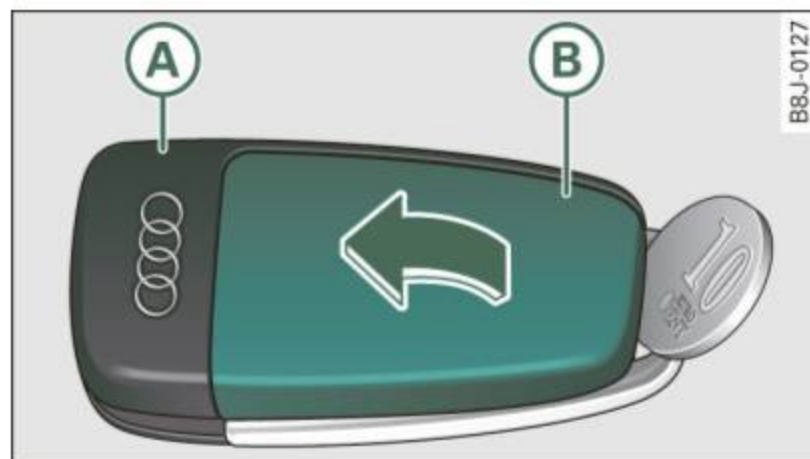

Fig. 28 Master key: opening the cover

We recommend having the battery changed by a qualified workshop. However, if you wish to replace the dead battery yourself, proceed as follows:

- Pry apart the base ⇒ fig. 28 **A** and the cover **B** **carefully** with a coin.
- Remove the cover (arrow).
- Remove the dead battery from the cover.
- Install the new battery. Please make certain that the “+” sign on the battery faces down in the cover. Correct polarity is shown on the cover.
- Place the cover with the new battery on the key base and press both parts together.



For the sake of the environment

Dispose of dead batteries properly so as not to pollute the environment.

i Tips

The replacement battery must be the same specification as the original. ■

Electronic immobilizer

The immobilizer helps to prevent unauthorized use of your vehicle.

A computer chip inside your key automatically deactivates the electronic immobilizer when you insert the key in the ignition lock. When you remove the key from the ignition lock, the electronic immobilizer is automatically activated once again.

i Tips

- The vehicle cannot be started if an unauthorized key is used. The vehicle may not start if another radio device such as a key for another vehicle or transponder is located on the key ring.
- For Declaration of Compliance to United States FCC and Industry Canada regulations ⇒ *page 303*. ■

Power locking system

General description

The power locking system locks or unlocks all doors and the rear lid simultaneously.

The power locking system in your vehicle incorporates the following functions:

- Central locking function
- Remote control feature ⇒ *page 39*.
- Anti-theft alarm system ⇒ *page 48*.



All the doors and the rear lid are locked by the central locking system when you lock the vehicle.

The unlocking and locking mode* can be changed in the driver information system ⇒ *page 22*.

Unlocking the vehicle

You can unlock the vehicle from outside either by using the remote control **or** by inserting and turning the key in the driver's door lock. When you **unlock** your vehicle:

- The anti-theft alarm system is deactivated briefly.
- The vehicle interior lights illuminate for approximately 30 seconds.
- All turn signal lights will flash twice when the car is unlocked.
- After unlocking the vehicle, you have 30 seconds to open a door or the rear lid. After 30 seconds, the vehicle automatically locks and the anti-theft alarm system activates again.

The rear lid can be locked or unlocked either by using the remote control **or** by inserting and turning the key in the driver's door lock. Unlocking the vehicle with the remote control  will only *unlock* the rear lid, to *open* it, the lid handle needs to be pressed.

Locking the vehicle

You can lock the vehicle from outside either by using the remote control **or** by inserting and turning the key in the driver's door lock. When you **lock** the vehicle:

- All doors and the rear lid are locked.
- All turn signal lights will flash once when the car is locked.
- The anti-theft alarm system is activated. The horn of the anti-theft alarm system will sound and the anti-theft alarm system readiness light, located in the center of the instrument panel below the windshield on the right side of the air vent, will start to blink.
- The vehicle interior lights turn off.

Automatic locking*

The automatic locking feature locks all the vehicle doors and the rear lid when you drive faster than 9 mph (15 km/h).

You can unlock the vehicle from the inside by:

- removing the key from the ignition switch (the vehicle will automatically unlock itself) or
- pressing the unlock part of the power lock switch  or
- pulling the inside handle for that door (once - the front door is unlocked and opened at the same time, twice to open the rear door).

If you wish, you can have an authorized Audi dealer convert your power door lock system to automatic locking.



WARNING

- **When you lock your vehicle from outside, nobody - especially children - should remain inside the vehicle. Remember, when you lock the vehicle from the outside the windows cannot be opened from the inside.**
- **When you leave the vehicle, always remove the ignition key and take it with you. This will prevent passengers (children, for example) from accidentally being locked in the vehicle should they accidentally press the power locking switch on the center console.**
- **Do not leave children inside the vehicle unsupervised. In an emergency it would be impossible to open the doors from the outside without the key.**



Tips

- In the event of a crash with airbag deployment all locked doors will be automatically unlocked to give access to the vehicle occupants from the outside.
- If the power locking system should fail, you can still open the fuel tank flap in an emergency ⇒ *page 224*.

- You are well advised not to keep valuables inside an unattended vehicle, visible or not. Even a properly locked vehicle cannot provide the security of a safe! ■

Unlocking and locking the vehicle with the remote control

How the remote control works.

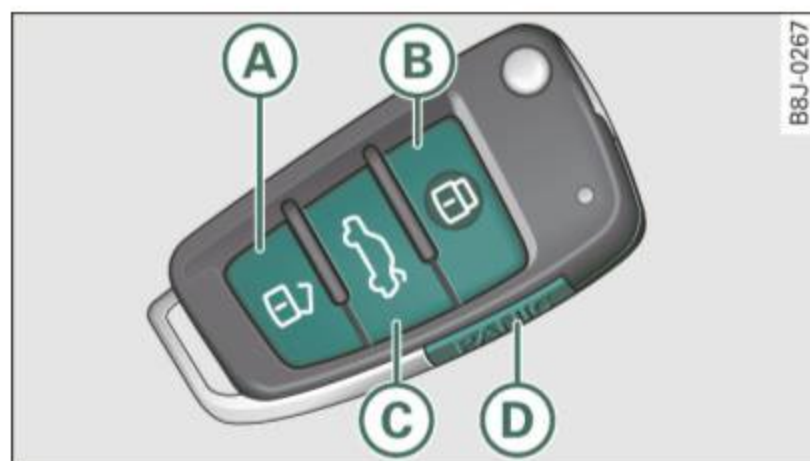

Fig. 29 Remote control: function buttons

To unlock the vehicle doors and rear lid

- Press button **A** once to unlock driver' door.
- Press button **A** twice to unlock all doors and the rear lid.

To lock the vehicle doors and rear lid

- Press button **B** ⇒  in "General description" on page 40.
- Watch that all turn signal lights flash once.

To open rear lid only

- Press button **C** for approximately one second.

PANIC Button

- Push the red button **D** to activate the panic function. The horn sounds and the turn signals flash.
- Push the button **D** again to deactivate the panic function.

The remote controls allows you to:

- lock or unlock the vehicle
- selectively unlock the rear lid.

The turn signals will flash briefly whenever you lock or unlock the vehicle. Also, the interior light will come on or go off whenever you open or close the driver's door.

The transmitter and battery are located in the head of the remote control. The receiver is located inside the vehicle. The maximum effective range depends on several things. Remember, if the battery is weak, the effective range decreases.

The remote-control key contains a fold-out key that you can use to manually lock or unlock the vehicle and to start the engine.

If you need to replace the remote control, or if you need to have it repaired, you must see your authorized Audi dealer. Only then can you use the key again.

WARNING

Read and follow all WARNINGS ⇒  in "General description" on page 40.



Tips

- The remote control key is automatically deactivated when the ignition is switched on.
- The operation of the remote control key can be temporarily disrupted by interference from transmitters in the vicinity of the vehicle working in the same frequency range (e.g. a cell phone, radio equipment).

- In order to make sure the locking function is working, you should always keep your eye on the vehicle to make sure it is properly locked.
- Do not use the remote control if you are inside the car, otherwise you may unintentionally lock the vehicle, and then you would set off the anti-theft alarm when you try open a door. In case this happens anyhow, push the unlock button .
- Use the panic function only if you are in an emergency situation. ■

Resetting the remote control

The remote control must be reset if the vehicle does not unlock.

- Press the unlock button  on the remote control.
- Manually unlock the driver's door lock with the mechanical key within 30 seconds.
- Press either the lock-  or the unlock  button to complete the reset sequence. ■

Doors, power locks

Operating the locks with the fold-out key

To lock and unlock the vehicle from the outside, turn the key in the lock of the driver's door.

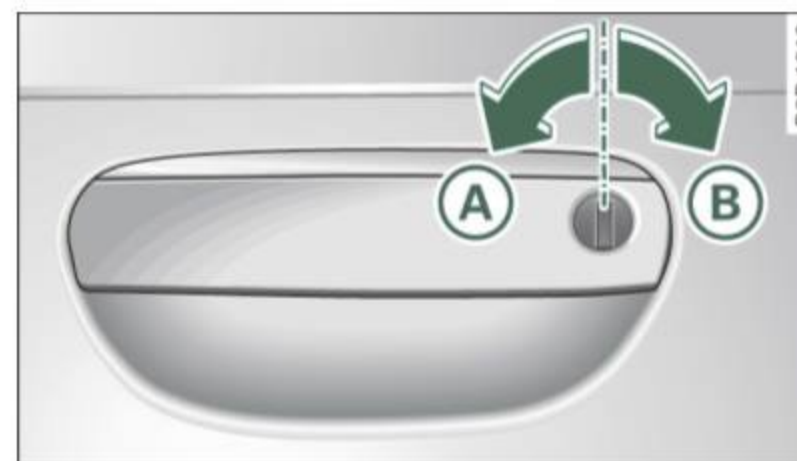



Fig. 30 Key turns for opening and closing.

To unlock all doors and the rear lid

- Turn the key to position  ⇒ fig. 30 to unlock the vehicle

To lock the vehicle

- Close all windows and doors properly.
- Turn the key in the lock of the driver's door to the lock position  ⇒  in "General description" on page 40.

When you **unlock** your vehicle:

- The anti-theft alarm system is deactivated.
- The vehicle interior lights illuminate for approximately 30 seconds.

When you **lock** the vehicle:

- All doors and the rear lid are locked.
- The anti-theft alarm system is activated.
- The vehicle interior lights turn off.

WARNING

Always read and heed WARNING ⇒  in “General description” on page 40. ■

Locking and unlocking the vehicle from inside



The vehicle can be locked or unlocked from the inside using the power locking switches located in the driver's and the front passenger's door.



Fig. 31 Driver's door: power locking switch

In addition to the central locking switches in the doors, there is a locking switch on the rear center console for the rear-seat passengers ⇒ page 45.

How to lock all doors and the rear lid simultaneously

- Press lower part of the power locking switch  ⇒ fig. 31 ⇒ .

How to unlock all doors and the rear lid simultaneously

- Press the upper part of the switch .

How to unlock / open each front door separately using the door handle

- Pull the door handle *once* to release the lock and simultaneously open the door.

How to unlock / open each rear door separately using the door handle

- Pull the door handle *once* to release the lock.
- Pull the handle *twice* to open the door.

If you lock the vehicle using the **power locking switch** , please note the following:

- You cannot open the doors or the rear lid from the *outside* (increased security, for example when you are stopped at a red light).
- The diode in the power locking switch illuminate when all the doors and the rear lid are closed and locked.
- You can unlock and open the doors individually from the inside by pulling once on the door handle for the front doors and twice for the rear doors.
- If the driver's door is opened (after you have locked the vehicle from the inside using the power locking switch), the door will remain unlocked to prevent you from locking yourself out of your vehicle. After you close the door, you have to lock the driver's door again.
- If you have a crash and the airbag is activated, the doors automatically unlock.

WARNING

- If you use the power locking switch with the doors closed, remember that all the vehicle doors will lock.
- Locking doors from the inside can help prevent inadvertent door opening during an accident and can also prevent unwanted entry from the outside. Locked doors can, however, delay assis-

⚠ WARNING (continued)

tance to vehicle occupants and hold up rescue efforts from the outside in an accident or other emergency.

i Tips



If the vehicle has been locked manually with the key or with the remote control, the central locking switch is inoperative. ■

Rear power locking switch

There is also a power locking switch in the rear center console for passengers sitting in the rear.



Fig. 32 Rear power locking switch

- Press switch  ⇒ fig. 32 to lock the vehicle ⇒  in “Locking and unlocking the vehicle from inside” on page 44.

This switch does not unlock the doors.

See also ⇒ page 44, “Locking and unlocking the vehicle from inside”. ■

Rear lid

The rear lid is opened by the power locking system using the  button.

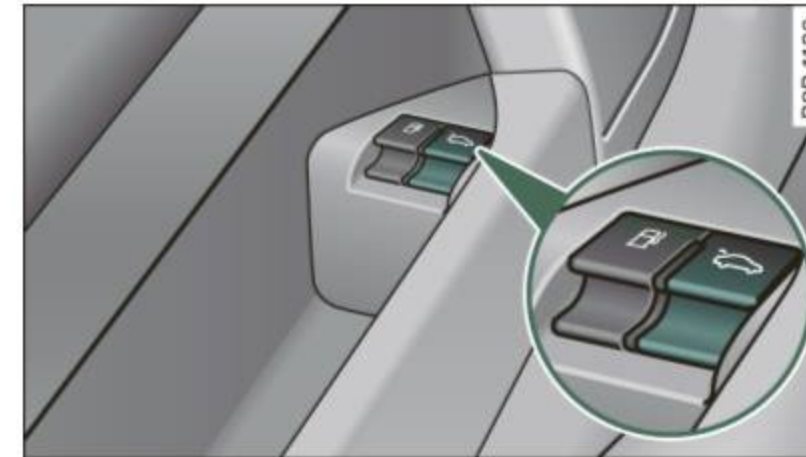





Fig. 33 Driver's door, rear bottom: remote rear lid release



Fig. 34 Handle location in the rear lid

Opening the rear lid

- Pull the switch  ⇒ fig. 33 in the driver's door.
- *Unlock* the rear lid by pressing the  button on the remote control ⇒ fig. 33.
- Lift the lid ⇒ fig. 34. 

Closing the rear lid

- Pull it down and shut it firmly ⇒ . There is a recess in the interior trim of the lid to make it easier to pull down.

WARNING

- After closing the rear lid, always pull up on it to make sure that it is properly closed. Otherwise it could open suddenly when the vehicle is moving.
- To help prevent poisonous exhaust gas from being drawn into the vehicle, always keep the rear lid closed while driving. Never transport objects larger than those fitting completely into the luggage area, because then the rear lid cannot be fully closed.
- Never leave your vehicle unattended especially with the rear lid left open. A child could crawl into the car through the luggage compartment and pull the lid shut, becoming trapped and unable to get out. To reduce the risk of personal injury, never let children play in or around your vehicle. Always keep the rear lid, as well as the vehicle doors, closed when not in use.

Tips

- If the rear lid is open or not properly locked when the ignition is turned on, the door and rear lid warning appears in the instrument cluster display.
- If the rear lid on a locked vehicle is unlocked with the middle button  on the remote key, the rear lid is automatically locked again immediately after closing. This is indicated by the turn signals blinking. ■

Emergency release for rear lid

If the rear lid cannot be opened, an emergency release is provided.

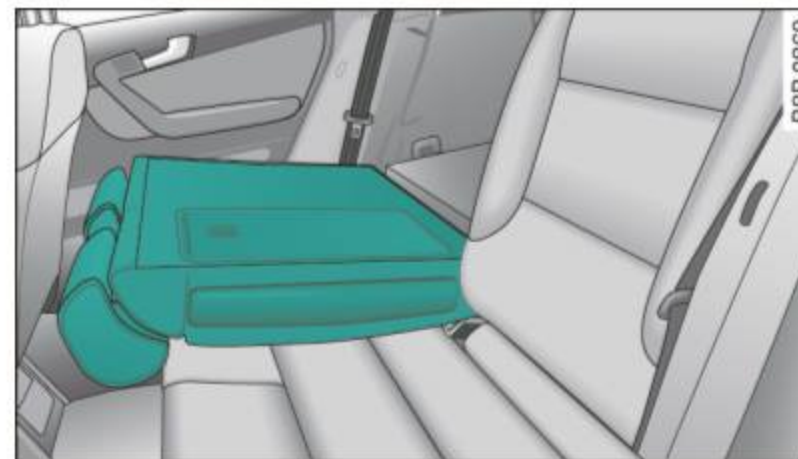



Fig. 35 Rear and trunk section: Access to emergency release



Fig. 36 Rear lid interior section: Emergency release

The emergency release is located on the inside of the rear lid. To release the rear lid, proceed as follows:

- Fold down the right rear seatback ⇒ fig. 35.
- Take your ignition key and move through the opening until your head and shoulders are in the trunk.
- Now insert the key bit into the slot in the cover as shown in ⇒ fig. 36  and pry the cover up carefully. ►

- Place the key in the round opening behind the cover ② and turn the key in the direction of the arrow. This unlocks the lock and the rear lid opens a crack.
- Open the rear lid from the outside and put the ignition key in a safe place. ■

Manual door locking

If the power locking system fails (power failure), you will need to lock the passenger door separately.



Fig. 37 Emergency locking device in the doors

An emergency door locking device is integrated in the rear edge of the doors (only visible when the door is open) for those doors without a lock cylinder.

- Open the door.
- Remove the plastic cap using the vehicle key ⇒ fig. 37.
- Stick the key into the internal slot and turn the key about 90 degrees as far as it can go to the right (right-side doors) or to the left (left-side doors).
- Replace the plastic cap.

After you close the door, you will no longer be able to open it from the outside.

You can open it from the inside, however, by pulling on the door latch, *once* for the front doors and *twice* for the rear doors. ■

Child safety lock

The child safety lock prevents the rear doors from being opened from the inside.



Fig. 38 Rear doors: child safety lock

The rear doors are equipped with a child safety lock. It is operated with the vehicle key. The child safety lock is only visible when the door is open.

- To **switch on** the child safety lock, turn the ignition key in the direction of the arrow.
- To **switch off** the child safety lock, turn the ignition key in the opposite direction of the arrow.

The child safety lock prevents the doors from being opened from the inside when you have small children sitting in the rear. ■

Anti-theft alarm system

The anti-theft alarm triggers an alarm if anyone attempts to break into the vehicle.

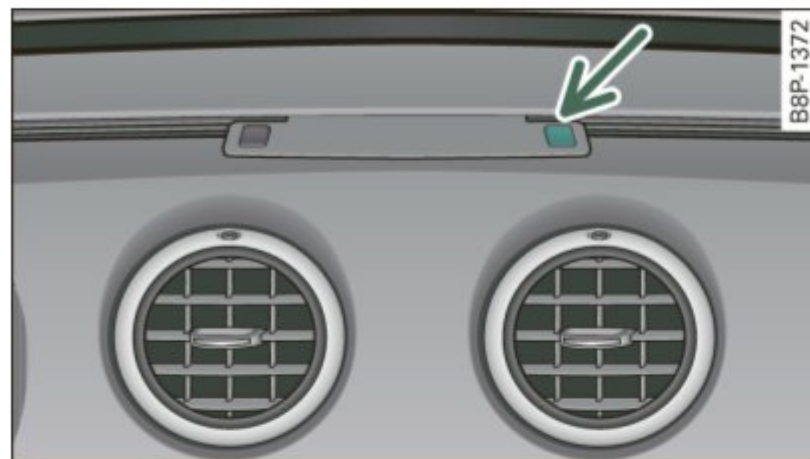

Fig. 39 Diode position in the instrument panel

The anti-theft alarm system triggers an audible alarm and turns on the emergency flasher if an unauthorized interference with the vehicle is sensed by the system.

How is the anti-theft alarm system switched on?

The anti-theft alarm system is switched on when you lock the driver's door manually using the fold-out key, or when you use the remote control. The system is activated approximately 30 seconds after the vehicle is locked. The indicator light ⇒ fig. 39 starts flashing rapidly for 30 seconds and then blinks slowly.

How is the anti-theft alarm system switched off?

The anti-theft alarm system is switched off when you use the remote control to unlock your vehicle. If you do not open a door within 30 seconds after you have unlocked with the remote control, the vehicle will lock itself again automatically.

If you lock just the driver's door using your key, the front passenger's door and the rear lid remain locked.

When will the anti theft alarm system be triggered?

When the vehicle is locked, the alarm system monitors and protects the following parts of the vehicle:

- engine compartment
- luggage compartment
- doors
- ignition

When the system is activated, the alarm will be triggered if one of the doors, the engine hood or the rear lid are opened, or if the ignition is turned on or the radio removed.

The anti-theft alarm system will also go off when the battery is disconnected.

You can also trigger the alarm by pressing the PANIC button on your remote-control key. This will alert other people in case of emergency. Press the **PANIC** button again to turn off the alarm.

How is the anti-theft alarm switched off when triggered?

The alarm system is switched off when you unlock the vehicle using the remote-control key or when the ignition is switched on. The alarm will also switch itself off when it comes to the end of its cycle.

Emergency flasher

The emergency flasher will blink briefly when the doors, engine hood and rear lid are properly closed.

If the emergency flashers do not blink, check the doors, engine hood and rear lid to make sure they are properly closed. If you close a door, the hood or the rear lid with the anti-theft alarm switched on, the emergency flashers will blink only after you have closed the door or lid.

Tips

For the anti-theft alarm system to function properly, make sure all vehicle doors and windows are closed before leaving the vehicle. ■

Power windows

Controls

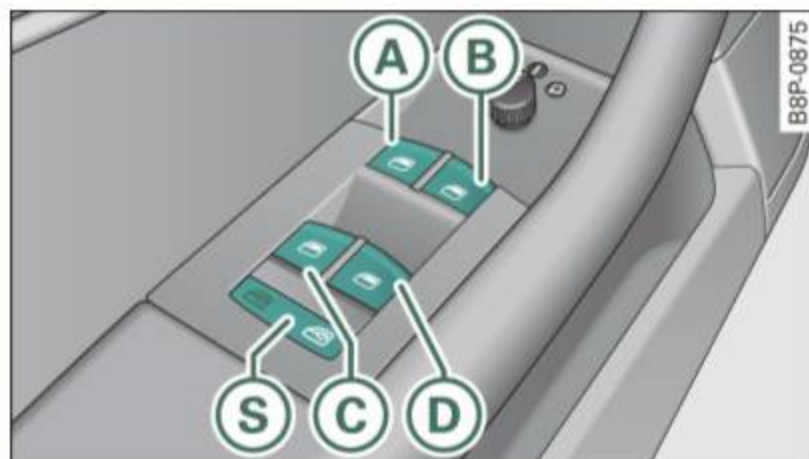

Fig. 40 Driver's door: power window switches

The switches are located in the driver's door. The front passenger's door has a own power window switch of its own.

To open/close If the respective switch is pushed or pulled, the window will , respectively.

Switches for front door windows

- (A) operates the window in the driver's door.
- (B) operates the window in the front passenger's door.

Switches for rear windows

- (C) operates the left rear window.
- (D) operates the right rear window.

Safety switch

- (S) Safety switch for rear window operation.

WARNING

- Do not leave children unattended in the vehicle, especially with access to vehicle keys. Unsupervised use of the keys can result in

WARNING (continued)

starting of the engine and use of vehicle systems such as power windows, etc. which could result in serious injury.

- Remember – you can still open or close the power windows for about ten minutes after the ignition is switched off. Only when either of the front doors are opened are the power windows switched off.
- Be careful when closing the windows. Check to see that no one is in the way, or serious injury could result!
- Always remove the ignition key whenever you leave your vehicle.
- If you lock your vehicle from the outside, no one, especially children, should remain in the vehicle.
- Do not stick anything on the windows or the windshield that may interfere with the driver's field of vision. ■

Switches in the driver's door

The driver can operate all windows.

In addition to the switches in the driver's door, there is a separate switch in each door for the power window in that door ⇒ fig. 40. If the respective switch is pushed or pulled, the window will open or close. The power window switches have a **two-position function**:

Opening the windows

- Push the switch to the **first stop** and hold it there until the window has lowered to the desired position.
- Push the switch briefly to the **second stop**: the window will automatically open all the way. ►

- By briefly pressing/pulling the switch again, the downward travel of the window can be stopped in any position ⇒ ⚠ in “Controls”.

Closing the windows

- Pull the switch up to the **first stop** and hold it there until the window has risen to the desired position.
- Pull the switch quickly to the **second position**: the window will automatically close all the way ⇒ ⚠ in “Controls”.
- By briefly pressing/pulling the switch again, the upward travel of the window can be stopped in any position ⇒ ⚠ in “Controls”.

Activating/deactivating rear windows

- Push the switch to the *depressed* position to **activate** the rear windows - the light in the switch will go out.
- Briefly press the switch to **deactivate** the rear windows - the switch will return to the safety position and the light 📡 will illuminate.

The safety switch (S) ⇒ page 49, fig. 40 in the armrest on the driver's door turns off the rear power windows. Only when the safety switch is depressed can the rear windows be opened or closed. The symbol in the safety switch illuminates when the power windows in the rear doors are switched off (button NOT depressed). This feature has been provided for the safety of small children riding in the rear of the vehicle.

Tips

The windows can still be opened and closed for about ten minutes after the ignition has been turned off. The power windows are not shut off until one of the front doors is opened. ■

Convenience close/open feature

You can close or open the windows from outside when you lock or unlock your car with the key.

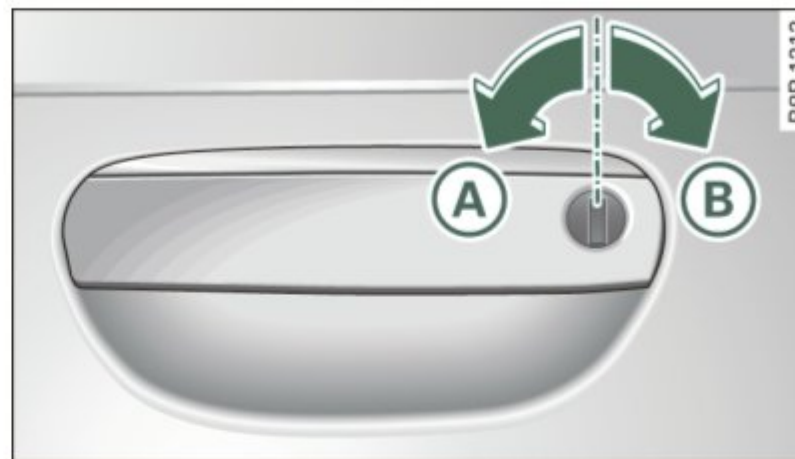

Fig. 41 Key turns for opening and closing

Convenience open feature

- Keep the key in the lock on the driver's door (A) until all windows and the panorama sliding/tilt roof* have reached the desired position.

Convenience close feature

- Hold the key in the lock of the driver's door in the closed position until all windows and the panorama sliding/tilt roof* are closed ⇒ ⚠.

The automatic close function will cease **immediately** if the key is released. For safety reasons it is not possible to open and close the sunroof with the remote-control key.

WARNING

- Be careful when closing the windows. Check to see that no one is in the way, or serious injury could result!
- Always read and heed WARNING ⇒ ⚠ in “General description” on page 40. ■

Reactivating the system after battery disconnection

Reactivating the convenience close/open feature

If the vehicle battery is disconnected and then reconnected, the automatic closing and opening function will not work until it is reactivated. To reactivate this feature, perform the following steps:

Reactivating close/open feature

- Pull and hold the power window switch until the window is completely closed.
- Release the switch.
- Pull the switch again for one second. The automatic closing/opening is now reactivated. ■

Panoramic sliding sunroof

Applies to vehicles: with panoramic sliding sunroof

Description

The panoramic sliding sunroof is operated with the toggle switch ⇒ fig. 42 when the ignition is on.

The panoramic sliding sunroof can still be opened or closed for about 10 minutes after the ignition has been switched off. However, as soon as the driver's or passenger's door is opened, the switch for the roof is inoperative. ■

Applies to vehicles: with panoramic sliding sunroof

Opening and closing panoramic sliding sunroof

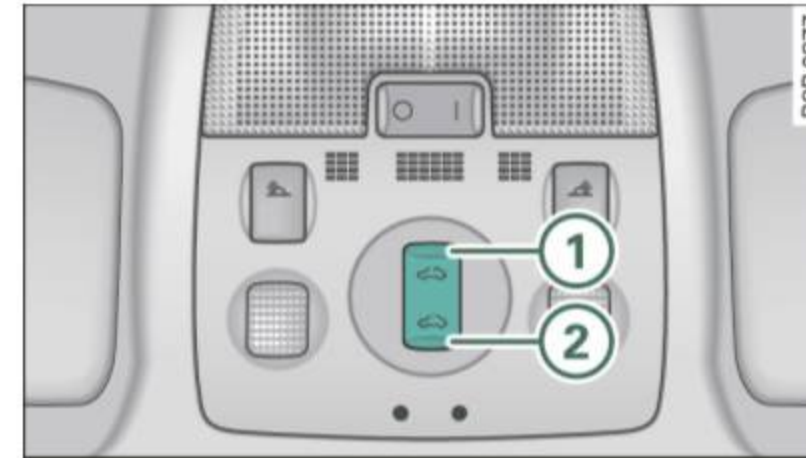

Fig. 42 Section of the roof liner Toggle switch for the panoramic sliding sunroof

The panoramic sliding sunroof is opened in two stages. First, the roof lifts up and then it can be opened.

Lifting

- Tap the switch ① ⇒ fig. 42 briefly, and the roof lifts automatically (pop-up position).

Opening automatically (independent operation)

- Tap the switch ① ⇒ fig. 42 briefly, and the roof moves to the **lift position**.
- Tap the switch ① briefly a second time, and the roof moves to the **low wind noise comfort position**.
- Press the switch ① until the roof is **fully** open. In this position increased wind noise may occur. ▶

Opening manually (manual operation)

- Press the switch ① ⇒ page 51, fig. 42, starting from the “lift position” until the roof has reached the desired position.

Closing completely

- Press the switch ② ⇒ page 51, fig. 42 until the roof is completely closed ⇒ ⚠.

Closing partially

- Press the switch ② ⇒ page 51, fig. 42 until the roof has reached the desired position ⇒ ⚠. If the roof is almost closed and you interrupt the operation, the roof opens automatically to a minimum setting; this is the smallest possible opening that can be set.

If you park your vehicle in the sun, we recommend that you close the sun blind. You should especially make certain that the panoramic sliding sunroof is closed when the sun blind is closed when parked or if there is a sudden rain shower.

The sun blind has two positions: completely open or completely closed. The sun blind is manually operated.

WARNING

Never close the panoramic sliding sunroof carelessly or without watching - there is a risk of personal injury. For this reason, always remove the ignition key when leaving the vehicle.

Tips

- When you park your vehicle, we generally recommend closing the panoramic sliding sunroof and the sun blind.

- When the vehicle is parked, a wet roof should be dried lightly with a soft cloth **before it is opened** so that water does not drip into the interior.
- In an emergency, the panoramic sliding sunroof can be closed manually ⇒ page 53, “Emergency mechanical closing for the panoramic sliding sunroof”. ■

Applies to vehicles: with panoramic sliding sunroof

Comfort closing

The open roof can also be closed from the outside.

- Hold the key in the driver's door lock in the lock position until the roof is closed ⇒ ⚠.

WARNING

Never close the panoramic sliding sunroof carelessly or without watching - there is a risk of personal injury. ■

Emergency mechanical closing for the panoramic sliding sunroof

Applies to vehicles: with panoramic sliding sunroof

Uncovering the light unit

In an emergency, the panoramic sliding sunroof can be closed manually. Removal of the light unit requires some dexterity.

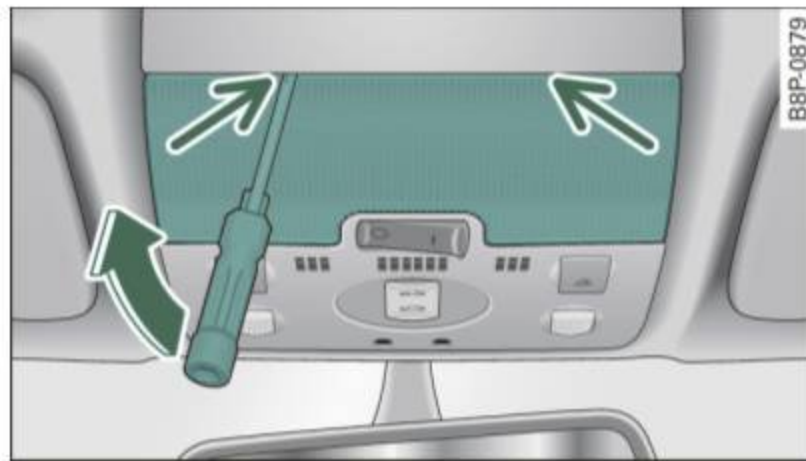

Fig. 43 Light unit in the headliner: removing the glass

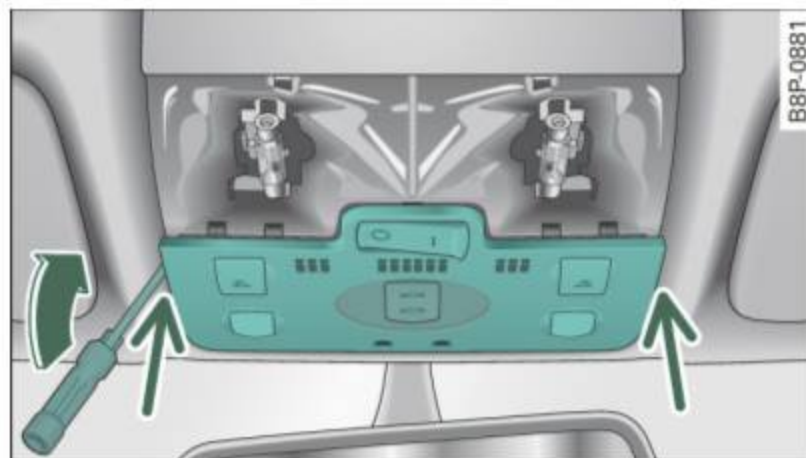

Fig. 44 Light unit in the headliner: removing the switch cover

Please switch off all lamps before removing the light unit ⇒ ⚠. The glass and the switch cover simply click into place for installation. Be sure they are positioned correctly for installation.

Removing the glass

- Take the screwdriver from the vehicle tool kit .
- Use the flat end of the reversible screwdriver blade.
- Insert the screwdriver carefully between the light unit and the glass into the visible marks (arrows) ⇒ fig. 43.
- Pry the glass out carefully.

Removing the switch cover

- Push the flat blade of the screwdriver several times in succession between the light unit and the switch cover at different places on the left and right and carefully lift the switch cover as you do this ⇒ fig. 44. On vehicles with additional equipment you can allow the cover to hang by the wire, otherwise place the loose cover to one side.

⚠ WARNING

Before working on the front light unit switch the integral lamps off - otherwise you risk being burned. ■

Applies to vehicles: with panoramic sliding sunroof

Removing the light unit

Removing the light unit requires some dexterity.



Fig. 45 Light unit in the headliner: removing screws in the light unit



Fig. 46 Removing the light unit

Installation of the light unit follows the steps used in removal, but in reverse order.

- Install the Phillips head blade in the screwdriver.
- Turn the two screws in the light unit in a counter-clockwise direction to remove ⇒ fig. 45.
- Pull the light unit out of the headliner by the front end (arrow) ⇒ fig. 46.
- Allow the light unit to hang by the wire. ■

Applies to vehicles: with panoramic sliding sunroof

Closing the open sky roof manually

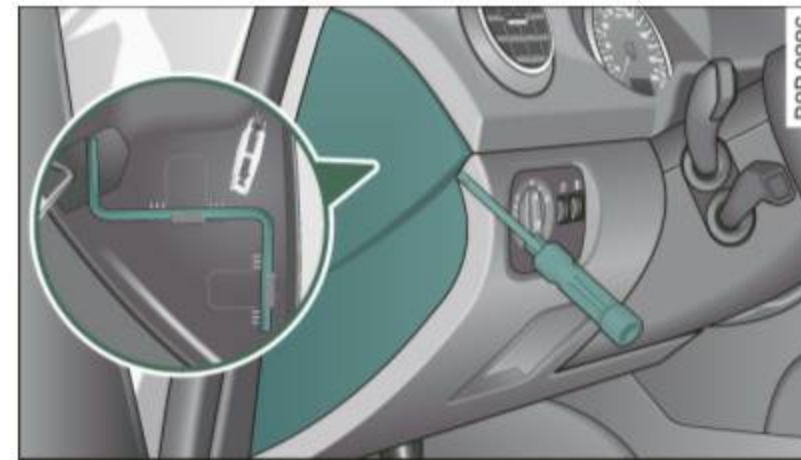

Fig. 47 Left end face of the instrument panel: fuse cover with hand crank

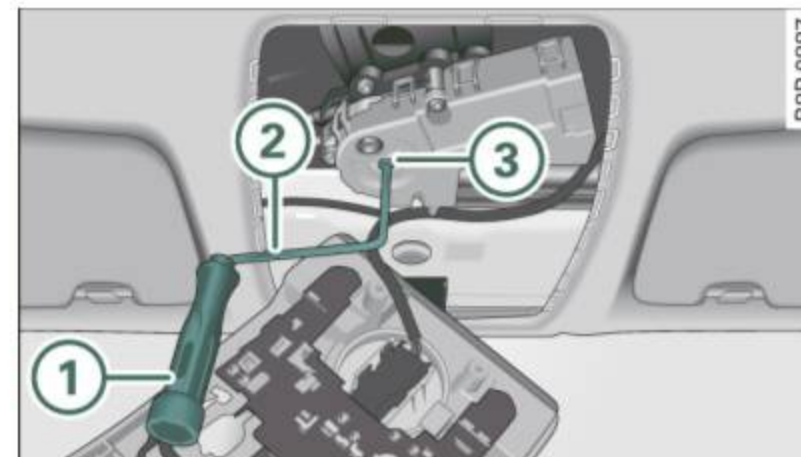

Fig. 48 Light unit in the headliner: crank for emergency operation

You can close the panoramic sliding sunroof using the hand crank located on the inside of the fuse box cover.

- Install the flat blade in the screwdriver.
- Use the screwdriver to remove the fuse box cover ⇒ fig. 47.
- Remove the crank from the fuse box cover.
- Remove the blade from the screwdriver handle.

- Install the end of the screwdriver handle onto the short side of the crank to help you turn it ⇒ *page 54*, fig. 47 ①.
- Push the long end of the crank ② ⇒ *page 54*, fig. 48 all the way into the hexagonal hole ③.
- Hold the crank down and turn it with the screwdriver handle to close the roof.
- Install the light unit first and then the glass. For installation, reverse the removal sequence.
- Return the crank to its location in the fuse box cover ⇒ *page 54*, fig. 47 and install the cover.
- Have the problem corrected.

Tips

- To turn the crank for emergency closing more easily, you should use the screwdriver handle as an aid. First, remove the screw driver from the handle, then push the handle onto the crank.
- The crank should be turned slowly; turning it quickly only increases the effort required. ■

Clear vision

Lights

Switching the headlights on and off



Fig. 49 Instrument panel: light switch



Fig. 50 Instrument panel: Light switch with daytime running lights (DRL)

The light switch must not be overturned past the stops in **either** direction.

Switching on automatic headlight control*

- Turn the light switch to **AUTO*** ⇒ fig. 49.

Switching on the side marker lights

- Turn the light switch to .

Switching on the headlights and high beam

- Turn the light switch to .
- Push the high beam lever forward towards the instrument panel ⇒ *page 59*.

Switching off the lights

- Turn the light switch to **0**.

The headlights only work when the ignition is switched on. While starting the engine or when switching off the ignition, the headlights will go off and only the side marker lights will be on.

Daytime running lights (DRL) (USA models)

The daytime running lights can be turned on or off using this function. If the function is active, the daytime running lights are turned on automatically when the ignition is switched on.

The daytime running lights are activated **only** when the light switch is at the **AUTO*** or **DRL*** position.

Daytime running lights (Canada models only)

The daytime running lights are activated **only** when the light switch ⇒ fig. 49 is either at the **0** or the  position.

The daytime running lights function cannot be turned off.

Automatic headlight control*

In the switch position **AUTO** the **automatic headlight control** is turned on. The low beams are turned on automatically through a light sensor as soon as ambient brightness (e.g. when driving into a tunnel) falls below a value preset at the factory. When ambient

brightness increases again, the low beams are turned off again automatically ⇒ .

In the **AUTO** position the low beams are switched off automatically when the ignition is turned off.

Light Sensor Malfunction*

In the event of a light sensor malfunction, the driver is notified in the instrument cluster display:

Automatic headlights/automatic wipers defective

For safety reasons the low beams are turned on permanently with the switch in **AUTO***. However, you can continue to turn the lights on and off using the light switch. Have the light sensor checked as soon as possible at a dealership.

Coming home/leaving home function*

The function is switched on when the switch is in the **AUTO*** position and the function is shown as active in the driver information system.

The **coming home** function illuminates the area around the vehicle when the ignition is switched off and the driver's door is opened. The length of time the lights remain on can be set in the menu display (**Illumination > Exterior lights > coming home**).

The **leaving home** function illuminates the area around the vehicle when unlocking it.

WARNING

- **Never use daytime running lights to see where you are going. They are not bright enough and will not let you see far enough ahead for safety, especially at dusk or when it is dark. Always switch on the low beams at dusk or when it is dark.**
- **Automatic headlights are only intended to assist the driver. They do not relieve the driver of his responsibility to check the headlights and to turn them on manually according to the current light and visibility conditions. For example, fog and rain cannot be**

WARNING (continued)

detected by the light sensors. So always switch on the headlights under these weather conditions and when driving in the dark .

- **Crashes can happen when you cannot see the road ahead and when you cannot be seen by other motorists.**
 - **Always turn on the headlights so that you can see ahead and so that others can see your car from the back.**

Tips

- With the switch in **AUTO** front fog lights cannot be turned on in addition.
- The light sensor for headlight control is located in the rear view mirror mount. Do not apply any stickers to the windshield in this area to prevent malfunctions or failures.
- Some exterior lighting functions can be adjusted in the driver information system ⇒ *page 22*.
- If you remove the ignition from the ignition lock while the headlights are still on, a buzzer will sound as long as the driver's door is open to remind you to turn off the lights.
- Always observe the specific local regulations for your area as to when to use your lights.
- With automatic headlights, the high-beam function is also available, but with one restriction: If you have not switched the high beams back to low beams during automatic headlight operation (for example, after driving through a tunnel), only the low beams come on the next time automatic headlights are switched on. To use the high beams, you first have to pull the high beam lever back and then push the lever forward again.
- In cool or damp weather, the inside of the headlights, turn signals and tail lights can fog over due to the temperature difference between the inside and outside. They will clear shortly after switching them on. This does not affect the service life of the lighting. 

- Frequent use of the coming home/leaving home function for approaching and departing a vehicle parked in the dark will strain the battery. This applies particularly if only short distances are driven between stops. Occasionally drive longer distances to make sure the battery is recharged sufficiently. ■

Front fog lights ☼

Use the light switch to turn on the front fog lights.



Fig. 51 Fog light activation: light switch position on vehicles WITHOUT sensor light

Switching on the front fog lights ☼

- Do **not** turn the light switch ☼ ⇒ fig. 51 toward the fog light symbol ☼.
- Turn the light switch to ☼ or to ☼.
- Pull the light switch to the *first* stop ①.

When the front fog lights are on, the symbol ☼ next to the light switch will illuminate. ■

Instrument panel illumination

The illumination of the instruments, displays and the center console can be adjusted.



Fig. 52 Instrument panel illumination

You regulate the brightness of the instruments with the left thumbwheel ☼ ⇒ fig. 52.

Ignition ON, light switch at 0.

With the ignition switched ON, the glow of *instrument needles* can be adjusted to appear brighter or dimmer.

Ignition ON, light switch at ☼ or ☼.

With the lights switched on, the brightness of instrument cluster (i.e. needles, gauges and displays) and center console illumination can be adjusted.

! Note

The instrument cluster and center console illumination (gauges and needles) comes on when you switch on the ignition and the **vehicle headlights are off**. Be aware of the following difference between models built to US or Canadian specifications:

- **USA models:** illumination of the instrument cluster (gauges and needles), dash and center console around the gearshift lever is controlled by a light sensor located in the instrument panel. The ►

instrument panel illumination will automatically become dimmer as the daylight fades away and eventually will go out completely when outside light is very low. This is to remind you, the driver, to switch on the headlights before it gets too dark.

- **Canada models:** instrument panel illumination will stay bright regardless of the intensity of ambient light. Always be aware of changes in outside light conditions while you are driving. Respond in time to fading daylight by turning the light switch to position  (or "AUTO" if your car is equipped with this feature) to turn on your headlights. ■



Emergency flasher

The emergency flasher makes other motorists aware that you or your vehicle are in an emergency situation.



Fig. 53 Center console: emergency flasher switch

- Press the switch  ⇒ fig. 53, to switch the emergency flasher on or off.

When the emergency flasher is on, all four turn signal blink at the same time. The turn signal indicator lights  in the instrument cluster, as well as the light in the emergency flasher switch  blink likewise.

The emergency flasher will automatically switch on if you are in an accident where the airbag has deployed.

Tips

You should switch on the emergency flasher when:

- you are the last vehicle standing in a traffic jam so that any other vehicles coming can see you, or when
- your vehicle has broken down or you are in an emergency situation, or when
- your vehicle is being towed by a tow truck or if you are towing another vehicle behind you. ■

Turn signals - and high beam lever



The lever on the left side of the steering column is used to operate the turn signals and the high beam as well as the headlight flasher.



Fig. 54 Turn signal and high beam lever

The turn signal and high beam lever has the following functions:

Turn signals

- Lift the lever up all the way ⇒ fig. 54 , to use the right turn signals, or push the lever down all the way  to use the left turn signals. ►

Auto-blink

- Move the lever (up or down) just to the point of resistance to use the turn signals for as long as you need them, for example when changing lanes.
- Briefly move the lever up or down just to the point of resistance and then release it to flash the turn signals *three times in succession*. This feature allows to indicate lane changes clearly and with minimum effort when driving on highways.





High beam

- Push the lever forward  to switch on the high beam.
- Pull the lever back towards you to switch off the high beam.

Headlight flasher

- Pull the lever toward the steering wheel  to use the headlight flasher.

Notes on these features

- The *turn signals* only work with the ignition switched on. The indicator lights  or  in the instrument cluster \Rightarrow *page 11* also blink.
- After you have turned a corner, the turn signal switches off automatically.
- The *high beam* works only when the headlights are on. The indicator light  in the instrument cluster illuminates when the high beams are on.
- The *headlight flasher* works only as long as you hold the lever - even if there are no lights switched on. The indicator light  in the instrument cluster illuminates when you use the headlight flasher.

Note

Do not use the high beam or headlight flasher if you know that these could be blinding oncoming traffic. ■

Interior lights

Interior lights and glove compartment light

The interior lights include the both reading lights for the driver and the front passenger.

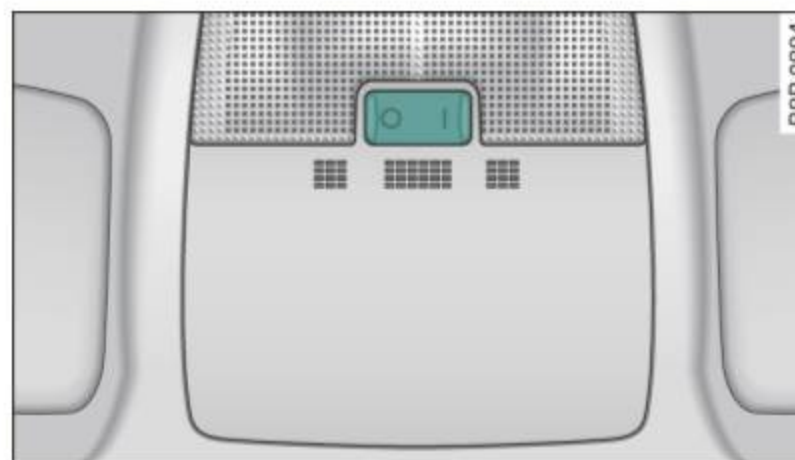

Fig. 55 Control panel above windshield: interior light switches

Light switch \Rightarrow fig. 55 has the following functions:

Door contact activation

- Move the switch to the center position. The forward dome light is turned on/off by the contact switches on any of the doors.

Forward dome light on

- Move the switch to position **I**. The forward dome light goes on and stays on regardless of door position. ►

Forward dome light off

- Move the switch to position **O**. The light will not go on regardless of door position.

Glove compartment light

- Open the glove compartment - the light in the glove compartment automatically illuminates as long as the side marker lights or headlights are on. When you close the glove compartment, the light goes off.

With the interior light switch at the door contact (center) position, the forward dome light illuminates whenever you unlock the vehicle or open a door. The dome light goes out after approximately 30 seconds after you have closed the door. Likewise, when you lock your vehicle or switch on the ignition, the dome light goes out.

If you leave a door open, the dome light will go out after ten minutes to conserve battery charge.

A dimmer automatically controls the brightness of the lights when they are switched on. ■

Applies to vehicles: with light package

Interior lights and forward reading lights

The interior lights include the both reading lights for the driver and the front passenger.

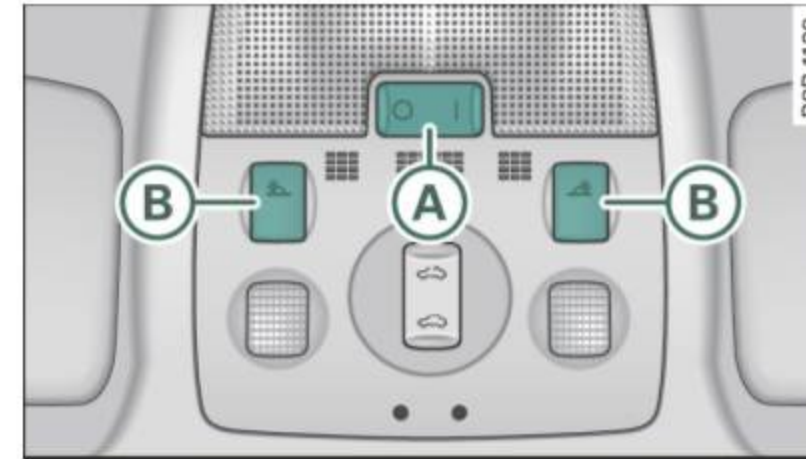

Fig. 56 Control panel above windshield: interior light switches

Light switch **A** ⇒ page 60, fig. 55 has the following functions:

Door contact activation

- Move the switch to the center position. The forward dome light is turned on/off by the contact switches on any of the doors.

Forward dome light on

- Move the switch to position **I**. The forward dome light goes on and stays on regardless of door position.

Forward dome light off

- Move the switch to position **O**. The light will not go on regardless of door position. ►

Forward reading lights

- Press the left or right switch **(B)** to switch the left or right forward reading light on or off.

Glove compartment light

- Open the glove compartment - the light in the glove compartment automatically illuminates as long as the side marker lights or headlights are on. When you close the glove compartment, the light goes off.

With the interior light switch at the door contact (center) position, the forward dome light illuminates whenever you unlock the vehicle or open a door. The dome light goes out after approximately 30 seconds after you have closed the door. Likewise, when you lock your vehicle or switch on the ignition, the dome light goes out.

If you leave a door open, the dome light will go out after ten minutes to conserve battery charge.

A dimmer automatically controls the brightness of the lights when they are switched on. ■

Applies to vehicles: with light package

Ambient lighting

The ambient lighting illuminate important controls for you.



Fig. 57 Control panel above windshield: position of ambient light bulbs

When you switch on the ignition, the lights in the door handles illuminate.

When the side marker lights or headlights are switched on, the center console is illuminated from the ambient light located above the windshield.

You cannot manually turn off these lights. ■

Rear reading light

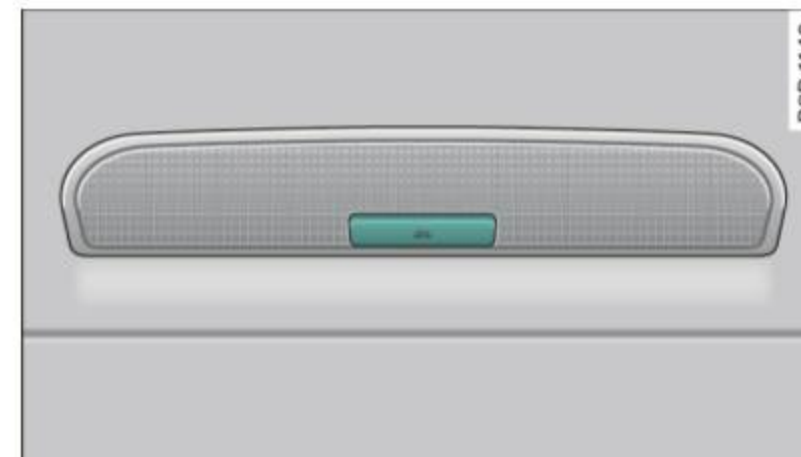



Fig. 58 Rear reading light

Rear reading light

Press the switch  to turn on and off the reading light. ■

Luggage compartment light

A dome light in the rear roof liner illuminates the luggage compartment. An additional light is provided on the inside of the rear lid.

The light is located on the left side of the trunk.

With the switch at the center position, the rear dome light is automatically switched on as soon as the rear lid is opened. The rear dome light goes out 30 seconds after the rear lid is closed.

If the rear lid is left open for more than 10 minutes, both the rear dome light and the light in rear lid are switched off to conserve the battery charge. ■

Vision

Applies to vehicles: with light package or illuminated vanity mirror

Sun visors

Using the sun visors makes driving safer.

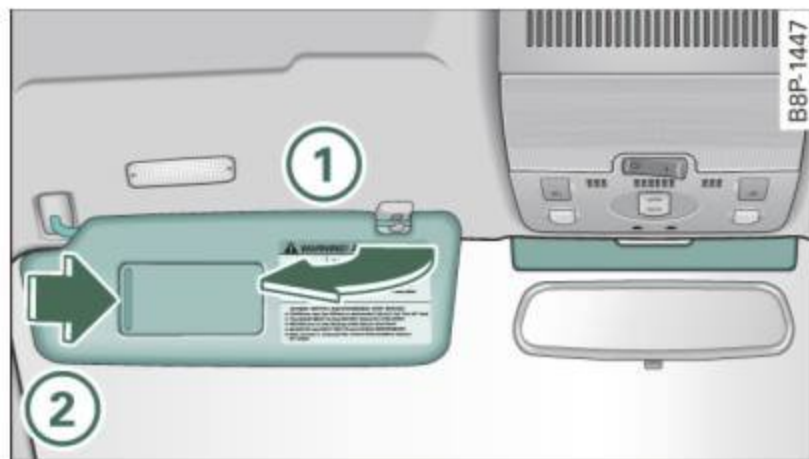



Fig. 59 Sun visor

The sun visors for the driver and front passenger can be removed from their center mountings and moved toward the door windows  ⇒ fig. 59 to protect against side glare.

The vanity mirror in the sun visors is covered by a lid. When you slide the lid  open the mirror illumination comes on automatically. When you slide the lid shut or fold the sun visor back up, the illumination also goes out.

There is a folding visor between the visors for the driver and the passenger which can be used to cover the space above the rear view mirror. ■

Mirrors

Manual anti-glare adjustment

Standard setting

- Move the small lever (located on the bottom edge of the mirror) to the front.

Anti-glare setting

- Move the small lever (located on the bottom edge of the mirror) to the rear. ■

Applies to vehicles: with automatically dimming inside mirror

Automatically dimming inside mirror

The automatic dimming function can be turned on and off if required.

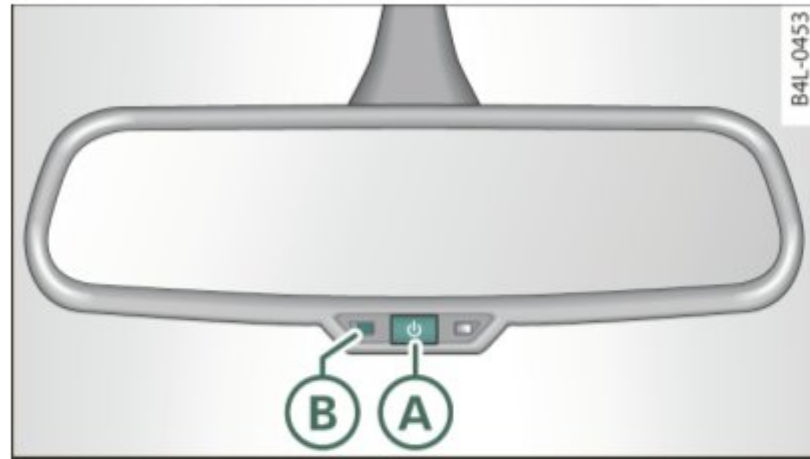

Fig. 60 Inside rear view mirror

Disabling auto dimming

- Press button **A** ⇒ fig. 60 *briefly*, - the green indicator light **B** goes out.

Activating/reactivating auto dimming

- Press button **A** *briefly*, - the green indicator light **B** goes on.

Automatic dimming function

The automatic dimming function is activated every time the ignition is turned on. The green indicator light is lit to indicate auto dimming is active.

When dimming is activated, the inside mirror will darken *automatically* in response to the amount of light striking the mirror (such as headlights from rearward approaching vehicles). Even in dimming mode, the mirror surface turns bright when:

- the interior light is switched on
- reverse gear is engaged.

⚠ WARNING

Broken glass of automatic dimming mirror can cause electrolyte fluid leakage. Electrolyte fluid can irritate skin, eyes, and respiratory system.

- Repeated or prolonged exposure to electrolyte can cause irritation to the respiratory system, especially among people with asthma or other respiratory conditions. Get fresh air immediately by leaving the vehicle or, if that is not possible, open windows and doors all the way.
- If electrolyte gets into the eyes, flush them thoroughly with large amounts of clean water for at least 15 minutes; medical attention is recommended.
- If electrolyte contacts skin, flush affected area with clean water for at least 15 minutes and then wash affected area with soap and water; medical attention is recommended. Thoroughly wash affected clothing and shoes before reuse.
- If swallowed and person is conscious, rinse mouth with water for at least 15 minutes. Do not induce vomiting unless instructed to do so by medical professional. Get medical attention immediately.

ⓘ Note

Liquid electrolyte leaked from a broken mirror glass will damage any plastic surfaces it comes in contact with. Clean up spilled electrolyte immediately with clear water and a sponge.

ⓘ Tips

- Check to make sure there are no objects preventing light from reaching the inside mirror.
- Do not attach any stickers to the windshield in front of the light sensor, as this would interfere with the automatic operation of the headlights and the automatic dimming of the inside mirror. ■

Outside mirrors

The outside mirrors are electrically adjusted (power mirrors)

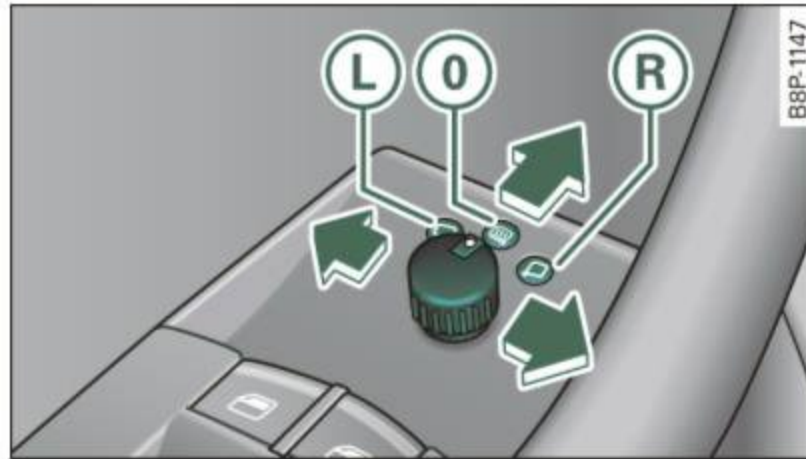

Fig. 61 Forward section of driver's armrest: power mirror controls

Adjusting the outside mirrors

- Turn the adjusting knob to ⇒ fig. 61 **L** (driver's side outside mirror) to **R** (front passenger's outside mirror).
- Press the knob in the appropriate direction to move the mirror surface so that you have a good view to the rear.

Heated mirrors*

- Turn the rotary knob to **0**.

Depending on outside temperature and vehicle speed, the mirror surfaces are heated until the ignition is switched off - even if the rotary knob is no longer in position **0**.

! Note

- Curved mirror surfaces (convex or spherical*) increase your field of view. Remember that vehicles or other objects will appear smaller and farther away than when seen in a flat mirror. If you use this mirror to estimate distances of following vehicles when changing lanes, you could estimate incorrectly and cause an accident.

i Tips

If there should be a malfunction in the electrical system, you can still adjust the outside mirrors by pressing the edge of the mirror. ■

Wiper and washer system

Windshield wiper

The windshield wiper lever controls both the windshield wipers and the washer system.

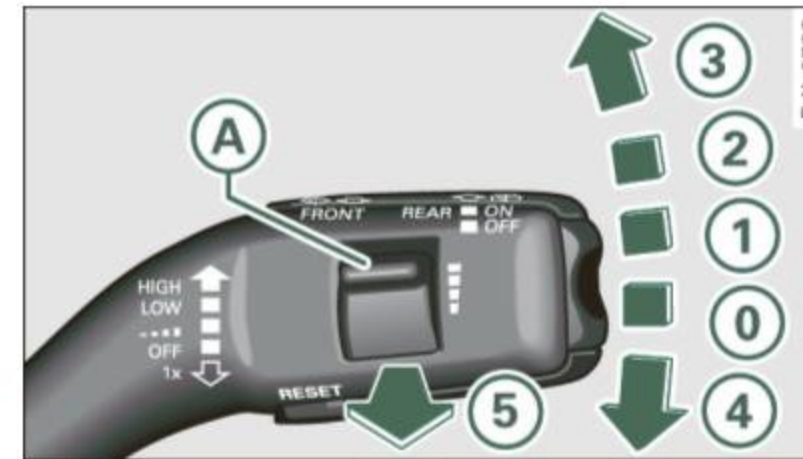

Fig. 62 Wiper lever: windshield wiper lever positions

The windshield wiper lever ⇒ fig. 62 has the following positions:

Intermittent wiping (activating rain sensor)*

- Move the lever up to position **1**.
- Move the interval set switch **A**, to change the intervals.

Low wiper speed

- Move the lever up to position **2**.

High wiper speed

- Move the lever up to position ③.

One-touch wiping

- Move the lever to position ④, when you want to wipe the windshield *briefly*.

Automatic wiper/washer

- Pull the lever to position ⑤ (toward the steering wheel) and hold.
- Release the lever. The washer stops and the wipers keep going for about four seconds.

Turning off the wipers

- Move the lever back to position ①.

The windshield wipers and washer only work when the ignition is turned on. If you switch off the ignition with the windshield wiper lever still in the interval wipe position and then come back a while later and drive off, the rain sensor will reactivate itself after the vehicle speed has exceeded 4 mph (6 km/h).

The rain sensor* is only activated with the wiper lever set to position ②. When it starts to rain, the rain sensor will automatically activate the intermittent wiping mode.

To reduce the sensitivity of the sensor, move switch ① down. To increase the sensitivity, move the switch up. The higher you adjust the sensitivity, the faster the sensor will react when it senses moisture on the windshield.

The rain sensor wiper intervals depend on the sensitivity setting as well as vehicle speed. During brief stops, wiper motion will adjust in relation to the amount of rain on the windshield.

Automatic wiper/washer: To eliminate water droplets, the windshield wiper performs one afterwipe operation after several seconds

while driving. You can switch this function off by moving the lever to position ⑤ within 10 seconds of the afterwipe operation. The afterwipe function is reactivated the next time the ignition is switched.

When the ignition is turned on, the washer jets are heated*.

WARNING

- **Wiper blades are crucial for safe driving! Only when they are in good condition are they able to clear the windows properly to provide uncompromised visibility. Worn or damaged wiper blades are a safety hazard ⇒ page 69, “Replacing front wiper blades”!**
- **The light/rain sensor* is only designed to assist and support the driver. It remains entirely the driver's responsibility to monitor outside weather conditions and to manually activate the wipers as soon as rain or drizzle reduces visibility through the windshield.**
- **The windshield must not be treated with water-repellent materials. They can increase glare under poor visibility conditions such as wetness, darkness, or when the sun is low on the horizon. In addition, they can cause the windshield wipers to chatter.**

Note

- In the case of frost, check whether the windshield wiper blades are frozen to the windshield. Switching on the windshield wipers can damage the wiper blades!
- Do not use the wipers to clear a frosted window. Using the wipers as a convenient ice scraper will destroy the wiper blades.
- Prior to using a car wash, the windshield wiper system must be switched off (lever in position 0). This helps to prevent unintentional switching on and damage to the windshield wiper system. ▶

Tips

- The windshield wipers are switched off when the ignition is turned off. Activate the windshield wipers after the ignition is switched back on by moving the windshield wiper lever to any position.
- Worn or dirty windshield wiper blades cause smearing, which can affect the operation of the light/rain sensor*. Check the condition of your windshield wiper blades regularly.
- The rain sensor is part of the interval wiping system. Turning off the ignition will also deactivate the rain sensor. To reactivate the sensor, switch off the interval wiping function, then switch it back on again.
- Applies to vehicles with light/rain sensor: When the wipers are switched on manually and in rain conditions, the automatic headlights* turn on ⇒ *page 56*, “Switching the headlights on and off ☀” or off during the day when the wipers are no longer operating. The automatic headlights* function is available in this case only when the light switch is in the “AUTO” position ⇒ *page 56*, fig. 49.
- Make sure the washer fluid reservoir in the engine compartment is topped off before going on a long trip. Look up ⇒ *page 243* for checking and filling the washer container.
- The wipers only operate with the hood completely closed. ■

Rear window wiper

The wiper lever is also used to operate the rear window wiper and the automatic wiper/washer function.



Fig. 63 Wiper lever: activating the rear window wiper and washer

The rear window wiper and the automatic wiper/washer functions are activated as follows:

Intermittent wiping

- Push the wiper lever forward towards the dashboard and to the *first* position **6** ⇒ fig. 63. The rear window wiper will wipe the window approx. every four seconds.

Automatic wiper/washer function

- Push the wiper lever forward to the *second* stop, position **7**, and hold it there for as long as you want the rear wiper/washer to operate.
- Release the lever again. The wiper will keep running for approx. four seconds.

Switching intermittent wiper action off

- Pull the lever all the way back to the original position. ►

 **WARNING**

Wiper blades are crucial for safe driving! Only in good condition are they able to clear the windows properly to provide unrestricted visibility. Worn or frayed wiper blades are a safety hazard!
⇒ *page 69, "Replacing front wiper blades"*

 **Note**

In freezing or near freezing conditions:

- Always check that the wiper blades are not frozen to the glass before you turn the wiper on. Loosen a wiper blade which is frozen in place before operating the wiper to prevent damage to the wiper blade or the wiper motor.
- Do not use the wiper to clear a frosted window. Using the wipers as a convenient ice scraper will destroy the wiper blades.

 **Tips**

For better rearward vision when parking, the rear window wiper is automatically activated one time when the windshield wipers are switched on and reverse gear is engaged. ■

Service position

Replacing the windshield wiper blades is only possible when you move the wiper arms into the service position. In order to use the windshield wipers, the hood must be completely closed. When there is a risk of frost, make sure that the wiper blades are not frozen to the windshield.

- Switch the ignition on.

- Switch the ignition off again and move the wiper lever ⇒ *page 65, fig. 62* from position **0** to **1** within 10 seconds. The wiper arms now move into the field of view in the windshield.

The service position can also be selected in the driver information system* ⇒ *page 22*.

 **Note**

Never drive your vehicle when the windshield wiper arms are in the service position and pulled away from the windshield. When you drive faster than 4 mph (6 km/h), the wiper arms automatically return back to the park position and could cause paint damage to the engine hood!

 **Tips**

- You can also turn on the service position, for example, if you want to protect the windshield from icing by using a cover.
- The service position moves to **off** automatically when you operate the windshield wiper lever, or speed exceeds 4 mph (6 km/h). ■

Replacing front wiper blades

Wiper blades in good condition help keep the windshield clear.



Fig. 64 Unlatching wiper blades

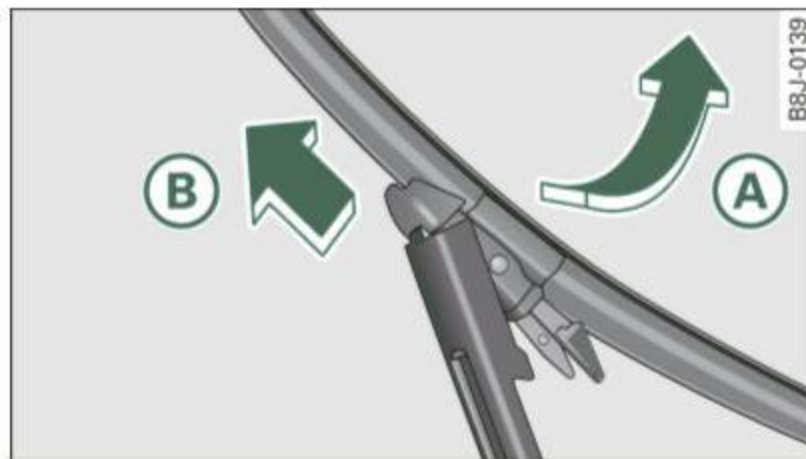

Fig. 65 Removing wiper blades

Removing the wiper blade

- Move the wipers to the service position ⇒ *page 68*.
- Fold the windshield wiper arm away from the glass.
- On the upper end of the wiper arm at the corrugation, squeeze the plastic retainer together on both sides in the direction of the arrow ⇒ fig. 64.
- Rotate the wiper blade in the direction of the arrow (A) ⇒ fig. 65 away from the wiper arm.

- Lift the wiper blade off in the direction of the arrow (B).

Attaching the wiper blade

- Place the rounded end of the wiper onto the end of the wiper arm in the **opposite** direction to the arrow (B) ⇒ fig. 65.
- Swing the wiper in the **opposite** direction to the arrow (A) onto the wiper arm.
- Squeeze the corrugation on the wiper until you hear it click in the wiper arm.
- Fold the wiper arm back onto the windshield.
- Switch the ignition on and move the wiper lever down briefly. The wiper will move back to the park position.

The front wiper blades measure left side 23.20 in. (590 mm) and right side 18.50 in. (470 mm) in length,

Clean your wiper blades regularly with a windshield washer solution to prevent streaking. If the blades are very dirty, for example with insects, carefully clean the blades with a sponge or a soft brush.

If the wiper blades begin to streak the windshield, this could be caused by residue left on the windshield by automatic car washes.

Fill the windshield washer container with a special solution available at your authorized Audi dealer to remove the residue.

Be sure to inspect the condition of your wiper blades regularly. For safety reasons, replace your wiper blades once or twice a year if necessary. See your authorized Audi dealer for replacement blades.

WARNING

- Clean your wiper blades regularly with a windshield washer solution to prevent streaking. If the wiper blades are very dirty,

⚠ WARNING (continued)

for example with insects, carefully clean the wiper blades with a sponge or a soft brush.

- For your safety, you should replace the wiper blades once or twice a year. See your authorized Audi dealer for replacement blades.

! Note

- The wiper blades may only be changed ⇒ *page 68* in the service position! Otherwise, you risk damaging the paint on the hood or the windshield wiper motor.
- You should not move your vehicle or press the windshield wiper lever when the wiper arms are folded away from the windshield. The windshield wipers would move back into their original position and could damage the hood and windshield.
- To help prevent damage to the wiper system, always loosen blades which are frozen to the windshield before operating wipers.
- To help prevent damage to wiper blades, do not use gasoline, kerosene, paint thinner, or other solvents on or near the wiper blades.
- To help prevent damage to the wiper arms or other components, do not attempt to move the wipers by hand.

i Tips

- Commercial hot waxes applied by automatic car washes affect the cleanability of the glass surface.
- You can also use the service position, for example, if you want to protect the windshield from icing by using a cover.
- You cannot activate the service position when the hood is open.
- The front wiper blades are different lengths; the blade on the driver's side is longer. ■

Changing the rear wiper blade

Fig. 66 Installing/re moving wiper blade

Removing the wiper blade

- Fold the windshield wiper arm away from the glass.
- Pull the metal surround of the wiper blade out of the retainer in the direction of the arrow ⇒ *fig. 66*. Hold the wiper arm firmly by the upper end as you do this.

Attaching the wiper blade

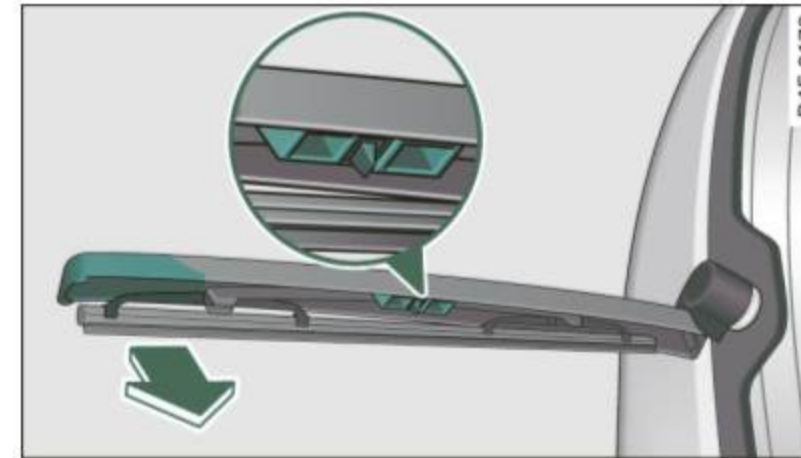
- Adjust the position of the wiper blade in the retainer ⇒ *fig. 66* (see close up).
- Press the wiper blade into the retainer. Hold the wiper arm firmly by the upper end as you do this.
- Fold the wiper arm back onto the glass.

⚠ WARNING

- To avoid streaks, you should clean the windshield wiper blades regularly with window cleaner. For heavy soiling, for example, insects, the wiper blades can also be cleaned with a sponge or a cloth. ▶

⚠ WARNING (continued)

- For safety reasons, the windshield wiper blades should be replaced once or twice a year. ■

Digital compass

Applies to vehicles: with digital compass

Activating or deactivating the compass

The direction is displayed on the interior rear view mirror.

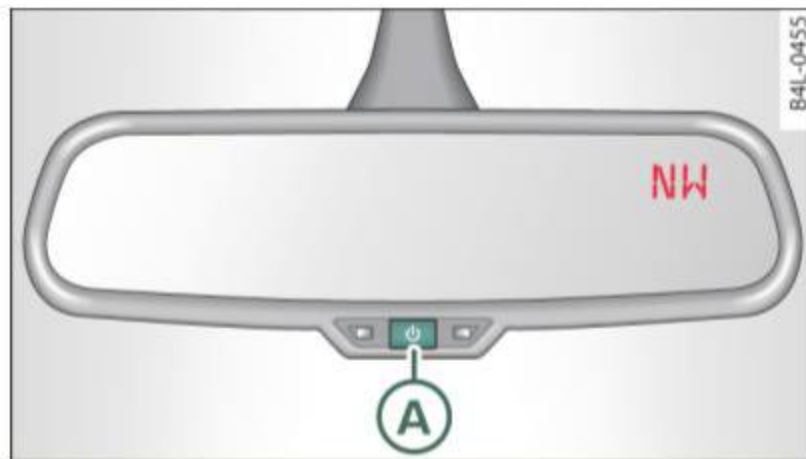

Fig. 67 Inside rear view mirror: digital compass activated

- To activate or deactivate, hold the **A** button down until the red display appears or disappears.

The digital compass only works with the ignition turned on. The directions are displayed as initials: **N** (North), **NE** (Northeast), **E** (East), **SE** (Southeast), **S** (South), **SW** (Southwest), **W** (West), **NW** (Northwest).

i Tips

To avoid inaccurate directions, do not allow any remote controls, electrical systems, or metal parts close to the mirror. ■

Applies to vehicles: with digital compass

Setting the magnetic deflection zone

The correct magnetic deflection zone must be set in order to display the directions correctly.



Fig. 68 North America: magnetic deflection zone boundaries

- Hold the **A** ⇒ fig. 67 button down until the number of the set magnetic deflection zone appears on the interior rear view mirror.
- Adjust the magnetic deflection zone by repeatedly pressing on the **A** button. The set mode automatically deactivates after a few seconds. ■

Applies to vehicles: with digital compass

Calibrating the compass

The compass has to be recalibrated if the display is wrong or inaccurate.

- Hold the **(A)** button down until the letter **C** is displayed on the interior rear view mirror.
- Drive in a circle at a speed of about 5 mph (10 km/h) until a direction is shown on the interior rear view mirror.

WARNING

The digital compass is to be used as a directional aid only. Even though you may want to look at it while you are driving, you must still pay attention to traffic, road and weather conditions as well as other possible hazards. ■

Seats and storage

General recommendations

Why is your seat adjustment so important?

The safety belts and the airbag system can only provide maximum protection if the front seats are correctly adjusted.

There are several different ways you can adjust the driver's seat and the front passenger's seat so that it conforms to your body size. It is especially important that the seat be adjusted properly so that:

- you can easily and quickly reach all the switches and controls in the instrument panel
- your body is properly supported thus reducing physical stress and fatigue
- the safety belts and airbag system can offer maximum protection ⇒ *page 145*

In the following chapters, you will see exactly how you can best adjust your seats.

There are special regulations and instructions for installing a child safety seat on the front passenger's seat. Always heed the information regarding child safety provided in ⇒ *page 167*, "Child Safety".

WARNING

Incorrect seating position of the driver and all other passengers can result in serious personal injury.

- **Always keep your feet on the floor when the vehicle is in motion – never put your feet on top of the instrument panel, out of the window or on top of the seat cushion! This applies especially to the passengers. If your seating position is incorrect you increase the risk of injury in the case of sudden braking or an acci-**

WARNING (continued)

dent. If the airbag inflates and the seating position is incorrect this could result in personal injury or even death.

- **It is important for both the driver and front passenger to keep a distance of at least 10 inches (25 cm) between themselves and the steering wheel and/or instrument panel. If you're sitting any closer than this, the airbag system cannot protect you properly. In addition to this, the front seats and head restraints must be adjusted to your body height so that they can give you maximum protection.**
- **Always try to keep as much distance as possible between yourself and the steering wheel or instrument panel.**
- **Do not adjust the driver's or front passenger's seat while the vehicle is moving. Your seat may move unexpectedly, causing sudden loss of vehicle control and personal injury. If you adjust your seat while the vehicle is moving, you are out of position. ■**

Driver's seat

The correct seat position is important for safe and relaxed driving.

We recommend that you adjust the driver's seat in the following manner:

- Adjust the seat in fore and aft direction so that you can easily push the pedals to the floor while keeping your knees slightly bent ⇒  in "Why is your seat adjustment so important?".
- Adjust the seatback so that when you sit with your back against the seatback, you can still grasp the top of the steering wheel.

- Adjust the head restraint so the upper edge is as even as possible with the top of your head. If that is not possible, try to adjust the head restraint so that it is as close to this position as possible ⇒ *page 77*.

WARNING

Never place any objects in the driver's footwell. An object could get into the pedal area and interfere with pedal function. In case of sudden braking or an accident, you would not be able to brake or accelerate! ■

Front passenger's seat

Always move the front passenger seat into the rearmost position.

To avoid contact with the airbag while it is deploying, do not sit any closer to the instrument panel than necessary and always wear the three-point safety belt provided adjusted correctly. We recommend that you adjust the passenger's seat in the following manner:

- Move the front passenger seat into the rearmost position of the fore and aft adjustment range ⇒  in “Why is your seat adjustment so important?” on *page 73*.
- Bring the backrest up to an (almost) upright position. **Do not** ride with the seat reclined.
- Adjust the head restraint so the upper edge is as even as possible with the top of your head. If that is not possible, try to adjust the head restraint so that it is as close to this position as possible ⇒ *page 77*.
- Place your feet on the floor in front of the passenger's seat. ■

Adjusting front seats manually

Applies to vehicles: with manual seat adjustment

Adjustment controls

Various controls on the manual seats provide a wide range for individual adjustments.



Fig. 69 Adjustment controls: locations on driver's seat

- ① Moving the seat forward or backward
- ② Adjusting the seat height
- ③ Adjusting the seatback angle
- ④ Adjusting head restraint height

Some of the controls are fitted on certain models only or they are optional equipment. ■

Applies to vehicles: with manual seat adjustment

Adjusting the manual seats

Position, angle and shape of the manual seats can be adjusted to provide safe and comfortable seating.

Read and heed all **WARNINGS** ⇒  before you adjust your seat. ►

Moving the front seats forward or backward

- Lift the lever ⇒ page 74, fig. 69 ① and slide the seat to the desired position.
- Release the lever and then move the seat further until you feel and hear it engage.

Adjusting the seat height

- Pull the lever ② up and pump it to raise the seat.
- Push the lever down and pump it to lower the seat.

Adjusting the seatback angle

- Lean forward to take your weight off the seatback.
- Turn the hand wheel ④ in the direction you want the seatback to tilt.

WARNING

- **Never adjust the driver's or front passenger's seat while the vehicle is moving. If you do this while the vehicle is moving, you will be out of position. Always adjust the driver's or front passenger's seat when the vehicle is not moving.**
- **Be careful when adjusting the seat height. Check to see that no one is in the way, or serious injury could result!**
- **To reduce the risk of injury in the case of sudden braking or accident, front passengers must never ride in a moving vehicle with the seatback reclined. Safety belts and the airbag system only offer maximum protection when the seatback is upright and the safety belts are properly positioned on the body. The more the seatback is reclined, the greater the risk of personal injury from an incorrect seating position and improperly positioned safety belts! ■**

Adjusting the power seat

Applies to vehicles: with power driver seat

Adjustment switches

For an intuitive operation, the switches ① and ② are distinctly shaped and positioned to reflect their adjustment functions.

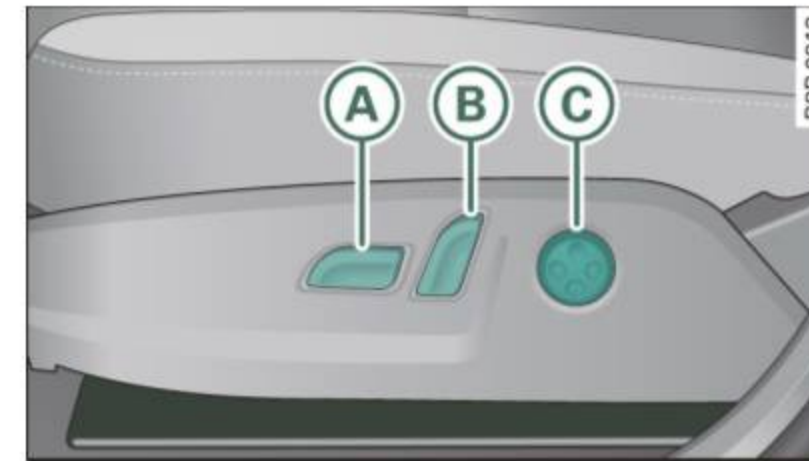

Fig. 70 Adjustment switches: locations on driver's seat

Push or pull either switch in exactly the same direction you like the corresponding part of the seat to move.

- ① Moving the seat forward or backward
- ② Adjusting the angle of the seatback and head restraints
- ③ Adjusting the lumbar support ■

Applies to vehicles: with power driver seat

Power seat adjustment

The switches can be moved in various directions to allow precise adjustment.

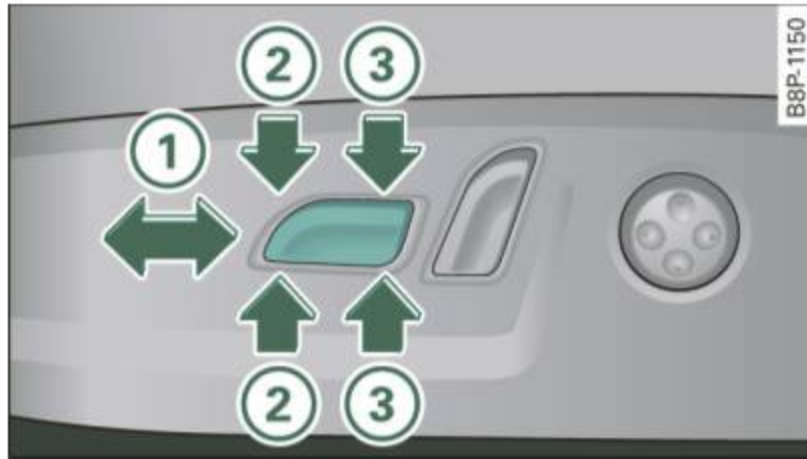

Fig. 71 Seat cushion adjustment: switch motions

Push or pull the switch in the same direction you like the seat cushion to move.

Moving the entire seatback or forward

- Push the switch back at the tip or forward at the rear (1) ⇒ ⚠.

Adjusting the seat height

- To raise the seat, pull the switch at both ends, (2) and (3) ⇒ ⚠.
- To lower the seat, push the switch down evenly, (2) and (3) ⇒ ⚠.

Tilting the seat cushion back or forward

- To tilt back the seat cushion, pull the switch at the front only, (2) ⇒ ⚠.
- Alternatively, push the switch at the rear only, (3) ⇒ ⚠.

- To tilt forward the seat cushion, push the switch at the front only (2) ⇒ ⚠.
- Alternatively, pull the switch at the rear only (3) ⇒ ⚠.

⚠ WARNING

- Never adjust the driver's seat while the vehicle is moving. If you do this while the vehicle is moving, you will be out of position. Always adjust the driver's seat when the vehicle is not moving.
- Be careful when adjusting the seat height. Check to see that no one is in the way, or serious injury could result!
- Because the driver seat can be electrically adjusted with the ignition key removed, never leave children unattended in the vehicle. Unsupervised use of the electric seat adjustments may cause serious injury. ■

Applies to vehicles: with power driver seat

Adjusting the seatback

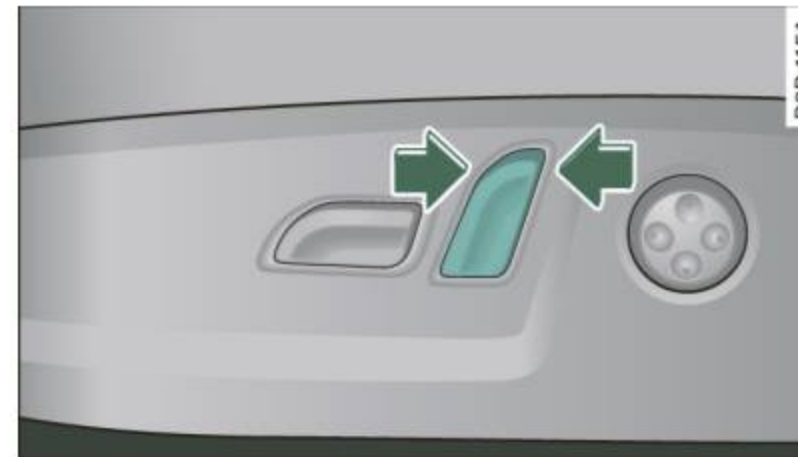

Fig. 72 Driver's seat: switch for seatback adjustment

- Push or pull the top of the switch in the same direction you like the seatback to tilt ⇒ fig. 72. ▶

WARNING

- Never adjust the seatback while the vehicle is moving. If you adjust your seatback while the vehicle is moving, you will be out of position. Always adjust the seatback when the vehicle is not moving.
- To reduce the risk of injury in the case of sudden braking or accident, front passengers must never ride in a moving vehicle with the seatback reclined. Safety belts and the airbag system only offer maximum protection when the seatback is upright and the safety belts are properly positioned on the body. The more the seatback is reclined, the greater the risk of personal injury from an incorrect seating position and improperly positioned safety belts! ■

Applies to vehicles: with lumbar support

Adjusting the lumbar support

The lumbar support can be adjusted to fit the natural curvature of the occupant's spine.



Fig. 73 Driver seat: switch for lumbar adjustment

Adjusting the curvature

- Push the front of the switch plate ⇒ fig. 73 in order to increase the curvature.

- Push the rear of the switch plate in order to decrease the curvature.

Adjusting the height

- Push on the top of the switch plate in order to move the support higher.
- Push on the bottom of the switch plate in order to move the support lower.

WARNING

Never adjust the lumbar support while the vehicle is moving. If you adjust your seat while the vehicle is moving, you will be out of position. Always adjust the lumbar support when the vehicle is not moving. ■

Head restraints

Front head restraints

The head restraints must be properly adjusted to the occupants's height to provide optimal restraint in combination with the seat restraints.

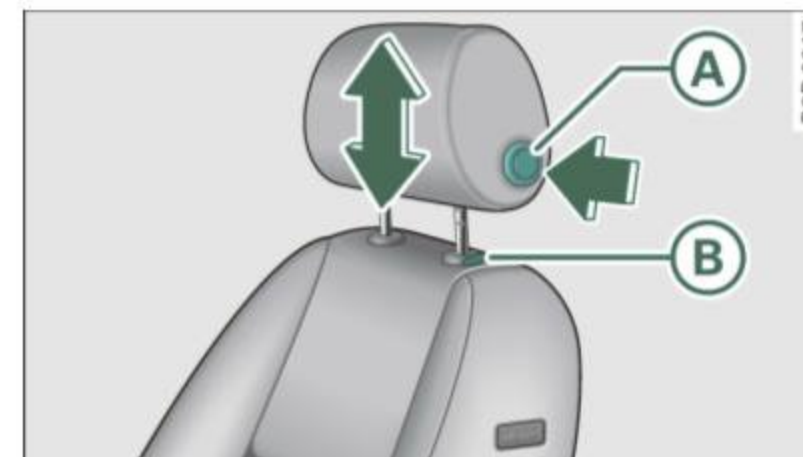

Fig. 74 Driver's seat head restraint: adjusting the height

Raising/lowering the head restraint

The head restraints on the *front* seats can be adjusted to provide safe support to head and neck at the optimum height. When optimally adjusted, the top of the restraint should be level with the top of the head. If that is not possible, try to adjust the head restraint so that it is as close to this position as possible ⇒ *page 128*, “Proper adjustment of head restraints”.

- To move the head restraint up, hold it at the sides with both hands and slide it upward until you feel it click into place.
- To move the head restraint down, press the button **A** and slide the head restraint downward until you feel it click into place ⇒ *page 77*, fig. 74.

Removing the head restraint

- Pull the head restraint all the way up.
- Press the release button **B** ⇒ *page 77*, fig. 74 and pull the restraint straight up and out of the seat.

Installing the head restraint

- Insert the rods into the guides and push the restraint back in until you hear it click.

Refer to ⇒ *page 128*, “Proper adjustment of head restraints” for guidelines on how to adjust the height of the front head restraints to fit the occupant's body size.

WARNING

- Driving without head restraints or with head restraints that are not properly adjusted increases the risk of serious or fatal neck injury dramatically.

WARNING (continued)

- Read and heed all WARNINGS ⇒ *page 128*.

Tips

Correctly adjusted head restraints and safety belts are an extremely effective combination of safety features. ■

Rear head restraints

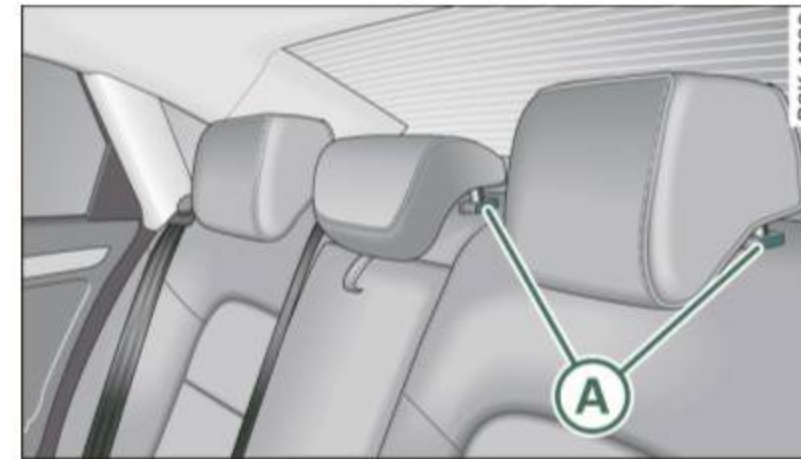

Fig. 75 Rear seat: head restraints



Fig. 76 Rear head restraints: release

If there is a passenger on the rear center seating position, slide the center head restraint upward at least to the next notch. ►

Adjusting the head restraints

- To move the head restraint up, hold it at the sides with both hands and slide it upward until you feel it click into place.
- To move the head restraint down, press the button **(A)** ⇒ page 78, fig. 75 and slide the head restraint downward.

Removing the head restraints²⁾

- Fold the backrest forward ⇒ page 81.
- Move the head restraint upward as far as it can go.
- Press the release **(B)** ⇒ page 78, fig. 76 with the screwdriver ⇒ page 270 and the button **(A)** ⇒ page 78, fig. 75. Pull the head restraint out of the backrest at the same time ⇒ .

Installing the head restraints

- Slide the posts on the head restraint down into the guides until you feel the posts click into place.
- Press the button **(A)** ⇒ page 78, fig. 75 and slide the head restraint all the way down. You should not be able to pull the head restraint out of the backrest.

So that the driver can have a better view to the rear, the head restraints should be pushed down completely when the rear seats are not occupied.

WARNING

- Only remove the rear seat head restraints when necessary in order to install a child seat. Install the head restraint again imme-

²⁾ The head restraints cannot be removed from rear seats with fixed backrests.

WARNING (continued)

diately once the child seat is removed. Driving without head restraints or with head restraints that are not properly adjusted increases the risk of serious or fatal neck injury dramatically.

- Read and heed all WARNINGS ⇒ page 128.

Tips

Correctly adjusted head restraints and safety belts are an extremely effective combination of safety features. ■

Center armrest

The front center armrest can be adjusted to several positions and contains a storage bin.



Fig. 77 Between the front seats: armrest folded down

Adjusting the armrest

- Push the armrest down.
- Lift the armrest slowly until it is in a comfortable position.

Opening the storage bin

- Pull the release button ⇒ fig. 77 upward. 

WARNING

When folded down, the armrest can restrict the driver's movement. When driving in conditions that may call for quick maneuvers, fold up the armrest. This will allow you to react more quickly to avoid an accident. ■

Rear seats

General information

Safe transportation of passengers on the rear seats requires proper safety precautions.

All passengers on the rear seats must be seated in compliance with the safety guidelines explained in ⇒ *page 135* and ⇒ *page 145*. The correct seating position is safety critical for front *and* rear seat passengers alike ⇒ *page 128*.

WARNING

- Vehicle occupants in the front *and* rear seats must always be properly restrained.
- Do not let anyone ride in the vehicle without the head restraints provided. Head restraints help reduce injuries.
- Loose items inside the passenger compartment, can fly forward in a crash or sudden maneuver and injure occupants. Always store articles in the luggage compartment and use the fastening eyes, especially when the rear seatbacks have been folded down.
- Read and heed and all WARNINGS ⇒ *page 128*, "Proper seating positions for passengers in rear seats". ■

Rear armrest

The armrest contains a storage compartment and a cupholder for 2 drinks.

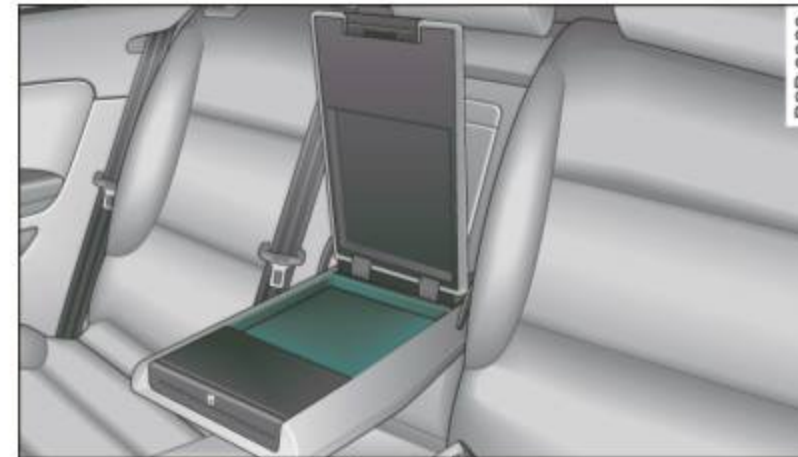

Fig. 78 Center of the rear seatbench: rear armrest folded down

Folding down the armrest

- Pull the armrest down on the front ⇒ fig. 78.

Opening the storage bin

- Pull the handle in front. ■

Luggage compartment

Increasing the size of the luggage compartment

To increase the size of the luggage compartment, both parts of the seatback can be folded forward, individually or together.

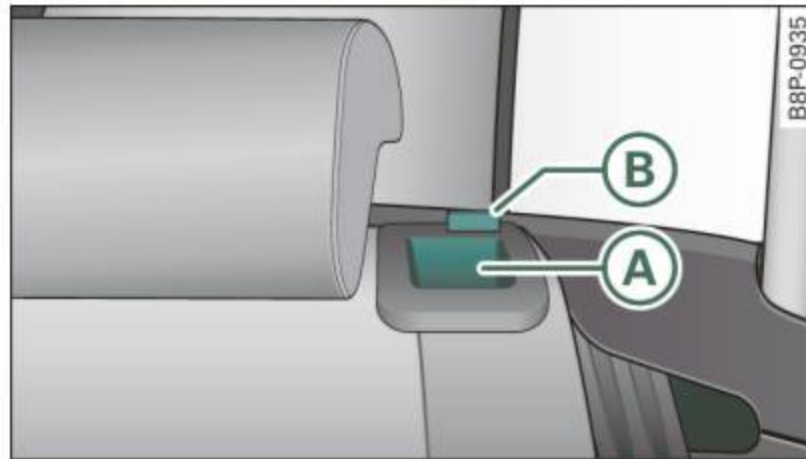

Fig. 79 Release lever for the seatback (left side)



Fig. 80 Rear seatback folded forward (with pass-through*)

Folding the seatback forward

- Let the backrest latch into the lowest position.
- Swing the outer rear head restraints forward ⇒ *page 78*, fig. 75.

- Push the release lever ⇒ fig. 79 (A) in the direction of the arrow.
- Tilt the seatback forward.

Raising the seatback

- Raise the seatback until it is securely latched ⇒ . When you can no longer see the red mark on the pin (B), the seat is latched.

Stowing luggage

- For safe loading and securing of items read and follow the guidelines on ⇒ *page 131*, “Loading the luggage compartment”.

The rear seatback is divided into two segments – one third/two thirds. You can fold down either or both parts of the seatback.

WARNING

- The backrest must always be securely latched so that the safety belt of the center seating position can work properly to help protect the occupant.
- The backrest must be securely latched in position so that no items contained in the luggage compartment can slide forward upon sudden braking.
- Never allow safety belts to become damaged by being caught in door or seat hardware.
- Torn or frayed safety belts can tear and damaged belt hardware can break in a crash. Inspect the belts periodically. Belts showing damage to webbing, bindings, buckles, or retractors must be replaced.

WARNING

Always read and heed WARNINGS ⇒  in “Loading the luggage compartment” on page 131.

Note

- If you move the front seat back when the rear seat backrest is folded forward, you could damage the head restraints on the rear seat.
- When folding the backrest back into place, make sure the safety belt does not get caught, because it can be damaged. A damaged belt can fail to provide safe restraint. ■

Fastening eyes

The luggage compartment is equipped with four tie-down eyelets to secure luggage and other items.

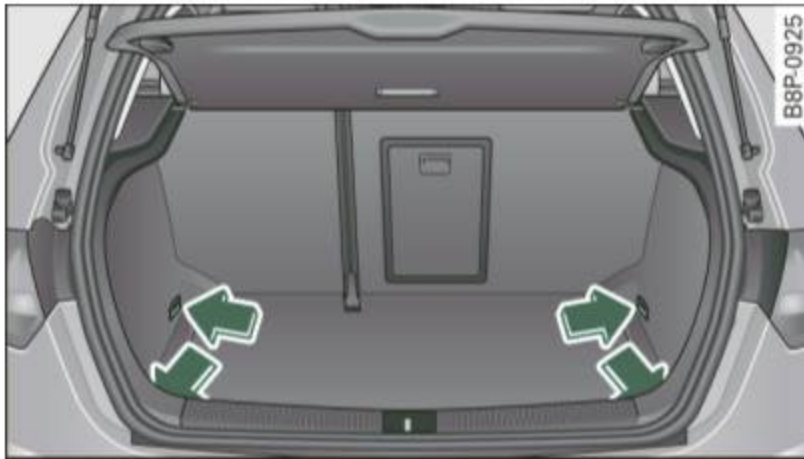

Fig. 81 Luggage compartment: fastening eyes

- Use the fastening eyes to secure your cargo properly ⇒ fig. 81 -arrows-.
- Adhere to all safety instructions ⇒ page 131, “Stowing luggage”.

In a collision, the laws of physics mean that even smaller items that are loose in the vehicle will become heavy missiles that can cause serious injury. Items in the vehicle possess energy which vary with vehicle and the weight of the item. The vehicle speed is the most significant factor.

For example, in a frontal collision at a speed of 30 mph (48 km/h), the forces acting on a 10 lbs (4,5 kg) object are about 20 times the normal weight of the item. This means that the weight of the item would suddenly be about 200 lbs (90 kg). You can imagine the injuries that a 200 lbs (90 kg) item flying freely through the passenger compartment could cause in a collision like this.

WARNING

Weak, damaged or improper straps used to secure items to fastening eyes can fail during hard braking or in a collision and cause serious personal injury.

- Always use suitable mounting straps and properly secure items to the fastening eyes in the luggage compartment to help prevent items from shifting or flying forward.
- When the rear seat backrest is folded down, always use suitable mounting straps and properly secure items to the fastening eyes in the luggage compartment to help prevent items from flying forward into the passenger compartment.
- Never attach a child safety seat tether strap to a fastening eye. ■

Applies to vehicles: with cargo net

Elastic cargo net

The cargo net prevents light objects from sliding around in the luggage compartment.

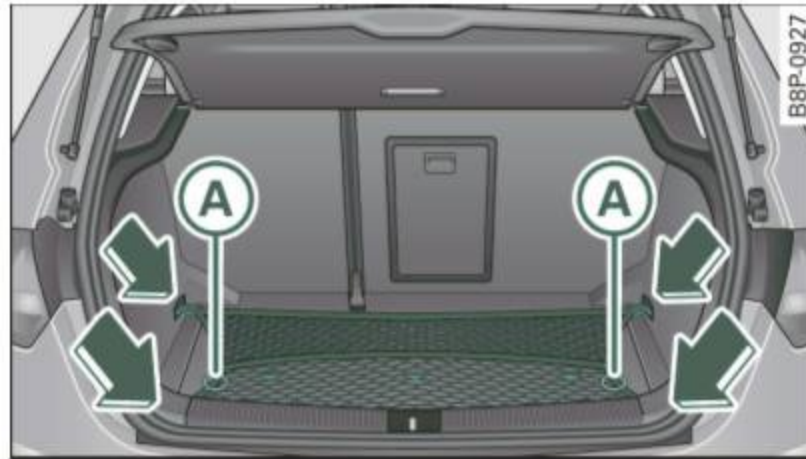

Fig. 82 Luggage compartment: cargo net

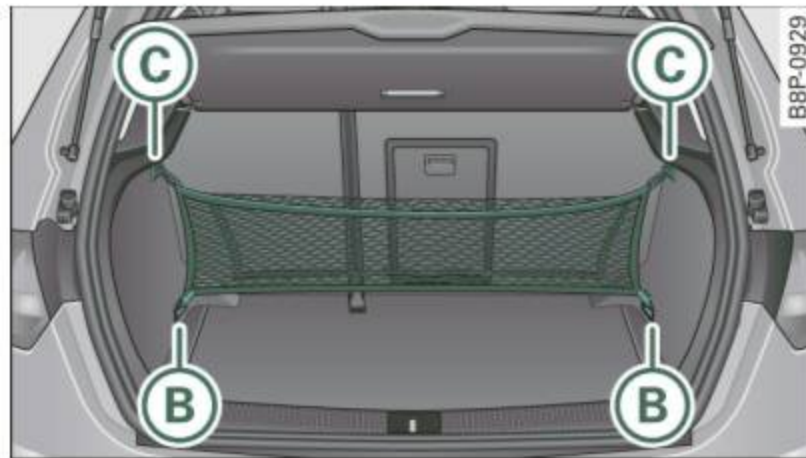

Fig. 83 Luggage compartment: cargo net attached to hooks

Securing objects to the luggage compartment floor with the net

- Lay out the cargo net in the luggage compartment.
- Engage all four hooks into the fastening eyes ⇒ fig. 82.
- Place objects to be secured *under* the net.

Configuring the net to contain small objects

- Lay out the cargo net in the luggage compartment.
- Engage two hooks into the fastening eyes (B) ⇒ fig. 83.
- Pull the net up and secure the eyes (C) on the hooks.
- Put items *into* the net.

The bottom of the cargo net can also be hooked to the D-rings in the floor of the rear compartment and the top to the eyes on the left and right side trim.

WARNING

For strength-related reasons, the mounting hooks can only be used to secure objects weighing 10 lb (5 kg) or less. Heavier objects will not be adequately secured – risk of injury! ■

Applies to vehicles: with mounting hooks

Mounting hooks



Fig. 84 Mounting hooks under the rear parcel shelf

The hook prevents lightly loaded bags from tipping over. ►

WARNING

For strength-related reasons, heavy objects must not be hung on the hooks. Heavy objects are not adequately secured - this increases the risk of injury. ■

Retractable luggage compartment cover

The luggage compartment cover keeps luggage or other objects out of view.

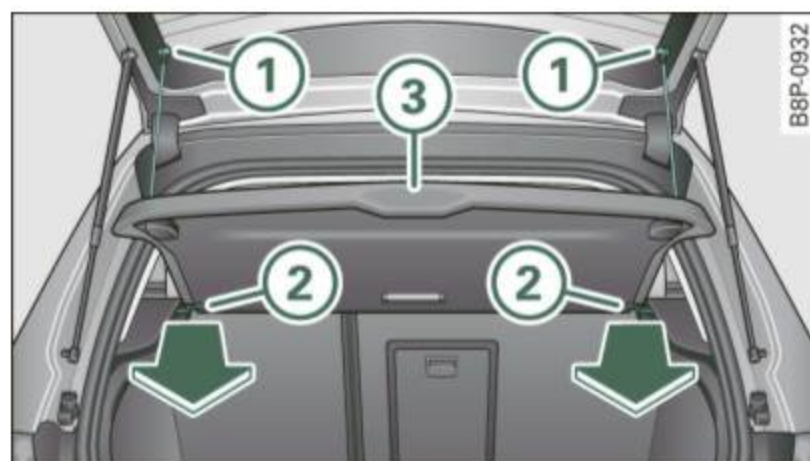



Fig. 85 Rear lid open with luggage compartment cover

Removing the luggage compartment cover

- Detach the retaining straps ⇒ fig. 85 at the rear hatch ①.
- Pull the cover ③ horizontally out of the mount ② in the direction of the arrow.

Installing the luggage compartment cover

- Push the cover horizontally into the mounts provided ⇒ fig. 85 ② on the side panel until the cover seats.
- Install the retaining straps in the rear hatch ⇒ fig. 85 ① ⇒ .

WARNING

- The luggage compartment cover must never be installed without being secured - this creates an accident hazard.
- Whenever driving, never place any hard or heavy objects on the luggage compartment or allow pets to sit on the luggage compartment cover. They could become a hazard to vehicle occupants in the event of sudden braking or in an accident.

Note

Make sure that the heating wires in the rear lid do not get damaged by objects scraping against them.

Tips

- You can use the luggage compartment cover to store light weight clothing but do not leave any heavy or sharp objects in the pockets of the clothing.
- Remember that placing clothing on the luggage compartment cover can block the driver's vision in the rear view mirror. This also applies especially when you have to transport large objects.
- So that stale air can escape from the vehicle be sure not to cover the ventilation slot between the rear lid and the luggage compartment cover installed. ■

Applies to vehicles: with ski sack

Ski sack

The ski sack allows a maximum of 4 pairs of skis or 2 snowboards to be carried inside the vehicle.

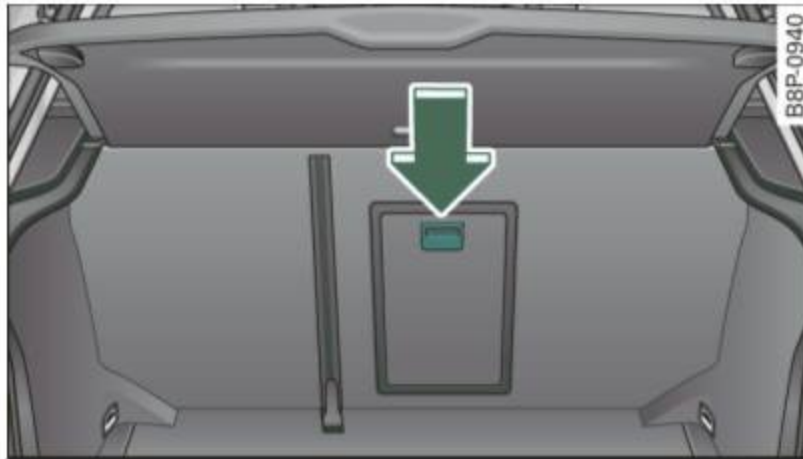

Fig. 86 Section of the rear seat from the rear: ski sack hatch cover

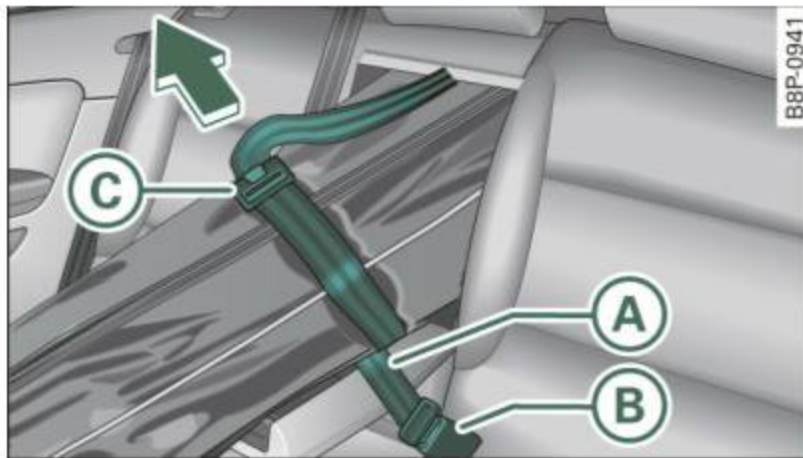

Fig. 87 Securing the ski sack at the center rear seat belt buckle

Loading

- Open the rear hatch.
- Slide the release button for the pass-through down (with the center armrest) ⇒ fig. 86 -Arrow- and tilt the pass-through forward.
- Remove the sack from the luggage compartment and unfold it.

- Place the empty sack in the hatch so that the end with the zip fastener is in the luggage compartment.
- Load objects from the luggage compartment into the ski sack.

Securing

- Insert the ski sack strap ⇒ fig. 87 (A) into the center seat belt buckle (B).
- With skiing items, place the strap in the middle between the bindings ⇒ ⚠.
- Pull the loose end of the strap tight in the direction of the arrow.

Opening the safety strap buckle

- Take the long sides of safety strap buckle between thumb and forefinger ⇒ fig. 87 (C).
- Squeeze the buckle and pull it away from the cargo.

Stowing

- Raise the pass-through until it is securely latched. It is secure when you can no longer see the red mark on the latch in the luggage compartment.
- Carefully fold up the empty (dry) ski sack.
- Stow the ski sack in the luggage compartment so that it cannot slide around.

⚠ WARNING

- After loading, the ski sack must be secured with the strap.
- The safety strap must fit tightly around the cargo.

⚠ WARNING (continued)

- **Make certain that the safety strap lies in the middle between the bindings of the ski equipment (refer also to printed message on the ski sack).**

i Tips

- Place skis with the tips pointing **forward**, snowboards and ski poles with tip to the **rear** in the ski sack.
- If there are several pairs of skis in the ski sack, make certain that the bindings are at the same level.
- Be sure not to fold up or store the sack when it is still damp. ■

Roof rack* installation

First things first

A roof rack can be used to carry additional luggage on the roof. There are two different roof rack systems.

Separate roof racks are needed for vehicles without roof rails. Vehicles with standard roof rails* need additional cross bars to carry cargo. Both types of additional equipment are available at your authorized Audi dealer.

- Always read and follow the instructions provided by the roof rack manufacturer when the roof rack system must be installed.

If a roof rack or similar luggage carrying equipment is to be installed, please note the following:

Vehicles without roof rails

- Your vehicle has aerodynamic rain gutters molded into the roof. That is why only roof racks specially designed for the roof can be used.

We recommend using roof racks from the Audi original accessories program.

- These roof racks are the basis for a complete roof rack system. For safety reasons, some additional attachments are necessary to transport luggage, bicycles, surf boards, skis and small boats safely. All these components are available at your authorized Audi dealer.

Vehicle with roof rails

- The vehicle is equipped with *integrated roof railings*, which can be covered into roof rack by installing cross bars. Only install cross bars specifically designed for this vehicle.
- These bars are the basis for a complete roof rack system. Additional attachments are necessary to safely transport luggage, bicycles, surf boards, skis or small boats.
- All necessary hardware for these systems is available from your authorized Audi dealer.

When should the roof rack be removed?

- Before going through an automatic car wash (it is best to ask the car wash operator)
- When not in use (reduce fuel consumption, reduce wind noise and guard against theft)

⚠ WARNING

- **Use of an unapproved roof rack or incorrect mounting of an approved roof rack can cause the roof rack or the items carried on it to fall off the roof onto the road.**
- **Objects falling from the roof of a vehicle can cause a crash and personal injury.**
- **Only mount the system between the markings shown in ⇒ page 87, fig. 88 or ⇒ page 88, fig. 89.**
- **The roof rack system must be installed exactly according to the instructions provided.**

! Note

- Any damage to the vehicle caused by using roof racks or other types of cross bars that have not been approved by Audi for your vehicle, or incorrect roof rack installation, is not covered by the Warranty.
- Always check the roof rack mountings and hardware before each trip and during a trip to make sure everything is securely tightened. If necessary, retighten the mountings and check the entire system from time to time.
- After mounting a roof rack system, or when you transport objects on the roof of your vehicle, the height of the vehicle is naturally increased. Be careful when driving under low bridges or in park garages for example. This could cause damage to the vehicle and even the load. ■

Applies to vehicles: without roof rails

Attachment points without roof rails

The roof rack must be attached only at the locations marked.

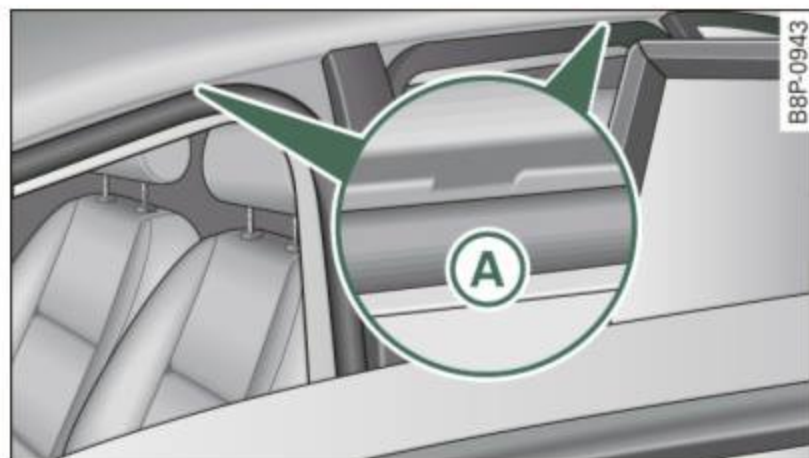

Fig. 88 Attachment points for roof rack

The attachment points ⇒ fig. 88 (A) can only be seen with the door open.

Introduction

- Clean the roof at the contact points for the roof rack in order to avoid paint scratches.
- Observe the identifying marks on the roof rack for front and rear, left and right.

Roof rack front

- Open the front doors ⇒ ⚠.
- Center the front of the roof rack in the two stamped marks at the front of the roof ⇒ fig. 88 (A), ⇒ ⚠.
- Hand tighten the mounting screws for the feet alternately on the **left** and **right** sides of the vehicle.
- Using the enclosed torque wrench, tighten the **front** mounting screws **securely** ⇒ ⚠.

Roof rack rear

- Open the rear doors ⇒ ⚠.
- Place the rear of the roof rack in the two stamped marks at the rear of the roof ⇒ fig. 88 (A), ⇒ ⚠.
- Hand tighten the mounting screws for the feet alternately on the **left** and **right** sides of the vehicle.
- Using the enclosed torque wrench, tighten the **rear** mounting screws **securely** ⇒ ⚠.

⚠ WARNING

- Always follow the instructions provided by the roof rack manufacturer.
- When installing the roof rack with the vehicle doors open, watch out for other traffic - there is the risk of an accident. ▶

⚠ WARNING (continued)

- **Make certain that the feet of the roof rack are sitting exactly in the four stamped marks - otherwise you risk an accident!**
- **After you have driven a few miles, and particularly during long trips, inspect the attaching screws to make certain they are tight.**
- **Do not make any modification to the roof rack - you increase the risk of an accident. ■**

Applies to vehicles: with roof rails

Roof rack mounting locations

Roof racks must be installed only at the locations marked on the roof rails.

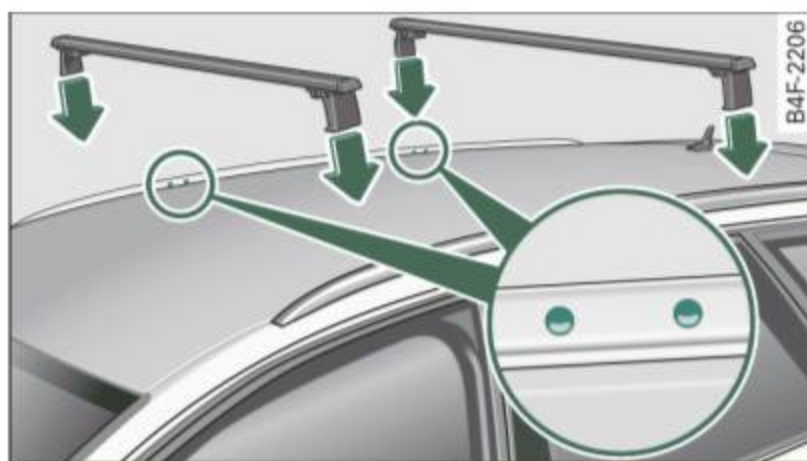

Fig. 89 Roof rails: front and rear mounting locations

Mounting

The roof rack system must be installed exactly according to the instructions provided.

Mount the front and rear cross bars between the punched markings on the inside of the roof railings ⇒ fig. 89 -arrows-.

! Note

- The conventional roof rack design illustrated above will not fit on vehicles without roof rails. For safe mounting, these require a different design of roof rack. ■

Loading the roof rack

Always distribute the loads evenly. Make sure anything on the roof rack is tied down securely.

- Always distribute the loads on the roof rack evenly.
- Always secure items to the roof rack.

The maximum permissible roof weight is **165 lb (75 kg)**. The roof weight is made up of the weight of the roof rack system and the weight of the object being transported ⇒ page 295.

When using a roof rack system which has a lower load carrying capacity, you must not use the total maximum permissible load carrying capacity. If this is the case, you may load the roof rack system only to the maximum capacity specified by the manufacturer of the roof rack system.

⚠ WARNING

Weak, damaged or improper straps used to secure items to the roof rack can fail during hard braking or in a collision and cause serious personal injury.

- **Always use suitable mounting straps and properly secure items to the properly installed roof rack to help prevent items from shifting or flying forward.**
- **Items on the roof rack must always be securely mounted.**
- **The use of a roof rack can negatively affect the way a vehicle handles. Cargo that is large, heavy, bulky, long or flat will have a greater negative influence on the vehicle's aerodynamics, center**

⚠ WARNING (continued)

of gravity and overall handling. Always drive slowly, avoid sudden braking and maneuvers when transporting cargo on the roof of your vehicle.

- Never exceed the maximum permissible load carrying capacity of the roof of your vehicle, the permissible axle weights and the permissible total weight of your vehicle ⇒ *page 295, "Weights"*.
- Always drive slowly, avoid sudden braking and maneuvers when transporting cargo on the roof of your vehicle.

**For the sake of the environment**

Sometimes it may be easier to leave a roof rack installed even though you are not using it. Due to the increased air resistance your vehicle will unnecessarily use more fuel. Remove the roof rack if you are not going to use it. ■

Cup holders

Cup holders in the center console

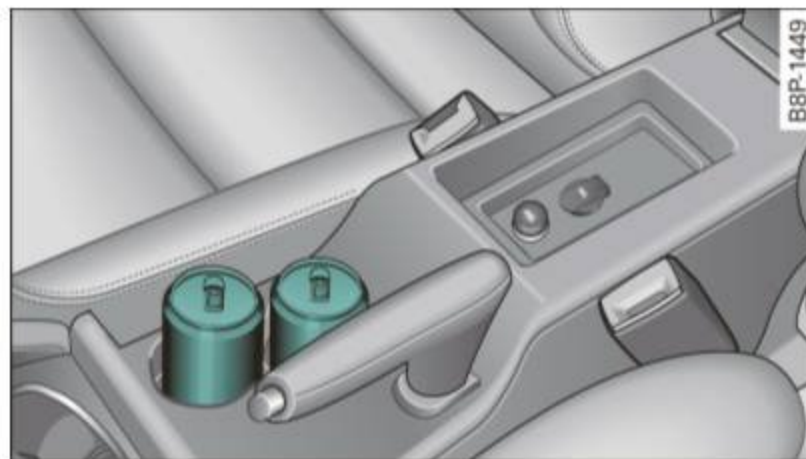

Fig. 90 Cup holders and storage tray in the center console

Up to two beverages can be placed in the center console.

⚠ WARNING

Spilled hot liquid can cause an accident and personal injury.

- Never carry any beverage containers with hot liquids, such as hot coffee or hot tea, in the vehicle while it is moving. In case of an accident, sudden braking or other vehicle movement, hot liquid could spill, causing scalding burns. Spilled hot liquid can also cause an accident and personal injury.
- Use only soft cups in the cupholder. Hard cups and glasses can cause injury in an accident.
- Never use the cupholder or adapter as an ashtray - risk of fire.

! Note

Only drink containers with lids should be carried in the cupholder. Liquid could spill out and damage your vehicle's electronic equipment or stain the upholstery, etc.. ■

Cupholder in the rear center armrest

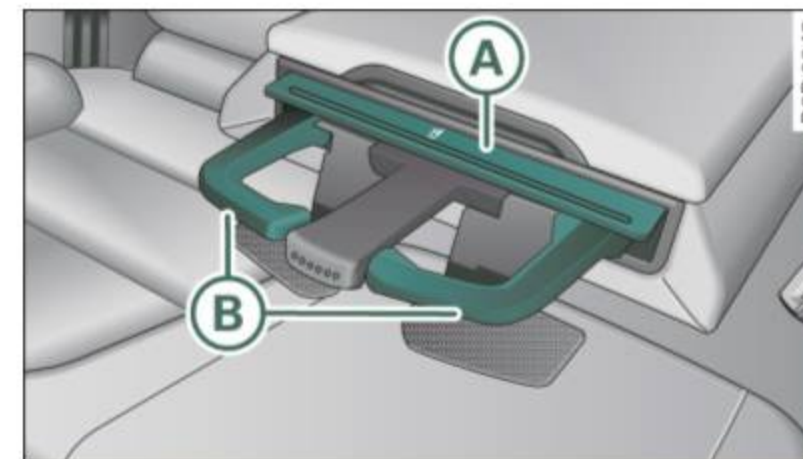



Fig. 91 Rear center armrest: cupholder extended

Opening the cup holder

- Press both spots marked with  **A** ⇒ fig. 91 ⇒ . The holder extends.

Adjusting the retainer individually

- Press and hold the retainer arm **(B)** inward -arrow- and adjust it to fit the cup size.

The retainer arm should fit snugly around the cup or can.

The cup holder is designed to secure no more than two cups or cans.

WARNING

Spilled hot liquid can cause an accident and personal injury.

- Never carry any beverage containers with hot liquids, such as hot coffee or hot tea, in the vehicle while it is moving. In case of an accident, sudden braking or other vehicle movement, hot liquid could spill, causing scalding burns. Spilled hot liquid can also cause an accident and personal injury.
- Use only soft cups in the cup holder. Hard cups and glasses can cause injury in an accident.

Note

Only drink containers with lids should be carried in the cupholder. Liquid could spill out and damage your vehicle's electronic equipment or stain the upholstery etc. ■

Socket

Outlets

The outlet in the front center console and in the luggage compartment may be used for 12-volt appliances.

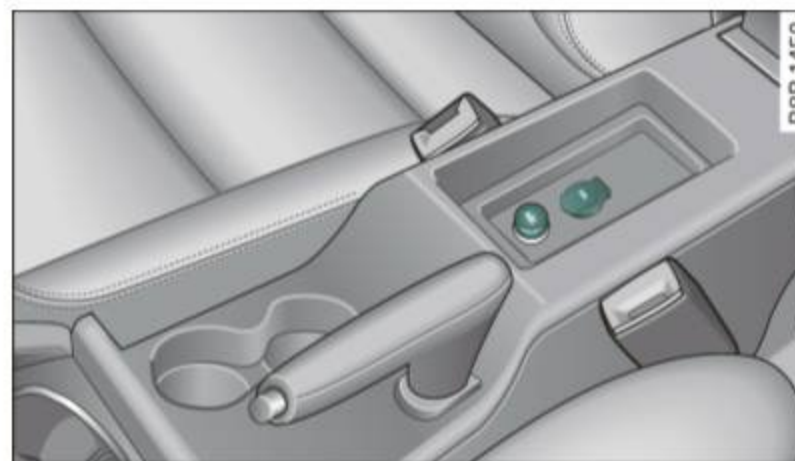

Fig. 92 Center console, front: 12-volt outlet



Fig. 93 Luggage compartment: 12-volt outlet

Outlet in the front center console

- Fold the cover for the outlet down ⇒ fig. 92.
- Plug in appliance to be used.

Outlet in the luggage compartment

- Tap cover ⇒ fig. 93.



- Plug in appliance to be used.

The outlet may be used for 12-volt appliances with maximum consumption of up to 100 watts, such as a flash light, small vacuum cleaner, etc.

Before you purchase any accessories, always read and follow the information in ⇒ page 301, "Additional accessories and parts replacement".

WARNING

The outlet plus any appliances plugged into it remain functional even if the ignition is switched off or the ignition key is removed. Never leave children inside the vehicle without supervision.

Note

To avoid damaging the socket, only use plugs that fit properly.

Tips

When the engine is off and accessories are still plugged in and are on, the vehicle battery can still be drained. ■

Storage

General overview

There are numerous places to store items in your vehicle.

Storage in the center armrest	⇒ page 79
Storage in the rear armrest	⇒ page 80
Glove compartment (Air ventilation in the glove compartment*, CD changer*)	⇒ page 92

Center console	⇒ page 92
Compartments in the door trims	⇒ page 93
Storage in the footwell	⇒ page 93
Compartments in luggage compartment	⇒ page 94
Coat hooks	⇒ page 94

Some of the storage locations are only found on specific vehicle models or are optional equipment.

WARNING

- Always remove objects from the instrument panel. Any items not put away could slide around inside the vehicle while driving or when accelerating or when applying the brakes or when driving around a corner.
- When you are driving make sure that anything you may have placed in the center console or other storage locations cannot fall out into the footwells. In case of sudden braking you would not be able to brake, depress the clutch or accelerate.
- Any pieces of clothing that you have hung up must not interfere with the driver's view. The coat hooks are designed only for lightweight clothing. Never hang any clothing with hard, pointed or heavy objects in the pockets on the coat hooks. During sudden braking or in an accident - especially if the airbag is deployed - these objects could injure any passengers inside the vehicle. ■

Glove compartment

The glove compartment is illuminated and can be locked.



Fig. 94 Glove compartment

To open glove compartment

- Pull the handle ⇒ fig. 94 in the direction of the arrow push down lid to the fully open position.

To close glove compartment

- Push the glove compartment lid upward until the lock engages.

The light will illuminate when the parking/headlights are turned on and the glove compartment is open.

In the glove compartment lid, you will find a place to store a pen and a pad of paper.

WARNING

To reduce the risk of personal injury in an accident or sudden stop, always keep the glove compartment closed while driving. ■

Applies to vehicles: with storage compartment in center console

Storage compartment for small objects



Fig. 95 Center console storage compartment

- To open the compartment, press the cover  ⇒ fig. 95.
- To close the compartment, push the drawer all the way in until it clicks in place.

An additional storage compartment³⁾ for relatively small objects is located in the center console next to the brake lever. ■

³⁾ Not available on vehicles with Audi Navigation System.

Compartments in the door trims

There are storage compartments in the door trims.

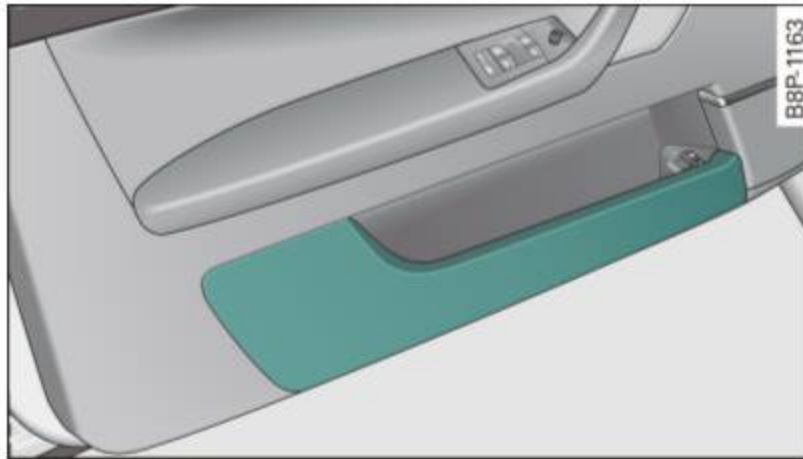

Fig. 96 Storage compartment in the door trim

WARNING

Always read and heed all WARNINGS ⇒ page 163, "Important safety instructions on the side airbag system". ■

Applies to vehicles: with storage net in footwell

Storage net in footwell

There is a storage net in the passenger's footwell.

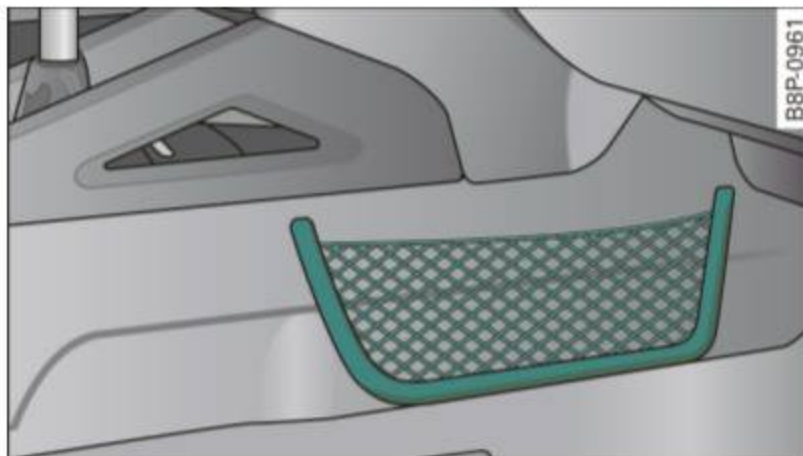

Fig. 97 Storage net in passenger's footwell

Tips

Do not keep any sharp or pointed objects in the storage net - they are a personal injury risk. ■

Applies to vehicles: with storage net in the front seatbacks

Storage net in the seatbacks

There is a storage net behind both front seatbacks.

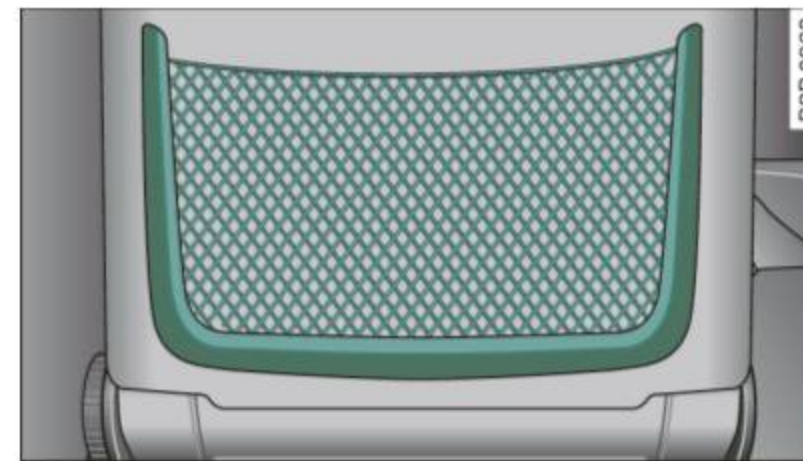

Fig. 98 Storage net on the driver's seatback

Tips

Do not keep any sharp or pointed objects in the storage net - this increases the risk of personal injury. ■

Applies to vehicles: with storage net in luggage compartment

Side storage in the luggage compartment

There is a compartment with a net on the right side of the luggage compartment.



Fig. 99 Side compartment in the luggage compartment

The compartment is suitable for holding small items. ■

Coat hooks

There is a coat hook above each rear door.



Fig. 100 Coat hook

The coat hooks are located in the headliner above each rear door.

WARNING

- Hang clothes in such a way that they do not impair the driver's vision.
- The coat hooks must only be used for light weight clothing. Do not leave any heavy or sharp edged objects in the pockets which may interfere with the side curtain airbag deployment and can cause personal injury in a crash.
- Do not use coat hangers for hanging clothing on the coat hooks as this can interfere with proper deployment of the side curtain airbags in an accident.
- Do not hang heavy objects on the coat hooks, as they could cause personal injury in a sudden stop. ■

Warm and cold

Climate controls

Description

The air conditioner is fully automatic and is designed to maintain a comfortable and uniform climate inside the vehicle.

We recommend the following settings:

- Select and set a temperature between 64 °F (+22 °C) and 84 °F (+28 °C).
- Press the **AUTO** button.

With this setting, you attain maximum comfort in the least amount of time. Change this setting, as desired, to meet your personal needs.

The climate controls are a combination of heating, ventilation and cooling systems, which automatically reduce humidity and cool the air inside your vehicle.

The air temperature, air flow and air distribution are automatically regulated to achieve and maintain the desired passenger compartment temperature as quickly as possible.

The system automatically compensates for changes in the outside temperature and for the intensity of the sunlight entering the vehicle. We recommend you use the **Automatic** mode ⇒ *page 98* for year-round comfort.

Please note the following:

Turn on the air conditioner to reduce humidity in the vehicle. This also prevents the windows from fogging up.

When the outside temperature is high and the air is very humid, **condensation** from the evaporator may drip under the vehicle. This is normal and does not indicate a leak.

If the outside temperature is low, the fan normally only switches to a higher speed once the engine coolant has warmed up sufficiently.

The air conditioner temporarily switches off when you drive off from a standstill using full throttle to save engine power.

The compressor also switches off if the coolant temperature is too high so that the engine can be adequately cooled under extreme loads.

Air pollutants filter

The air pollutants filter (a combined particle filter and activated charcoal filter) reduces or eliminates outside air pollution (dust, or pollen) from entering the vehicle.

The air pollutants filter must be changed at the intervals specified in your Warranty & Maintenance booklet, so that the air conditioner can properly work.

If you drive your vehicle in an area with high air pollution, the filter may need to be changed more frequently than specified in your Audi Warranty & Maintenance booklet. If in doubt, ask your authorized Audi Service Advisor for advice.

Energy management

To prevent the battery from being discharged and to restore the balance of energy, components which require large amounts of energy are temporarily cut back or switched off ⇒ *page 194*. Heating systems in particular require a great deal of energy. If you notice, for example, that the rear window heater is not heating, then it has been temporarily cut back or switched off by **energy management**. These systems are available again as soon as the energy balance has been restored.



WARNING

Reduced visibility is dangerous and can cause accidents.

 **WARNING** (continued)

- For safe driving it is very important that all windows be free of ice, snow and condensation.
- Fully familiarize yourself with the proper use and function of the heating and ventilation system and especially how to defog and defrost the windows.
- Never use the windshield wiper/washer system in freezing weather until you have warmed the windshield first, using the heating and ventilation system. The washer solution may freeze on the windshield and reduce visibility.

 **Note**

- If you suspect that the air conditioner has been damaged, switch off the air conditioner and contact an authorized Audi dealer to have the system inspected.
- Repairs to the Audi air conditioner require special technical knowledge and special tools. Contact an authorized Audi dealer for assistance.

 **Tips**

- Keep the air intake slots (in front of the windshield) free from ice, snow and debris in order to maintain the proper function of the climate control system.
- Air escapes through vents under the rear window. When placing items of clothing on the luggage compartment cover, ensure that the openings are not covered.
- If the inside temperature is very high (for example, if the vehicle has been parked in sun), open the windows and allow the hot air to escape before turning on the air conditioner.
- A sensor in the grill provides the air-conditioning system continuously with readings of current outside temperature. So that the air-conditioning can operate at maximum efficiency, the area below the front license plate holder must not be covered. ■

Controls

This overview will help you to familiarize yourself with the air conditioning controls.



Fig. 101 Air conditioning controls

The display shows the temperature selected and the blower setting.

You can set the temperature for the driver's side using the left rotary switch (A) and the temperature for the passenger's side with the right switch (B).

Functions are turned on and off by touching the buttons. The diode in the buttons illuminates when the function is active.

The grille between the buttons (-) / (+) and (AUTO) must remain unobstructed; there are measurement sensors behind it.

- Do not seal off the grille.
- Do not clean the grille with a vacuum cleaner, otherwise the sensors could be damaged.

But-ton(s)	Function	Page
(AC)	Switching the cooling system on/off	⇒ page 97
(AUTO)	Automatic operation	⇒ page 98
(-) (+) (in the center)	Blower speed setting	⇒ page 100
(Icon: car with closed windows)	Manual recirculation mode	⇒ page 99
(Icon: car with open windows and 'AUTO' text)	Automatic recirculation mode	⇒ page 99
(Icon: windshield with snow)	Defrost	⇒ page 98
(Icon: air flow to windows)	Air directed to the windows	⇒ page 100
(Icon: air flow to outlets)	Air from the outlets	⇒ page 100
(Icon: air flow to footwell)	Air directed to the footwell	⇒ page 100
(Icon: rear window with snow)	Rear window defogger	⇒ page 102

The buttons for setting the air flow direction (Icon: air flow to windows), (Icon: air flow to outlets) and (Icon: air flow to footwell) can also be pushed in combination. ■

Applies to vehicles: with automatic air conditioner

Switching the air conditioner on/off (AC)

- Press the (AC) button to switch the air conditioner on or off.

When the air conditioner is switched on, the indicator light in the button is lit.

When the air conditioner is switched off, the cooling system is switched off - the heating and ventilation system is regulated automatically. Switching off the cooling system (compressor) saves fuel. ►

Please keep in mind that with the air conditioner switched off, the interior temperature cannot be lower than the outside temperature. There is no cooling and the air is not dehumidified (danger of the windows becoming fogged).

Tips

If there is a defect in the air conditioner, the air conditioner cannot be switched on. In this case, the diode in the button does not light after being switched on. In the event of a system fault, please contact an Audi or specialist garage. ■

Automatic mode

The automatic mode is the standard setting for all seasons.

Switching on AUTO

- Select temperature between 64 °F (+18 °C) and 84 °F (+28 °C).
- Press  ⇒ page 97, fig. 101.

AUTO only works when you set the inside temperature between 64 °F (18 °C) and 84 °F (28 °C). If you select a temperature below 64 °F (18 °C), **LO** will appear in the display. If you select a temperature above 84 °F (28 °C), **HI** will appear in the display.



The system automatically compensates for changes in outside temperature and for the intensity of the sunlight.

Tips

By keeping the  button on the driver's side pressed for several seconds, the temperature of the passenger's side can be set to the temperature of the driver's side or vice versa. The new temperature setting will be shown in the display. ■

Setting the temperature

Separate temperatures can be selected for the driver's and front passenger's side.

- Turn the rotary switch  on the driver's side and the rotary switch  on the passenger's side left (-) or right (+) to control the temperature ⇒ page 97, fig. 101.

There is a time delay before the selected temperature is reached.

Tips



The temperature setting for the driver's side can be transferred to the passenger's side ⇒ page 98. ■

Defrosting/defogging the windshield

The windshield and side windows are quickly defrosted or defogged

- Press  ⇒ page 97, fig. 101.
- Press  again or press  to switch off the defroster.

The temperature is automatically controlled. Maximum airflow is primarily blown in through outlets ,  and  ⇒ page 101.



Outlets  can be opened and closed with the controls behind them. Outlets  and  must be opened so the windows can be defrosted as quickly as possible.

By pressing  and air recirculation are switched off. ■

Manual air recirculation mode

The recirculation mode prevents polluted outside air from entering the vehicle interior.

Switching on air recirculation

- Press the button  ⇒ page 97, fig. 101 ⇒ .

Switching off air recirculation

- Press the button  again, or
- Press the **AUTO** button, or
- Press the  button.

In air recirculation mode, air is drawn from the vehicle interior and recirculated. We recommend that you use the manual air recirculation mode under the following conditions:

When driving through a tunnel or in a traffic jam so that exhaust fumes cannot enter the vehicle interior.

WARNING

Do not use this setting for extended periods of time. The windows could fog up since no fresh air can enter the vehicle. If the windows fog up, press the air recirculation button again immediately to switch off the air recirculation function or select defrost. ■

Automatic air recirculation

If outside air is polluted, an air quality sensor in the vehicle will automatically switch on the air recirculation.

Switching on air recirculation

- Press  ⇒ page 97, fig. 101.

Switching off air recirculation

- Press  again, or
- press **AUTO**, or
- press .



The automatic air recirculation mode should normally be left switched on at all times.

The system is ready to operate approximately 30 seconds after you turn on the ignition or start the vehicle. Fresh air enters the vehicle only during this initialization period.

The air quality sensor for detecting diesel and gasoline exhaust fumes switches automatically to air recirculation mode if the outside air is heavily polluted. The supply of outside air is closed off.



As soon as the pollution level drops, fresh air is automatically supplied to the vehicle interior again.

The air recirculation operates for a maximum of 12 minutes. If the windows start to fog up while the air recirculation is on, press .

Under certain operating conditions (for example, if  or  are pressed) the air recirculation automatically switches off. If the air conditioner is switched off, or if the temperature is below 18 °F (-8 °C), the air recirculation will operate only for 12 seconds. ■

Switching between Fahrenheit and Centigrade

You can change the temperature display from °F (Fahrenheit) to °C (Centigrade) and vice versa.

- Hold the  button down ⇒ page 97, fig. 101.
- Turn the rotary switch (driver's side)  for 3 seconds +. ■

Air recirculation

The air recirculation prevents exhaust fumes or other pollution from entering the vehicle.

Switching air recirculation on

- Press  ⇒ page 97, fig. 101 ⇒ 

Switching air recirculation off

- Press  again, or
- press **AUTO**, or
- press .

In the air recirculation mode, the air in the passenger compartment is recirculated to prevent exhaust fumes and other pollution from entering the vehicle. We recommend that you use the manual air recirculation under the following conditions:



- when driving through tunnels
- in a traffic jam.

WARNING

Do not use this setting for extended periods of time. The windows could fog up since no fresh air can enter the vehicle. If the windows fog up, press the air recirculation button again immediately to switch off the air recirculation function or select defrost. ■

Adjusting the fan speed



The automatically selected fan speed can be increased or decreased.

- Press the  or  buttons in the center of the control panel ⇒ page 97, fig. 101 to adjust the fan speed to your comfort.

The air conditioning system automatically regulates the fan speed in response to the interior temperature. However, you can also adjust the fan speed manually. A line of small bars in the center display above the fan control buttons will retreat or extend to reflect your adjustments to the fan speed. ■

Air distribution

The automatically controlled air distribution can be changed manually.

You can use the ,  or  buttons separately or together in combination. To switch back to the automatic air distribution setting, either switch off the buttons you previously selected, or press **AUTO**.

Each of the three buttons has its own specific function (the reference numbers refer to the air outlets) ⇒ page 101, fig. 102.

Air directed to the windows

All the air is directed to outlets ①, ② and ③. Contrary to when  is pressed, the amount of air remains the same.

Air directed to the driver/front passenger

All the air is directed to outlets ②, ③ and ④ in the instrument panel. Air also is directed through the center console in the rear. ►

Air directed to the footwells

All the air is directed to outlets ⑤ and to the outlets under the front seats. ■

Air outlets



Fig. 102 Instrument panel: air outlet locations and airflow directions

The air outlets ① and ② on top of the instrument panel are *fixed*. Outlets ③ and ④ *can be adjusted*.

Adjusting air outlets ③ and ④

- Turn the vertical thumbwheel beside the outlet to increase, reduce or shut down the airflow from that outlet.
- Move the small tab in the center of the outlet louver sideways and up or down to adjust the level and direction of airflow.

The supply of air to the outlets is controlled either automatically or manually depending on the operation mode selected. The airflow from all outlets can be heated, unheated or cooled.

The heater outlets for the rear footwells are located under the front seats. When you select outlets ⑤, air is also directed to the rear footwells.

Tips

- When defrosting/defogging the windows, air flows from outlets ①, ② and ③. To defrost or defog the windows as rapidly as possible, air outlets ③ should be opened *fully* with the adjuster wheels.
- When the air conditioner is working, cooled air will flow primarily from outlets ②, ③ and ④. To assure adequate cooling, outlets ③ and ④ should never be completely closed. ■

Using the climate controls economically

Using the climate controls prudently can help save fuel.

When you use the air conditioner, engine power is reduced and fuel consumption increases. To save fuel, you should use the air conditioner only when necessary. Also please note the following points:

- If you want to save fuel, switch off the air conditioner.
- If you are going to drive with the windows open, switch off the air conditioner.

For the sake of the environment

By reducing the amount of fuel you use, you also reduce the amount of pollutants emitted into the air. ■

Key coded settings

When the ignition is switched on, the air conditioner settings are automatically assigned to the key being used.

The air conditioner settings selected are automatically stored and assigned to the key being used. When the vehicle is started, the air conditioner automatically selects the settings assigned to that key. This way every driver will maintain his/her own personal settings and does not have to reset them manually.

Tips

If a different driver uses your key and changes the air conditioner settings, the latest adjustments will erase and replace the settings you have stored. ■

Rear window defogger

The rear window defogger clears the rear window of condensation.



Fig. 103 Switch for rear window defogger with air-conditioning

- Press the  switch to switch the rear window defogger on and off.

The defogger works only with the engine running. When the defogger is switched on, an indicator light in the switch comes on.

The rear window defogger switches off automatically after about 20 minutes.



For the sake of the environment

Turn the defogger off when the rear window is clear. When you save electricity, you save fuel. ■

Applies to vehicles: with diesel engine

Additional heater

- Switch the **Additional heater** to **AUTO**.

Vehicles with diesel engines are equipped with an additional heater to warm the interior of the vehicle more quickly. The additional heater switches itself on and off automatically when the outside temperature is below 50 °F (10 °C) and the engine is running, depending on the coolant temperature, interior temperature and the selected temperature. ■

Applies to vehicles: with electrically heated front seats

Electrically heated front seats

With the ignition on, the seat cushion and backrest of the front seats can be heated.



Fig. 104 Center console: thumbwheels for front seat heating

Use the thumbwheels in the center console ⇒ fig. 104 to turn on and adjust front seat heating. An infinite range of positions are possible.

- Roll the thumbwheel ① (driver's seat) or ② (front passenger's seat) from position (0) upward in order to activate the heating elements.
- Select the desired temperature setting from positions 1 through 6.

When the heating element is activated, the numbers on the thumbwheel will illuminate.

! Note

To prevent possible damage to the heating elements, do not kneel on the seats or apply a heavy load to relatively small areas of the seat. ■

Applies to vehicles: with engine preheater

Engine preheater

Use of the engine preheater is recommended when the ambient temperature is below $-5\text{ }^{\circ}\text{F}$ ($-20\text{ }^{\circ}\text{C}$).

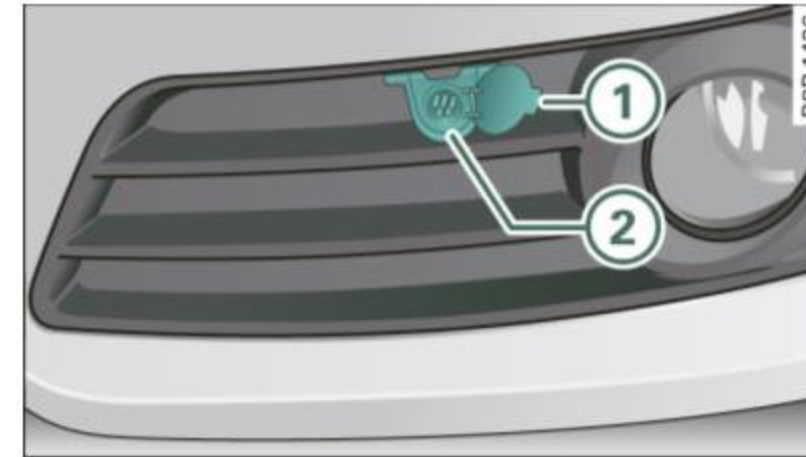

Fig. 105 In the left front bumper: engine preheater connection socket

The engine preheater slowly warms the engine coolant using a heating element when the vehicle is parked. The included cable⁴⁾ must be connected to a 120 Volt Ground Fault Circuit (GFI) protected outlet that is protected from water (in your garage, for instance). When the coolant is preheated, the engine reaches its operating temperature more quickly and will use less fuel and produce fewer polluting emissions during the warm-up phase.

Preheating the engine can take up to 3 hours depending on the temperature outside.

Connecting the engine preheater

- Only use the cable provided.
- All cables and connectors that are used must not be damaged ⇒ ⚠.
- Open the cover ⇒ fig. 105 ①.
- Plug the connecting cable into the socket ② ⇒ ⚠.

⁴⁾ The cable is delivered with vehicles in Canada as standard equipment. The cable can be obtained from an authorized Audi dealer for vehicles in the USA.

- Connect the connecting cable to the power cord.
- Attach the extensions cord to the connector cable. Always use a 12 gauge or heavier heavy-duty extension cord that can be properly grounded to a three-prong Ground Fault Circuit (GFI) wall outlet and is not longer than 100 ft (30 meters).
- Always plug the preheater into an 120 Volt Ground Fault Circuit (GFI) wall outlet that is properly protected against rain and other moisture. Never plug the preheater into a normal outlet regardless of whether it is grounded or not.
- Always disconnect the connecting cable and close the cover ⇒ *page 103*, fig. 105 ① before starting the engine.

WARNING

Using incorrect or damaged outlet and power cords, using electrical accessories incorrectly or ignoring safety precautions can lead to short circuits, accidents, injuries and life-threatening electric shocks.

- Always plug the preheater into a 120 Volt Ground Fault Circuit (GFI) wall outlet that is properly protected against rain and other moisture.
- Always check the fuse protection of the 120 Volt power source before using the connecting cable.
- Always use a 12 gauge or heavier heavy-duty extension cord that can be properly grounded to a three-prong GFI outlet. The extension cord must not be longer than 100 ft (30 meters).
- Always connect the cable to a 120 Volt outlet that is grounded and protected from water.
- Check the cable for damage before every use. Never use a damaged cable. It must be replaced. Please see your authorized Audi dealer.
- Only use the cable provided*.
- Always remove the connecting cable before starting the engine.

WARNING (continued)

- **Never attempt to alter or repair electrical components. ■**

On the road

Steering

Adjustable steering wheel

The height and reach of the steering wheel can be adjusted.

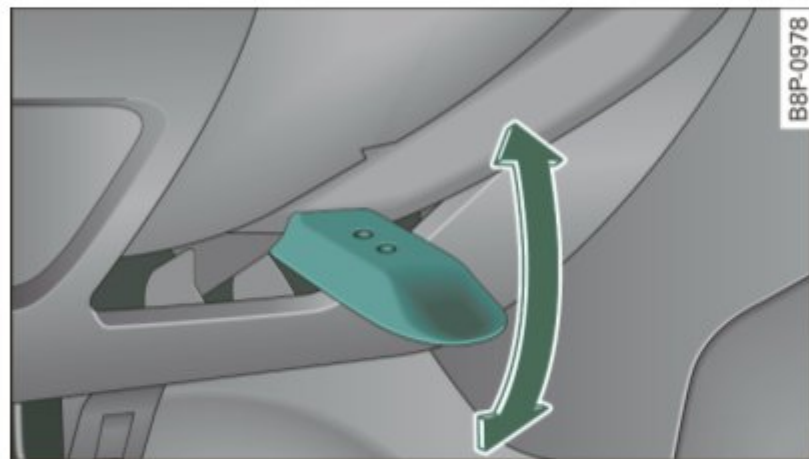

Fig. 106 Lever under the steering column

First, adjust the driver's seat correctly.

- Push the lever ⇒ fig. 106 down as far as it will go ⇒ ⚠.
- Move the steering wheel to the desired position.
- Push the lever back up as far as it will go.

There must be at least 10 inches (25 cm) between your chest and the center of the steering wheel. If you cannot sit more than 10 inches (25 cm) from the steering wheel, see if adaptive equipment is available to help you reach the pedals and increase the distance from the steering wheel.

For detailed information on how to adjust the driver's seat, see ⇒ page 76, "Power seat adjustment".

The steering wheel can be adjusted even when the ignition is turned off.

⚠ WARNING

Improper use of steering wheel adjustment and improper seating position can cause serious personal injury.

- Adjust the steering wheel column only when the vehicle is not moving to prevent loss of vehicle control.
- Always make sure that the adjustment lever is securely pushed up so that the position of the steering wheel cannot be changed unintentionally when the vehicle is moving.
- Adjust the driver's seat or steering wheel so that there is a minimum of 10 inches (25 cm) between your breastbone and the steering wheel ⇒ page 126, fig. 122. If you cannot maintain this minimum distance, the airbag system cannot protect you properly.
- If physical limitations prevent you from sitting 10 inches (25 cm) or more from the steering wheel, check with your authorized Audi dealer to see if adaptive equipment is available.
- Pointing the steering wheel toward your face decreases the ability of the supplemental driver's airbag to protect you in an accident. Always make sure that the steering wheel is pointed towards your chest.
- Always hold the steering wheel on the outside of the steering wheel rim with your hands at the 9 o'clock and 3 o'clock positions to help reduce the risk of personal injury if the driver's airbag inflates.
- Never hold the steering wheel at the 12 o'clock position or with your hands at other positions inside the steering wheel rim or on the steering wheel hub. Holding the steering wheel the wrong way can cause serious injuries to the hands, arms and head if the driver's airbag inflates. ■

Ignition lock and ignition switch

Ignition lock

The engine can be started or turned off with the ignition key.

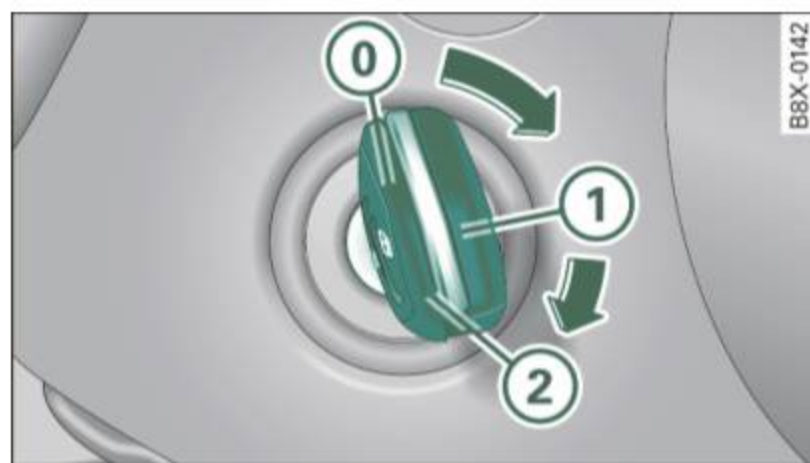

Fig. 107 Ignition lock positions

Ignition off ①

In position ⇒ fig. 107 ① both the ignition and engine are off, and the steering is locked.

To **lock the steering** after you have removed the ignition key, turn the steering wheel in either direction until you hear it lock into place. You should always lock the steering whenever you leave your vehicle. This makes a vehicle theft even more difficult ⇒ ⚠.

Ignition on ②

If it is difficult to turn the key after you have inserted it into the ignition lock, turn the steering wheel back and forth. This will take the load off the steering lock mechanism and you will be able to turn the key freely and start the engine. On vehicles with a diesel engine*, the system can preheat in this position.

Starting the engine ③

In this position the engine starts. While the engine is starting, the power supply to the headlights and other electrical consumers is

temporarily interrupted to conserve battery power. After the engine has started, release the key and it will return to position ①.

Before the starter can be operated again the key must be turned back to position ①. The **non-repeat lock** prevents you from damaging the starter when the engine is running.

⚠ WARNING

- Never remove the key from the ignition lock while the vehicle is moving. The steering wheel will lock causing loss of control.
- If you have to leave your vehicle – even for just a minute – always remove the ignition key and take it with you. This is especially important if you are going to leave children behind in the vehicle. The children could start the engine or use other vehicle controls. Unsupervised use of vehicle controls (for example, power windows) can cause serious personal injuries.

i Tips

If the vehicle battery has been disconnected and then reconnected, then you must leave the key in position ① for about 5 seconds before you can start the engine. ■

Applies to vehicles: with automatic transmission

Ignition key safety lock

The ignition key can only be removed when the selector lever is in the “P” (Park) position.

Place the selector lever in the “P” position before switching off the engine.

After switching off the ignition, the ignition key can only be removed from the ignition lock when the selector lever is in the “P” (Park) position. After you have removed the key, the selector lever is locked and cannot be moved. ■

Starting and stopping the engine

Starting the engine

The engine can only be started with your original Audi key.

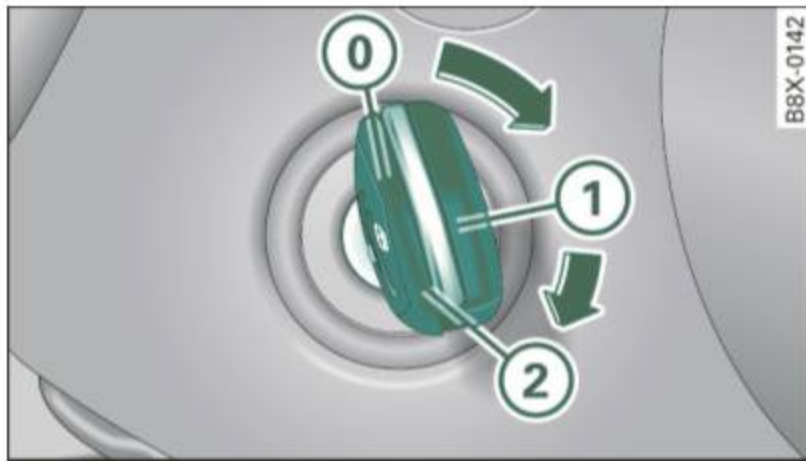

Fig. 108 Ignition key positions

Vehicles with a gasoline engine:

- Move the selector lever to the neutral position (automatic transmission): selector lever in P or N) ⇒ ⚠.
- On vehicles with manual transmission, fully depress the clutch pedal.
- Turn the ignition key to position ② ⇒ page 106, fig. 107 - do not depress the gas pedal when starting the engine!
- Let go of the key as soon as the engine starts.

Vehicles with a diesel engine:

- Set the parking brake.
- Move the selector lever to the neutral position (automatic transmission): selector lever in P or N) ⇒ ⚠.

- On vehicles with manual transmission, fully depress the clutch pedal.
- Turn the ignition key to position ① ⇒ fig. 108. The glow plug warning light ⚠ lights up while the glow plugs are warming up.
- When the warning light goes out, turn the ignition key to position ② to start the engine ② ⇒ page 106, fig. 107. Do not depress the gas pedal when starting the engine!
- Let go of the key as soon as the engine starts.

A cold engine may sound loud after it has been started. This is due to the hydraulic valves building up oil pressure. This is normal and is not a need for concern.

If the engine does not start immediately, stop trying after 10 seconds and then try to restart the engine about 30 seconds later.

Glow plug system*

Diesel engines are equipped with a glow plug system whose preheating time is controlled by the coolant and outside temperature. Start the engine *immediately* after the glow plug indicator light ⚠ switches off.

The glow plug indicator light will only illuminate for approximately 1 second when the engine is warm or the outside temperature is higher than 46 °F (8 °C). That means you can start the engine *immediately*.

To start the diesel engine after the fuel tank has been run dry

If the fuel tank was run completely dry, the starting process after refueling with diesel fuel can take longer than usual – up to one minute. This is because the fuel system first has to be vented of air while starting. ▶

WARNING

Never start or let the engine run in a confined or enclosed area. Exhaust fumes from the engine contain carbon monoxide, a colorless and odorless gas. Carbon monoxide can be fatal if inhaled.

- Never leave the engine idling unattended. An unattended vehicle with a running engine poses a danger of personal injury or theft.

Note

- Avoid high engine speeds, fast acceleration or heavy engine loads while the engine is still cold. This could damage the engine.
- The engine cannot be started by pushing or towing the vehicle.

For the sake of the environment

To avoid unnecessary engine wear and to reduce exhaust emissions, do not let your vehicle stand and warm up. Be ready to drive off immediately after starting your vehicle. Maintain moderate speed until the engine is completely warm. Remember, the engine performs best at operating temperature. ■

Stopping the engine

- Turn the ignition key to position  ⇒ page 106, fig. 107.

WARNING

- Never turn off the engine until the vehicle has come to a complete stop.
- The brake booster and servotronic only work when the engine is running. With the ignition turned off, you have to apply more force when steering or braking. Since you cannot steer and stop normally, this can lead to accidents and serious injuries.

WARNING (continued)

- The radiator fan can continue to run for up to 10 minutes even after you have turned off the engine and removed the ignition key. The radiator fan can also turn on again if the engine coolant heats up because of intense sunlight or heat build-up in the engine compartment.

Note

Do not stop the engine immediately after hard or extended driving. Keep the engine running for approximately two minutes to prevent excessive heat build-up. ■

Parking brake

Parking brake

When the parking brake is set, it prevents the vehicle from rolling away unintentionally.

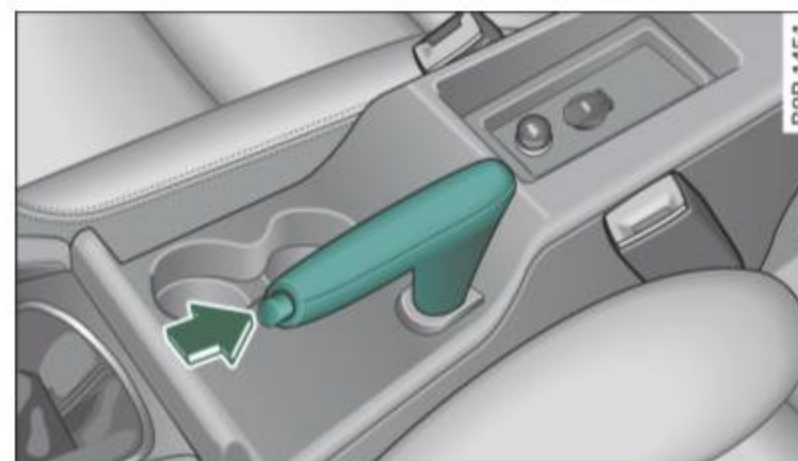



Fig. 109 Center console: Parking brake set

Setting the parking brake

- Pull the parking brake lever all the way up. 

Releasing the parking brake

- Pull the parking brake lever up slightly *and* press the release button at the same time ⇒ *page 108, fig. 109 -arrow-*.
- Keep the release button pressed and lower the parking brake ⇒ .

If you should drive off with the parking brake still set, a warning tone will sound and the following will appear in the instrument cluster to remind you to release the parking brake:

Parking brake set

The parking brake warning comes on only after you have driven for longer than 3 seconds and faster than 5 mph (5 km/h).

The parking brake warning light **Brake** (USA)/  (CDN) illuminates when the parking brake is set and you switch on the ignition.

WARNING

Always release the parking brake completely. A partially engaged brake will overheat the rear brakes, reduce their effectiveness and cause excessive wear. This could lead to brake failure and an accident.

Note

Only after the vehicle has come to complete stop, should you firmly set the parking brake and either move the gearshift lever into 1st. gear (manual transmission) or move the selector lever into "P" (Automatic transmission). ■

Parking

To prevent a parked vehicle from rolling away, there are a few things you should do.

When you park your vehicle, do the following:

- Stop the vehicle using the brake pedal.
- Set the parking brake firmly.
- Move the selector lever into the **P** position (**automatic transmission**) or move the gearshift lever into 1st. gear (**manual transmission**) ⇒ .
- Switch off the engine and remove the ignition key from the ignition lock.

What else you should do when parking your vehicle on an incline or decline

Turn the steering wheel so that if the vehicle should start to roll, it will roll into the curb.

If you are parking on a **decline** (the front of your vehicle facing downhill), turn the front wheels to the right so that they point *toward the curb*.

If you are parking on an **incline** (the front of your vehicle facing uphill), turn the front wheels to the left so that they point *away from the curb*.

Move the selector lever into the **P** position (**automatic transmission**) or move the gearshift lever into 1st. gear (**manual transmission**).

WARNING

This is how you can reduce the risk of injury when leaving your vehicle.

- **Never park the vehicle where it can come in contact with dry grass, spilled fuel or any other flammable materials.**

⚠ WARNING (continued)

- Never allow anyone - especially small children - to remain in the vehicle when it is locked. Locked doors make it more difficult for rescuers to access the passenger compartment in the event of an emergency. Danger to life!
- Never leave children unsupervised in the vehicle. Children could release the parking brake or move the gearshift lever out of gear. The vehicle could start to roll away and cause an accident.
- No matter what the season is, the temperature in a parked vehicle can reach dangerous levels. ■

Applies to vehicles: with hill hold assist

Starting on hills

Hill hold assist makes it easier to start on hills.

The system is activated when the brake pedal is depressed **for a few seconds**.

After releasing the brake pedal, the brake power is held for a *brief moment* to prevent the vehicle from rolling back when starting. At this time, you can easily begin to move your vehicle.

⚠ WARNING

- If you did not begin moving immediately after releasing the brake pedal, under certain circumstances, the vehicle would begin to roll backward. Depress the brake pedal immediately or engage the hand brake.
- Should the engine stall, depress the brake pedal immediately or engage the hand brake.
- In order to prevent the vehicle from rolling back unintentionally when starting in stop-and-go traffic, keep the brake pedal depressed for a few seconds before driving off.

i Tips

You can find out if your vehicle is equipped with “Hill hold assist” at an authorized Audi dealership. ■

Cruise control

Switching the system on

The cruise control system makes it possible to drive at a constant speed starting at 20 mph (30 km/h).

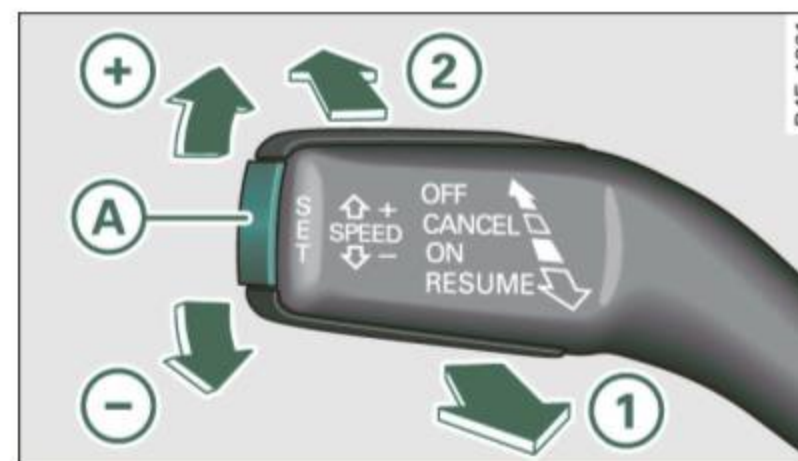



Fig. 110 Control lever with set button



Fig. 111 Display: Selected speed

- Pull the lever to position ① ⇒ fig. 110 to switch the system on.

- Drive at the speed you wish to set.
- Press button **A** to set that speed.

The display ⇒ *page 110*, fig. 111 will show the set speed. The display may vary depending on the type of display in your vehicle. The indicator light **CRUISE** (US model) /  (Canadian model) will also light up in the instrument cluster.

WARNING

- **Always pay attention to traffic even when the cruise control is switched on. You are always responsible for your speed and the distance between your vehicle and other vehicles.**
- **For safety reasons, the cruise control should not be used in the city, in stop-and-go traffic, on twisting roads and when road conditions are poor (such as ice, fog, gravel, heavy rain and hydroplaning) - risk of accident.**
- **Turn off the cruise control temporarily when entering turn lanes, highway exit lanes or in construction zones.**
- **Please note that inadvertently “resting” your foot on the accelerator pedal causes the cruise control not to brake. This is because the cruise control is overridden by the driver's acceleration.**

Tips

- Vehicles with manual transmission: You can attain the set speed only if the currently engaged gear allows it and the engine is not stressed. Shifting to a higher or lower gear promptly will allow the engine to run smoothly.
- The cruise control cannot maintain a constant speed when driving downhill. The vehicle will accelerate under its own weight. Downshift to a lower gear or use the brakes to slow down. ■

Changing speed

- Press lever in the **+** or **-** direction ⇒ *page 110*, fig. 110 to increase or decrease your speed.
- Release the lever to save that speed.

Change speed in increments of 1 mph (1 km/h) by lightly pressing the lever. If you keep the lever pressed down, you will alter your speed in 5 mph (10 km/h) increments.

You can also press the accelerator pedal down to increase your speed, e.g. if you want to pass someone. The speed you saved earlier will resume as soon as you release the accelerator pedal.

If, however, you exceed your saved speed by 5 mph (10 km/h) for longer than 5 minutes, the cruise control will turn off temporarily. The symbol will go out but the saved speed will be retained. ■

Presetting your speed

You can preset your desired speed while the vehicle is not moving.

- Turn on the ignition.
- Pull lever into position **1** ⇒ *page 110*, fig. 110.
- Press the lever in the **+** or **-** direction to increase or decrease your speed.
- Release the lever to save that speed.

This function makes it possible, for example, to save the speed you want before driving on the highway. Once on the highway, activate the cruise control by pulling the lever toward **1**. ■

Switching the system off

Temporary deactivation

- Press the brake pedal, or
- Keep the clutch pedal pressed down *longer*, or
- Press the lever into position ② (not clicked into place) ⇒ *page 110, fig. 110*, or
- Drive for longer than 5 minutes at more than 5 mph (10 km/h) above the stored speed.

Switching off completely

- Press lever into position ② (clicked into place), or
- Switch the ignition off.

The system retains the saved speed if you deactivate the cruise control temporarily. To resume the saved speed, release the brake or clutch pedal and pull the lever to position ①.

Switching the ignition off erases the saved speed.

WARNING

You should only return to the saved speed if it is not too fast for the current traffic conditions - risk of an accident! ■

Applies to vehicles: with magnetic ride

Audi magnetic ride

Damping can be adjusted to the driver's preference and it adapts automatically to the current driving situation.



Fig. 112 Center console: Switch for Audi magnetic ride

- Press the switch ⇒ fig. 112 to turn sport setting on or off.

Audi magnetic ride is an electronically controlled damping system. This chassis system assists the driver by adapting to the particular situation through imperceptible control processes. The **damping** provides individual modulation of damping forces. For example, with damping characteristics set to provide greater comfort, damping is set somewhat harder for a brief period only as required, when rounding a curve and when braking.

Standard setting

Select the standard setting if you prefer a suspension setting emphasizing comfort.

Sport setting

Select the sport setting if you prefer a sporty suspension setting. The LED in the switch  comes on to indicate sport setting. ►

 **Tips**

The warning/indicator light  in the instrument cluster comes on in the event of a malfunction. Drive to the closest authorized Audi dealer as soon as possible and have the malfunction repaired. ■

Transmission

Manual transmission

Applies to vehicles: with manual transmission

Gearshift lever

The clutch pedal must be depressed all the way before you can start the engine.

The manual transmission in your Audi is equipped with an *interlock-feature*.

- Depress the clutch pedal all the way.
- Start the engine with the gearshift lever in Neutral and the clutch pedal depressed.

Note

Always depress the clutch pedal fully when changing gears. Do not hold the vehicle on a hill with the clutch pedal partially depressed. This may cause premature clutch wear or damage.

Tips

- Resting your hand on the gearshift lever knob while driving will cause premature wear in the transmission.
- The back-up lights go on when you shift into Reverse with the ignition on. ■

Applies to vehicles: with 6-speed manual transmission

Gearshift pattern (6-speed manual transmission)

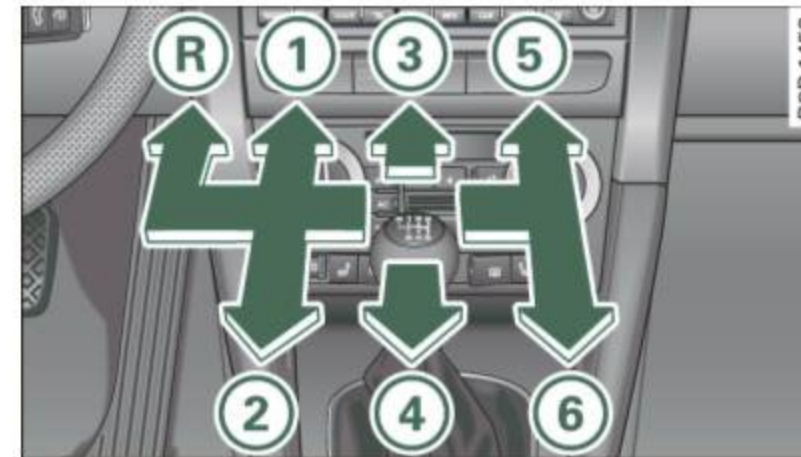

Fig. 113 Gearshift pattern: 6-speed manual transmission

Drive in 6th gear for optimum fuel economy when cruising. However, if more acceleration is required (when passing, for example), shift down.

Engaging reverse gear (R)

- Move the shift lever all the way to the left, press it down, then push it forward.

Especially after driving forward, stop the vehicle completely, shift into *Neutral* and rest the shift lever briefly in *Neutral* before shifting into *Reverse*. ■

S tronic transmission

Applies to vehicles: with S tronic®

Introduction

Your vehicle is equipped with a S tronic transmission, also called a double-clutch system/transmission.

Power is transferred between the engine and the transmission by means of two independent clutches. They replace the torque converter of conventional automatic transmissions and allow the vehicle to accelerate without a noticeable break in the power flow.

With the aid of **tiptronic**, the gears can optionally be shifted *manually* ⇒ page 119. ■

Applies to vehicles: with S tronic®

Selector lever positions

All the selector lever positions are explained in this section.



Fig. 114 Display: Selector lever positions

The instrument cluster display shows the selector lever position.

P - Park lock

In this position the gears are mechanically locked.

The park lock must only be engaged with the vehicle *stationary* ⇒ ⚠.

To engage P and to remove the lever from this position, you must depress the release button (button in the selector lever handle) *and* simultaneously you must step on the brake pedal.

R - reverse

In this position, reverse is engaged.

Reverse gear must only be engaged with the vehicle *stationary* and the engine running at idle speed ⇒ ⚠.

To engage R, you have to depress the release button *and* simultaneously step on the brake pedal. In the R position, the back-up lights illuminate with the ignition on.

N - Neutral

The transmission is in neutral in this position.

D - Normal position for driving forward

In this position, the forward gears are automatically shifted up and down, depending on engine load and vehicle speed.

To engage S from N, the brake pedal must be depressed at speeds below 5 km/h or when the vehicle is stationary ⇒ ⚠.

In certain circumstances (driving in the mountains for example) it can be beneficial to switch temporarily to the manual shift program ⇒ page 119 in order to adjust the gear ratios to driving conditions *manually*.

S - Sport setting

The S setting should be selected for sporting driving. The power reserves of the engine can be fully exploited through later upshifts.

To engage S from N, the brake pedal must be depressed at speeds below 5 km/h or when the vehicle is stationary ⇒ ⚠. ▶

WARNING

- Never place the selector lever in the R or P position while the vehicle is moving - risk of an accident!
- With the engine running, it is necessary to hold the vehicle with the foot brake in all selector lever positions (except P and N), because even at idle speed the transfer of power is never completely interrupted - the vehicle “creeps”. If the vehicle is stationary and the transmission is engaged, the engine should never be speeded up unintentionally (e.g. manually from under the hood). Otherwise the vehicle will immediately start to move - sometimes even if the parking brake is firmly applied - risk of an accident!
- Before you or other persons open the hood and work on a running engine, the selector lever must be moved to P and the parking brake applied firmly - risk of an accident! Follow the warning stickers ⇒ *page 218*, “Engine compartment”.

Tips

If you have inadvertently shifting into N while the vehicle is moving, you should remove your foot from the accelerator and wait until the engine speed has dropped to idle before shifting back to D or S. ■

Applies to vehicles: with S tronic®

Selector lever lock

The selector lever lock prevents a gear from being engaged accidentally and unintentionally setting the vehicle in motion.



Fig. 115 Selector lever locks

The selector lever lock is released as follows:

- Switch the ignition on.
- Step on the brake pedal *and* simultaneously hold down the release button.

Automatic selector lever lock

The selector lever is locked in the P and N positions when the ignition is on. To move the lever from these positions the driver must depress the brake pedal. As a reminder to the driver, the following warning appears in the instrument cluster display when the selector is in P and N:

APPLY BRAKE WHEN ENGAGING GEAR WITH VEHICLE STATIONARY

In addition, the symbol  for the automatic selector lever lock illuminates in the shift gate. ▶

The selector lever lock is effective only when the vehicle is stationary and at speeds below 5 km/h. At higher speeds, the lock in the N position is automatically switched off.

The selector lever is not locked when rapid shifts are made through the N position (e.g. from R to D). This allows you to “rock” the vehicle if it becomes stuck. If the lever is in the N position for more than 1 second with the brake pedal not depressed, the selector lock engages automatically.

Release button

The release button in the selector lever handle prevents accidental shifts into certain selector lever positions. When you press the release button, the selector lever lock is cancelled. In the illustration, the positions in which the release button has to be pressed are highlighted in color ⇒ *page 116, fig. 115*.

Ignition key removal lock

The ignition key can only be removed after the ignition is switched off if the selector lever is in P. As long as the ignition key is removed, the selector lever is locked in P.

Tips

If the selector lever does not engage, there is a malfunction. The engine is disabled to prevent the vehicle from driving off unintentionally. To allow the selector lever to engage again, proceed as follows: Press and release the brake pedal. ■

Applies to vehicles: with S tronic®

Driving Notes

The forward gears are shifted up or down automatically.



Fig. 116 Section from center console: Selector lever with release button

Starting from stop

- Step on and hold the brake pedal.
- Hold the release button (button in selector lever) down, move the selector lever to the desired position, for example D ⇒ *page 115*, and release the button.
- Release the brake pedal and accelerate ⇒ .

Stopping temporarily

- Bring the vehicle to a full stop with the brake, e.g. at traffic signals.
- Do not accelerate.

Parking

- Step on and hold the brake pedal ⇒ .
- Apply the parking brake firmly.
- Hold the release button down, move the selector lever to P and release the button. ►

Stopping on an incline

- Always hold the vehicle with the footbrake or parking brake in order to prevent “rollback” ⇒ . Do **not** try to prevent the vehicle from rolling back by revving the engine while it is in gear.

Starting on a hill

- Apply the hand brake firmly.
- With the engine in gear, gradually accelerate and release the hand brake.

The engine can only be **started** with the selector lever in P or N ⇒ *page 107*. At low ambient temperatures (14 °F /-10 °C), it is only possible to start the engine with the selector lever in P.

When parking on level ground, it is sufficient to place the selector lever in P. On a steeply sloping road, you should first apply the parking brake firmly and then place the selector lever in P. This way, you do not overload the pawl mechanism and it is easier to move the selector lever out of P.

WARNING

- **Never leave your vehicle with the engine running while in gear. If you must leave your vehicle with the engine running, set the parking brake and engage the park lock.**
- **When the engine is running and the transmission is in gear (D, S or R) or in “tiptronic” mode, it is essential that you stop the vehicle with the footbrake. When idling, the transmission of power does not stop completely – the vehicle “creeps”.**
- **Do not accelerate when you change the selector lever position with the vehicle stationary and the engine running - risk of an accident!**
- **Never place the selector lever in the R or N position while the vehicle is moving - risk of an accident!**

WARNING (continued)

- **If you have to bring your vehicle to a stop while on an incline, keep the foot brake depressed all the way down so that the vehicle does not start to roll backward. You should never hold the vehicle using the clutch if you are going to be stopped on an incline. If you do, the clutch will start to slip when it overheats caused by the constant overload. This is dangerous because if the vehicle starts to roll backward, you could cause an accident. If the clutch should start to slip, you will feel the vehicle "jerk" and the selector lever display will start blinking.**
- **Before driving down a steep slope, reduce your speed and shift into a lower gear with “tiptronic”.**
- **Do not ride the brakes or apply the brake pedal too often or too long. Constant braking causes the brakes to overheat and substantially reduces braking performance, increases braking distance or causes complete failure of the brake system. ■**

Applies to vehicles: with S tronic transmission and Hill Descent Assist

Hill Descent Assist

Hill Descent Assist helps the driver when driving down inclines.

Hill Descent Assist is activated by pressing the brake while descending when the selector lever is in **D/S**. The S tronic transmission automatically shifts down to a gear suitable for the incline. Hill Descent Assist attempts to maintain the current vehicle speed when the braking occurs, as far as physical and technical limits allow. It may be necessary to adjust the speed using the brakes.

Hill Descent Assist switches off when the incline levels out or when the gas pedal is pressed.

On vehicles with cruise control* ⇒ *page 110*, Hill Descent Assist is also activated when the speed is set. 

WARNING

Hill Descent Assist cannot overcome physical limitations, so it may not be possible to maintain a constant vehicle speed under all circumstances. Always be ready to apply the brakes. ■

Applies to vehicles: with S tronic®

tiptronic operation

Tiptronic allows the driver to shift gears manually.



Fig. 117 Center console: Manual shifting (tiptronic)



Fig. 118 Display: Manual shifting (tiptronic)

Switching to manual

- Push the selector lever to the right from D. As the transmission has switched, **6 5 4 3 2 1** appears in the display, with the gear that is engaged highlighted.

Upshifting

- Tap the selector lever forward (in the tiptronic setting) ⇒ fig. 117 .

Downshifting

- Tap the selector lever backward (in the tiptronic setting) .

Switching to manual can be carried out with the vehicle stationary as well as moving.

When accelerating, the transmission shifts into the next gear in gears 1, 2, 3, 4 and 5 shortly before the maximum permissible engine speed is reached.

If you have selected a lower gear than the current one, the transmission will only shift down when the engine cannot be overspeeded.

If kick-down is actuated, the transmission shifts into a lower gear independently of speed and engine rpm. ■

Applies to vehicles: with S tronic® and with Tiptronic controls on the steering wheel

Steering wheel with Tiptronic® controls

The selector paddles allow the driver to keep both hands on the steering wheel when shifting gears.



Fig. 119 Sport steering wheel with selector paddles

Shifting up

- Pull the *right* paddle, marked (+) ⇒ fig. 119 briefly towards you.

Shifting down

- Pull the *left* paddle, marked (-) ⇒ fig. 119 briefly towards you.

The selector paddles on the steering wheel are activated when the selector lever on the center console is in **D**, **S**, or in the manual position (Tiptronic mode).

You can also shift gears in the Tiptronic mode using the selector lever on the center console.

Tips

With the gear selector lever in either “D” or “S” the transmission will switch back to the automatic mode if you do not use the paddles within approx. 30 seconds. ■

Applies to vehicles: with S tronic®

Kick-down feature

The kick-down feature allows maximum acceleration.

If you depress the accelerator pedal fully beyond the full-throttle position, the transmission automatically downshifts one gear, depending on vehicle speed and engine rpm. The upshift into the next higher gear takes place as soon as the maximum specified engine speed is reached.

WARNING

Please note that the drive wheels can spin if the kick-down is used on a smooth slippery road - risk of skidding! ■

Applies to vehicles: with Launch Control and S tronic® and Gasoline engine only

Launch Control Program

The Launch Control Program permits maximum acceleration.

In order to use Launch Control, the ASR (Anti-Slip Regulation) must be disabled. When ASR is disabled, the ESP warning/indicator light  in the instrument cluster illuminates. So that Launch Control can be used, the engine must be at operating temperature and the steering wheel must not be turned.

- With the engine running, briefly press the ESP button. The message “ASR off” appears in the instrument cluster display.
- Shift the gear lever to “S” or the tiptronic® position.
- Step on the brake pedal with your left foot and keep the brake pedal fully depressed for at least one second. ▶

- With your right foot, step on the accelerator to the wide-open throttle position or Kickdown. The engine speed settles at about **3,200 rpm**.
- Take your left foot off the brake.

WARNING

- Always adapt your driving to the traffic flow.
- Only use Launch Control when road and traffic conditions allow it and other drivers will not be endangered or annoyed by your driving and the acceleration of the vehicle.
- Make sure that ESP remains enabled. With the ESP disabled, the vehicle could brake away, particularly on a slick and slippery road - risk of skidding!
- Once acceleration is finished, switch ASR on again by briefly pushing the ESP button. ■

Applies to vehicles: with S tronic®

Back-up program

In the event of a system malfunction, there is an back-up program.

In the event of system malfunction, the automatic transmission switches to the fail-safe mode. All of the selector lever position displays for the automatic transmission are highlighted with a light background in the instrument cluster display. In some cases you cannot drive in the reverse gear any more.

If the transmission switches to fail-safe mode, you should take the vehicle to an authorized Audi dealership as soon as possible to have the condition corrected. ■

Applies to vehicles: with S tronic®

Emergency release for selector lever

If the vehicle's power supply fails, the selector lever can be released in an emergency.

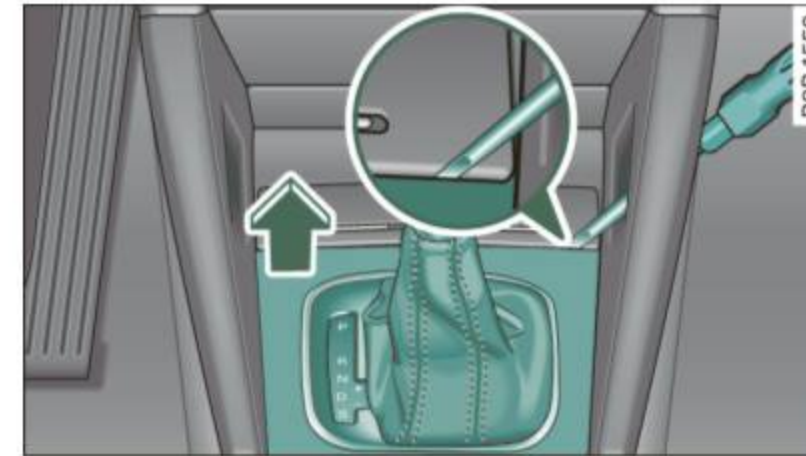

Fig. 120 Selector lever: Remove selector lever sleeve

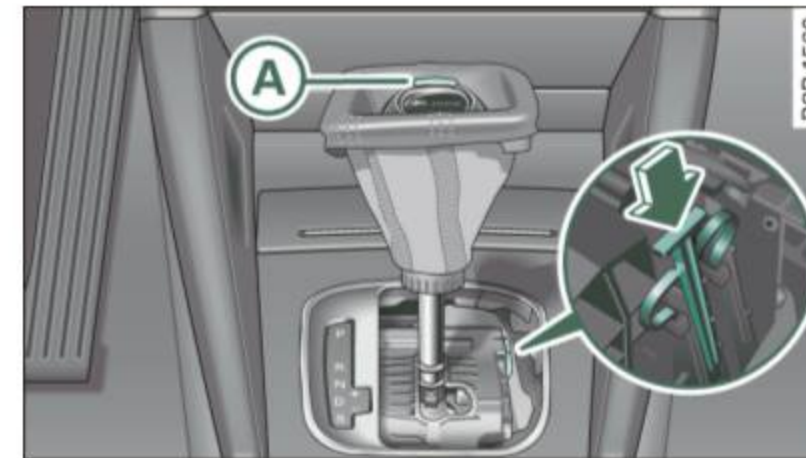

Fig. 121 Selector lever: emergency release from the Park position

The emergency release mechanism is located on the right front under the selector lever shift gate. The release procedure requires professional dexterity. We recommend that you seek assistance.

Removing the selector lever boot

- Engage the parking brake. ▶

- Remove the screwdriver from the vehicle tool kit. Use the flat side of the reversible screwdriver blade ⇒ *page 270*.
- Carefully pry the cover out with the screwdriver and pull it ⇒ *page 121*, fig. 120 toward the shifter knob in the direction of the arrow. The screwdriver must grip at the lower edge of the cover to loosen it.

Emergency release for selector lever

- Press the yellow release lever in the direction of the arrow ⇒ *page 121*, fig. 121 and hold it in that position.
- Press the release button in the selector lever  and move the lever into the N position.
- Clip the shift boot back into the shift gate.

If the vehicle has to be pushed or towed if the power supply fails (e.g. battery is discharged), the selector lever must be moved to the N position using the emergency locking device.

WARNING

The selector must only be shifted from the P position if the hand-brake is firmly applied. Otherwise the vehicle would start moving unexpectedly on a grade when the selector lever is shifted from the P position - increasing the risk of an accident. ■

Driving Safely

General notes

Safe driving habits

Please remember - safety first!

This chapter contains important information, tips, instructions and warnings that you need to read and observe for your own safety, the safety of your passengers and others. We have summarized here what you need to know about safety belts, airbags, child restraints as well as child safety. Your safety is for us *priority number 1*. Always observe the information and warnings in this section - for your own safety as well as that of your passengers.

The information in this section applies to all model versions of your vehicle. Some of the features described in this sections may be standard equipment on some models, or may be optional equipment on others. If you are not sure, ask your authorized Audi dealer.

WARNING

- Always make sure that you follow the instructions and heed the WARNINGS in this Manual. It is in your interest and in the interest of your passengers.
- Always keep the complete Owner's Literature in your Audi when you lend or sell your vehicle so that this important information will always be available to the driver and passengers.
- Always keep the Owner's literature handy so that you can find it easily if you have questions. ■

Safety equipment

The safety features are part of the occupant restraint system and work together to help reduce the risk of injury in a wide variety of accident situations.

Your safety and the safety of your passengers should not be left to chance. Advances in technology have made a variety of features available to help reduce the risk of injury in an accident. The following is a list of just a few of the safety features in your Audi:

- sophisticated safety belts for driver and all passenger seating positions,
- safety belt pretensioners,
- safety belt force limiters for the front seats,
- safety belt height adjustment systems for the front seats,
- automatic safety belt height adjustment for the rear seats,
- head restraints for each seating position,
- front airbags,
- side airbags in the front seats and outer rear seats*,
- side curtain airbags,
- special LATCH anchorages for child restraints,
- head restraints for each seating position,
- adjustable steering column.

These individual safety features, can work together as a system to help protect you and your passengers in a wide range of accidents. These features cannot work as a system if they are not always correctly adjusted and correctly used.

Safety is everybody's responsibility! ■

Important things to do before driving

Safety is everybody's job! Vehicle and occupant safety always depends on the informed and careful driver.

For your safety and the safety of your passengers, **before driving always:**

- Make sure that all lights and signals are operating correctly.
- Make sure that the tire pressure is correct.
- Make sure that all windows are clean and afford good visibility to the outside.
- Secure all luggage and other items carefully ⇒ *page 91*.
- Make sure that nothing can interfere with the pedals.
- Adjust front seat, head restraint and mirrors correctly for your height.
- Instruct passengers to adjust the head restraints according to their height.
- Make sure to use the right child restraint correctly to protect children ⇒ *page 167, "Child Safety"*.
- Sit properly in your seat and make sure that your passengers do the same ⇒ *page 73, "General recommendations"*.
- Fasten your safety belt and wear it properly. Also instruct your passengers to fasten their safety belts properly ⇒ *page 135*. ■

What impairs driving safety?

Safe driving is directly related to the condition of the vehicle, the driver as well as the driver's ability to concentrate on the road without being distracted.

The driver is responsible for the safety of the vehicle and all of its occupants. If your ability to drive is impaired, safety risks for everybody in the vehicle increase and you also become a hazard to everyone else on the road ⇒ . Therefore:

- Do not let yourself be distracted by passengers or by using a cellular telephone.
- NEVER drive when your driving ability is impaired (by medications, alcohol, drugs, etc.).
- Observe all traffic laws, rules of the road and speed limits and plain common sense.
- ALWAYS adjust your speed to road, traffic and weather conditions.
- Take frequent breaks on long trips. Do not drive for more than two hours at a stretch.
- Do NOT drive when you are tired, under pressure or when you are stressed.

WARNING

Impaired driving safety increases the risk of serious personal injury and death whenever a vehicle is being used. ■

Proper occupant seating positions

Proper seating position for the driver

The proper driver seating position is important for safe, relaxed driving.

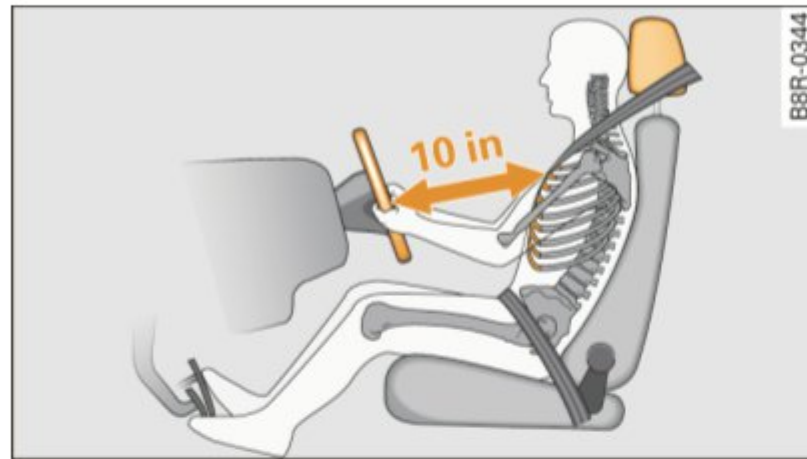

Fig. 122 Correct seating position

For your own safety and to reduce the risk of injury in the event of an accident, we recommend that you adjust the driver's seat to the following position:

- Adjust the driver's seat so that you can easily push the pedals all the way to the floor while keeping your knee(s) slightly bent ⇒ ⚠.
- Adjust the angle of the seatback so that it is in an upright position so that your back comes in full contact with it when you drive.
- Adjust the steering wheel so that there is a distance of at least 10 inches (25 cm) between the steering wheel and your breast bone ⇒ fig. 122. If not possible, see your authorized Audi dealership about adaptive equipment.
- Adjust the steering wheel so that the steering wheel and airbag cover points at your chest and not at your face.

- Grasp the top of the steering wheel with your elbow(s) slightly bent.
- Adjust the head restraint so the upper edge is as even as possible with the top of your head. If that is not possible, try to adjust the head restraint so that it is as close to this position as possible.
- Fasten and wear safety belts correctly ⇒ *page 139*.
- Always keep both feet in the footwell so that you are in control of the vehicle at all times.

For detailed information on how to adjust the driver's seat, see ⇒ *page 74*, "Adjusting front seats manually" or ⇒ *page 75*, "Adjusting the power seat".

⚠ WARNING

Drivers who are unbelted, out of position or too close to the airbag can be seriously injured by an airbag as it unfolds. To help reduce the risk of serious personal injury:

- Always adjust the driver's seat and the steering wheel so that there are at least 10 inches (25 cm) between your breastbone and the steering wheel.
- Always hold the steering wheel on the outside of the steering wheel rim with your hands at the 9 o'clock and 3 o'clock positions to help reduce the risk of personal injury if the driver's airbag inflates.
- Never hold the steering wheel at the 12 o'clock position or with your hands at other positions inside the steering wheel rim or on the steering wheel hub. Holding the steering wheel the wrong way can cause serious injuries to the hands, arms and head if the driver's airbag deploys.
- Pointing the steering wheel toward your face decreases the ability of the supplemental driver's airbag to protect you in a collision.

⚠ WARNING (continued)

- Always sit in an upright position and never lean against or place any part of your body too close to the area where the airbags are located.
- Before driving, always adjust the front seats and head restraints properly and make sure that all passengers are properly restrained.
- Never adjust the seats while the vehicle is moving. Your seat may move unexpectedly and you could lose control of the vehicle.
- Never drive with the backrest reclined or tilted far back! The farther the backrests are tilted back, the greater the risk of injury due to incorrect positioning of the safety belt and improper seating position.
- Children must always ride in child safety seats ⇒ *page 167*. Special precautions apply when installing a child safety seat on the front passenger seat ⇒ *page 145*. ■

Proper seating position for the front passenger

The proper front passenger seating position is important for safe, relaxed driving.

For your own safety and to reduce the risk of injury in the event of an accident, we recommend that you adjust the seat for the front passenger to the following position:

- Adjust the angle of the seatback so that it is in an upright position and your back comes in full contact with it whenever the vehicle is moving.
- Adjust the head restraint so the upper edge is as even as possible with the top of your head. If that is not possible, try to adjust the head restraint so that it is as close to this position as possible ⇒ *page 128*.

- Keep both feet flat on the floor in front of the front passenger seat.
- Fasten and wear safety belts correctly ⇒ *page 139*.

For detailed information on how to adjust the front passenger's seat, see ⇒ *page 73*.

⚠ WARNING

Front seat passengers who are unbelted, out of position or too close to the airbag can be seriously injured or killed by the airbag as it unfolds. To help reduce the risk of serious personal injury:

- Passengers must always sit in an upright position and never lean against or place any part of their body too close to the area where the airbags are located.
- Passengers who are unbelted, out of position or too close to the airbag can be seriously injured by an airbag as it unfolds with great force in the blink of an eye.
- Always make sure that there are at least 10 inches (25 cm) between the front passenger's breastbone and the instrument panel.
- Each passenger must always sit on a seat of their own and properly fasten and wear the safety belt belonging to that seat.
- Before driving, always adjust the front passenger seat and head restraint properly.
- Always keep your feet on the floor in front of the seat. Never rest them on the seat, instrument panel, out of the window, etc. The airbag system and safety belt will not be able to protect you properly and can even increase the risk of injury in a crash.
- Never drive with the backrest reclined or tilted far back! The farther the backrests are tilted back, the greater the risk of injury due to incorrect positioning of the safety belt and improper seating position.

! WARNING (continued)

- Children must always ride in child safety seats ⇒ *page 167*. Special precautions apply when installing a child safety seat on the front passenger seat ⇒ *page 145*. ■

Proper seating positions for passengers in rear seats

Rear seat passengers must sit upright with both feet on the floor consistent with their physical size and be properly restrained whenever the vehicle is in use.

To reduce the risk of injury caused by an incorrect seating position in the event of a sudden braking maneuver or an accident, your passengers on the rear bench seat must always observe the following:

- If there are passengers in the rear seat, slide the head restraints upward at least to the next notch on the occupied seats ⇒ *page 78*.
- Make sure that the seatback is securely latched in the upright position ⇒ *page 81*.
- Keep both feet flat in the footwell in front of the rear seat.
- Fasten and wear safety belts properly ⇒ *page 139*.
- Make sure that children are always properly restrained in a child restraint that is appropriate for their size and age ⇒ *page 167*.

! WARNING

Passengers who are improperly seated on the rear seat can be seriously injured in a crash.

! WARNING (continued)

- Each passenger must always sit on a seat of their own and properly fasten and wear the safety belt belonging to that seat.
- Safety belts only offer maximum protection when the seatback is securely latched in the upright position and the safety belts are properly positioned on the body. By not sitting upright, a rear seat passenger increases the risk of personal injury from improperly positioned safety belts!
- Always adjust the head restraint properly so that it can give maximum protection. ■

Proper adjustment of head restraints

Correctly adjusted head restraints are an important part of your vehicle's occupant restraint system and can help to reduce the risk of injuries in accident situations.

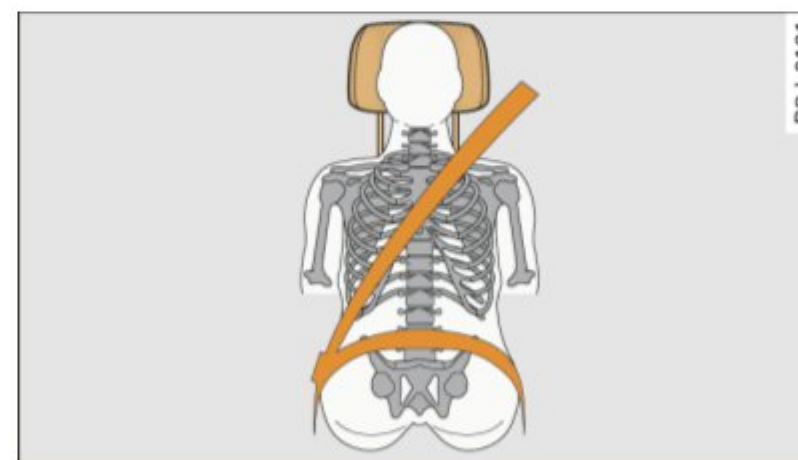

Fig. 123 Head restraint: viewed from the front

The head restraints must be correctly adjusted to achieve the best protection.

- Adjust the head restraints so the upper edge is as even as possible with the top of your head. If that is not possible, try to adjust the head restraint so that it is as close to this position as possible ⇒ *fig. 123*. ▶

- If there are passengers in the rear seat, slide the head restraints upward at least to the next notch on the occupied seats.

Adjusting head restraints ⇒ *page 77*.

WARNING

Driving without head restraints or with head restraints that are not properly adjusted increases the risk of serious or fatal neck injury dramatically. To help reduce the risk of injury:

- Always drive with the head restraints in place and properly adjusted.
- Every person in the vehicle must have a properly adjusted head restraint.
- Always make sure each person in the vehicle properly adjusts their head restraint. Adjust the head restraints so the upper edge is as even as possible with the top of your head. If that is not possible, try to adjust the head restraint so that it is as close to this position as possible.
- Never attempt to adjust head restraint while driving. If you have driven off and must adjust the driver headrest for any reason, first stop the vehicle safely before attempting to adjust the head restraint.
- Children must always be properly restrained in a child restraint that is appropriate for their age and size ⇒ *page 167*. ■

Examples of improper seating positions

The occupant restraint system can only reduce the risk of injury if vehicle occupants are properly seated.

Improper seating positions can cause serious injury or death. Safety belts can only work when they are properly positioned on the body. Improper seating positions reduce the effective-

ness of safety belts and will even increase the risk of injury and death by moving the safety belt to critical areas of the body. Improper seating positions also increase the risk of serious injury and death when an airbag deploys and strikes an occupant who is not in the proper seating position. A driver is responsible for the safety of all vehicle occupants and especially for children. Therefore:

- Never allow anyone to assume an incorrect seating position when the vehicle is being used ⇒ .

The following bulletins list only some sample positions that will increase the risk of serious injury and death. Our hope is that these examples will make you more aware of seating positions that are dangerous.

Therefore, whenever the vehicle is moving:

- never stand up in the vehicle
- never stand on the seats
- never kneel on the seats
- never ride with the seatback reclined
- never lie down on the rear seat
- never lean up against the instrument panel
- never sit on the edge of the seat
- never sit sideways
- never lean out the window
- never put your feet out the window
- never put your feet on the instrument panel
- never rest your feet on the seat cushion or back of the seat
- never ride in the footwell
- never ride in the cargo area

WARNING

Improper seating positions increase the risk of serious personal injury and death whenever a vehicle is being used.

- Always make sure that all vehicle occupants stay in a proper seating position and are properly restrained whenever the vehicle is being used. ■

Pedal area

Pedals

The pedals must always be free to move and must never be interfered with by a floor mat or any other object.

Make sure that all pedals move freely without interference and that nothing prevents them from returning to their original positions.

Only use floor mats that leave the pedal area free and can be secured with floor mat fasteners.

If a brake circuit fails, increased brake pedal travel is required to bring the vehicle to a full stop.

WARNING

Pedals that cannot move freely can cause loss of vehicle control and increase the risk of serious injury.

- Never place any objects in the driver's footwell. An object could get into the pedal area and interfere with pedal function. In case of sudden braking or an accident, you would not be able to brake or accelerate!
- Always make sure that nothing can fall or move into the driver's footwell. ■

Floor mats on the driver side

Always use floor mats that can be securely attached to the floor mat fasteners and do not interfere with the free movement of the pedals.

- Make sure that the floor mats are properly secured and cannot move and interfere with the pedals ⇒ .

Use only floor mats that leave the pedal area unobstructed and that are firmly secured so that they cannot slip out of position. You can obtain suitable floor mats from your authorized Audi Dealer.

Floor mat fasteners are installed in your Audi.

Floor mats used in your vehicle must be attached to these fasteners. Properly securing the floor mats will prevent them from sliding into positions that could interfere with the pedals or impair safe operation of your vehicle in other ways.

WARNING

Pedals that cannot move freely can result in a loss of vehicle control and increase the risk of serious personal injury.

- Always make sure that floor mats are properly secured.
- Never place or install floor mats or other floor coverings in the vehicle that cannot be properly secured in place to prevent them from slipping and interfering with the pedals or the ability to control the vehicle.
- Never place or install floor mats or other floor coverings on top of already installed floor mats. Additional floor mats and other coverings will reduce the size of the pedal area and interfere with the pedals.
- Always properly reinstall and secure floor mats that have been taken out for cleaning.
- Always make sure that objects cannot fall into the driver footwell while the vehicle is moving. Objects can become trapped

⚠ WARNING (continued)

under the brake pedal and accelerator pedal causing a loss of vehicle control. ■

Stowing luggage

Loading the luggage compartment

All luggage and other objects must be properly stowed and secured in the luggage compartment.

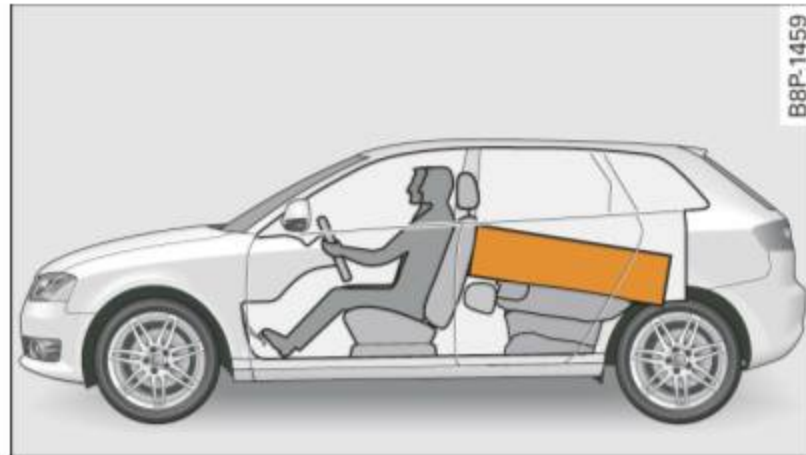

Fig. 124 Safe load positioning: heavy cargo positioned as far forward as possible.

Loose items in the luggage compartment can shift suddenly, changing vehicle handling characteristics. Loose items can also increase the risk of serious personal injury in a sudden vehicle maneuver or in a collision.

- Distribute the load evenly in the luggage compartment.
- Always place and properly secure heavy items in the luggage compartment as far forward as possible ⇒ fig. 124.
- Secure luggage using the tie-downs provided ⇒ page 82.

- Make sure that the rear seatback is securely latched in place.

⚠ WARNING

Improperly stored luggage or other items can fly through the vehicle causing serious personal injury in the event of hard braking or an accident. To help reduce the risk of serious personal injury:

- Always put objects, for example, luggage or other heavy items in the luggage compartment.
- Always secure objects in the luggage compartment using the tie-down eyelets and suitable straps.

⚠ WARNING

Heavy loads will influence the way your vehicle handles. To help reduce the risk of a loss of control leading to serious personal injury:

- Always keep in mind when transporting heavy objects, that a change in the center of gravity can also cause changes in vehicle handling:
 - Always distribute the load as evenly as possible.
 - Place heavy objects as far forward in the luggage compartment as possible.
- Never exceed the Gross Axle Weight Rating or the Gross Vehicle Weight Rating specified on the safety compliance sticker on the left door jamb. Exceeding permissible weight standards can cause the vehicle to slide and handle differently.
- Please observe information on safe driving ⇒ page 124.

⚠ WARNING

To help prevent poisonous exhaust gas from being drawn into the vehicle, always keep the rear lid closed while driving. ▶

 **WARNING** (continued)

- **Never transport objects larger than those fitting completely into the luggage area because the rear lid cannot be fully closed.**
- **If you absolutely must drive with the rear lid open, observe the following notes to reduce the risk of poisoning:**
 - Close all windows,
 - Close the power roof*,
 - Open all air outlets in the instrument panel,
 - Switch off the air recirculation,
 - Set the fresh air fan to the highest speed.

 **WARNING**

Always make sure that the doors, all windows, the power roof* and the rear lid are securely closed and locked to reduce the risk of injury when the vehicle is not being used.

- **After closing the rear lid, always make sure that it is properly closed and locked.**
- **Never leave your vehicle unattended especially with the rear lid left open. A child could crawl into the vehicle through the luggage compartment and close the rear lid becoming trapped and unable to get out. Being trapped in a vehicle can lead to serious personal injury.**
- **Never let children play in or around the vehicle.**
- **Never let passengers ride in the luggage compartment. Vehicle occupants must always be properly restrained in one of the vehicle's seating positions.**

 **Tips**

- The tire pressure must correspond to the load - see the tire pressure sticker on the fuel filler door.

- The tire pressure must correspond to the load. The tire pressure is shown on the tire pressure label. On USA vehicles, the tire pressure label is located on the driver's side B-pillar. On Canada vehicles, the tire pressure label is located either on the driver's side B-pillar or inside the fuel filler flap. The tire pressure label lists the recommended cold tire inflation pressures for the vehicle at its maximum capacity weight and the tires that were on your vehicle at the time it was manufactured. For recommended tire pressures for normal load conditions, please see chapter ⇒ *page 249*. ■

Tie-downs

The luggage compartment is equipped with four tie-downs to secure luggage and other items.

Use the tie-downs to secure your cargo properly ⇒ *page 131*, "Loading the luggage compartment".

In a collision, the laws of physics mean that even smaller items that are loose in the vehicle will become heavy missiles that can cause serious injury. Items in the vehicle possess energy which vary with vehicle speed and the weight of the item. Vehicle speed is the most significant factor.

For example, in a frontal collision at a speed of 30 mph (48 km/h), the forces acting on a 10-lb (4.5 kg) object are about 20 times the normal weight of the item. This means that the weight of the item would suddenly be about 200 lbs. (90 kg). You can imagine the injuries that a 200 lbs. (90 kg) item flying freely through the passenger compartment could cause in a collision like this.

 **WARNING**

Weak, damaged or improper straps used to secure items to tie-downs can fail during hard braking or in a collision and cause serious personal injury.

⚠ WARNING (continued)

- Always use suitable mounting straps and properly secure items to the tie-downs in the luggage compartment to help prevent items from shifting or flying forward as dangerous missiles.
- When the rear seat backrest is folded down, always use suitable mounting straps and properly secure items to the tie-downs in the luggage compartment to help prevent items from flying forward as dangerous missiles into the passenger compartment.
- Never attach a child safety seat tether strap to a tie-down. ■

Reporting Safety Defects

Applicable to U.S.A.

If you believe that your vehicle has a defect which could cause a crash or could cause injury or death, you should immediately inform the National Highway Traffic Safety Administration (NHTSA) in addition to notifying Audi of America, Inc.

If NHTSA receives similar complaints, it may open an investigation, and if it finds that a safety defect exists in a group of vehicles, it may order a recall and remedy campaign. However, NHTSA cannot become involved in individual problems between you, your dealer, or Audi of America, Inc.

To contact NHTSA, you may call the Vehicle Safety Hotline toll-free at:

Tel.: 1-888-327-4236 (TTY: 1-800-424-9153)

or write to:

Administrator
NHTSA
1200 New Jersey Avenue, SE
Washington, D.C. 20590

You can also obtain other information about motor vehicle safety from:

<http://www.safercar.gov>

Applicable to Canada

Canadian customers who wish to report a safety-related defect to Transport Canada, Defect Investigations and Recalls, may telephone the toll free hotline:

Tel.: 1-800-333-0371 or

Tel.: 1-613-998-8616 if you are in the Ottawa area

TTY for hearing impaired: 1-888-675-6863

email comments/questions to: roadsafetyweb-mail@tc.gc.ca

or contact Transport Canada by mail at:

Road Safety and Motor Vehicle Regulation
Directorate
Transport Canada

Tower C, Place de Ville,
330 Sparks Street
Ottawa, Ontario K1A 0N5

For additional road safety information, please
visit the Road Safety website at:

<http://www.tc.gc.ca/roadsafety/index.htm> ■

Safety belts

General notes

Always wear safety belts!

Wearing safety belts correctly saves lives!

This chapter explains why safety belts are necessary, how they work and how to adjust and wear them correctly.

- Read all the information that follows and heed all of the instructions and WARNINGS.

WARNING

Not wearing safety belts or wearing them improperly increases the risk of serious personal injury and death.

- Safety belts are the single most effective means available to reduce the risk of serious injury and death in automobile accidents. For your protection and that of your passengers, always correctly wear safety belts when the vehicle is moving.
- Pregnant women, injured, or physically impaired persons must also use safety belts. Like all vehicle occupants, they are more likely to be seriously injured if they do not wear safety belts. The best way to protect a fetus is to protect the mother - throughout the entire pregnancy. ■

Number of seats

Your Audi has a total of five seating positions: two in the front and three in the rear. Each seating position has a safety belt.

WARNING

Not wearing safety belts or wearing them improperly increases the risk of serious personal injury and death.

- Never strap more than one person, including small children, into any belt. It is especially dangerous to place a safety belt over a child sitting on your lap.
- Never let more people ride in the vehicle than there are safety belts available.
- Be sure everyone riding in the vehicle is properly restrained with a separate safety belt or child restraint. ■

Safety belt warning light

Your vehicle has a warning system for the driver and front seat passenger (on USA models only) to remind you about the importance of buckling-up.



Fig. 125 Safety belt warning light in the instrument cluster - enlarged

Before driving off, always:

- Fasten your safety belt and make sure you are wearing it properly. ▶

- Make sure that your passengers also buckle up and properly wear their safety belts.
- Protect children with a child restraint system appropriate for the size and age.

The warning light  in the instrument cluster lights up when the ignition is switched on as a reminder to fasten the safety belts. In addition, you will hear a warning tone for a certain period of time.

Fasten your safety belt and make sure that your passengers also properly put on their safety belts.

WARNING

- Safety belts are the single most effective means available to reduce the risk of serious injury and death in automobile accidents. For your protection and that of your passengers, always correctly wear safety belts when the vehicle is moving.
- Failure to pay attention to the warning light that come on, could lead to personal injury. ■

Why safety belts?

Frontal collisions and the law of physics

Frontal crashes create very strong forces for people riding in vehicles.

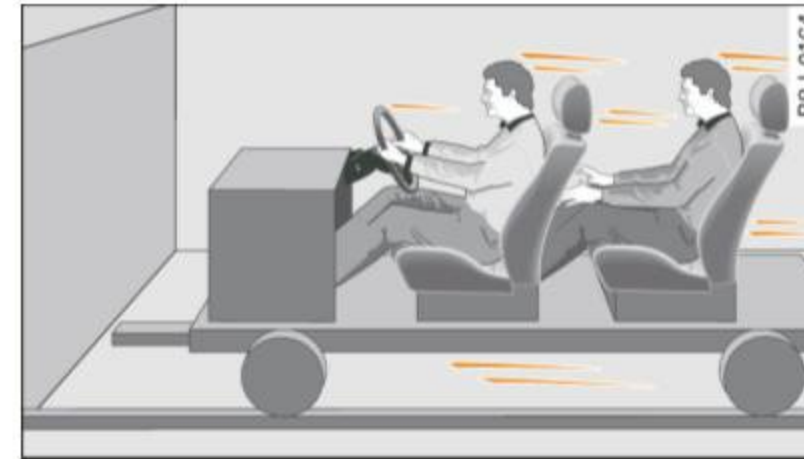

Fig. 126 Unbelted occupants in a vehicle heading for a wall



Fig. 127 The vehicle crashes into the wall

The physical principles are simple. Both the vehicle and the passengers possess energy which varies with vehicle speed and body weight. Engineers call this energy “kinetic energy.”

The higher the speed of the vehicle and the greater the vehicle's weight, the more energy that has to be “absorbed” in the crash.

Vehicle speed is the most significant factor. If the speed doubles from 15 to 30 mph (25 to 50 km/h), the energy increases 4 times! ▶

Because the passengers of this vehicle are not using safety belts ⇒ page 136, fig. 126, they will keep moving at the same speed the vehicle was moving just before the crash, until something stops them - here, the wall ⇒ page 136, fig. 127.

The same principles apply to people sitting in a vehicle that is involved in a frontal collision. Even at city speeds of 20 to 30 mph (30 to 50 km/h), the forces acting on the body can reach one ton (2,000 lbs. or 1,000 kg) or more. At greater speeds, these forces are even higher.

People who do not use safety belts are also not attached to their vehicle. In a frontal collision they will also keep moving forward at the speed their vehicle was travelling just before the crash. Of course, the laws of physics don't just apply to frontal collisions, they determine what happens in all kinds of accidents and collisions. ■

What happens to occupants not wearing safety belts?

In crashes unbelted occupants cannot stop themselves from flying forward and being injured or killed. Always wear your safety belts!



Fig. 128 A driver not wearing a safety belt is violently thrown forward



Fig. 129 A rear passenger not wearing a safety belt will fly forward and strike the driver

Unbelted occupants are not able to resist the tremendous forces of impact by holding tight or bracing themselves. Without the benefit of safety restraint systems, the unrestrained occupant will slam violently into the steering wheel, instrument panel, windshield, or whatever else is in the way ⇒ fig. 128. This impact with the vehicle interior has all the energy they had just before the crash.

Never rely on airbags alone for protection. Even when they deploy, airbags provide only additional protection. Airbags are not supposed to deploy in all kinds of accidents. Although your Audi is equipped with airbags, all vehicle occupants, including the driver, must wear safety belts correctly in order to minimize the risk of severe injury or death in a crash.

Remember too, that airbags will deploy only once and that your safety belts are always there to offer protection in those accidents in which airbags are not supposed to deploy or when they have already deployed. Unbelted occupants can also be thrown out of the vehicle where even more severe or fatal injuries can occur.

It is also important for the rear passengers to wear safety belts correctly. Unbelted passengers in the rear seats endanger not only themselves but also the driver and other passengers ⇒ fig. 129. In a frontal collision they will be thrown forward violently, where they can hit and injure the driver and/or front seat passenger. ■

Safety belts protect

People think it's possible to use the hands to brace the body in a minor collision. It's simply not true!



Fig. 130 Driver is correctly restrained in a sudden braking maneuver

Safety belts used properly can make a big difference. Safety belts help to keep passengers in their seats, gradually reduce energy levels applied to the body in an accident, and help prevent the uncontrolled movement that can cause serious injuries. In addition, safety belts reduce the danger of being thrown out of the vehicle.

Safety belts attach passengers to the car and give them the benefit of being slowed down more gently or “softly” through the “give” in the safety belts, crush zones and other safety features engineered into today's vehicles. By “absorbing” the kinetic energy over a longer period of time, the safety belts make the forces on the body more “tolerable” and less likely to cause injury.

Although these examples are based on a frontal collision, safety belts can also substantially reduce the risk of injury in other kinds of crashes. So, whether you're on a long trip or just going to the corner store, always buckle up and make sure others do, too. Accident statistics show that vehicle occupants properly wearing safety belts have a lower risk of being injured and a much better chance of surviving an accident. Properly using safety belts also greatly increases the ability of the supplemental airbags to do their job in a collision. For this reason, wearing a safety belt is legally required in most countries including much of the United States and Canada.

Although your Audi is equipped with airbags, you still have to wear the safety belts provided. Front airbags, for example, are activated only in some frontal collisions. The front airbags are not activated in all frontal collisions, in side and rear collisions, in roll overs or in cases where there is not enough deceleration through impact to the front of the vehicle. The same goes for the other airbag systems in your Audi. So, always wear your safety belt and make sure everybody in your vehicle is properly restrained! ■

Important safety instructions about safety belts

Safety belts must always be correctly positioned across the strongest bones of your body.

- Always wear safety belts as illustrated and described in this chapter.
- Make sure that your safety belts are always ready for use and are not damaged.

WARNING

Not wearing safety belts or wearing them improperly increases the risk of serious personal injury and death. Safety belts can work only when used correctly.

- Always fasten your safety belts correctly before driving off and make sure all passengers are correctly restrained.
- For maximum protection, safety belts must always be positioned properly on the body.
- Never strap more than one person, including small children, into any belt.
- Never place a safety belt over a child sitting on your lap.
- Always keep feet in the footwell in front of the seat while the vehicle is being driven.

⚠ WARNING (continued)

- Never let any person ride with their feet on the instrument panel or sticking out the window or on the seat.
- Never remove a safety belt while the vehicle is moving. Doing so will increase your risk of being injured or killed.
- Never wear belts twisted.
- Never wear belts over rigid or breakable objects in or on your clothing, such as eye glasses, pens, keys, etc., as these may cause injury.
- Never allow safety belts to become damaged by being caught in door or seat hardware.
- Do not wear the shoulder part of the belt under your arm or otherwise out of position.
- Several layers of heavy clothing may interfere with correct positioning of belts and reduce the overall effectiveness of the system.
- Always keep belt buckles free of anything that may prevent the buckle from latching securely.
- Never use comfort clips or devices that create slack in the shoulder belt. However, special clips may be required for the proper use of some child restraint systems.
- Torn or frayed safety belts can tear, and damaged belt hardware can break in an accident. Inspect belts regularly. If webbing, bindings, buckles, or retractors are damaged, have belts replaced by an authorized Audi dealer or qualified workshop.
- Safety belts that have been worn and loaded in an accident must be replaced with the correct replacement safety belt by an authorized Audi dealer. Replacement may be necessary even if damage cannot be clearly seen. Anchorages that were loaded must also be inspected.
- Never remove, modify, disassemble, or try to repair the safety belts yourself.

⚠ WARNING (continued)

- Always keep the belts clean. Dirty belts may not work properly and can impair the function of the inertia reel ⇒ *page 217*, "Safety belts". ■

Safety belts

Fastening safety belts

Seat first - everybody buckle up!



Fig. 131 Belt buckle and tongue on the driver's seat

To provide maximum protection, safety belts must always be positioned correctly on the wearer's body.

- Adjust the front seat and head restraint properly ⇒ *page 73*, "General recommendations".
- Make sure the seatback of the rear seat bench is in an upright position and securely latched in place before using the belt ⇒ ⚠.
- Hold the belt by the tongue and pull it evenly across the chest and pelvis ⇒ ⚠.

- Insert the tongue into the correct buckle of your seat until you hear it latch securely ⇒ fig. 131.
- Pull on the belt to make sure that it is securely latched in the buckle.

Automatic safety belt retractors

Every safety belt is equipped with an automatic belt retractor on the shoulder belt. This feature locks the belt when the belt is pulled out fast, during hard braking and in an accident. The belt may also lock when you drive up or down a steep hill or through a sharp curve. During normal driving the belt lets you move freely.

Safety belt pretensioners

The safety belts are equipped with a belt pretensioner that helps to tighten the safety belt and remove slack when the pretensioner is activated. The function of the pretensioner is monitored by a warning light ⇒ page 15.

Switchable locking feature

Every safety belt except the one on the driver seat is equipped with a switchable locking feature that **must** be used when the safety belt is used to attach a child safety seat. Be sure to read the important information about this feature ⇒ page 177.

WARNING

Improperly positioned safety belts can cause serious injury in an accident ⇒ page 140, “Safety belt position”.

- Safety belts offer optimum protection only when the seatback is upright and belts are properly positioned on the body.
- Always make sure that the rear seat backrest to which the center rear safety belt is attached is securely latched whenever the rear center safety belt is being used. If the backrest is not securely latched, the passenger will move forward with the backrest during sudden braking, in a sudden maneuver and especially in a crash.

WARNING (continued)

- Never attach the safety belt to the buckle for another seat. Attaching the belt to the wrong buckle will reduce safety belt effectiveness and can cause serious personal injury.
- A passenger who is not properly restrained can be seriously injured by the safety belt itself when it moves from the stronger parts of the body into critical areas like the abdomen.
- Always lock the convertible locking retractor when you are securing a child safety seat in the vehicle ⇒ page 179. ■

Safety belt position

Correct belt position is the key to getting maximum protection from safety belts.

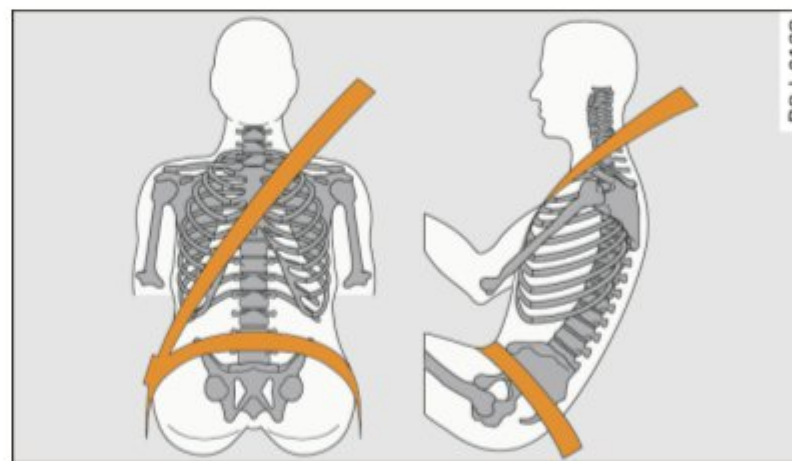

Fig. 132 Head restraint and safety belt position as seen from the side

Standard features on your vehicle help you adjust the position of the safety belt to match your body size.

- belt height adjustment for the front seats,
- automatic belt height adjustment for the rear seats. ▶

WARNING

Improperly positioned safety belts can cause serious personal injury in an accident.

- The shoulder belt portion of the safety belt must be positioned over the middle of the occupant's shoulder and never across the neck or throat.
- The safety belt must lie flat and snug on the occupant's upper body ⇒ fig. 132. Pull on the belt to tighten if necessary.
- The lap belt portion of the safety belt must be positioned as low as possible across pelvis and never over the abdomen. Make sure the belt lies flat and snug ⇒ fig. 132. Pull on the belt to tighten if necessary.
- A loose-fitting safety belt can cause serious injuries by shifting its position on your body from the strong bones to more vulnerable, soft tissue and cause serious injury.
- Always read and heed all WARNINGS and other important information ⇒ page 138. ■

Pregnant women must also be correctly restrained

The best way to protect the fetus is to make sure that expectant mothers always wear safety belts correctly - throughout the pregnancy.



Fig. 133 Safety belt position during pregnancy

To provide maximum protection, safety belts must always be positioned correctly on the wearer's body ⇒ page 140.

- Adjust the front seat and head restraint correctly ⇒ page 73, "General recommendations".
- Make sure the seatback of the rear seat bench is in an upright position and securely latched in place before using the belt.
- Hold the belt by the tongue and pull it evenly across the chest and pelvis ⇒ fig. 133, ⇒ .
- Insert the tongue into the correct buckle of your seat until you hear it latch securely ⇒ page 139, fig. 131.
- Pull on the belt to make sure that it is securely latched in the buckle.

! WARNING

Improperly positioned safety belts can cause serious personal injury in an accident.

- Expectant mothers must always wear the lap portion of the safety belt as low as possible across the pelvis and below the rounding of the abdomen.
- Always read and heed all WARNINGS and other important information ⇒ **!** in “Fastening safety belts” on page 139. ■

Unfastening safety belts

Unbuckle the safety belt with the red release button only after the vehicle has stopped.



Fig. 134 Releasing the tongue from the buckle

- Push the red release button on the buckle ⇒ page 142, fig. 134. The belt tongue will spring out of the buckle ⇒ **!**.
- Let the belt wind up on the retractor as you guide the belt tongue to its stowed position.

! WARNING

Never unfasten safety belt while the vehicle is moving. Doing so will increase your risk of being injured or killed. ■

Adjusting safety belt height

With the aid of the safety belt height adjustment, the three point safety belt strap routing can be fitted to the shoulder area, according to body size.

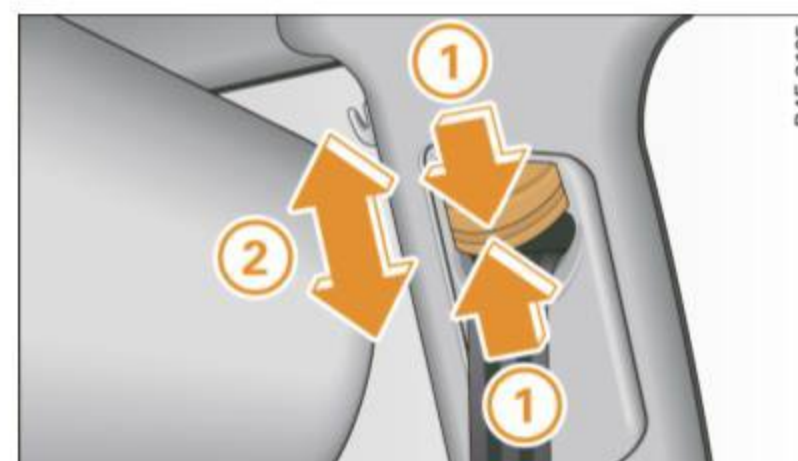

Fig. 135 Safety belt height adjustment for the front seats – loop-around fittings

- Push the loop-around fittings **up** ⇒ fig. 135 (2), or
- squeeze together the (1) button, and push the loop-around fittings **down** (2).
- Pull the belt to make sure that the upper attachment is properly engaged.

! WARNING

Always read and heed all WARNINGS and other important information ⇒ page 138. ▶



Tips

- The shoulder belt part should route approximately over the middle of your shoulder – under no circumstances should it route over your neck and throat area ⇒  in “Safety belt position” on page 140.
- With the front seats, the height adjustment of the seat can also be used to adjust the position of the safety belts. ■

Improperly worn safety belts

Incorrectly positioned safety belts can cause severe injuries.

Wearing safety belts improperly can cause serious injury or death. Safety belts can only work when they are correctly positioned on the body. Improper seating positions reduce the effectiveness of safety belts and will even increase the risk of injury and death by moving the safety belt to critical areas of the body. Improper seating positions also increase the risk of serious injury and death when an airbag deploys and strikes an occupant who is not in the correct seating position. A driver is responsible for the safety of all vehicle occupants and especially for children. Therefore:

- Never permit anyone to assume an incorrect sitting position in the vehicle while traveling ⇒ .

The following lists only some examples of improperly worn safety belts that will increase the risk of serious injury and death. Our hope is that these examples will make you more aware of seating positions that are dangerous.

Therefore, whenever the vehicle is moving:

- never wear the shoulder belt under your arm
- never let the shoulder belt pass over your neck
- never wear the safety belt loosely

- never place the lap belt portion of the safety belt across your abdomen ⇒ .

WARNING

Improperly worn safety belts increase the risk of serious personal injury and death whenever a vehicle is being used.

- Always make sure that all vehicle occupants are correctly restrained and stay in a correct seating position whenever the vehicle is being used.
- Always read and heed all WARNINGS and other important information ⇒ page 138. ■

Safety belt pretensioners

How safety belt pretensioners work

In front, side and rear end collisions above a particular severity, safety belts are tensioned automatically.

The safety belts are equipped with safety belt pretensioners. The system is activated by sensors in front, side and rear-end collisions of great severity. This tightens the belt and takes up belt slack ⇒  in “Service and disposal of safety belt pretensioner”. Taking up the slack helps to reduce forward occupant movement during a collision.

Note

Never let the belt remain over a rear seatback that has been folded forward.

Tips

The safety belt pretensioners can only be activated once. ►

- In minor frontal and side collisions, in rear-end collisions, in a roll-over and in accidents involving very little impact force, the safety belt pretensioner are not activated.
- When the safety belt pretensioners are activated, a fine dust is released. This is normal and is not caused by a fire in the vehicle.
- The relevant safety requirements must be observed when the vehicle or components of the system are scrapped. A qualified workshop is familiar with these regulations and will be pleased to pass on the information to you.
- Be sure to observe all safety, environmental and other regulations if the vehicle or individual parts of the system, particularly the safety belt or airbag, are to be disposed. We recommend you have your authorized Audi dealer perform this service for you. ■

Service and disposal of safety belt pretensioner

The safety belt pre-tensioners are parts of the safety belt and installed at the outboard seating positions on your Audi. Installing, removing, servicing or repairing of belt pre-tensioners can damage the safety belt system and prevent that system from working properly in a collision.

There are some important things you have to know to make sure that the effectiveness of the system will not be impaired and that discarded components do not cause injury or pollute the environment.

WARNING

Improper care, servicing and repair procedures can increase the risk of personal injury and death by preventing a safety belt tensioner from activating when needed or activating it unexpectedly:

WARNING (continued)

- **The safety belt pre-tensioner system can be activated only once. If safety belt pre-tensioners have been activated, then they must be replaced.**
- **Never repair, adjust, or change any parts of the safety belt system.**
- **Safety belt systems including safety belt pre-tensioners cannot be repaired. Special procedures are required for removal, installation and disposal of this system.**
- **For any work on the safety belt system, we strongly recommend that you see your authorized Audi dealer or qualified technician who has a Audi approved repair manual, training and special equipment necessary.**



For the sake of the environment

Undeployed airbag modules and pretensioners might be classified as Perchlorate Material -special handling may apply, see www.dtsc.ca.gov/hazardouswaste/perchlorate. When the vehicle or parts of the restraint system including airbag modules safety belts with pretensioners are scrapped, all applicable laws and regulations must be observed. Your authorized Audi dealer is familiar with these requirements and we recommend that you have your dealer perform this service for you. ■

Airbag system

Important things to know

Importance of wearing safety belts and sitting properly

Airbags are only supplemental restraints. For airbags to do their job, occupants must always properly wear their safety belts and be in a proper seating position.

For your safety and the safety of your passengers, before driving off, always:

- Adjust the driver's seat and steering wheel properly ⇒ *page 126*,
- Adjust the front passenger's seat properly ⇒ *page 74*,
- Wear safety belts properly ⇒ *page 138*,
- Always properly use the proper child restraint to protect children ⇒ *page 167*.

In a collision, airbags must inflate within the blink of an eye and with considerable force. The supplemental airbags can cause injuries if the driver or the front seat passenger is not seated properly. Therefore in order to help the airbag to do its job, it is important, both as a driver and as a passenger to sit properly at all times.

By keeping room between your body and the steering wheel and the front of the passenger compartment, the airbag can inflate fully and completely and provide supplemental protection in certain frontal collisions ⇒ *page 126*. For details on the operation of the seat adjustment controls ⇒ *page 75*.

It's especially important that children are properly restrained ⇒ *page 167*.

There is a lot that the driver and the passengers can and must do to help the individual safety features installed in your Audi work together as a system.

Proper seating position is important so that the front airbag on the driver side can do its job. If you have a physical impairment or condition that prevents you from sitting properly on the driver seat with the safety belt properly fastened and reaching the pedals, or if you have concerns with regard to the function or operation of the Advanced Airbag System, please contact your authorized Audi dealer or other qualified workshop, or call Audi Customer CARE at 1-800-822-2834 for possible modifications to your vehicle.

When the airbag system deploys, a gas generator will fill the airbags, break open the padded covers, and inflate between the steering wheel and the driver and between the instrument panel and the front passenger. The airbags will deflate immediately after deployment so that the front occupants can see through the windshield again without interruption.

All of this takes place in the blink of an eye, so fast that many people don't even realize that the airbags have deployed. The airbags also inflate with a great deal of force and nothing should be in their way when they deploy. Front airbags in combination with properly worn safety belts slow down and limit the occupant's forward movement. Together they help to prevent the driver and front seat passenger from hitting parts of the inside of the vehicle while reducing the forces acting on the occupant during the crash. In this way they help to reduce the risk of injury to the head and upper body in the crash. Airbags do not protect the arms or the lower parts of the body.

Both front airbags will not inflate in all frontal collisions. The triggering of the airbag system depends on the vehicle deceleration rate caused by the collision and registered by the electronic control unit. If this rate is below the reference value programmed into the control unit, the airbags will not be triggered, even though the car may be badly damaged as a result of the collision. Vehicle damage, repair

costs or even the lack of vehicle damage is not necessarily an indication of whether an airbag should inflate or not.

Since the circumstances will vary considerably between one collision and another, it is not possible to define a range of vehicle speeds that will cover every possible kind and angle of impact that will always trigger the airbags. Important factors include, for example, the nature (hard or soft) of the object which the car hits, the angle of impact, vehicle speed, etc. The front airbags will also not inflate in side or rear collisions, or in roll-overs.

Always remember: Airbags will deploy only once, and only in certain kinds of collisions. Your safety belts are always there to offer protection in those situations in which airbags are not supposed to deploy, or when they have already deployed; for example, when your vehicle strikes or is struck by another vehicle after the first collision.

This is just one of the reasons why an airbag is a supplementary restraint and is not a substitute for a safety belt. The airbag system works most effectively when used with the safety belts. Therefore, always properly wear your safety belts ⇒ *page 135*.

WARNING

Sitting too close to the steering wheel or instrument panel will decrease the effectiveness of the airbags and will increase the risk of personal injury in a collision.

- Never sit closer than 10 inches (25 cm) to the steering wheel or instrument panel.
- If you cannot sit more than 10 inches (25 cm) from the steering wheel, investigate whether adaptive equipment may be available to help you reach the pedals and increase your seating distance from the steering wheel.
- If you are unrestrained, leaning forward, sitting sideways or out of position in any way, your risk of injury is much higher.
- You will also receive serious injuries and could even be killed if you are up against the airbag or too close to it when it inflates - even with an Advanced Airbag.

WARNING (continued)

- To reduce the risk of injury when an airbag inflates, always wear safety belts properly ⇒ *page 139*, “Safety belts”.
- Always make certain that children age 12 or younger always ride in the rear seat. If children are not properly restrained, they may be severely injured or killed when an airbag inflates.
- Never let children ride unrestrained or improperly restrained in the vehicle. Adjust the front seats properly.
- Never ride with the backrest reclined.
- Always sit as far as possible from the steering wheel or the instrument panel ⇒ *page 126*.
- Always sit upright with your back against the backrest of your seat.
- Never place your feet on the instrument panel or on the seat. Always keep both feet on the floor in front of the seat to help prevent serious injuries to the legs and hips if the airbag inflates.
- Never recline the front passenger's seat to transport objects. Items can also move into the area of the side airbag or the front airbag during braking or in a sudden maneuver. Objects near the airbags can become projectiles and cause injury when an airbag inflates.

WARNING

Airbags that have deployed in a crash must be replaced.

- Use only original equipment airbags approved by Audi and installed by a trained technician who has the necessary tools and diagnostic equipment to properly replace any airbag in your vehicle and assure system effectiveness in a crash.
- Never permit salvaged or recycled airbags to be installed in your vehicle. ■

Child restraints on the front seat – some important things to know

- Be sure to read the important information and head the **WARNINGS** for important details about children and Advanced Airbags ⇒ *page 167*.

Even though your vehicle is equipped with an Advanced Airbag System, make certain that all children, especially those 12 years and younger, always ride in the back seat properly restrained for their age and size. The airbag on the passenger side makes the front seat a potentially dangerous place for a child to ride. The front seat is not the safest place for a child in a forward-facing child safety seat. It can be a very dangerous place for an infant or a child in a rearward-facing seat.

The Advanced Airbag System in your vehicle has been certified to comply with the requirements of United States Federal Motor Vehicle Safety Standard 208 as applicable at the time your vehicle was manufactured.

The Standard requires the front airbag on the passenger side to be turned off (“suppressed”) if a child up to about one year of age restrained in one of the rear-facing or forward-facing infant restraints listed in Federal Motor Vehicle Safety Standard 208 with which the Advanced Airbag System in your vehicle was certified has been installed on the front passenger seat. For a listing of the child restraints that were used to certify compliance with the US Safety Standard ⇒ *page 169*.

The **PASSENGER AIR BAG OFF** light in the instrument panel tells you when the front Advanced Airbag on the passenger side has been turned off by the electronic control unit.

Each time you turn on the ignition, the **PASSENGER AIR BAG OFF** light will come on for a few seconds and:

- will stay on if the front passenger seat is not occupied,

- will stay on if there is a small child or child restraint on the front passenger seat,
- will go off if the front passenger seat is occupied by an adult as registered by the weight-sensing mat ⇒ *page 156*, “Monitoring the Advanced Airbag System”.

The **PASSENGER AIR BAG OFF** light comes on when the control unit detects a total weight on the front passenger seat that requires the front airbag to be turned off.

If the total weight on the front passenger seat is more than that of a typical 1 year-old child but less than the weight of a small adult, the front airbag on the passenger side can deploy (the **PASSENGER AIR BAG OFF** light does not come on). If the **PASSENGER AIR BAG OFF** light does not come on, the front airbag on the passenger side has not been turned off by the electronic control unit and can deploy if the control unit senses an impact that meets the conditions stored in its memory.

For example, the airbag may deploy if:

- a small child that is heavier than a typical 1 year-old child is on the front passenger seat (regardless of whether the child is in one of the child safety seats listed ⇒ *page 169*), or
- a child who has outgrown child restraints is on the front passenger seat.

If the front passenger airbag is turned off, the **PASSENGER AIR BAG OFF** light comes on in the instrument cluster and stays on.

The front airbag on the passenger side may **not** deploy (the **PASSENGER AIR BAG OFF** light does not illuminate and stay lit) even if a small adult or teenager, or a passenger who is not sitting upright with their back against a non-reclined backrest with their feet on the vehicle floor in front of the seat is on the front passenger seat ⇒ *page 126*, “Proper seating position for the driver”.

If the front passenger airbag deploys, the Federal Standard requires the airbag to meet the “low risk” deployment criteria to reduce the risk of injury through interaction with the airbag. “Low risk” deployment occurs in those crashes that take place at lower decelerations as ►

defined in the electronic control unit ⇒ *page 157*, “PASSENGER AIR BAG OFF light”.

Always remember, a child safety seat or infant carrier installed on the front seat may be struck and knocked out of position by the rapidly inflating passenger's airbag in a frontal collision. The airbag could greatly reduce the effectiveness of the child restraint and even seriously injure the child during inflation.

For this reason, and because the back seat is the safest place for children - when properly restrained according to their age and size - we strongly recommend that children always sit in the back seat ⇒ *page 167*, “Child Safety”.

WARNING

A child in a rearward-facing child safety seat installed on the front passenger seat will be seriously injured and can be killed if the front airbag inflates - even with an Advanced Airbag System.

- The inflating airbag will hit the child safety seat or infant carrier with great force and will smash the child safety seat and child against the backrest, center armrest, door or roof.
- Always install rear-facing child safety seats on the rear seat.
- If you must install a rearward facing child safety seat on the front passenger seat because of exceptional circumstances and the PASSENGER AIR BAG OFF light does not come on and stay on, immediately install the rear-facing child safety seat in a rear seating position and have the airbag system inspected by your authorized Audi dealer.
- Forward-facing child safety seats installed on the front passenger's seat may interfere with the deployment of the airbag and cause serious personal injury to the child.

WARNING

If, in exceptional circumstances, you must install a forward-facing child restraint on the front passenger's seat:

WARNING (continued)

- Always make sure the forward-facing seat has been designed and certified by its manufacturer for use on a front seat with a passenger front and side airbag.
- Never put the forward-facing child restraint up against or very near the instrument panel.
- Always move the passenger seat into its rearmost position in the seat's fore and aft adjustment range, as far away from the airbag as possible before installing the forward-facing child restraint. The backrest must be adjusted to an upright position.
- Make sure that the PASSENGER AIR BAG OFF light comes on and stays on all the time whenever the ignition is switched on.

WARNING

To reduce the risk of serious injury, make sure that the PASSENGER AIR BAG OFF light will be displayed whenever a child restraint is installed on the front passenger seat and the ignition is switched on.

- If the PASSENGER AIR BAG OFF light does not stay on, perform the checks described ⇒ *page 156*, “Monitoring the Advanced Airbag System”.
- Take the child restraint off the front passenger seat and install it properly at one of the rear seat positions if the PASSENGER AIR BAG OFF light does not stay on.
- Have the airbag system inspected by your authorized Audi dealer immediately.
- Always carefully follow instructions from child restraint manufacturers when installing child restraints.

WARNING

If, in exceptional circumstances, you must install a forward or rearward-facing child restraint on the front passenger's seat: 

⚠ WARNING (continued)

- Improper installation of child restraints can reduce their effectiveness or even prevent them from providing any protection.
- An improperly installed child restraint can interfere with the airbag as it deploys and seriously injure or even kill the child – even with an Advanced Airbag System.
- Always carefully follow the manufacturer's instructions provided with the child safety seat or carrier.
- Never place additional items on the seat that can increase the total weight registered by the weight-sensing mat and can cause injury in a crash. ■

Front airbags

Description of front airbags

The airbag system can provide supplemental protection to properly restrained front seat occupants.



Fig. 136 Location of driver airbag: in steering wheel

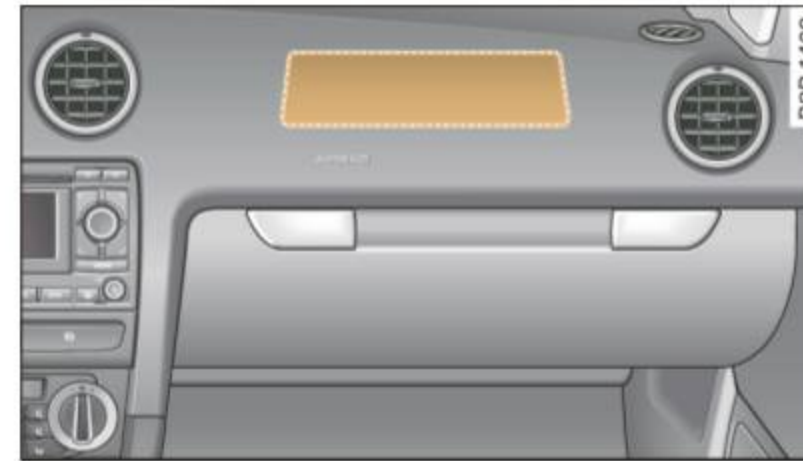

Fig. 137 Location of front passenger's airbag: in the instrument panel

Your vehicle is equipped with an “Advanced Airbag System” in compliance with United States Federal Motor Vehicle Safety Standard (FMVSS) 208 as applicable at the time your vehicle was manufactured. The safety belts for the front seats have “pretensioners” that help to take slack out of the belt system. The pretensioners are also activated by the electronic control unit for the airbag system.

The front safety belts also have load limiters to help reduce the forces applied to the body in a crash.

The airbag for the driver is in the steering wheel hub ⇒ fig. 136 and the airbag for the front passenger is in the instrument panel ⇒ fig. 137. The general location of the airbags is marked “AIRBAG”.

There is a lot you need to know about the airbags in your vehicle. We urge you to read the detailed information about airbags, safety belts and child safety in this and the other chapters that make up the owner's literature. Please be sure to heed the WARNINGS - they are extremely important for your safety and the safety of your passengers, especially infants and small children.

⚠ WARNING

Never rely on airbags alone for protection.

- Even when they deploy, airbags provide only supplemental protection.

⚠ WARNING (continued)

- Airbag work most effectively when used with properly worn safety belts.
- Therefore, always wear your safety belts and make sure that everybody in your vehicle is properly restrained.

⚠ WARNING

A person on the front passenger seat, especially infants and small children, will receive serious injuries and can even be killed by being too close to the airbag when it inflates.

- Although the Advanced Airbag System in your vehicle is designed to turn off the front passenger airbag if an infant or a small child is on the front passenger seat, nobody can absolutely guarantee that deployment under these special conditions is impossible in all conceivable situations that may happen during the useful life of your vehicle.
- The Advanced Airbag System can deploy in accordance with the “low risk” option under the U.S. Federal Standard if a child that is heavier than the typical one-year old child is on the front passenger seat and the other conditions for airbag deployment are met.
- Accident statistics have shown that children are generally safer in the rear seat area than in the front seating position.
- For their own safety, all children, especially 12 years and younger, should always ride in the back properly restrained for their age and size. ■

Advanced front airbag system

Your vehicle is equipped with a front Advanced Airbag System in compliance with United States Federal Motor Vehicle Safety Standard 208 as applicable at the time your vehicle was manufactured.

The front Advanced Airbag System supplements the safety belts to provide additional protection for the driver's and front passenger's heads and upper bodies in frontal crashes. The airbags inflate only in frontal impacts when the vehicle deceleration is high enough.

The front Advanced Airbag System for the front seat occupants is not a substitute for your safety belts. Rather, it is part of the overall occupant restraint system in your vehicle. Always remember that the airbag system can only help to protect you, if you are sitting upright, wearing your safety belt and wearing it properly. This is why you and your passengers must always be properly restrained, not just because the law requires you to be.

The Advanced Airbag System in your vehicle has been certified to meet the “low risk” requirements for 3 and 6 year-old children on the passenger side and very small adults on the driver side. The low risk deployment criteria are intended to help reduce the risk of injury through interaction with the front airbag that can occur, for example, by being too close to the steering wheel and instrument panel when the airbag inflates.

In addition, the system has been certified to comply with the “suppression” requirements of the Safety Standard, to turn off the front airbag for infants 12 months old and younger who are restrained on the front passenger seat in child restraints that are listed in the Standard ⇒ *page 169*.

“Suppression” requires the front airbag on the passenger side to be turned off if:

- a child up to about one year of age is restrained on the front passenger seat in one of the rear-facing or forward-facing infant restraints listed in Federal Motor Vehicle Safety Standard 208 with which the Advanced Airbag System in your vehicle was certified. For a listing of the child restraints that were used to certify your vehicle's compliance with the US Safety Standard ⇒ *page 169*,
- weight less than a threshold level stored in the control unit is detected on the front passenger seat.

When a person is detected on the front passenger seat, weighing more than the total weight of a child that is about 1 year old

restrained in one of the rear-facing or forward-facing infant restraints (listed in Federal Motor Vehicle Safety Standard 208 with which the Advanced Airbag System in your vehicle was certified), the front airbag on the passenger side may or may not deploy.

The **PASSENGER AIR BAG OFF** light comes on when the electronic control unit detects a total weight on the front passenger seat that requires the front airbag to be turned off. If the **PASSENGER AIR BAG OFF** light does not come on, the front airbag on the passenger side has not been turned off by the control unit and can deploy if the control unit senses an impact that meets the conditions stored in its memory.

If the total weight on the front passenger seat is more than that of a typical 1 year-old, but less than the weight of a small adult, the front airbag on the passenger side may deploy (the **PASSENGER AIR BAG OFF** light does not come on).

For example, the airbag may deploy if:

- a small child that is heavier than a typical 1 year-old child is on the front passenger seat (regardless of whether the child is in one of the child safety seats listed ⇒ *page 169*),
- a child who has outgrown child restraints is on the front passenger seat.

If the front passenger airbag is turned off, the **PASSENGER AIR BAG OFF** light in the center of the instrument panel will come on and stay on.

The front airbag on the passenger side may *not* deploy (the **PASSENGER AIR BAG OFF** light does not illuminate and stay lit) if:

- a small adult or teenager is on the front passenger seat
- a passenger who is not sitting upright with their back against a non-reclined backrest with their feet on the vehicle floor in front of the seat is on the front passenger seat.

If the front passenger airbag deploys, the Federal Standard requires the airbag to meet the “low risk” deployment criteria to help reduce the risk of injury through interaction with the airbag. “Low risk”

deployment occurs in those crashes that take place at lower decelerations as defined in the electronic control unit ⇒ *page 156*.

Always remember: Even though your vehicle is equipped with Advanced Airbags, the safest place for children is properly restrained on the back seat. Please be sure to read the important information in the sections that follow and be sure to heed all of the WARNINGS.

WARNING

To reduce the risk of injury when an airbag inflates, always wear safety belts properly.

- If you are unrestrained, leaning forward, sitting sideways or out of position in any way, your risk of injury is much higher.
- You will also receive serious injuries and could even be killed if you are up against the airbag or too close to it when it inflates - even with an Advanced Airbag ⇒ *page 145*.

WARNING

A child in a rearward-facing child safety seat installed on the front passenger seat will be seriously injured and can be killed if the front airbag inflates - even with an Advanced Airbag System.

- Although the Advanced Airbag System in your vehicle is designed to turn off the front airbag when a rearward-facing child restraint has been installed on the front passenger seat, nobody can absolutely guarantee that deployment is impossible in all conceivable situations that may happen during the useful life of your vehicle.
- The inflating airbag will hit the child safety seat or infant carrier with great force and will smash the child safety seat and child against the backrest, center armrest, door, or roof.
- Always install rearward-facing child restraints in the back seat.
- If you must install a rearward facing child safety seat on the front passenger seat because of exceptional circumstances and the **PASSENGER AIR BAG OFF** light does not come on and stay on, ►

⚠ WARNING (continued)

immediately install the rear-facing child safety seat in a rear seating position and have the airbag system inspected by your authorized Audi dealer.

⚠ WARNING

If, in exceptional circumstances, you must install a forward-facing child restraint on the front passenger's seat:

- Always make sure the forward-facing seat has been designed and certified by its manufacturer for use on a front seat with a passenger front and side airbag.
- Never put the forward-facing child restraint up against or very near the instrument panel.
- Always move the passenger seat into its rearmost position in the seat's fore and aft adjustment range, as far away from the airbag as possible, before installing the forward-facing child restraint. The backrest must be adjusted to an upright position.
- Make sure that the **PASSENGER AIR BAG OFF** light comes on and stays on all the time whenever the ignition is switched on. ■

Advanced Airbag System components

The front passenger seat in your vehicle has a lot of very important parts of the Advanced Airbag System in it. These parts include the weight-sensing mat, sensors, wiring, brackets, and more. The function of the system in the front passenger seat is checked by the electronic control unit when the ignition is on. The control unit monitors the Advanced Airbag System and turns the airbag indicator light on when a malfunction in the system components is detected. The function of the airbag indicator light is described in greater detail below. Because the front passenger seat contains important parts of the Advanced Airbag System, you must take care to prevent it from being

damaged. Damage to the seat may prevent the Advanced Airbag for the front passenger seat from doing its job in a crash.

The front Advanced Airbag System consists of the following:

- Crash sensors in the front of the vehicle that measure vehicle acceleration/deceleration to provide information to the Advanced Airbag System about the severity of the crash.
- An electronic control unit, with integrated crash sensors for front and side impacts. The control unit “decides” whether to fire the front airbags based on the information received from the crash sensors. The control unit also “decides” whether the safety belt pretensioners should be activated.
- An Advanced Airbag with gas generator for the driver inside the steering wheel hub.
- An Advanced Airbag with gas generator inside the instrument panel for the front passenger.
- A weight-sensing mat under the upholstery padding of the front passenger seat cushion that measures the total weight on the seat. The information registered is sent continuously to the electronic control unit to regulate deployment of the front Advanced Airbag on the passenger side.
- An airbag monitoring system and indicator light in the instrument cluster ⇒ *page 156*.
- The **PASSENGER AIR BAG OFF** light comes on and stays on in the center of the instrument panel ⇒ *page 157*, fig. 139 and tells you when the front Advanced Airbag on the passenger side has been turned off.
- A sensor below the safety belt latch for the front seat passenger to measure the tension on the safety belt. The tension on the safety belt and the weight registered by the weight-sensing mat help the control unit “decide” whether the front airbag for the front passenger seat should be turned off or not ⇒ *page 147*, “Child restraints on the front seat – some important things to know”.

- A sensor in the safety belt latch for the driver and for the front seat passenger that senses whether that safety belt is latched or not and transmits this information to the electronic control unit.

WARNING

Damage to the front passenger seat can prevent the front airbag from working properly.

- Improper repair or disassembly of the front passenger and driver seat will prevent the Advanced Airbag System from functioning properly.
- Repairs to the front passenger seat must be performed by qualified and properly trained workshop personnel.
- Never remove the front passenger or driver seat from the vehicle.
- Never remove the upholstery from the front passenger seat.
- Never disassemble or remove parts from the seat or disconnect wires from it.
- Never carry sharp objects in your pockets or place them on the seat. If the weight-sensing mat in the passenger seat is punctured it cannot work properly.
- Never carry things on your lap or carry objects on the passenger seat. Such items can increase the weight registered by the weight-sensing mat and send the wrong information to the airbag control unit.
- Never store items under the front passenger seat. Parts of the Advanced Airbag System under the passenger seat could be damaged, preventing them and the airbag system from working properly.
- Never place seat covers or replacement upholstery that have not been specifically approved by Audi on the front seats.
- Seat covers can prevent the Advanced Airbag System from recognizing child restraints or occupants on the front passenger seat and prevent the side airbag in the seat backrest from deploying properly.

WARNING (continued)

- Never use cushions, pillows, blankets or similar items on the front passenger seat. The additional padding will prevent the weight-sensing mat in the seat from accurately registering the child restraint or person on the seat and prevent the Advanced Airbag System from functioning properly.
- If you must use a child restraint on the front passenger seat and the child restraint manufacturer's instructions require the use of a towel, foam cushion or something else to properly position the child restraint, make certain that the PASSENGER AIR BAG OFF light comes on and stays on whenever the child restraint is installed on the front passenger seat.
- If the PASSENGER AIR BAG OFF light does not come on and stay on, immediately install child restraint in a rear seating position and have the airbag system inspected by your authorized Audi dealer. ■

How the Advanced Airbag System components work together

The front Advanced Airbag System and the side airbags supplement the protection offered by the front three-point safety belts with pretensioners and load limiters and the adjustable head restraints to help reduce the risk of injury in a wide range of accident and crash situations. Be sure to read the important information about safety and heed the WARNINGS in this chapter.

Deployment of the Advanced Airbag System and the activation of the safety belt pretensioners depend on the deceleration measured by the crash sensors and registered by the electronic control unit. Crash severity depends on speed and deceleration as well as the mass and stiffness of the vehicle or object involved in the crash.

When the electronic control unit registers a low severity crash and the safety belt is being used, the airbag will not deploy. If the safety ►

belt is not being used, the first stage deploys, followed by the second stage after a much later time in the crash sequence.

If the electronic control unit registers a crash of medium severity, the first stage of the airbag deploys followed by the second stage at a much later time in the crash sequence - regardless of whether the safety belt is being used or not. In higher severity crashes as registered by the electronic control unit, both the first and second stages deploy almost at the same time.

On the passenger side, regardless of safety belt use, the airbag will be turned off if the weight on the passenger seat is less than the amount programmed in the electronic control unit. The front airbag on the passenger side will also be turned off if one of the child safety seats that has been certified under Federal Motor Vehicle Safety Standard 208 has been recognized on the seat. The **PASSENGER AIR BAG OFF** light comes on and stays on to tell you when the front Advanced Airbag on the passenger side has been turned off ⇒ *page 147*, "Child restraints on the front seat - some important things to know".

WARNING

To reduce the risk of injury when an airbag inflates, always wear safety belts properly.

- If you are unrestrained, leaning forward, sitting sideways or out of position in any way, your risk of injury is much higher.
- You will also receive serious injuries and could even be killed if you are up against the airbag or too close to it when it inflates - even with an Advanced Airbag ⇒ *page 145*. ■

More important things to know about front airbags



Fig. 138 Inflated front airbags

Safety belts are important to help keep front seat occupants in the proper seated position so that airbags can unfold properly and provide supplemental protection in a frontal collision.

The front airbags are designed to provide additional protection for the chest and face of the driver and the front seat passenger when:

- safety belts are worn properly,
- the seats have been positioned so that the occupant is properly seated as far as possible from the airbag,
- and the head restraints have been properly adjusted.

Because airbags inflate in the blink of an eye with great force, things you have on your lap or have placed on the seat could become dangerous projectiles, and be pushed into you if the airbag inflates.

When an airbag deploys, fine dust is released. This is normal and is not caused by a fire in the vehicle. This dust is made up mostly of a powder used to lubricate the airbags as they deploy. It could irritate skin.

It is important to remember that while the supplemental airbag system is designed to reduce the likelihood of serious injuries, other injuries, for example swelling, bruising and minor abrasions, can also happen when airbags inflate. Airbags do not protect the arms or the ►

lower parts of the body. Front airbags supplement the three-point safety belts only in some frontal collisions in which the vehicle deceleration is high enough to deploy the airbags.

Front airbags will not deploy:

- if the ignition is switched off when a crash occurs,
- in side collisions,
- in rear-end collisions,
- in rollovers,
- when the crash deceleration measured by the airbag system is less than the minimum threshold needed for airbag deployment as registered by the electronic control unit.

The front passenger airbag also will not deploy:

- when the front passenger seat is not occupied,
- when the weight on the front passenger seat as sensed by the Advanced Airbag System indicates that the front airbag on the passenger side has to be turned off by the electronic control unit (the **PASSENGER AIR BAG OFF** light comes on and stays on).

WARNING

Sitting in the wrong position can increase the risk of serious injury in crashes.

- To reduce the risk of injury when the airbags inflate, the driver and passengers must always sit in an upright position, must not lean against or place any part of their body too close to the area where the airbags are located.
- Occupants who are unbelted, out of position or too close to the airbag can be seriously injured by an airbag as it unfolds with great force in the blink of an eye ⇒ *page 147*.

WARNING

A child in a rearward-facing child safety seat installed on the front passenger seat will be seriously injured and can be killed if the front airbag inflates - even with an Advanced Airbag System.

- The inflating airbag will hit the child safety seat or infant carrier with great force and will smash the child safety seat and child against the backrest, center armrest, door or roof.
- Always install rear-facing child safety seats on the rear seat.
- If you must install a rearward facing child safety seat on the front passenger seat because of exceptional circumstances and the **PASSENGER AIR BAG OFF** light does not come on and stay on, immediately install the rear-facing child safety seat in a rear seating position and have the airbag system inspected by your authorized Audi dealer.

WARNING

Objects between you and the airbag will increase the risk of injury in a crash by interfering with the way the airbag unfolds or by being pushed into you as the airbag inflates.

- Never hold things in your hands or on your lap when the vehicle is in use.
- Never transport items on or in the area of the front passenger seat. Objects could move into the area of the front airbags during braking or other sudden maneuvers and become dangerous projectiles that can cause serious personal injury if the airbags inflate.
- Never place or attach accessories or other objects (such as cup holders, telephone brackets, large, heavy or bulky objects) on the doors, over or near the area marked "AIRBAG" on the steering wheel, instrument panel, seat backrests or between those areas and yourself. These objects could cause injury in a crash, especially when the airbags inflate.

 **WARNING** (continued)

- Never recline the front passenger's seat to transport objects. Items can also move into the area of the side airbag or the front airbag during braking or in a sudden maneuver. Objects near the airbags can become projectiles and cause injury, particularly when the seat is reclined.

 **WARNING**

The fine dust created when airbags deploy can cause breathing problems for people with a history of asthma or other breathing conditions.

- To reduce the risk of breathing problems, those with asthma or other respiratory conditions should get fresh air right away by getting out of the vehicle or opening windows or doors.
- If you are in a collision in which airbags deploy, wash your hands and face with mild soap and water before eating.
- Be careful not to get the dust into your eyes, or into any cuts or scratches.
- If the residue should get into your eyes, flush them with water. ■

Monitoring the Advanced Airbag System

Airbag monitoring indicator light

Two separate indicators monitor the function of the Advanced Airbag System: the airbag monitoring indicator light and the **PASSENGER AIR BAG OFF** light.

The Advanced Airbag System (including the electronic control unit, sensor circuits and system wiring) is monitored continuously to make sure that it is functioning properly whenever the ignition is on. Each

time you turn on the ignition, the airbag monitoring indicator light  will come on for a few seconds (self diagnostics).

The system must be inspected when the indicator light :

- does not come on when the ignition is switched on,
- does not go out a few seconds after you have switched on the ignition, or
- comes on while driving.

If an airbag system malfunction is detected, the indicator light will first start flashing to catch the driver's attention and then stay on continuously to serve as a constant reminder to have the system inspected immediately.

If a malfunction occurs that turns the front airbag on the passenger side off, the **PASSENGER AIR BAG OFF** light will come on and stay on whenever the ignition is on.

 **WARNING**

An airbag system that is not functioning properly cannot provide supplemental protection in a frontal crash.

- If the airbag indicator light comes on, it means that there may be something wrong with the Advanced Airbag System. It is possible that the airbag will inflate when it is not supposed to, or will not inflate when it should.
- Have the airbag system inspected immediately by your authorized Audi dealer. ■

PASSENGER AIR BAG OFF light



Fig. 139 Section from the center console: PASSENGER AIR BAG OFF light

The **PASSENGER AIR BAG OFF** light is located in the center console ⇒ fig. 139.

The **PASSENGER AIR BAG OFF** light will come on and stay on to tell you when the front Advanced Airbag on the passenger side has been turned off by the electronic control unit. Each time you turn on the ignition, the **PASSENGER AIR BAG OFF** light will flash for a few seconds and:

- will stay on if the front passenger seat is not occupied,
- will stay on if there is a small child or child restraint on the front passenger seat,
- will go out if the front passenger seat is occupied by an adult as registered by the weight-sensing mat.

The **PASSENGER AIR BAG OFF** light must come on and stay on if the ignition is on and

- a car bed has been installed on the front seat, or
- a rearward-facing child restraint has been installed on the front passenger seat, or
- a forward-facing child restraint has been installed on the front passenger seat, or
- the weight registered on the front passenger seat is equal to or less than the combined weight of a typical 1 year-old restrained in

one of the rear-facing or forward-facing infant restraints listed in Federal Motor Vehicle Safety Standard 208 with which the Advanced Airbag System in your vehicle was certified.

If the front passenger seat is not occupied, the front airbag will not deploy, and the **PASSENGER AIR BAG OFF** light will stay on. Never install a rearward-facing child restraint on the front passenger seat, the safest place for a child in any kind of child restraint is at one of the seating positions on the rear seat ⇒ *page 147*, “Child restraints on the front seat – some important things to know” and ⇒ *page 167*, “Child Safety”.

If the PASSENGER AIR BAG OFF light comes on when one of the conditions listed above is met, be sure to check the light regularly to make certain that the **PASSENGER AIR BAG OFF** light stays on continuously whenever the ignition is on. If the **PASSENGER AIR BAG OFF** light does not appear on and does not stay on all the time, stop as soon as it is safe to do so and

- reactivate the system by turning the ignition off and then turning it on again;
- remove and reinstall the child restraint. Make sure that the child restraint is properly installed and that the safety belt for the front passenger seat has been correctly routed through the child restraint as described in the child restraint manufacturer's instructions;
- make sure that the convertible locking feature on the safety belt for the front passenger seat has been activated and that the safety belt has been pulled tight. The belt must not be loose or have loops of slack so that the sensor below the safety belt latch on the seat can do its job ⇒ *page 177*.
- make sure that things that may increase the weight of the child and child safety seat are not being transported on the front passenger seat;
- make sure that the safety belt tension sensor is not blocked. Shake the safety belt latch on the front passenger seatback and forth;
- If a strap or tether is being used to tie the child safety seat to the front passenger seat, make sure that it is not so tight that it causes ►

the weight-sensing mat to measure more weight than is actually on the seat.

If the **PASSENGER AIR BAG OFF** light still does not come on and does not stay on continuously (when the ignition is switched on),

- take the child restraint off the front passenger seat and install it properly at one of the rear seat positions. Have the airbag system inspected by your authorized Audi dealer immediately.
- move the child to a rear seat position and make sure that the child is properly restrained in a child restraint that is appropriate for its size and age.

The **PASSENGER AIR BAG OFF** light should NOT come on when the ignition is on and an adult is sitting in a proper seating position on the front passenger seat. If the **PASSENGER AIR BAG OFF** light comes on and stays on or flashes for about 5 seconds while driving, under these circumstances, make sure that:

- the adult on the front passenger seat is properly seated on the center of the seat cushion with his or her back up against the backrest and the backrest is not reclined ⇒ *page 126*, “Proper seating position for the driver”,
- the adult is not taking weight off the seat by holding on to the passenger assist handle above the front passenger door or supporting their weight on the armrest,
- the safety belt is being properly worn and that there is not a lot of slack in the safety belt webbing,
- accessory seat covers or cushions or other things that may cause an incorrect reading or impression on the weight-sensing mat under the upholstery of the seat have been removed from the front passenger seat,
- a safety belt extender has not been left in the safety belt latch for the front passenger seat.

In addition to the **PASSENGER AIR BAG OFF** light in the center of the instrument panel, the message **PASSENGER AIR BAG OFF** or **PASSENGER AIR BAG ON** will briefly appear in the instrument cluster

display. This is to inform the driver of the current front passenger airbag status. ■

Important safety instructions on monitoring the Advanced Airbag System

WARNING

An airbag system that is not functioning properly cannot provide supplemental protection in a frontal crash.

- If the airbag indicator light comes on, it means that there may be something wrong with the Advanced Airbag System. It is possible that the airbag will inflate when it is not supposed to, or will not inflate when it should.
- Have the airbag system inspected immediately by your authorized Audi dealer.

WARNING

If the front airbag inflates, a child without a child restraint, or in a rearward-facing child safety seat, or in a forward-facing child restraint that has not been properly installed will be seriously injured and can be killed.

- Even though your vehicle is equipped with an Advanced Airbag System, make certain that all children, especially 12 years and younger, always ride on the back seat properly restrained for their age and size.
- Always install forward or rear-facing child safety seats on the rear seat – even with an Advanced Airbag System.
- If you must install a rearward-facing child safety seat on the front passenger seat because of exceptional circumstances and the **PASSENGER AIR BAG OFF** light does not appear and stay on, immediately install the rear-facing child safety seat in a rear

 **WARNING** (continued)

seating position and have the airbag system inspected by your authorized Audi dealer.

- A tight tether or other strap on a rearward-facing child restraint attached to the front passenger seat can put too much pressure on the weight-sensing mat in the seat and register more weight than is actually on the seat. The heavier weight registered can make the system work as though an adult were on the seat and deploy the Advanced Airbag when it must be suppressed causing serious or even fatal injury to the child.
- If, in exceptional circumstances, you must install a forward-facing child restraint on the front passenger seat, always move the seat into its rearmost position in the seat's fore and aft adjustment range, as far away from the airbag as possible. The backrest must be adjusted to an upright position. Make sure that the PASSENGER AIR BAG OFF light comes on and stays on all the time whenever the ignition is switched on.

 **WARNING**

- If the PASSENGER AIR BAG OFF light does not go out when an adult is sitting on the front passenger seat after taking the steps described above, make sure the adult is properly seated and restrained at one of the rear seating positions.
- Have the airbag system inspected by your authorized Audi dealer before transporting anyone on the front passenger seat.

 **Tips**

If the weight-sensing mat in the front passenger seat detects an empty seat, the front airbag on the passenger side will be turned off, and the **PASSENGER AIR BAG OFF** light will stay on. ■

Repair, care and disposal of the airbags

Parts of the airbag system are installed at many different places on your Audi. Installing, removing, servicing or repairing a part in an area of the vehicle can damage a part of an airbag system and prevent that system from working properly in a collision.

There are some important things you have to know to make sure that the effectiveness of the system will not be impaired and that discarded components do not cause injury or pollute the environment.

 **WARNING**

Improper care, servicing and repair procedures can increase the risk of personal injury and death by preventing an airbag from deploying when needed or deploying an airbag unexpectedly:

- Never cover, obstruct, or change the steering wheel horn pad or airbag cover or the instrument panel or modify them in any way.
- Never attach any objects such as cup holders or telephone mountings to the surfaces covering the airbag units.
- For cleaning the horn pad or instrument panel, use only a soft, dry cloth or one moistened with plain water. Solvents or cleaners could damage the airbag cover or change the stiffness or strength of the material so that the airbag cannot deploy and protect properly.
- Never repair, adjust, or change any parts of the airbag system.
- All work on the steering wheel, instrument panel, front seats or electrical system (including the installation of audio equipment, cellular telephones and CB radios, etc.) must be performed by a qualified technician who has the training and special equipment necessary.
- For any work on the airbag system, we strongly recommend that you see your authorized Audi dealer or qualified workshop.
- Never modify the front bumper or parts of the vehicle body. ►

⚠ WARNING (continued)

- **Always make sure that the side airbag can inflate without interference:**
 - **Never install seat covers or replacement upholstery over the front seatbacks that have not been specifically approved by Audi.**
 - **Never use additional seat cushions that cover the areas where the side airbags inflate.**
 - **Damage to the original seat covers or to the seam in the area of the side airbag module must always be repaired immediately by an authorized Audi dealer.**
- **The airbag system can be activated only once. After an airbag has inflated, it must be replaced by an authorized Audi dealer or qualified technician who has the technical information, training and special equipment necessary.**
- **The airbag system can be deployed only once. After an airbag has been deployed, it must be replaced with new replacement parts designed and approved especially for your Audi model version. Replacement of complete airbag systems or airbag components must be performed by qualified workshops only. Make sure that any airbag service action is entered in your Audi Warranty & Maintenance booklet under *AIRBAG REPLACEMENT RECORD*. ■**

Other things that can affect Advanced Airbag performance

Changing the vehicle's suspension system can change the way that the Advanced Airbag System performs in a crash. For example, using tire-rim combinations not approved by Audi, lowering the vehicle, changing the stiffness of the suspension, including the springs, suspension struts, shock absorbers etc. can change the forces that are measured by the airbag sensors and sent to the electronic control unit. Some suspension changes can, for example, increase the force

levels measured by the sensors and make the airbag system deploy in crashes in which it would not deploy if the changes had not been made. Other kinds of changes may reduce the force levels measured by the sensors and prevent the airbag from deploying when it should.

The sensors in the safety belt buckle for the driver and front passenger seat tell the electronic control module if the safety belt is latched or not. If the safety belt is being used, the front airbag will deploy at a slightly higher rate of vehicle deceleration than if the safety belt is not being used. Therefore, in a particular collision, it is possible that an airbag will not deploy at a seating position where the safety belt is being used but will inflate at the position where the safety belt is not being used. It is important that nothing interfere with the safety belt buckles so that the sensors can send the correct information about safety belt use to the electronic control unit.

⚠ WARNING

Changing the vehicle's suspension including use of unapproved tire-rim combinations can change Advanced Airbag performance and increase the risk of serious personal injury in a crash.

- **Never install suspension components that do not have the same performance characteristics as the components originally installed on your vehicle.**
- **Never use tire-rim combinations that have not been approved by Audi.**

⚠ WARNING

Items stored between the safety belt buckle and the center console can cause the sensors in the buckle to send the wrong information to the electronic control module and prevent the Advanced Airbag System from working properly.

- **Always make sure that nothing can interfere with the safety belt buckles and that they are not obstructed.**

For the sake of the environment

Undeployed airbag modules and pretensioners might be classified as Perchlorate Material - special handling may apply, see www.dtsc.ca.gov/hazardouswaste/perchlorate. When the vehicle or parts of the restraint system including airbag modules and safety belts with pretensioners are scrapped, all applicable laws and regulations must be observed. Your authorized Audi dealer is familiar with these requirements and we recommend that you have your dealer perform this service for you. ■

Side airbags

Description of side airbags

The airbag system can provide supplemental protection to properly restrained occupants.



Fig. 140 Side airbag location in the driver's seat

The side airbags are located in the sides of the front seat backrests ⇒ fig. 140 and the rear backrest* facing the doors. They are identified by the word "AIRBAG".

The side airbag system basically consists of:

- the electronic control module and external side impact sensors
- the two side airbags located in the sides of the front backrests

- two rear side airbags (as an ordered *option*)
- the airbag warning light in the instrument cluster.

The airbag system is monitored electronically to make certain that it is functioning properly at all times. Each time you turn on the ignition, the airbag system indicator light will come on for a few seconds (self diagnostics).

The side airbag system supplements the safety belts and can help to reduce the risk of injury to the driver's , front and rear* passenger's upper torso and head on the side of the vehicle that is struck in a side collision. The airbag deploys only in side impacts and only when the vehicle acceleration registered by the control unit is high enough. If this rate is below the reference value programmed into the control unit, the side airbags will not be triggered, even though the car may be badly damaged as a result of the collision. It is not possible to define an airbag triggering range that will cover every possible angle of impact, since the circumstances will vary considerably between one collision and another. Important factors include, for example, the nature (hard or soft) of the impacting object, the angle of impact, vehicle speed, etc. ⇒ *page 163*, "Important safety instructions on the side airbag system".

Aside from their normal safety function, safety belts work to help keep the driver or front passenger in position in the event of a side collision so that the side airbags can provide protection.

The airbag system is *not* a substitute for your safety belt. Rather, it is part of the overall occupant restraint system in your vehicle. Always remember that the side airbag system can only help to protect you if you are wearing your safety belt and wearing it properly. This is another reason why you should always wear your safety belts, not just because the law requires you to do so ⇒ *page 135*, "General notes".

It is important to remember that while the supplemental side airbag system is designed to reduce the likelihood of serious injuries, other injuries, for example, swelling, bruising, and minor abrasions can also be associated with deployed side airbags. Remember too, side airbags will deploy only once and only in certain kinds of accidents - your safety belts are always there to offer protection. ►

Vehicle damage, repair costs or even the lack of vehicle damage are not necessarily an indication of over-sensitive or failed airbag activation. In some collisions, both front and side airbags may inflate. Remember too, that airbags will deploy only once and only in certain kinds of collisions – your safety belts are always there to offer protection in those accidents in which airbags are not supposed to deploy or when they have already deployed.

The side airbag system will not deploy:

- when the ignition is turned off
- in side collisions when the acceleration measured by the sensor is too low
- in front-end collisions
- in rear-end collisions
- in rollovers.

In some types of accidents the front airbags, side curtain airbags and side airbags may be triggered together.

WARNING

- **Safety belts and the airbag system will only provide protection when occupants are in the proper seating position ⇒ page 163.**
- **If the airbag indicator light comes on when the vehicle is being used, have the system inspected immediately by your authorized Audi dealer. The airbag may not work properly when the vehicle acceleration in a side collision is high enough to activate the airbag. ■**

How supplemental side airbags work

Side airbags deploy instantly and can help reduce the risk of upper torso injuries for occupants who are properly restrained.

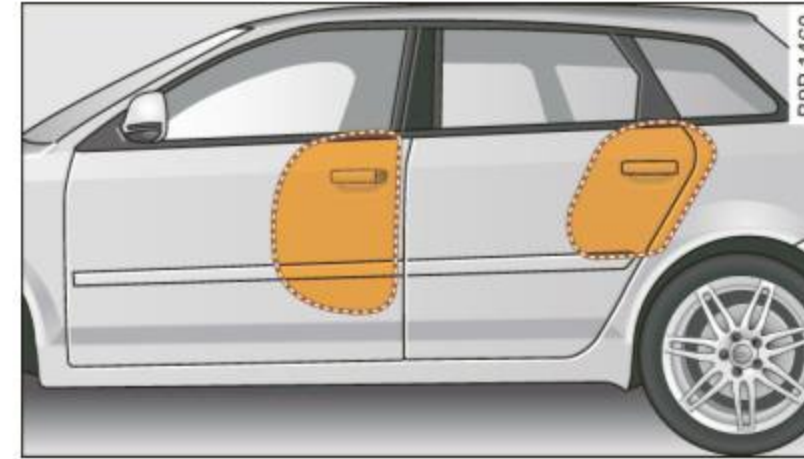

Fig. 141 Inflated side airbags on left side of vehicle, rear side airbag optional equipment

When the system is triggered, the airbag is filled with propellant gas and breaks through a seam in the seat surface area marked "AIRBAG". It expands between the side trim panel and the passenger. In order to help provide this additional protection, the side airbag must inflate within a fraction of a second at very high speed and with great force. The supplemental side airbag could injure you if your seating position is not proper or upright or if items are located in the area where the supplemental side airbag expands. This applies especially to children ⇒ page 167, "Child Safety". Supplemental side airbags inflate between the occupant and the door panel on the side of the vehicle that is struck in certain side collision ⇒ fig. 141.

Although they are not a soft pillow, they can "cushion" the impact and in this way they can help to reduce the risk of injury to the upper part of the body.

A fine dust may develop when the airbag deploys. This is normal and does not mean there is a fire in the vehicle. ■

Important safety instructions on the side airbag system

Airbags are only supplemental restraints. Always properly wear safety belts and ride in a proper seating position.

There is a lot that you and your passengers must know and act accordingly to help the safety belts and airbags do their job to provide supplemental protection.

WARNING

An inflating side airbag can cause serious or fatal injury. Improperly wearing safety belts and improper seating positions increase the risk of serious personal injury and death whenever a vehicle is being used.

- In order to reduce the risk of injury when the supplemental side airbag inflates:
 - Always sit in an upright position and never lean against the area where the supplemental side airbag is located.
 - Never let a child or anyone else rest their head against the side trim panel in the area where the supplemental side airbag inflates.
 - Always make sure that safety belts are worn correctly,
 - Do not let anyone sitting in the front seat put their hand or any other parts of their body out of the window.
- Always make sure that the side airbag can inflate without interference.
 - Never install seat covers or replacement upholstery over the front seatbacks that have not been specifically approved by Audi.
 - Never use additional seat cushions that cover the areas where the side airbags deploy.

WARNING (continued)

- Damage to the original seat covers or to the seam in the area of the side airbag module must always be repaired immediately by an authorized Audi dealer.
- Objects between you and the airbag can increase the risk of injury in an accident by interfering with the way the airbag unfolds or by being pushed into you as the airbag inflates.
 - Never place or attach accessories or other objects (such as cup holders, telephone brackets, or even large, bulky objects) on the doors, over or near the area marked “AIRBAG” on the seat backrests.
 - Such objects and accessories can become dangerous projectiles and cause injury when the supplemental side airbag deploys.
 - Never carry any objects or pets in the deployment space between them and the airbags or allow children or other passengers to travel in this position.
- Always use the built-in coat hooks only for lightweight clothing. Never leave any heavy or sharp-edged objects in the pockets that may interfere with side airbag deployment and can cause personal injury in an accident.
- Always prevent the side airbags from being damaged by heavy objects knocking against or hitting the sides of the seatbacks.
- The airbag system can only be triggered once. If the airbag has been triggered, the system must be replaced by an authorized Audi dealership.
- Damage (cracks, deep scratches etc.) to the original seat covers or to the seam in the area of the side airbag module must always be repaired immediately by an authorized Audi dealer.
- If children are seated improperly, their risk of injury increases in the case of an accident ⇒ *page 167, “Child Safety”*.
- Never attempt to modify any components of the airbag system in any way.

⚠ WARNING (continued)

- **In a side collision, side airbags will not function properly if sensors cannot correctly measure increasing air pressure inside the doors when air escapes through larger, unclosed openings in the door panel.**
 - **Never drive with interior door trim panels removed.**
 - **Never drive when parts have been removed from the inside door panel and the openings they leave have not been properly closed.**
 - **Never drive when loudspeakers in the doors have been removed unless the speaker holes have been properly closed.**
 - **Always make certain that openings are covered or filled if additional speakers or other equipment is installed in the inside door panels.**
 - **Always have work on the doors done by an authorized Audi dealer or qualified workshop. ■**

Side curtain airbags

Description of curtain airbags

The curtain airbags can provide supplemental protection to properly restrained occupants.

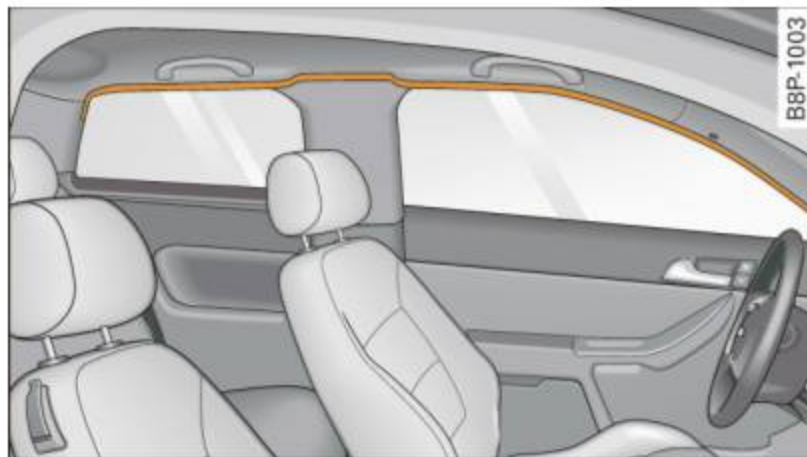

Fig. 142 Curtain airbag, driver's side: side curtain airbag location

The side curtain airbags are located on both sides of the interior above the front and rear side windows ⇒ fig. 142. They are identified by the word “AIRBAG” on the windshield frame and the center roof pillar.

The side curtain airbag system supplements the safety belts and can help to reduce the risk of injury for occupants' heads and upper torso on the side of the vehicle that is struck in a side collision. The side curtain airbag inflates in side impacts and only when the vehicle acceleration registered by the control unit is high enough. If this rate is below the reference value programmed into the control unit, the side airbags will not be triggered, even though the car may be badly damaged as a result of the collision. It is not possible to define an airbag triggering range that will cover every possible angle of impact, since the circumstances will vary considerably between one collision and another. Important factors include, for example, the nature (hard or soft) of the impacting object, the angle of impact, vehicle speed, etc. ⇒ *page 165*.

Aside from their normal safety function, safety belts work to help keep the driver or front passenger in position in the event of a collision so that the side curtain airbags can provide protection.

The airbag system is not a substitute for your safety belt. Rather, it is part of the overall occupant restraint system in your vehicle. Always remember that the airbag system can only help to protect you if you are wearing your safety belt and wearing it properly. This is another reason why you should always wear your safety belts, not just because the law requires you to do so ⇒ *page 135*, “General notes”.

It is important to remember that while the side curtain airbag system is designed to help reduce the likelihood of serious injuries, other injuries, for example, swelling, bruising, and minor abrasions can also be associated with these airbags upon deployment. Remember too, these airbags will deploy only once and only in certain kinds of accidents - your safety belts are always there to offer protection.

The side curtain airbag system basically consists of:

- The electronic control module and external side impact sensors
- The side curtain airbags above the front and rear side windows ▶

- The airbag indicator light in the instrument panel

The airbag system is monitored electronically to make certain it is functioning properly at all times. Each time you turn on the ignition, the airbag system indicator light will come on for a few seconds (self diagnostics).

The side curtain airbag is not activated:

- if the ignition is turned off,
- in side collisions when the acceleration measured by the sensor is too low,
- in rear-end collisions,
- in rollovers.

! WARNING

- Safety belts and the airbag system will only provide protection when occupants are in the proper seating position ⇒ *page 73*, “General recommendations”.
- If the airbag indicator light comes on when the vehicle is being used, have the system inspected immediately by your authorized Audi dealer. The side curtain airbag may not work properly even when the vehicle acceleration in a side collision is high enough to activate the airbag. ■

How side curtain airbags work

Side curtain airbags can work together with side airbags to help reduce the risk of head and upper torso injuries for occupants who are properly restrained.

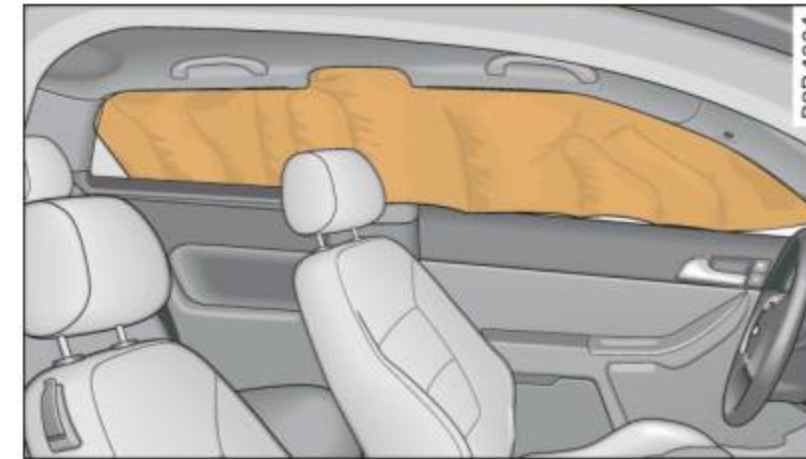

Fig. 143 Illustration of principle: Inflated side curtain airbags on the left side

The side curtain airbags inflate between the occupant and the windows on the side of the vehicle that is struck in a side collision ⇒ *fig. 143*.

When the system is triggered, the side curtain airbag is filled with propellant gas and breaks through a seam above the front and rear side windows identified by the AIRBAG label. In order to help provide this additional protection, the side curtain airbag must inflate within the blink of an eye at very high speed and with great force. The side curtain airbag could injure you if your seating position is not proper or upright or if items are located in the area where the supplemental side curtain airbag inflates. This applies especially to children ⇒ *page 167*.

Although they are not a soft pillow, side curtain airbags can “cushion” the impact and in this way they can help to reduce the risk of injury to the head and the upper part of the body.

A fine dust may develop when the airbag deploys. This is quite normal and does not mean there is a fire in the vehicle. ■

Important safety instructions on the side curtain airbag system

Airbags are only supplemental restraints. Always properly wear safety belts and ride in a proper seating position.

There is a lot that you and your passengers must know and do to help the safety belts and airbags do their job to provide supplemental protection.

WARNING

Improperly wearing safety belts and improper seating positions increase the risk of serious personal injury and death whenever a vehicle is being used.

- Never let occupants place any parts of their bodies in the area from which the side curtain airbags inflate.
- Always make sure that the side curtain airbags can inflate without interference. Unsuitable accessories fitted inside the expansion range of a curtain airbag can dangerously interfere with its function. A deploying head airbag develops enough force to catapult any piece of add-on component out of its path of inflation and into the passenger compartment. An occupant hit by such a projectile can suffer serious injury or death ⇒ *page 302, “Technical Modifications”*.
- Do not swivel the sun visors to the side if you have any objects clipped onto them (for example pens). If the airbag should deploy, you could be injured by these objects.
- Use the built-in coat hooks only for lightweight clothing. Never leave any heavy or sharp-edged objects in the pockets that may interfere with airbag deployment and can cause personal injury in an accident.
- Never use hangers to hang clothing from the hooks.
- Only use factory-installed sun shades or, in the case of shades installed after the vehicle leaves the factory, only Audi roll-up

WARNING (continued)

sunshades may be used ⇒ *page 301, “Additional accessories and parts replacement”*.

- Always sit in proper seating position and wear safety belts while traveling so that the side curtain airbags can help provide protection.
- The airbag system can only be triggered once. If the airbag has been triggered, the system must be replaced by an authorized Audi dealer or qualified workshop.
- Always have work involving the side curtain airbag system, removal and installation of the airbag components, or other repairs performed by a qualified workshop. Otherwise the airbag system may not work correctly.
- Never attempt to modify any components of the airbag system in any way. ■

Child Safety

Important things to know

Introduction

The rear seat is generally the safest place in a collision.

The physical principles of what happens when your vehicle is in a crash apply also to children ⇒ *page 137*, “What happens to occupants not wearing safety belts?”. But unlike adults and teenagers, their muscles and bones are not fully developed. In many respects children are at greater risk of serious injury in crashes than adults.

Because children's bodies are not fully developed, they require restraint systems especially designed for their size, weight, and body structure. Many countries and all states of the United States and provinces of Canada have laws requiring the use of approved child restraint systems for infants and small children.

In a frontal crash at a speed of 20-35 mph (30-56 km/h) the forces acting on a 13-pound (6 kg) infant will be more than 20 times the weight of the child. This means the weight of the child would suddenly be more than 260 pounds (120 kg). Under these conditions, only an appropriate child restraint properly used can reduce the risk of serious injury. Child restraints, like adult safety belts, must be used properly to be effective. Used improperly, they can increase the risk of serious injury in an accident.

Consult the child safety seat manufacturer's instruction to be sure the seat is right for your child's size ⇒ *page 170*, “Important safety instructions for using child safety seats”. Please be sure to read and heed all of the important information and WARNINGS about child safety, Advanced Airbags, and the installation of child restraints in this chapter.

There is a lot you need to know about the Advanced Airbags in your vehicle and how they work when infants and children in child restraints are on the front passenger seat. Because of the large

amount of important information, we cannot repeat it all here. We urge you to read the detailed information in this owner's manual about airbags and the Advanced Airbag System in your vehicle and the very important information about transporting children on the front passenger seat. Please be sure to heed the WARNINGS - they are extremely important for your safety and the safety of your passengers, especially infants and small children.

WARNING

- Accident statistics have shown that children are generally safer in the rear seat area than in the front seating position. Always restrain any child age 12 and under in the rear.
- All vehicle occupants and especially children must be restrained properly whenever riding in a vehicle. An unrestrained or improperly restrained child could be injured by striking the interior or by being ejected from the vehicle during a sudden maneuver or impact. An unrestrained or improperly restrained child is also at greater risk of injury or death through contact with an inflating airbag.
- A suitable child restraint properly installed and used at one of the rear seating positions provides the highest degree of protection for infants and small children in most accident situations.

WARNING

Children on the front seat of any car even with Advanced Airbags can be seriously injured or even killed when an airbag inflates. A child in a rearward-facing child safety seat installed on the front passenger seat will be seriously injured and can be killed if the front airbag inflates.

- The inflating airbag will hit the child safety seat or infant carrier with great force and will smash the child safety seat and child against the backrest, center armrest, or door.

⚠ WARNING (continued)

- Always install rear-facing child safety seats on the rear seat.
- If you must install a rearward facing child safety seat on the front passenger seat in exceptional circumstances and the PASSENGER AIR BAG OFF light does not come on and stay on, immediately install the rear-facing child safety seat in a rear seating position and have the airbag system inspected immediately by your authorized Audi dealer.

⚠ WARNING

If, in exceptional circumstances, you must install a forward-facing child restraint on the front passenger's seat:

- Always make sure the forward-facing seat has been designed and certified by its manufacturer for use on a front seat with a passenger front and side airbag.
- Always follow the manufacturer's instructions provided with the child safety seat or carrier.
- Always move the passenger seat into its rearmost position in the seat's fore and aft adjustment range, as far away from the airbag as possible before installing the child restraint. The backrest must be adjusted to an upright position.
- Always make sure that the PASSENGER AIR BAG OFF light comes on and stays on all the time whenever the ignition is switched on. ■

Advanced front airbag system and children

Your vehicle is equipped with an “Advanced Airbag System” in compliance with United States Federal Motor Vehicle Safety Standard (FMVSS) 208 as applicable at the time your vehicle was manufactured.

The Advanced Airbag system in your vehicle has been certified to meet the “low-risk” requirements for 3- and 6-year old children on the passenger side and small adults on the driver side. The low risk deployment criteria are intended to reduce the risk of injury through interaction with the airbag that can occur, for example, by being too close to the steering wheel and instrument panel when the airbag inflates. In addition, the system has been certified to comply with the “suppression” requirements of the Safety Standard, to turn off the front airbag for infants up to 12 months who are restrained on the front passenger seat in child restraints that are listed in the Standard.

Even though your vehicle is equipped with an Advanced Airbag system, all children, especially those 12 years and younger, should always ride in the back seat properly restrained for their age and size. The airbag on the passenger side makes the front seat a potentially dangerous place for a child to ride. The front seat is not the safest place for a child in a forward-facing child safety seat. It can be a very dangerous place for an infant or a larger child in a rearward-facing seat. ■

Advanced Airbags and the weight-sensing mat in the front seat

The Advanced Airbag System in your vehicle detects the presence of an infant or child in a child restraint on the front passenger seat using the weight-sensing mat in the seat cushion and the sensor below the safety belt latch on the front passenger seat that measures the tension on the safety belt.

The weight-sensing mat measures total weight of the child and the child safety seat and a child blanket on the front passenger seat. The weight on the front passenger seat is related to the design of the child restraint and its “footprint”, the size and shape of the bottom of the child restraint as it sits on the seat. The weight of a child restraint and its “footprint” vary for different kinds of child restraints ►

and for the different models of the same kind of child restraint offered by child restraint manufacturers.

The weight ranges for the individual types, makes and models of child restraints that the NHTSA has specified in the Safety Standard together with the weight ranges of typical infants and typical 1 year-old child have been stored in the control unit of the Advanced Airbag System. When a child restraint is being used on the front passenger seat with a typical 1 year-old child, the Advanced Airbag System compares the weight measured by the weight sensing mat with the information stored in the electronic control unit.

The electronic control unit also registers the tension on the front passenger safety belt. The tension on the safety belt for the front passenger seat will be different for an adult who is properly using the safety belt as compared to the tension on the belt when it is used to attach a child restraint to the seat. The sensor below the latch for the safety belt for the front seat passenger measures the tension on the belt. The input from this sensor is then used with the weight to “decide”, whether there is a child restraint with a typical 1 year-old child on the front passenger seat and whether or not the airbag must be turned off. ■

Child restraints and Advanced Airbags

Regardless of the child restraint that you use, make sure that it has been certified to meet United States Federal Motor Vehicle Safety Standards and has been certified by its manufacturer for use with an airbag. Always be sure that the child restraint is properly installed at one of the rear seating positions. If in exceptional circumstances you must use it on the front passenger seat, carefully read all of the information on child safety and Advanced Airbags and heed all of the applicable WARNINGS. Make certain that the child restraint is correctly recognized by the weight-sensing mat inside the front passenger seat, that the front passenger airbag is turned off and that the airbag status is always correctly signaled by the **PASSENGER AIR BAG OFF** light.

Many types and models of child restraints have been available over the years, new models are introduced regularly incorporating new and improved designs and older models are taken out of production. Child restraints are not standardized. Child restraints of the same type typically have different weights and sizes and different 'foot-prints,' the size and shape of the bottom of the child restraint that sits on the seat, when they are installed on a vehicle seat. These differences make it virtually impossible to certify compliance with the requirements for advanced airbags with each and every child restraint that has ever been sold in the past or will be sold over the course of the useful life of your vehicle.

For this reason, the United States National Highway Traffic Safety Administration has published a list of specific type, makes and models of child restraints that must be used to certify compliance of the Advanced Airbag System in your vehicle with the suppression requirements of Federal Motor Vehicle Safety Standard 208. These child restraints are:

A. Car beds, manufactured on or after September 1, 2004:

- Cosco Dream Ride 02-719

B. Rear facing child restraint systems, manufactured on or after September 1, 2004:

(When the restraint system comes equipped with a removable base, compliance has to be certified with or without the base).

- Britax Handle with Care 191
- Century Assura 4553
- Century Smart Fit 4543
- Cosco Arriva 02727
- Evenflo Discovery Adjust Right 212
- Evenflo First Choice 204
- Graco Infant 8457

C. Forward-facing convertible child restraint systems, manufactured on or after September 1, 2004:

- Britax Roundabout 161
- Century Encore 4612
- Century STE 1000 4416
- Cosco Olympian 02803
- Cosco Touriva 02519
- Evenflo Horizon V 425
- Evenflo Medallion 254
- Safety First Comfort Ride 22-400

WARNING

To reduce the risk of serious injury, make sure that the **PASSENGER AIR BAG OFF** light comes on and stays on whenever a child restraint is installed on the front passenger seat and the ignition is switched on.

- Take the child restraint off the front passenger seat and install it properly at one of the rear seat positions if the **PASSENGER AIR BAG OFF** light does not stay on.
- Have the airbag system inspected by your authorized Audi dealer immediately.

Tips

The child seats listed in categories A to C have been tested by Audi only for the Advanced Airbag function. ■

Important safety instructions for using child safety seats

Correct use of child safety seats substantially reduces the risk of injury in an accident!

As the driver, you are responsible for the safety of everybody in the vehicle, especially children:

- Always use the right child safety seat for each child and always use it properly ⇒ *page 172*.
- Always carefully follow the child safety seat manufacturer's instructions on how to route the safety belt properly through the child safety seat.
- When using the vehicle safety belt to install a child safety seat, you must first activate the convertible locking retractor on the safety belt to prevent the child safety seat from moving ⇒ *page 177*.
- Push the child safety seat down with your full weight to get the safety belt really tight so that the seat cannot move forward or sideways more than one inch (2.5 cm).
- If a strap or tether is being used to tie the child safety seat to the front passenger seat, make sure that it is not so tight that it causes the weight-sensing mat to measure more weight than is actually on the seat.

Always remember: Even though your vehicle is equipped with an Advanced Airbag system, all children, especially those 12 years and younger, should always ride in the back seat properly restrained for their age and size. ►

 **WARNING**

Not using a child safety seat, using the wrong child safety seat or improperly installing a child restraint increases the risk of serious personal injury and death.

- All vehicle occupants and especially children must always be restrained properly whenever riding in a vehicle.
 - An unrestrained or improperly restrained child can be injured or killed by being thrown against the inside of the vehicle or by being ejected from it during a sudden maneuver or impact.
 - An unrestrained or improperly restrained child is at much greater risk of injury or death by being struck by an inflating airbag.
- Commercially available child safety seats are required to comply with U.S. Federal Motor Vehicle Safety Standard (FMVSS) 213 (in Canada CMVSS 213).
 - When buying a child restraint, select one that fits your child and the vehicle.
 - Only use child restraint systems that fully contact the flat portion of the seat cushion. The child restraint must not tip or lean to either side. Audi does not recommend using child safety seats that rest on legs or tube-like frames. They do not provide adequate contact with the seat.
 - Always heed all legal requirements pertaining to the installation and use of child safety seats and carefully follow the instructions provided by the manufacturer of the seat you are using.
- Never allow children under 57 inches (1.45 meters) to wear a normal safety belt. They must always be restrained by a proper child restraint system. Otherwise, they could sustain injuries to the abdomen and neck areas during sudden braking maneuvers or accidents.
- Never let more than one child occupy a child safety seat.

 **WARNING (continued)**

- Never let babies or older children ride in a vehicle while sitting on the lap of another passenger.
 - Holding a child in your arms is never a substitute for a child restraint system.
 - The strongest person could not hold the child with the forces that exist in an accident. The child will strike the interior of the vehicle and can also be struck by the passenger.
 - The child and the passenger can also injure each other in an accident.
- Never install rear-facing child safety seats or infant carriers on the front passenger seat. A child will be seriously injured and can be killed when the passenger airbag inflates – even with an Advanced Airbag System.
- The inflating airbag will hit the child safety seat or infant carrier with great force and will smash the child safety seat and child against the backrest, center armrest, door or roof.
- Always install rear-facing child safety seats or infant carriers on the rear seat.
- Forward-facing child safety seats installed on the front passenger's seat can interfere with the airbag when it inflates and cause serious injury to the child. Always install forward-facing child safety seats on the rear seat.
- If exceptional circumstances require the use of a forward-facing child restraint on the front passenger's seat, the child's safety and well-being require that the following special precautions be taken:
 - Make sure the forward-facing seat has been designed and certified by its manufacturer for use on a front seat with a passenger front and side airbag.
 - Always carefully follow the manufacturer's instructions provided with the child safety seat or carrier.

⚠ WARNING (continued)

- Always move the front passenger seat into the rearmost position of the passenger seat's fore and aft adjustment range, and as far away from the airbag as possible before installing the child restraint.
- Always make sure that nothing prevents the front passenger's seat from being moved to the rearmost position in its fore and aft adjustment range.
- Always make sure that the backrest is in the upright position.
- Always buckle the child safety seat firmly in place even if a child is not sitting in it. A loose child safety seat can fly around during a sudden stop or in a collision.
- Always read and heed all WARNINGS whenever using a child restrained in a vehicle is being used ⇒ *page 135*, "Safety belts", ⇒ *page 145*, "Airbag system" and ⇒ *page 167*, "Child Safety".

⚠ WARNING

To reduce the risk of serious injury, make sure that the **PASSENGER AIR BAG OFF** light comes on and stays on whenever a child restraint is installed on the front passenger seat and the ignition is switched on.

- Take the child restraint off the front passenger seat and install it properly at one of the rear seat positions if the **PASSENGER AIR BAG OFF** light does not stay on.
- Have the airbag system inspected by your authorized Audi dealer immediately.

⚠ WARNING

A child in a child restraint installed with the LATCH lower anchorages or with the standard safety belt on the rear seat may play

⚠ WARNING (continued)

with unused rear seat safety belts and become entangled resulting in serious personal injury and even death.

- Always buckle unused rear seat safety belts out of reach of children in child seats and properly activate the convertible locking retractor so that the child cannot unreel the safety belt from the retractor. ■

Child safety seats

Infant seats

Babies and infants up to about one year old and 20 lbs. or 9 kg need special rearward-facing child restraints that support the back, neck and head in a crash.



Fig. 144 Schematic overview: rearward-facing infant seat, properly installed on the rear seat

- When using the vehicle safety belt to install a child safety seat, you must first activate the convertible locking retractor on the safety belt to prevent the child safety seat from moving ⇒ *page 177* or install the seat using the LATCH attachments. ▶

- Push the child safety seat down with your full weight to get the safety belt really tight so that the seat cannot move forward or sideways more than one inch (2.5 cm).

Infants up to about one year (20 lbs. or 9 kg) are best protected in special infant carriers and child safety seats designed for their age group. Many experts believe that infants and small children should ride only in special restraints in which the child faces the back of the vehicle. These infant seats support the baby's back, neck and head in a crash ⇒ fig. 144.

The airbag on the passenger side makes the front seat a potentially dangerous place for a child to ride. The front seat is not the safest place for a child in a forward-facing child seat. It is a very dangerous place for an infant or a larger child in a rearward-facing seat.

WARNING

Not using a child safety seat, using the wrong child safety seat or improperly installing a child restraint increases the risk of serious personal injury and death in a crash.

- **Never install rear-facing child safety seats or infant carriers on the front passenger seat - even with an Advanced Airbag System. A child will be seriously injured and can be killed when the inflating airbag hits the child safety seat or infant carrier with great force and smashes the child safety seat and child against the backrest, center armrest, door or roof ⇒ page 147, "Child restraints on the front seat - some important things to know".**
- **Always install rear-facing child safety seats or infant carriers on the rear seat.**
- **Never install a rear-facing child restraint in the forward-facing direction. Such restraints are designed for the special needs of infants and very small children and cannot protect them properly if the seat is forward-facing.**
- **If you must install a rearward facing child safety seat on the front passenger seat because of exceptional circumstances and the PASSENGER AIR BAG OFF light does not come on and stay on,**

WARNING (continued)

immediately install the rear-facing child safety seat in a rear seating position and have the airbag system inspected by your Audi dealer.

- **Always read and heed all WARNINGS whenever using a child restrained in a vehicle is being used ⇒ page 135, "Safety belts", ⇒ page 145, "Airbag system" and ⇒ page 167, "Important things to know". ■**

Convertible child safety seats

Properly used convertible child safety seats can help protect toddlers and children over age one who weigh between 20 and 40 lbs. (9 and 18 kg) in a crash.

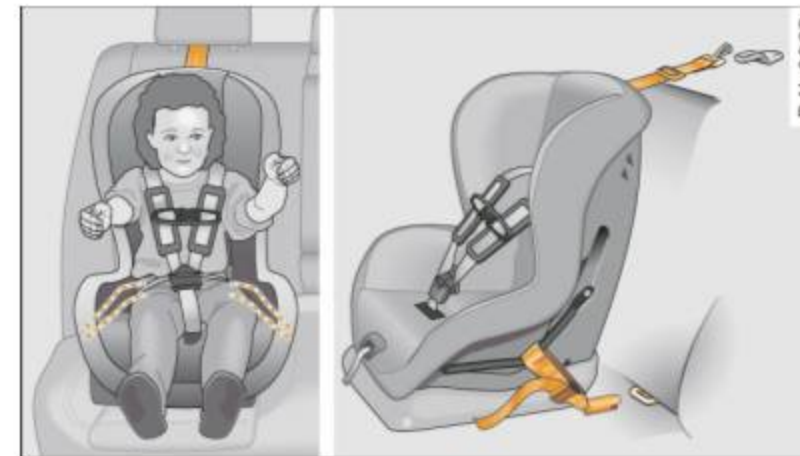

Fig. 145 Schematic overview: installation of the attachments applicable to a LATCH seat

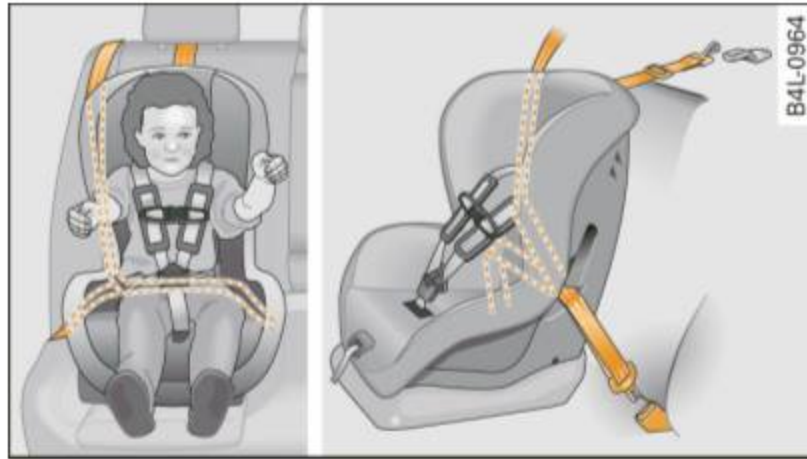

Fig. 146 Schematic overview: installation of the seat using the vehicle's safety belt system

- When using the vehicle safety belt to install a child safety seat, you must first activate the convertible locking feature on the safety belt to prevent the child safety seat from moving ⇒ *page 177* or install the seat using the LATCH attachments.
- Push the child safety seat down with your full weight to get the safety belt really tight so that the seat cannot move forward or sideways more than one inch (2.5 cm) ⇒ *page 177*.
- If the child safety seat is equipped with a tether strap, attach it to the tether anchors ⇒ *page 184*.

A toddler or child is usually too large for an infant restraint if it is more than one year old and weighs more than 20 lbs. (9 kg).

Toddlers and children who are older than one year up to about 4 years old and weigh more than 20 lbs (9 kg) up to 40 lbs. (18 kg) must always be properly restrained in a child safety seat certified for their size and weight ⇒ *page 173*, fig. 145 and ⇒ *page 174*, fig. 146.

The airbag on the passenger side makes the front seat a potentially dangerous place for a child to ride. The front seat is not the safest place for a child in a forward-facing child safety seat. It is a very dangerous place for an infant or a larger child in a rearward-facing seat.

WARNING

Not using a child safety seat, using the wrong child safety seat or improperly installing a child restraint increases the risk of serious personal injury and death in a collision or other emergency situation.

- Children on the front seat of any car, even with Advanced Airbags, can be seriously injured or even killed when an airbag inflates. A child in a rearward-facing child safety seat installed on the front passenger seat will be seriously injured and can be killed if the front airbag inflates – even with an Advanced Airbag System.
- The inflating airbag will hit the child safety seat or infant carrier with great force and will smash the child safety seat and child against the backrest, center armrest, door or roof.
- Always install rear-facing child safety seats on the rear seat.
- If you must install a rearward facing child safety seat on the front passenger seat because of exceptional circumstances and the PASSENGER AIR BAG OFF light does not come on and stay on, immediately install the rear-facing child safety seat in a rear seating position and have the airbag system inspected by your Audi dealer.
- Always read and heed all WARNINGS whenever using a child restrained in a vehicle is being used ⇒ *page 135*, “Safety belts”, ⇒ *page 145*, “Airbag system” and ⇒ *page 167*, “Important things to know”.

WARNING

If exceptional circumstances require the use of a forward-facing child restraint on the front passenger's seat, the child's safety and well-being require that the following special precautions be taken:

⚠ WARNING (continued)

- Make sure the forward-facing seat has been designed and certified by its manufacturer for use on a front seat with a passenger front and side airbag.
- Always follow the manufacturer's instructions provided with the child safety seat or infant carrier.
- Always move the front passenger seat into the rearmost position of the passenger seat's fore and aft adjustment range, and as far away from the airbag as possible before installing the child restraint.
- Always make sure that nothing prevents the front passenger's seat from being moved to the rearmost position in its fore and aft adjustment range.
- Always make sure the backrest is in an upright position.
- Make sure that the PASSENGER AIR BAG OFF light comes on and stays on all the time whenever the ignition is switched on.
- If the light does not stay on, perform the checks ⇒ *page 156*, "Monitoring the Advanced Airbag System".
- Take the child restraint off the front passenger seat and install it properly at one of the rear seat positions if the PASSENGER AIR BAG OFF light does not stay on whenever the ignition is switched on. ■

Booster seats and safety belts

Properly used booster seats can help protect children weighing between about 40 lbs. and 80 lbs. (18 kg and 36 kg) who are less than 4 ft. 9 in. (57 inches/1.45 meters) tall.



Fig. 147 Rear seat: child properly restrained in a booster seat

The vehicle's safety belts alone will not fit most children until they are at least 4 ft. 9 in. (57 inches/1.45 meters) tall and weigh about 80 lbs. (36 kg). Booster seats raise these children up so that the safety belt will pass properly over the stronger parts of their bodies and the safety belt can help protect them in a crash.

- Do not use the convertible locking retractor when using the vehicle's safety belt to restrain a child on a booster seat.
- Always position the shoulder portion of the safety belt midway over the child's shoulder. If you must transport an older child in a booster seat on the front passenger seat, you can use the safety belt height adjustment to help adjust the shoulder portion properly.
- Always make sure that the shoulder portion of the safety belt never rests against or across the child's neck. ►

- Always make sure that the child can properly wear the lap portion of the belt low across the thighs or pelvis and *never* over the stomach or abdomen.

Children up to at least 8 years old (over 40 lbs or 18 kg) are best protected in child safety seats designed for their age and weight. Experts say that the skeletal structure, particularly the pelvis, of these children is not fully developed, and they must not use the vehicle safety belts without a suitable child restraint.

It is usually best to put these children in appropriate booster seats. Be sure the booster seat meets all applicable safety standards.

Booster seats raise the seating position of the child and reposition both the lap and shoulder parts of the safety belt so that they pass across the child's body in the right places. The routing of the belt over the child's body is very important for the child's protection, whether or not a booster seat is used. Children age 12 and under must always ride in the rear seat.

Children who are at least 4 ft. 9 in. (57 inches/1.45 meters) tall can generally use the vehicle's three point lap and shoulder belts. Never use the lap belt portion of the vehicle's safety belt alone to restrain any child, regardless of how big the child is. Always remember that children do not have the pronounced pelvic structure required for the proper function of lap belt portion of the vehicle's three point lap and shoulder belts. The child's safety absolutely requires that a lap belt portion of the safety belt be fastened snugly and as low as possible around the pelvis. Never let the lap belt portion of the safety belt pass over the child's stomach or abdomen.

In a crash, airbags must inflate within a blink of an eye and with considerable force. In order to do its job, the airbag needs room to inflate so that it will be there to protect the occupant as the occupant moves forward into the airbag.

A vehicle occupant who is out of position and too close to the airbag gets in the way of an inflating airbag. When an occupant is too close, he or she will be struck violently and will receive serious or possibly even fatal injury.

In order for the airbag to offer protection, it is important that all vehicle occupants, especially any children, who must be in the front seat because of exceptional circumstances, be properly restrained and as far away from the airbag as possible. By keeping room between the child's body and the front of the passenger compartment, the airbag can inflate completely and provide supplemental protection in certain frontal collisions.

WARNING

Not using a booster seat, using the booster seat improperly, incorrectly installing a booster seat or using the vehicle safety belt improperly increases the risk of serious personal injury and death in a collision or other emergency situation. To help reduce the risk of serious personal injury and/or death:

- Always make sure to position the shoulder portion of the three-point belt over the middle of child's shoulder.
- Never let the shoulder portion of the belt rest against or across the neck, face, chin, or throat of the child.
- Always make sure the lap belt portion of the three-point belt is worn snug and passes as low as possible across the child's pelvis. Never let the belt pass over the soft abdomen.
- Failure to properly route safety belts over a child's body will cause severe injuries in an accident or other emergency situation ⇒ *page 135*.
- The rear side of the booster seat should be positioned as close as possible to the backrest on the vehicle seat. Adjust or remove the rear seat head restraint if it is difficult to install the child seat with the head restraint in place ⇒ *page 78*. Install the head restraint again immediately once the child seat is removed. Driving without head restraints or with head restraints that are not properly adjusted increases the risk of serious or fatal neck injury dramatically.
- Children on the front seat of any car, even with Advanced Airbags, can be seriously injured or even killed when an airbag inflates.

 WARNING (continued)

- Never let a child stand or kneel on any seat, for example the front seat.
- Never let a child ride in the cargo area of your vehicle.
- Always remember that a child leaning forward, sitting sideways or out of position in any way during an accident can be struck by a deploying airbag. This will result in serious personal injury or death.
- If you must install a booster seat on the front passenger seat because of exceptional circumstances the PASSENGER AIR BAG OFF light must come on and stay on, whenever the ignition is switched on.
- If the PASSENGER AIR BAG OFF light does not come on and stay on, perform the checks described ⇒ *page 156*, “Monitoring the Advanced Airbag System”.
- Take the child restraint off the front passenger seat and install it properly at one of the rear seat positions if the PASSENGER AIR BAG OFF light does not stay on whenever the ignition is switched on.
- Always read and heed all WARNINGS whenever using a child restrained in a vehicle is being used ⇒ *page 135*, “Safety belts”, ⇒ *page 145*, “Airbag system” and ⇒ *page 167*, “Important things to know”. ■

Installing a child safety seat

Securing a child safety seat using a safety belt

Safety belts for the rear seats and the front passenger can be locked with the convertible locking retractor to properly secure child safety seats.

The safety belts emergency locking retractors for the rear seats safety belts and for the front passenger’s seat safety belt have a convertible locking retractor for child restraints. The safety belt must be locked so that belt webbing cannot unreel. The retractor can be activated to lock the safety belt and prevent the safety belt webbing from loosening up during normal driving. A child safety seat can only be properly installed when the safety belt is locked so that the child and child safety seat will stay in place.

Always remember: Even though your vehicle is equipped with an Advanced Airbag system, all children, especially those 12 years and younger, should always ride in the back seat properly restrained for their age and size.

 WARNING

Improperly installed child safety seats increase the risk of serious personal injury and death in a collision.

- Always make sure that the safety belt retractor is locked when installing a child safety seat. An unlocked safety belt retractor cannot hold the child safety seat in place during normal driving or in a crash.
- Always buckle the child safety seat firmly in place even if a child is not sitting in it. A loose child safety seat can fly around during a sudden stop or in a collision.
- Always make sure that the rear seat backrest to which the center rear safety belt is attached is securely latched whenever the rear center safety belt is being used to secure a child restraint. ►

 WARNING (continued)

- If the backrest is not securely latched, the child and the child restraint will be thrown forward together with the backrest and will strike parts of the vehicle interior. The child can be seriously injured or killed.
- Never install rear-facing child safety seats or infant carriers on the front passenger seat. A child will be seriously injured and can be killed when the passenger airbag inflates.
- The inflating airbag will hit the child safety seat or infant carrier with great force and will smash the child safety seat and child against the backrest, center armrest, door or roof.
- Always install rear-facing child safety seats or infant carriers on the rear seat.
- Forward-facing child safety seats or infant carriers installed on the front passenger's seat may interfere with the deployment of the airbag and cause serious injury to the child.
- It is safer to install a forward-facing child safety seat on the rear seat.
- Always read and heed all WARNINGS whenever using a child restrained in a vehicle is being used ⇒ *page 167*. Special precautions apply when installing a child safety seat on the front passenger seat ⇒ *page 147*, "Child restraints on the front seat – some important things to know".

 WARNING

Always take special precautions if you must install a forward or rearward-facing child restraint on the front passenger's seat in exceptional situations:

- Whenever a forward or rearward-facing child restraint is installed on the front passenger seat, the PASSENGER AIR BAG OFF light must come on and stay on whenever the ignition is switched on.

 WARNING (continued)

- If the PASSENGER AIR BAG OFF light does not come on and stay on, perform the checks described ⇒ *page 156*, "Monitoring the Advanced Airbag System".
- Take the child restraint off the front passenger seat and install it properly at one of the rear seat positions if the PASSENGER AIR BAG OFF light does not stay on whenever the ignition is switched on.
- Improper installation of child restraints can reduce their effectiveness or even prevent them from providing any protection.
- An improperly installed child restraint can interfere with the airbag as it deploys and seriously injure or even kill the child.
- Always carefully follow the manufacturer's instructions provided with the child safety seat or carrier.
- Never place additional items on the seat that can increase the total weight registered by the weight-sensing mat and can cause injury in a crash.

 WARNING

Forward-facing child restraints:

- Always make sure the forward-facing seat has been designed and certified by its manufacturer for use on a front seat with a passenger front and side airbag.
- Never put the forward-facing child restraint up, against or very near the instrument panel.
- Always move the passenger seat into its rearmost position in the seat's fore and aft adjustment range, as far away from the airbag as possible before installing the forward-facing child restraint. The backrest must be adjusted to an upright position.
- Make sure that the PASSENGER AIR BAG OFF light comes on and stays on all the time whenever the ignition is switched on.

 **WARNING**
Rearward-facing child restraints:

- A child in a rearward-facing child safety seat installed on the front passenger seat will be seriously injured and can be killed if the front airbag inflates - even with an Advanced Airbag System.
- The inflating airbag will hit the child safety seat or infant carrier with great force and will smash the child safety seat and child against the backrest, center armrest, door or roof.
- Always be especially careful if you must install a rearward facing child safety seat on the front passenger seat in exceptional circumstances.
- A tight tether strap on a rearward-facing child restraint attached to the front passenger seat can put too much pressure on the weight-mat in the seat and register a heavier weight in the Advanced Airbag System. The heavier weight registered can make the system work as though an adult were on the seat and deploy the Advanced Airbag when it must be suppressed causing serious or even fatal injury to the child.
- Make sure that the PASSENGER AIR BAG OFF light comes on and stays on all the time whenever the ignition is switched on.
- If the PASSENGER AIR BAG OFF light does not come on and stay on, immediately install the rear-facing child safety seat in a rear seating position and have the airbag system inspected by your Audi dealer. ■

Activating the convertible locking retractor

Use the convertible locking retractor to secure a child restraint.

Always heed the child safety seat manufacturer's instructions when installing a child restraint in your vehicle. To activate the convertible locking retractor:

- Place the child restraint on a seat, preferably on the rear seat.
- Slowly pull the belt **all the way out**.
- Route it around or through the child restraint belt path ⇒ .
- Push the child safety seat down with your full weight to get the safety belt really tight.
- Insert the belt tongue into the buckle for that seating position.
- Guide the safety belt back into the retractor until the belt lies flat and snug on the child safety seat.
- You should hear a "clicking" noise as the belt winds back into the inertia reel. Test the convertible locking retractor by pulling on the belt. You should no longer be able to pull the belt out of the retractor. The convertible locking retractor is now activated.
- Make sure that the red release button is facing away from the child restraint so that it can be unbuckled quickly.
- Pull on the belt to make sure the safety belt is properly tight and fastened so that the seat cannot move forward or sideways more than one inch (2.5 cm).

 **WARNING**

Using the wrong child restraint or an improperly installed child restraint can cause serious personal injury or death in a crash.

- **Always make sure that the safety belt retractor is locked when installing a child safety seat. An unlocked safety belt retractor cannot hold the child safety seat in place during normal driving or in a crash.**

⚠ WARNING (continued)

- Always buckle the child safety seat firmly in place even if a child is not sitting in it. A loose child safety seat can fly around during a sudden stop or in a crash.
- Always make sure the seat backrest to which the child restraint is installed is in an upright position and securely latched into place and cannot fold forward. Otherwise, the seatback with the child safety seat attached to it could fly forward in the event of an accident or other emergency situation.
- Always read and heed all WARNINGS whenever using a child restrained in a vehicle is being used ⇒ *page 167*. Special precautions apply when installing a child safety seat on the front passenger seat ⇒ *page 147*, “Child restraints on the front seat – some important things to know”. ■

Deactivating the convertible locking retractor

The convertible locking retractor for child restraints will be deactivated automatically when the belt is wound all the way back into the retractor.

- Press the red button on the safety belt buckle. The belt tongue will pop out of the buckle.
- Guide the safety belt all the way back into its stowed position.

Always let the safety belt retract completely into its stowed position. The safety belt can now be used as an ordinary safety belt without the convertible locking retractor for child restraints.

If the convertible locking retractor should be activated inadvertently, the safety belt must be unfastened and guided completely back into its stowed position to deactivate this feature. If the convertible

locking retractor is not deactivated, the safety belt will gradually become tighter and uncomfortable to wear.

⚠ WARNING

Improperly installed child safety seats increase the risk of serious personal injury and death in a collision.

- Never unfasten the safety belt to deactivate the convertible locking retractor for child restraints while the vehicle is moving. You would not be restrained and could be seriously injured in an accident.
- Always read and heed all WARNINGS whenever using a child restrained in a vehicle is being used ⇒ *page 167*. Special precautions apply when installing a child safety seat on the front passenger seat ⇒ *page 147*, “Child restraints on the front seat – some important things to know”. ■

LATCH Lower anchorages and tethers for children

Child Restraint System anchors and how are they related to child safety

To provide a simpler and more practicable way to attach the child restraint on the vehicle seat, Federal regulations require special lower anchorages in vehicles and devices on new child restraints to attach to the vehicle anchorages.

The combination of the tether anchorages and the lower anchorages is now generally called the **LATCH** system for “**L**ower **A**nchorages and **T**ethers for **C**hildren.”

Forward-facing child restraints manufactured after September 1, 1999, are required by U.S. federal regulations to comply with new child head movement performance requirements. These new perfor- ▶

mance requirements make a tether necessary on most new child seats.

Installing a child restraint that requires a top tether without one can seriously impair the performance of the child restraint and its ability to protect the child in a collision. Installing a child restraint that requires a top tether without the top tether may be a violation of state law.

Child restraint manufacturers offer LATCH lower anchorages on their child seats with hook-on or push-on connectors attached to adjustable straps.

In addition to the LATCH lower anchorages, these child restraint systems usually require the use of tether straps to help keep the child restraint firmly in place.

WARNING

Improper installation of child restraints will increase the risk of injury and death in a crash.

- Always follow the instructions provided by the manufacturer of the child restraint you intend to install in your vehicle.
- Never install a child restraint without a properly attached top tether strap if the child restraint manufacturer's instructions require the top tether strap to be used.
- Improper use of child restraint LATCH lower anchorage points can lead to injury in a collision. The LATCH lower anchorage points are designed to withstand only those loads imposed by correctly fitted child restraints.
- Never mount two child restraint systems on one LATCH lower anchorage point.
- Never secure or attach any luggage or other item to the LATCH lower anchorages.

Tips

- In Canada, the terms “top tether” with “lower universal anchorages” (or “lower universal anchorage bars”) are used to describe the system.
- In other countries, the term “ISOFIX” is used to describe the lower anchorages. ■

Location

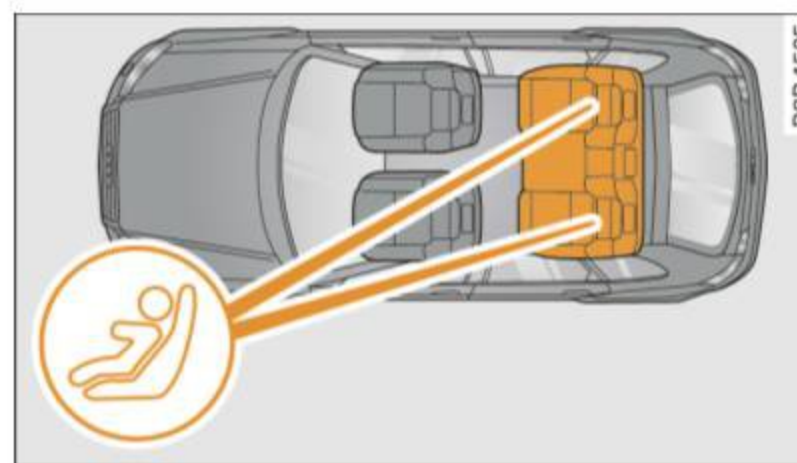

Fig. 148 Schematic overview: LATCH anchorage point locations

The illustration shows the seating locations in your vehicle which are equipped with the lower anchorages system. ■

Description

The lower anchorage positions are marked for quick locating.



Fig. 149 Rear seat-backs: locator buttons for lower anchorages

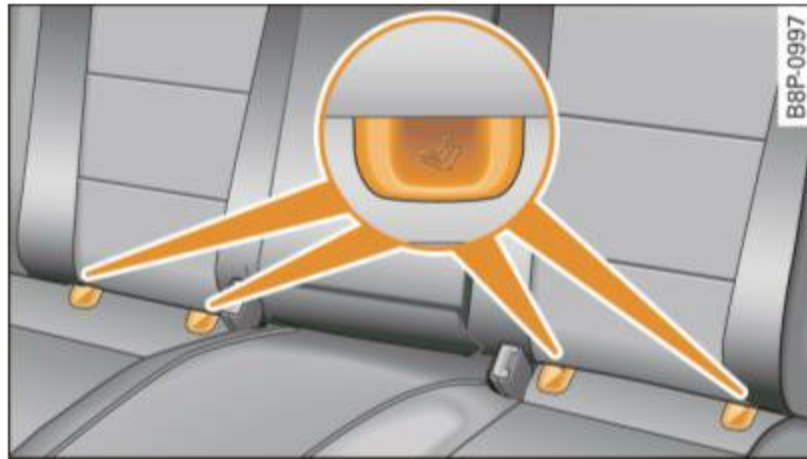

Fig. 150 Rear seats: lower anchorage bracket locations

Attachment locator markers for lower anchorages

Circular locator buttons on the rear seatback indicate the lower anchorage locations on the rear seating positions ⇒ fig. 149.

Lower anchorages

The lower anchorage attachment points are located between the rear seatback and rear seat cushion ⇒ fig. 150.

Lower anchorages secure the child restraint in the seat without using the vehicle's safety belts. Anchorages provide a secure and easy-to-

use attachment and minimize the possibility of improper child restraint installation.

All child restraints manufactured after September 1, 2002, must have lower anchorage attachments for the *LATCH* system.

Remember that the lower anchorage points are only intended for installation and attachment of child restraints specifically certified for use with *LATCH* lower anchorages. Child restraints that are not equipped with the lower anchorage attachments can still be installed in compliance with the child restraint manufacturer's instructions on using vehicle safety belts.

WARNING

Improper use of *LATCH* lower anchorages can cause serious personal injury in an accident.

- Always carefully follow the child restraints manufacturer's instructions for proper installation of the child restraint and proper use of the lower anchorages or safety belts in your vehicle.
- Never secure or attach any luggage or other items to the *LATCH* lower anchorages.
- Always read and heed the important information about child restraints in this chapter and WARNINGS ⇒ page 167, "Child Safety". ■

Installing a child restraint with LATCH lower anchorages

Whenever you install a child restraint always follow the child restraint manufacturer's instructions.

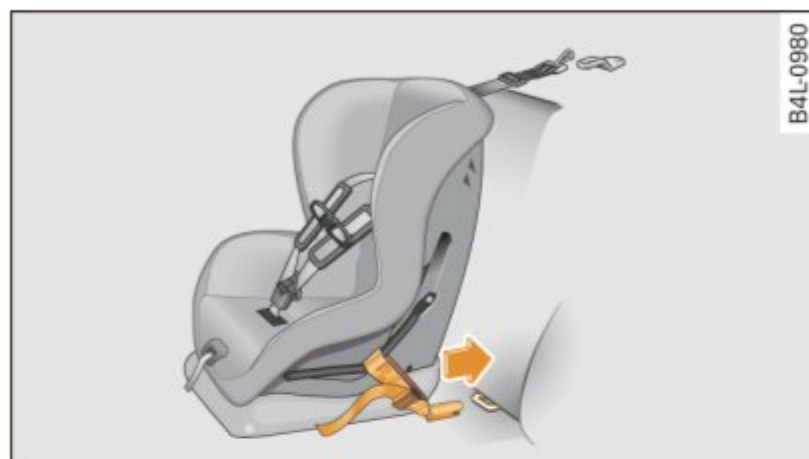

Fig. 151 Lower anchorages: proper mounting

Mounting

- Remove the cover* to access the lower anchorage attachment points.
- Make sure the seatback of the rear seat bench is in the upright position and securely latched in place.
- Attach both hook-on connectors with the spring catch release on the child safety seat onto the LATCH lower anchorage so that the connectors lock into place ⇒ fig. 151.
- Pull on the connector attachments to make sure they are properly attached to the LATCH lower anchorage.
- Pull straps tight following the child restraint manufacturer's instructions.

Releasing

- Loosen the tension on the straps following the child restraint manufacturer's instructions.
- Depress the spring catches to release the anchorage hooks from the lower anchorages.

Remember: Use tether straps to help keep the child restraint firmly in place.

WARNING

Improper use of the LATCH system can increase the risk of serious personal injury and death in an accident.

- These anchors were developed only for child safety seats using the "LATCH" system.
- Never attach other child safety seats, belts or other objects to these anchors.
- Always make sure that you hear a click when latching the seat in place. If you do not hear a click the seat is not secure and could fly forward and hit the interior of the vehicle, or be ejected from the vehicle.

WARNING

Improper installation of child restraints will increase the risk of injury in an accident.

- Always follow the child restraint system manufacturer's instructions for proper installation of the child restraint system and proper use of tether straps as well as the lower anchorages or safety belts in your vehicle.
- Always read and heed the important information and WARNINGS about child safety and the installation of child restraint systems ⇒ page 167, "Child Safety". ■

Tether anchors and tether straps

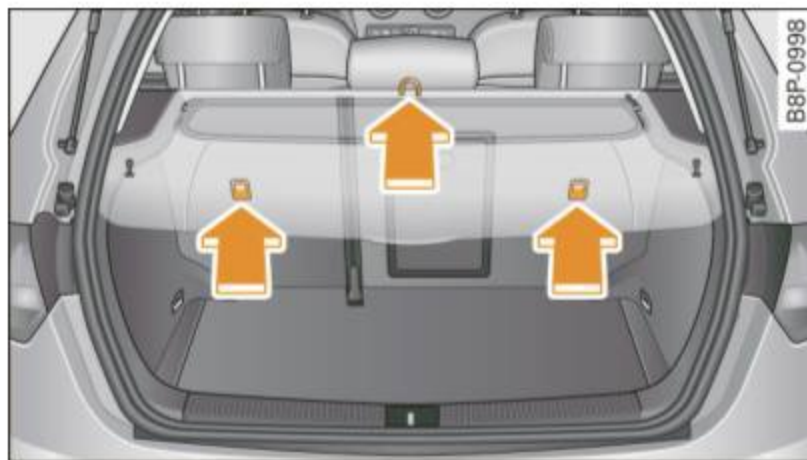

Fig. 152 Tether anchors: attachment hook locations behind the rear seatbacks

The tether anchors for the rear seating positions are located on the backside of the rear seatbacks ⇒ fig. 152.

A tether is a straight or V-shaped strap that attaches the top part of a child restraint to special anchorage points in the vehicle.

The purpose of the tether is to reduce the forward movement of the child restraint in a crash, in order to help reduce the risk of head injury that could be caused by striking the vehicle interior.

Forward facing child restraints manufactured after September 1, 1999, are required by U.S. federal regulations to comply with new child head movement performance requirements. These new performance requirements make a tether necessary on most new child safety seats.

WARNING

Improper installation of child restraints will increase the risk of injury and death in a crash.

- Always follow the instructions provided by the manufacturer of the child restraint you intend to install in your Audi.
- Improper use of child restraint anchors (including tether anchors) can lead to injury in a collision. The anchors are designed

WARNING (continued)

to withstand only those loads imposed by correctly fitted child restraints.

- Never mount two child restraint systems on one LATCH lower anchor point.
- Never attach two child restraint systems to one tether strap or tether anchorage.
- Never attach a tether strap to a tie-down hook in the luggage compartment.
- Never use child restraint tether anchorages to secure safety belts or other kinds of occupant restraints.
- Never secure or attach any luggage or other items to the LATCH lower anchorages or to the tether anchors.
- If a tether or other strap is used to attach a child restraint to the front passenger seat, make sure that it is not so tight, that it causes the weight-sensing mat to measure more weight than is actually on the seat.
- The heavier weight registered can make the Advanced Airbag System work as though an adult were on the seat and deploy the Advanced Airbag when it must be suppressed causing serious or even fatal injury to the child.
- If you must install a rearward facing child safety seat on the front passenger seat because of exceptional circumstances and the PASSENGER AIR BAG OFF light does not come on and stay on, immediately install the rear-facing child safety seat in a rear seating position and have the airbag system inspected by your Audi dealer. ■

Installing the upper tether strap on the anchorage

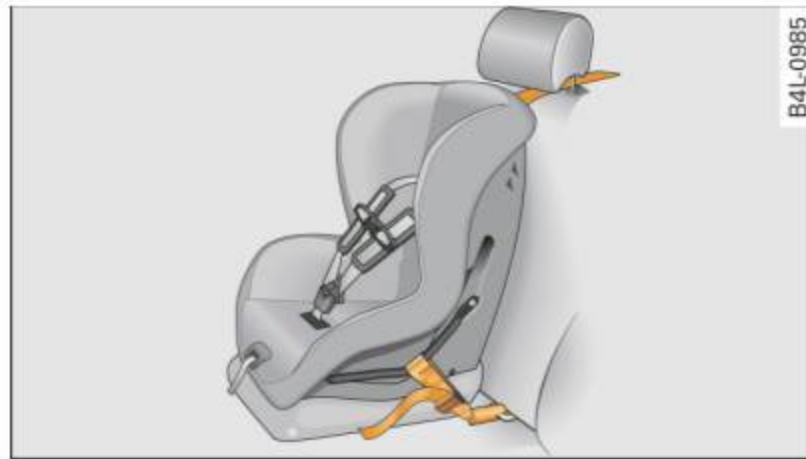

Fig. 153 Tether strap: proper routing and mounting

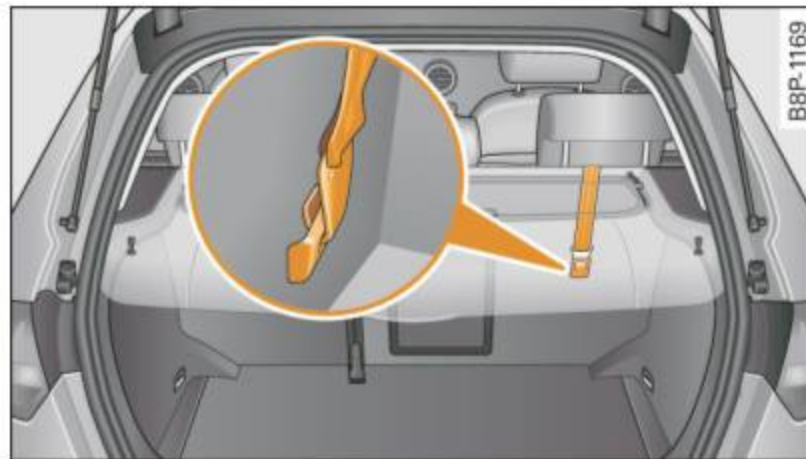

Fig. 154 Tether strap: proper routing and mounting

Installing the tether strap

- Release or deploy the tether strap on the child restraint according to the child restraint manufacturer's instructions.
- Guide the upper tether strap **under** the rear head restraint and into the rear cargo area ⇒ fig. 154 (raise the head restraint if necessary).
- Slide the tether strap hook over the anchor bracket.

- Pull on the tether strap hook so that the spring catch of the hook engages.
- Tighten the tether strap firmly following the child restraint manufacturer's instructions.

Releasing the tether strap

- Loosen the tension following the child restraint manufacturer's instructions.
- Depress the spring catch on the hook and release it from the anchorage.

! Note

If you leave the child restraint with the tether strap firmly installed for several days, this could leave a mark on the upholstery on the seat cushion and backrest in the area where the tether strap was installed. The upholstery would also be permanently stretched around the tether strap. This applies especially to leather seats. ■

Using tether straps on rearward-facing child restraints

Currently, few rear-facing child restraint systems come with a tether. Please read and heed the child restraint system manufacturer's instructions carefully to determine how to properly install the tether.

! WARNING

A child in a rearward-facing child safety seat installed on the front passenger seat will be seriously injured and can be killed if the front airbag inflates - even with an Advanced Airbag System.

- The inflating airbag will hit the child safety seat or infant carrier with great force and will smash the child safety seat and child against the backrest, center armrest, or door.

⚠ WARNING (continued)

- A tight tether or other strap on a rearward-facing child restraint attached to the front passenger seat can put too much pressure on the weight-mat in the seat and register a heavier weight in the Advanced Airbag System. The heavier weight registered can make the system work as though an adult were on the seat and deploy the Advanced Airbag when it must be suppressed causing serious or even fatal injury to the child.
- If you must install a rearward facing child safety seat on the front passenger seat because of exceptional circumstances and the PASSENGER AIR BAG OFF light does not come on and stay on, immediately install the rear-facing child safety seat in a rear seating position and have the airbag system inspected by your Audi dealer. ■

Safety BeltSafe U.S.A

Tel.: (800) 745-SAFE (English)

Tel.: (800) 747-SANO (Spanish)

www.carseat.org**Transport Canada Information Centre**

Tel.: 1 (800) 333-0371 or call 1 (613) 998-8616 if you are in the Ottawa area

www.tc.gc.ca/roadsafety**Audi Customer CARE**

Tel.: (800) 822-2834 ■

Additional Information

Sources of information about child restraints and their use

There are a number of sources of additional information about child restraint selection, installation and use:

NHTSA advises that the best child safety seat is the one that fits your child and fits in your vehicle, and that you will use correctly and consistently.

Try before you buy!

U.S National Highway Traffic Safety Administration

Tel.: 1-888-327-4236 (TTY: 1-800-424-9153)

www.nhtsa.gov**National SAFE KIDS Campaign**

Tel.: (202) 662-0600

www.safekids.org

Intelligent technology

Notice about data recorded by vehicle control modules

Your vehicle is not equipped with an Event Data Recorder (EDR), installed by some manufacturers for the express purpose of capturing data for retrieval after an accident or crash event. EDR's are sometimes called "crash recorders".

Some state laws restrict the retrieval or downloading of data stored by EDR's that were installed in a vehicle for the express purpose of retrieving data after an accident or crash event without the owner's consent.

Although your vehicle is not equipped with an EDR, it is equipped with a number of electronic control modules for various vehicle systems such as, for example, engine function, emission control, as well as for the airbags and safety belts.

These electronic control modules also record vehicle-related data during normal vehicle operation for diagnostic and repair purposes. The recording capacity of the electronic control modules is limited to data (no sound is recorded) and only a small amount of data is actually recorded over a very limited period of time and stored when a system fault or other condition is sensed by a control unit. Some of the data then stored may relate to vehicle speed, direction, braking as well as restraint system use and performance in the event of a crash or other condition. Stored data can only be read and downloaded with special equipment. ■

Electronic Stabilization Program (ESP)

General

The Electronic Stability Program increases driving stability.

With ESP, control over the vehicle is increased in situations when the vehicle is close to the limits of grip, such as during acceleration and in curves. ESP reduces the risk of skidding and improves vehicle stability under all road conditions. It operates at all speeds.

The Anti-Lock Brake System (ABS), Electronic Differential Lock (EDS) and Anti-Slip Regulation System (ASR) are integrated in the Electronic Stability Program.

How ESP works

The ESP control unit processes the following data from high-sensitive sensors: the rotational speed of the vehicle about its vertical axis, fore-and-aft and lateral acceleration forces, brake pressure and steering angle.

Using steering angle and vehicle speed, the direction the driver wishes to travel is determined and continuously compared with actual vehicle behavior. If the two do not match, for example when the vehicle begins to skid, ESP brakes the appropriate wheel automatically.

The vehicle is stabilized again by the forces acting on the wheel during braking. With an *oversteering* vehicle (tendency for the rear end to skid out of the curve), the brake application is mainly at the front wheel on the outside of the curve, with an *understeering* vehicle (tendency to run wide in the curve) at the rear wheel on the inside of the curve or additionally at the other wheels as needed. This brake application is accompanied by noises. ►

ESP works in conjunction with ABS ⇒ *page 192*. If there is malfunction in the ABS, ESP is also inoperative.

WARNING

- The limits of physics cannot be suspended by ESP. Even in vehicles with ESP, you should always adapt your driving to road and traffic conditions. This is particularly true on a slippery and wet road. Do not be tempted by the increased safety provided to take risks – danger of an accident!
- Please note that when ESP/ASR is deactivated, the drive wheels can spin on icy and slippery roads and the vehicle can break away - danger of skidding! ■

Switching on and off



Fig. 155 Center console with ESP switch

The ESP is automatically activated when the engine is started, and it performs a self-test. As soon as the test is completed, the system is in normal operating mode.

Deactivating

ESP should normally be activated at all times because this ensures optimum vehicle stability. Only in some cases it does make sense to deactivate the Electronic Stability Program (ESP) by pressing the button ⇒ *fig. 155*. Deactivation is indicated by the ESP lamp  in the

instrument cluster flashes. The message **ESP OFF** appears in the instrument cluster. Anti-Slip Regulation is completely deactivated and the stabilization effects from the ESP system are limited. This makes a more agile and sporty driving style possible, but the full extent of the stabilization function is not available.

Activating

Press the **ESP OFF** button again ⇒ *fig. 155*. The indicator light  goes out. The message **ESP ON** appears briefly in the instrument cluster display.

WARNING

You should only switch the ESP off if your driving ability and the traffic situation allow. Please note that when ESP/ASR is deactivated, the drive wheels can spin on icy and slippery roads and the vehicle can break away - danger of skidding!

Tips

If Audi magnetic ride* is malfunctioning, the ESP may not switch off or it may switch off automatically. ■

Electronic differential lock (EDL)

The electronic differential lock monitors the rotational speed of the drive wheels.

General notes

The electronic differential lock (EDL) helps the car to start moving, accelerate and climb a gradient on surfaces providing poor or almost no grip. Without EDL, this would be difficult, if not impossible.

How the system works

The EDL operates automatically. It monitors the rotational speed of the drive wheels on an axle with the help of the ABS sensors ⇒ *page 192*. If a noticeable *difference in rotational speed* between 

the drive wheels on one axle is detected (e.g. on slippery ground *on one side*), the spinning wheel is braked, thereby transferring power to the other drive wheel or wheels (all-wheel drive). This is done up to a speed of about 60 mph (100 km/h). Noises from the brake system signal that wheel spin is being controlled.

Driving off

When driving off, always be sure to keep road conditions in mind as you accelerate. If one drive wheel spins because it is on a surface with less grip, gradually increase the pressure on the accelerator pedal until the car starts to move. The wheel less able to transfer power spins.

Overheating of brakes

To prevent the disc brake of the braked wheel from overheating if subjected to excessive loads, the EDL cuts out temporarily. The vehicle remains operational and behaves in the same way as a vehicle without EDL.

As soon as the brake has cooled down, EDL switches on again automatically.

Electronic limited slip differential*

In vehicles with front wheel drive*, an electronic limited slip differential engages when driving on curves. The brakes are applied specifically to the front wheel that is on the inside of the curve. This minimizes sliding on the front wheels and enables precise and neutral driving through curves. The electronic limited slip differential does not engage when driving in wet conditions or snow.

WARNING

- When accelerating on slippery surfaces, such as on ice or snow, always be careful when depressing the accelerator pedal. Even with the EDL and the electronic limited slip differential working, the drive wheels can spin and reduce your ability to control your car. - Risk of crash!

WARNING (continued)

- The increased safety afforded by EDL and the electronic limited slip differential does not mean that you can take safety risks. Always adapt your driving style to the road conditions and traffic situation.

Tips

If a fault occurs in the ABS, the EDL is also not functioning. This is indicated by the ABS warning light ⇒ *page 16*. ■

Anti-Slip Regulation System (ASR)

The Anti-Slip Regulation System prevents the driven wheels from spinning when the car is accelerating.

General notes

The Anti-Slip Regulation System (ASR) is integrated in the electronic stabilization program (ESP). When the vehicle starts up and accelerates, the wheels are prevented from spinning by adjusting the engine power to match the amount of grip available from the road surface.

How the system works

ASR performs automatically, i.e. without the driver's intervention. With the aid of the ABS sensors ⇒ *page 192*, ASR monitors the speed of the driven wheels. If the wheels start to spin, the engine torque is reduced automatically until the tires find enough grip to lock onto the road surface. The system is active across the entire speed range.

The ASR works in conjunction with the ABS. If a malfunction should occur in the ABS, the ASR will also be out of action.

Tips

To ensure that the ASR works properly, all four wheels must be fitted with identical tires. Any differences in rolling radius of the tires can ►

cause the system to reduce engine power when this is not desired. See also ⇒ *page 257*, “New tires and replacing tires and wheels”. ■

Braking

General information

What affects braking efficiency?

Operating conditions and driving habits

The brakes on today’s automobiles are still subject to wear, depending largely on operating conditions and driving habits ⇒ ⚠. On vehicles that are either driven mostly in stop-and-go city traffic or are driven hard, the brake pads should be checked by your authorized Audi dealer more often than specified in the **Warranty & Maintenance booklet**. Failure to have your brake pads inspected can result in reduced brake performance.

On steep slopes, you should use the braking effect of the engine. This way, you prevent unnecessary wear on the brake system. If you must use your brakes, do not hold the brakes down continuously. Pump the brakes at intervals.

Noises may occur when braking depending on speed, braking force and outside conditions such as temperature and humidity.

Moisture or road salt

If you are driving faster than 50 mph (80 km/h) and the windshield wipers are on, the brake pads will briefly touch the brake discs in regular intervals so as to improve reaction time when braking on wet surfaces. You, the driver, will not notice anything.

Under certain conditions, for example, when driving through water or very heavy rain, or even after washing your vehicle, the braking effect can be reduced due to moisture (or in freezing conditions ice) on the brake pads. A few cautious brake applications should dry off the brake pads or remove any ice coatings.

The effectiveness of the brakes can be reduced when the vehicle is driven on a salt-covered road and the brakes are not used. Likewise, you clean off accumulated salt coating from brake discs and pads with a few cautious applications of the brake ⇒ ⚠.

Corrosion

There may be a tendency for dirt to build up on the brake pads and corrosion to form on the discs if the car is not driven regularly or only for short trips with little use of the brakes.

If the brakes are not used frequently, or if corrosion has formed on the discs, it is advisable to clean off the pads and discs by braking firmly a few times from a moderately high speed ⇒ ⚠.

Faults in the brake system

If you should notice a *sudden* increase in brake pedal travel, then one of the two brake circuits may have failed ⇒ ⚠.

Low brake fluid level

Malfunctions can occur in the brake system if the brake fluid level is too low. The brake fluid level is monitored electronically.

Brake lining wear status

Brake lining wear may be checked by visual inspection of the condition of the brake pads through the openings in the wheel. If necessary, the wheel may be removed for this inspection ⇒ *page 272*, “Wheel change”.

WARNING

- You should perform braking maneuvers for the purpose of cleaning the brake system only if road conditions permit. Other road users must not be put at risk - you may cause an accident!
- Before descending a steep grade, reduce speed and shift transmission into a lower gear or lower driving range. Do not ride the brakes or hold the pedal down too long or too often. This could cause the brakes to get hot and diminish braking efficiency.

⚠ WARNING (continued)

- Do not “ride the brakes” by resting your foot on the pedal when you do not intend to brake. This may cause the brakes to overheat, premature wear and increased stopping distance.
- Under certain climatic and operating conditions such as passing through water, driving in heavy rain or after washing the vehicle, the effectiveness of the brakes can be reduced. In winter, ice can accumulate on the brake pads, linings, discs and drums. Carefully apply brakes for a test. Brakes will dry and ice coatings will be cleaned off after a few careful brake applications.
- Driving for an extended period of time on salt-covered roads without using your brakes can also affect braking efficiency. Clean off accumulated salt coating from brake discs and pads with a few careful brake applications.
- If you damage the front spoiler, or if you install a different spoiler, be sure the air flow to the front brakes is not obstructed. Otherwise the brake system could overheat reducing the effectiveness of the entire brake system.
- Failure of one brake circuit will impair the braking capability resulting in an increased stopping distance. Avoid driving the vehicle and have it towed to the nearest authorized Audi dealer or qualified workshop. ■

Brake booster

The brake booster adds extra braking power.

The brake booster works with vacuum pressure which is created only when the engine is running ⇒ ⚠.

⚠ WARNING

- Never let the vehicle roll to a stop with the engine shut off.
- If the brake booster is not working, for example when towing your vehicle, or because the brake booster has somehow been

⚠ WARNING (continued)

damaged, the brake pedal must be pressed considerably harder to make up for the lack of booster assistance. ■

Functioning of Anti-Lock Brake System (ABS)

ABS prevents the wheels from locking up under braking.

The ABS contributes effectively to vehicle control since it prevents the wheels from *locking* when the brakes are applied. This means that the vehicle remains steerable and is less likely to skid.

With ABS you do not need to pump the brake. Just hold the brake pedal down.

However, do not expect that the ABS shortens braking distance under *all* circumstances. When driving on gravel or on newly fallen snow on top of icy surfaces, braking distance may be even longer, therefore, under these circumstances, it is especially important that you drive slowly and with great care.

How the ABS system works

An automatic check is made when a speed of about 4 mph (6 km/h) is reached. When this happens, a pumping noise can be heard.

If an individual wheel begins to rotate too slowly in relation to vehicle speed and tends to lock, the ABS automatically reduces brake pressure to prevent that wheel from locking.

This automatic adjustment process will cause a **slight vibration** of the brake pedal and some noises to alert you that vehicle speed must be adapted to existing road and traffic conditions.

⚠ WARNING

Although the ABS is very effective, always remember that braking capability is limited by tire traction. Always adjust your driving

⚠ WARNING (continued)

speed according to the road and traffic conditions. Do not let the extra safety afforded by the ABS tempt you into taking extra risks. The ABS cannot overcome the laws of physics.

i Tips

- If ABS is not functioning properly, a warning light will come on. See ⇒ page 16.
- If a fault occurs in the ABS, the EDL is also not functioning. This is indicated by the ABS warning light. ■

Brake assistant

The brake assistant is designed to achieve the optimum braking effect.

The brake assistant helps to increase the *effective* braking power and thus to achieve a shorter stopping distance. If the driver presses the brake pedal very quickly, the brake assistant automatically boosts the braking force to the maximum level, up to the point where the anti-lock brake function (ABS) intervenes to stop the wheels from locking. You should then keep the brake pedal pressed until the vehicle has braked to the required speed. The brake assistant switches itself off as soon as you release the brake pedal.

The brake assistant will not be operative if there is a malfunction in the ABS.

⚠ WARNING

Please remember that the accident risk always increases if you drive too fast, especially in corners or on a slippery road, or if you follow the vehicle ahead of you too closely. An increased accident risk cannot be compensated even by the brake assistant, so always maintain a safe speed. ■

Electro-mechanical power assist

The electro-mechanical power assist helps the driver when steering.

The degree of power assist is *electronically* matched to vehicle speed.

The power steering system assists the driver so that he can steer the vehicle with reduced physical effort.



Power steering will not work if the engine is off. As a result, the steering wheel will be hard to turn.

⚠ WARNING

If the system develops a problem, you must seek qualified professional assistance.

! Note

If there is an electronic malfunction, *servotronic* will still function like a conventional power steering system, providing a constant steering support force that is no longer proportionate to the vehicle speed. This is most noticeable when turning the steering wheel at low speeds (for example when parking), - more effort will be required than usual.

- Be aware of the different than usual steering response and adjust your steering force accordingly.
- Have the problem checked and set right by an authorized Audi dealer as soon as possible.
- If a steering malfunction occurs, this is signaled with the  or  indicator lights and a warning tone, see .

i Tips

- If the power steering system should fail, or if the engine is not running (for example, while being towed), you will still be able to steer the vehicle. However, more effort will be required to do so. ▶

- If the power steering system is not functioning properly, contact your authorized Audi dealer immediately. ■

Applies to vehicles: with All Wheel Drive

Driving with your quattro®

With All Wheel Drive, all four wheels are driven.

General information

With All Wheel Drive, power is distributed to all four wheels. This happens automatically depending on your driving style and the road conditions at the time. See also ⇒ *page 189*, “Electronic differential lock (EDL)”.

Winter tires

When driving in the winter, your vehicle with All Wheel Drive has an advantage, even with regular tires. In winter road conditions it may be advisable to mount winter tires (or all-season tires) for improved driveability and braking: these tires must be mounted on **all four wheels**. See also ⇒ *page 261*, “Winter tires”.

Snow chains

Where snow chains are mandatory on certain roads, this normally also applies to vehicles with all-wheel drive ⇒ *page 262*, “Snow chains”.

Replacing wheels/tires

Vehicles with All Wheel Drive must always have tires of the same size. Also avoid tires with different tread depths. For details see page ⇒ *page 257*, “New tires and replacing tires and wheels”.

Off-Road driving?

Your Audi does not have enough ground clearance to be used as an off-road vehicle. It is therefore best to avoid rough tracks and uneven terrain as much as possible. Also refer to ⇒ *page 199*.

WARNING

Always adjust your driving to road and traffic conditions. Do not let the extra safety afforded by the all-wheel drive tempt you into taking extra risks.

- Although the quattro® all-wheel drive is very effective, always remember that braking capacity is limited by tire traction. You should therefore not drive at excessive speeds on icy or slippery road surfaces.
- On wet road surfaces, be careful not to drive too fast because the front wheels could begin to slide on top of the water (hydroplaning). If this should occur, you will have no warning from a sudden increase in engine speed as with a front-wheel drive vehicle. Always drive at speeds which are adjusted to the road conditions – risk of crash! ■

Energy management

Starting ability is optimized

Energy management controls the distribution of electrical energy and thus optimizes the availability of electrical energy for starting the engine.

If a vehicle with a conventional energy system is not driven for a long period of time, the battery is discharged by idling current consumers (e.g. immobilizer). In certain circumstances it can result in there being insufficient energy available to start the engine.

Intelligent energy management in your vehicle handles the distribution of electrical energy. Starting ability is markedly improved and the life of the battery is extended.

Basically, energy management consists of **battery diagnosis**, **idling current management** and **dynamic energy management**. ►

Battery diagnosis

Battery diagnosis continuously determines the state of the battery. Sensors determine battery voltage, battery current and battery temperature. This determines the current state of charge and the power of the battery.

Idling current management

Idling current management reduces energy consumption while the vehicle is standing. With the ignition switched off, it controls the energy supply to the various electrical components. Data from battery diagnosis is considered.

Depending on the battery's state of charge, individual consumers are gradually turned off to prevent excessive discharge of the battery and thus maintain starting capability.

Dynamic energy management

While the vehicle is being driven, dynamic energy management distributes the energy generated according to the needs of the individual components. It regulates consumption, so that more electrical energy is not being used than is being generated and ensures an optimal state of charge for the battery.



Tips

- But even energy management cannot negate the limits of physics. Consider that the power and life of a battery are limited.
- If starting ability is threatened, you are informed by a warning ⇒ page 196, "Driver notification in the instrument cluster display". ■

What you should know

The highest priority is given to maintaining starting capability.

The battery is severely taxed in short-distance driving, in city traffic and during the cold time of year. Abundant electrical energy is

required, but only a little is generated. It is also critical if the engine is not running and electrical components are turned on. In this instance energy is being consumed but none is being generated.

It is in precisely these situations that you will notice energy management actively regulating the distribution of energy.

Vehicle stands for an extended period

If you do not drive your vehicle over a period of several days or weeks, electrical components are gradually cut back or switched off. This reduces energy consumption and maintains starting capability over a longer period.

Take into consideration that when you unlock your vehicle, some convenience functions, such as the remote key or power seat adjustment, may not be available. The convenience functions will be available again when you turn on the ignition and start the engine.

With the engine turned off

If you listen to the radio, for example, with the engine turned off, the battery is being discharged.

If starting capability is jeopardized due to energy consumption, a message appears in the driver information display.

You have to start the engine to charge the battery.

With the engine running

Although electrical energy is generated when the vehicle is being driven, the battery can become discharged. This happens mostly when little energy is being generated and a great deal consumed and the battery's state of charge is not optimal.

To bring the energy balance back into equilibrium, consumers which require especially large amounts of energy are temporarily cut back or switched off. Heating systems in particular require a great deal of energy. If you notice, for example, that the heated seats* or the heated rear window are not heating, they have been temporarily cut back or switched off. These systems will be available again as soon as the energy balance has been restored. ►

You will also notice that engine idle speed has been increased slightly. This is normal and not a cause for concern. By increasing engine idle speed the additional energy required is generated and the battery is charged. ■

Driver notification in the instrument cluster display

If battery power drops into the range where it can limit the ability of the engine to start, this is shown in the instrument cluster display with the following driver message:

Low battery charge: battery will be charged while driving

This notification reminds you that the starting capability of the engine may be limited. As soon as you start driving again, the battery will be recharged and the notification will go out.

Driver notification appears and goes out again

If this driver notification appears after the ignition is turned on or while driving and it goes out again after a while, the battery has been adequately recharged.

Driver notification appears and does not go out again

If this driver notification appears after the ignition is turned on or while driving and does not go out again, the battery's state of charge is not in the optimal range. Starting ability is restricted. Have the battery checked as soon as possible by an authorized Audi dealer or qualified workshop. ■

Driving and environment

The first 1,000 miles (1,500 km) and afterwards

New engine

The engine needs to be run-in during the first 1,000 miles (1,500 km).

For the first 600 miles (1,000 kilometers):

- Do not use full throttle.
- Do not drive at engine speeds that are more than 2/3 of the maximum permitted RPM.

From 600 to 1,000 miles (1,000 to 1,500 kilometers):

- Speeds can *gradually* be increased to the maximum permissible road or engine speed.

During and after break-in period

- Do not rev the engine up to high speeds when it is cold. This applies whether the transmission is in N (Neutral) or in gear.

After the break-in period

- Do not exceed maximum engine speed under any circumstances.
- Upshift into the next higher gear *before* reaching the red area at the end of the tachometer scale ⇒ *page 8*.

During the first few hours of driving, the engine's internal friction is higher than later when all the moving parts have been broken in. How

well this break-in process is done depends to a considerable extent on the way the vehicle is driven during the first 1,000 miles (1,500 kilometers).



Note

Extremely high engine speeds are automatically reduced. However, these RPM-limits were programmed for an engine well run-in, not a new engine.



For the sake of the environment

Do not drive with unnecessarily high engine speeds - upshifting early saves fuel, reduces noise and protects the environment. ■

New tires

If your vehicle is running on new tires, drive particularly careful for the first 300 miles (500 kilometers) after fitting.



WARNING

New tires tend to be slippery and must also be "broken-in". Be sure to remember this during the first 300 miles (500 kilometers). Brake gently. Avoid following closely behind other vehicles or other situations that might require sudden, hard braking. ■

New brake pads

Remember that new brake pads do not have a full braking effect during the first 250 miles (400 kilometers) after they are installed. ►

New brake pads have to be “burnished in” before they have optimal grab ⇒ .

During the break-in period, you should avoid putting severe loads on the brakes. Severe loads include, for example, sudden hard braking, in particular at very high speeds or, for example, on mountain passes.

WARNING

Until they develop the maximum “bite” for best stopping power, the surfaces on new brake pads require some “breaking-in” during the initial 100 to 150 miles (150 to 200 kilometers) of normal city driving. You can compensate for this by pressing the brake pedal more firmly. This applies whenever new pads are installed. ■

Driving through water on roads

Note the following to avoid vehicle damage when driving through water, for example on flooded roads:

- The water must not be any higher than the bottom of the vehicle body.
- Do not drive faster than walking speed.

WARNING

After driving through water, mud, slush, etc., the brakes may be slow to take effect because of wet brake rotors and pads. Dry the brakes first by braking carefully to restore the full braking effect.

Note

Vehicle components such as the engine, transmission, suspension or electrical system can be severely damaged by driving through water.

Tips

- Check the depth of the water before driving through it.
- Do not stop the vehicle, drive in reverse or switch the engine off when driving through water.
- Keep in mind that oncoming vehicles may create waves that raise the water level and make it too deep for your vehicle to drive through safely.
- Avoid driving through salt water because it can cause corrosion. ■

Catalytic converter

It is very important that your emission control system (catalytic converter) is functioning properly to ensure that your vehicle is running in an environmentally sound manner.

- Always use lead-free gasoline ⇒ *page 219*, “Fuel supply”.
- Never run the tank down all the way to empty.
- Never put too much motor oil in your engine ⇒ *page 232*, “Adding engine oil 

The catalytic converter is an efficient “clean-up” device built into the exhaust system of the vehicle. The catalytic converter burns many of the pollutants in the exhaust gas before they are released into the atmosphere.

The exclusive use of unleaded fuel is critically important for the life of the catalytic converter and proper functioning of the engine. ►

WARNING

- Do not park or operate the vehicle in areas where the hot exhaust system may come in contact with dry grass, brush, fuel spill or other material which can cause a fire.
- Do not apply additional undercoating or rustproofing on or near the exhaust manifold, exhaust pipes, catalytic converter or heat shields. During driving, the substance used for undercoating could overheat and cause a fire.

Note

- Be aware that just one tank filling with **leaded** fuel will already seriously degrade the performance of the catalytic converter.
- Do not exceed the correct engine oil level ⇒ *page 232*.
- Do not drive until the fuel tank becomes completely empty. The engine could misfire. Unburned fuel could also get into the exhaust system and this could cause the catalytic converter to overheat.
- Do not turn off the ignition while the vehicle is moving.
- Do not continue to operate your vehicle under these conditions, as otherwise fuel can reach the catalytic converter. This could result in overheating of the converter, requiring its replacement.
- To assure efficient operation of the Emission Control System:
 - Have your vehicle maintained properly and in accordance with the service recommendations in your Warranty & Maintenance booklet.
 - Lack of proper maintenance as well as improper use of the vehicle will impair the function of the emission control system and could lead to damage.

For the sake of the environment

Even when the Emission Control System is operating properly, the exhaust gas can have a sulfur-like exhaust gas smell under some operating states. This depends on the sulfur content of the fuel being

used. Using a different brand of fuel may help, or filling the tank with lead-free super grade gasoline. ■

Applies to vehicles: with diesel particulate filter

Diesel particulate filter

The diesel particulate filter filters nearly all of the soot particles out of the exhaust. The filter cleans itself automatically under normal driving conditions. If the filter cannot clean itself (for example, because you are only driving short distances), the filter becomes clogged with soot and the  symbol for the diesel particulate filter illuminates ⇒ *page 34*.

WARNING

- Do not park your vehicle over flammable materials such as grass or leaves because the high temperature of the diesel particulate filter could start a fire.
- Do not apply an underbody protectant in the exhaust system area or a fire could start.

Tips

- When the diesel particulate filter becomes saturated, the engine speed increases to approximately 1,500 rpm while the vehicle is in motion to initiate the cleaning of the diesel particulate filter automatically without the warning lamp lighting up. If the warning lamp  still appears, you should drive to a qualified workshop. ■

Avoid damaging the vehicle

When you are driving on poor roads, or over curbs, steep ramps, etc., make certain that low-lying parts such as spoilers and exhaust system parts do not bottom out and get damaged. ►

This is especially true for vehicles with low-slung chassis (sports chassis) and fully loaded vehicles. ■

Operate your vehicle economically and minimize pollution

General

Your personal style of driving will determine the economy of your vehicle, as well as exhaust and noise levels.

Fuel economy, environmental impact, and wear on your engine, brakes and tires largely depend on three factors:

- your personal driving style
- operating conditions
- technical limitations

If you anticipate what you need to do next and drive economically, you can easily cut your fuel consumption by 10-15 percent. This section will give you some tips on how you can help the environment and your pocketbook.



Tips

The consumption estimates as published by ENVIRONMENTAL PROTECTION AGENCY (EPA) and Transport Canada may not correspond to your actual consumption on the road, which will vary depending upon vehicle load and speed, road and weather conditions, trip length, etc. ■

Drive smoothly and keep a lookout ahead

Vehicles use the most fuel when they are accelerating.

Avoid unnecessary accelerating and braking.

Vehicles use the most fuel when they are accelerating. If you anticipate what is going to happen next, you will need to brake less and, thus, accelerate less. Let the vehicle coast whenever possible - for example when you see that the next traffic light is red. ■

Avoid full throttle

Driving at moderate speeds saves fuel and improves your mileage.

- Try and keep well below your car's maximum speed.

Accelerating gently reduces fuel consumption, engine wear, and does not disturb the environment.

Fuel consumption, exhaust emissions and engine noise increase disproportionately at high speeds. If you drive at approximately three quarters of top speed, fuel consumption will be reduced by one half. Never drive faster than the posted speed limit and weather conditions permit. ■

Reducing unnecessary idling

Even when your car is just idling it burns up fuel.

- Shut the engine off when you are not driving the vehicle.
- Do not warm up the vehicle by letting the engine run at idle.

It makes sense to shut off the engine in traffic jams, when waiting for trains to pass at railroad crossings, or at traffic lights that have long waits on red. Turning the engine off for just 30-40 seconds saves more fuel than is burned starting the engine again.

It takes a long time for the engine to warm up fully when it is running at idle. However, wear and noxious emissions are especially high when the engine is warming up. So you should drive away as soon as ►

you start the engine and avoid running at high RPMs while the engine is still warming up.

Note

Do not leave engine idling unattended after starting. If warning lights should come on to indicate improper operation, they would go unheeded. Extended idling also produces heat, which could result in overheating or other damage to the vehicle or other property. ■

Regular maintenance

A badly tuned engine unnecessarily wastes a lot of fuel.

- Have your vehicle serviced at regular intervals.

By having your vehicle regularly serviced by an authorized Audi dealer helps to ensure that it runs properly and economically. The condition of your vehicle not only affects its safety and ability to hold its value, it also affects **fuel consumption**.

Check your oil each time you fill your tank.

The amount of oil used is related to engine load and speed.

It is normal for the oil consumption of a new engine to reach its lowest value after a certain mileage has been driven.

You must drive your vehicle about 3,000 miles (5,000 kilometers) before you can properly assess oil consumption.

This also applies to fuel consumption and engine output.

Note

- Have your vehicle maintained properly and in accordance with the service recommendations in your Warranty & Maintenance booklet. Lack of proper maintenance as well as improper use of the vehicle will impair the function of the emission control system and could lead to damage.

- Do not alter or remove any component of the Emission Control System unless approved by the manufacturer.
- Do not alter or remove any device, such as heat shields, switches, ignition wires, valves, which are designed to protect your vehicle's Emission Control System and other important vehicle components. ■

Fewer short trips

Fuel consumption will always be relatively high on short trips.

- Try to avoid driving short distances with a cold engine.

The engine and catalytic converter have to reach their optimal **operating temperature** to reduce fuel consumption and noxious emissions effectively.

- Just after starting, a cold engine in a mid-size car burns the fuel at a poor rate of 6-8 miles per gallon (30-40 l/100km). Half a mile down the road, the mileage improves to 12 MPG (20 l/100 km). It will take the engine no less than *two and a half miles (4 km)* of driving to warm up to its proper operating temperature and operate at an economic mileage. This explains why taking the car for short trips is a rather wasteful convenience.
- The **outside temperature** is also critical in this regard. Your car consumes more fuel in the winter than in the summer. ■

Trailer towing

Driving with a trailer

General information

Your Audi was designed primarily for passenger transportation.

If you plan to tow a trailer, please remember that the additional load will affect durability, economy and performance.

Trailer towing not only places more stress on the vehicle, it also calls for more concentration from the driver.

For this reasons, always follow the operating and driving instructions provided and use common sense. ■

Technical requirements

Trailer hitch

Use a weight-carrying hitch conforming to the gross trailer weight. The hitch must be suitable for your vehicle and trailer and must be mounted securely on the vehicle's chassis at a *technically sound* location. Use only a trailer hitch with removable ball mount. Always check with the trailer hitch manufacturer to make sure that you are using the correct hitch.

Do not use a bumper hitch.

The hitch must be installed in such a way that it does not interfere with the impact-absorbing bumper system. No modifications should be made to the vehicle exhaust and brake systems. From time to time, check that all hitch mounting bolts remain securely fastened.

When you are not towing a trailer, remove the trailer hitch ball mount. This prevents the hitch from causing damage should your vehicle be struck from behind ⇒ .

Tire pressure

When towing a trailer, inflate the tires of your vehicle to the cold tire pressure listed under "Full load" on the sticker on the right doorjamb. Inflate trailer tires to trailer and tire manufacturers' specifications.

Lights

The headlight settings should be checked with the trailer attached before driving off. Have the headlights adjusted as necessary so that you can see the road ahead but not blind oncoming traffic.

Check to make sure both vehicle and trailer lights are working properly.

Engine cooling system

Towing a trailer makes the engine work harder. It is important that the cooling system's performance stands up to the additional strain. Make sure that the cooling system has enough fluid.

Trailer brakes

If your trailer is equipped with a braking system, check to be sure that it conforms to all regulations.

The trailer hydraulic brake system must not be directly connected to the vehicle's hydraulic brake system.

Safety chains

Be sure trailer safety chains are properly connected from the trailer to the hitch on the vehicle. Leave enough slack in the chains to permit turning corners. When you install safety chains, make sure they will not drag on the road when you are driving.

The chains should cross under the trailer tongue to prevent it from dropping in case of separation from the hitch.

Trailer lights

Trailer lights must meet all regulations. Be sure to check with your authorized Audi dealer for correct wiring, switches and relays. ►

Mirrors

If you are unable to see the traffic behind you using the regular outside mirrors, then you *must* install extended mirrors. It is important that you *always* have clear vision to the rear.

WARNING

After removing the trailer hitch, do not store it in your vehicle. In case of sudden braking, the hitch could fly forward and injure you or your passengers. ■

Operating instructions

Maximum trailer weight

A trailer for your vehicle is limited to a typical class 1 or class 2 trailer.

Trailer load distribution

Be sure the load in the trailer is held securely in place to guard against shifting, be it forward, backward or sideways.

Never allow a passenger to ride in a trailer ⇒  in “Driving instructions”.

Tire pressure

When towing a trailer, inflate the tires of your vehicle to the cold tire pressure listed under “Full load” on the sticker on the right doorjamb. Inflate trailer tires to trailer and tire manufacturers’ specifications.

Lights

The headlight settings should be checked with the trailer attached before driving off. Adjust as necessary so that you can see the road ahead but not blind oncoming traffic.

Check proper working of vehicle and trailer lights.

Safety chains

Be sure trailer safety chains are properly connected from the trailer to the hitch on the vehicle. Leave enough slack in the chains to permit turning corners. When you install safety chains, make sure they will not drag on the road when you are driving.

The chains should cross under the trailer tongue to prevent it from dropping in case of separation from the hitch. ■

Driving instructions

Driving with a trailer always requires extra care and consideration.

To obtain the best possible handling of vehicle and trailer, please note the following:

- Do not tow a loaded trailer when your car itself is not loaded.
- Be especially careful when passing other vehicles.
- Observe speed limits.
- Do not drive at the maximum permissible speed.
- Always apply brakes early.
- Monitor the temperature gauge.

Weight distribution

Towing a loaded trailer with an empty car results in a highly unstable distribution of weight. If this cannot be avoided drive at very low speeds only to avoid the risk of losing steering control.

A “balanced” rig is easier to operate and control. This means that the tow vehicle should be loaded to the extent possible and permissible while keeping the trailer as light as possible under the circumstances. Whenever possible, transfer some cargo to the luggage compart- ▶

ment of the tow vehicle while observing tongue load requirements and vehicle loading considerations.

Speed

The higher the speed, the more difficult it becomes for the driver to control the rig. Do not drive at the maximum permissible speed. Reduce your speed even more under unfavorable load, weather or wind conditions - particularly when going downhill.

Reduce vehicle speed **immediately** if the trailer shows the slightest sign of swaying. **Do not try to stop the swaying by accelerating.**

Observe speed limits. In some areas speeds for vehicles towing trailers are lower than for regular vehicles.

Always apply brakes early. When driving downhill, shift into lower gear to use the engine braking effect to slow down the vehicle. Use of the brakes alone can cause them to overheat and fail.

Coolant temperature

The coolant temperature gauge ⇒ *page 9* must be observed carefully. If the needle moves close to the upper end of the scale, reduce speed immediately and/or switch off the air conditioner.

If the coolant temperature warning light in the instrument cluster starts flashing , pull off the road, stop and let the engine *idle* for about two minutes to prevent heat build-up.

WARNING

Anyone not properly restrained in a moving vehicle is at a much greater risk in an accident. Never let anyone ride in your car who is not properly wearing the restraints provided by Audi. ■

Trailer towing tips

Important to know

Your vehicle handles differently when towing a trailer because of the additional weight and weight distribution. Safety, performance and economy will greatly depend on how carefully you load your trailer and operate your rig.

Before you actually tow your trailer, practice turning, stopping and backing up in an area away from traffic. Keep practicing until you have completely become familiar with the way your vehicle-trailer combination behaves and responds.

Backing up is difficult and requires practice. Backing up with a trailer generally requires steering action opposite of that when backing up your vehicle without a trailer.

Maintain a greater distance between your vehicle and the one in front of you. You will need more room to stop.

To compensate for the trailer, you will need a larger than normal turning radius.

When passing, remember that you cannot accelerate as fast as you normally would because of the added load. Make sure you have enough room to pass. After passing, allow plenty of room for your trailer before changing lanes again.

Avoid jerky starts, sharp turns or rapid lane changes.

Tips

- Do not tow a trailer during the break-in period of your vehicle.
- If you tow a trailer, your Audi may require more frequent maintenance due to the extra load ⇒ *page 299*. ■

Parking on a slope

Do not park with a trailer on a slope. If it cannot be avoided, do so only after doing the following:

When parking:

- Apply the foot brake.
- Have someone place chocks under both the vehicle and the trailer wheels.
- With chocks in place, slowly release the brakes until wheel blocks absorb the load.
- Turn the wheels towards the curb.
- Apply the parking brake.
- Place an automatic transmission in **P**, respectively a manual transmission in first or reverse gear.

When restarting after parking:

- Start the engine.
- Shift transmission into gear.
- Release the parking brake and slowly pull out and away from the wheel blocks.
- Stop and have someone retrieve the wheel blocks.

Tips

If you move the selector lever of the automatic transmission to **P** before applying the parking brake and before blocking the wheels, you may have to use more force later to move the lever out of the **P** position. ■

Cleaning and protection

General information

Regular care preserves vehicle value.

Any automobile is exposed to industrial fumes, corrosive road salt, etc. A well cared for Audi can look like new many years after purchase. Regular and correct care will contribute to maintaining the beauty and value of your Audi.

Furthermore, good care may be a condition for substantiating a warranty claim should corrosion damage or paint defects occur.

Your authorized Audi dealer has a variety of **dedicated vehicle-care products** and can advise which ones to use for cleaning the exterior and interior of your vehicle.

Whether you use products recommended by Audi or other commercially available cleaning agents, please make sure you apply them correctly.

WARNING

- Cleaning agents may be poisonous. Keep them out of the reach of children.
- Heed all caution labels.
- Always read directions on the container before using any product. Follow the directions carefully.
- Most chemical cleaners are concentrated and have to be diluted.
- Use spot removing fluids only in well ventilated areas.
- Do not use gasoline, kerosene, diesel fuel, nail polish remover or other volatile fluids. They may be toxic, flammable or hazardous in other ways. Do not wash, wax or dry the vehicle with the ignition on or the engine running.

WARNING (continued)

- Do not clean the undersides of chassis, fenders, wheel covers, etc. without protecting your hands and arms. You may cut yourself on sharp-edged metal parts.
- Moisture and ice on brakes may impair braking efficiency ⇒ *page 191, "General information"*. Test the brakes carefully each time you wash the vehicle.



For the sake of the environment

Select only environmentally friendly cleaning products. Leftover cleaning products should not be disposed of in the household waste. ■

Care of exterior

Washing

Frequent washing protects the vehicle.

The best protection against environmental influences is *frequent* washing and waxing.

How often this is required depends on:

- How much the vehicle is used
- Where the vehicle is parked (garage, in the open under trees, etc.)
- The seasonal and weather conditions
- Environmental influences

The longer bird droppings, insects, tree resin, road and industrial grime, tar, soot, road salt and other materials remain on the vehicle body, the more lasting their destructive effects will be. ►

High temperatures, as from exposure to intense sunlight, intensify the corrosive effect particularly when humidity is high as well.

Under certain circumstances, **weekly** washing may be necessary. Under other conditions, a monthly washing and waxing may be adequate.

After the winter, the underside of the vehicle should be thoroughly washed, preferably in a professional car wash.

WARNING

Always read and heed all WARNINGS and other information
⇒ *page 206.*

Note

You should remove debris (such as insects) from the headlight lenses on a regular basis, for example when refueling your vehicle. Never clean the headlights with a dry cloth or sponge. Use a wet cloth or sponge. It is best to use soapy water. ■

Automatic car wash

The vehicle can be washed in almost any modern automatic car wash.

The vehicle paint is so durable that the vehicle can normally be washed without problems in an automatic car wash. However, the effect on the paint depends to a large extent on the design of the facility, the filtering of the wash water, the type of wash and care material, etc. If the paint has a dull appearance after going through the car wash or is scratched, bring this to the attention of the operator immediately. If necessary, use a different car wash.

Before going through a car wash, be sure to take the usual precautions such as closing the windows and panoramic sliding sunroof*. Remove antenna if applicable.

If you have installed additional accessories on the vehicle - such as spoilers, roof rack, etc. - it is best to ask the car wash operator if these should be removed.

WARNING

Always read and heed all WARNINGS and other information
⇒ *page 206.* ■

Washing the vehicle by hand

A lot of water is needed when washing a vehicle by hand.

- Before you start washing, make sure you have read and understood the WARNINGS ⇒  in “General information” on *page 206.*
- First soak all dried dirt until it is soft, then rinse it off.
- As you clean your vehicle, start with the roof and work your way down to the bottom, using a sponge, a sponge glove or a clean brush.
- Rinse the sponge or the sponge glove often, flushing it clean each time.
- Use special car shampoo only for very persistent dirt.
- Rinse the car thoroughly with water.
- Use a chamois leather to gently wipe the exterior dry.

Use a separate sponge for cleaning the wheels, door sills and other regions exposed to road dirt. In this way, you will not scratch the paint with coarse particles imbedded in the sponge the next time you wash the car. ►

 **WARNING**

- Do not clean the underside of the chassis, fenders, wheel covers, or other hard to reach parts without protecting your hands and arms. You may cut yourself on sharp-edged metal parts.
- Always read and heed all WARNINGS and other information ⇒ *page 206*.

 **Note**

- Never try to remove dirt, mud or dust if the surface of the vehicle is dry. Never use a dry cloth or sponge, since this could scratch your vehicle's paint or windows.
- Never wash your car in bright sunlight. Drops of water act as magnifying lenses and may damage your paint.
- When you wash your car in the winter: if you rinse your vehicle with a hose, be careful not to aim the stream of water directly at locks, or at door or hatch openings - they can freeze shut.
- Never use sponges designed to remove insects, or any kitchen scouring sponges or similar products. They can damage your paint finish.
- Never use a dry cloth or sponge to clean the headlights. Only use wet cloths or sponges to prevent scratches. It is best to use soapy water.

 **For the sake of the environment**

In the interest of the environment, the vehicle should only be washed in special wash bays. ■

Washing your vehicle with a power washer

Cleaning the exterior of your car with a high-pressure power washer is safe as long as you observe a few simple rules.

- Before using the power washer, make sure you have read and understood the WARNINGS ⇒  in “General information” on *page 206*.
- Always follow the operating instructions for the power washer.
- Make sure that the jet on the spray hose produces a “fan shaped spray”.
- Do *not* hold the spray nozzle *too close* to soft materials.

When cleaning the vehicle with a power washer *always* follow the operating instructions. This applies particularly to the **operating pressure** and the **spraying distance**. Maintain a sufficient distance to soft materials such as rubber hoses and sound/vibration deadening materials (particularly on the underside of the engine hood). Do not use a jet which sprays water in a **direct stream** or one that has a **rotating** jet.

Water temperature should not exceed 140 °F (60 °C).

 **WARNING**

Never wash tires with a jet that sprays water in a direct stream. This could cause invisible damage to the tires and weaken them, even if the spray is from a relatively long distance and for a short time. Damaged and weakened tires can fail and cause accidents and personal injury.

Note

To avoid damaging your vehicle, always make sure that there is sufficient distance between the spray head and soft materials like rubber hoses, plastic parts and sound-deadening materials. Never aim the spray head at the same point for a long time. This also applies to cleaning headlights and painted bumpers. Remember: the closer the nozzle is to the surface of the material, the greater the stress on the material. ■

Waxing

Wax protects the vehicle's paint.

- Use a manually applied car wax occasionally to protect the paint.

A good wax coating protects the vehicle paint to a large extent against the environmental factors listed under ⇒ *page 206*, "Washing" and even against slight scratches.

You can use a liquid car wax to protect your paint as soon as one week after your vehicle has been delivered.

Even if you regularly use a **waxing** process in automatic car washes, we recommend that you manually apply a coat of wax to give the paint extra protection, particularly if water no longer beads on the clean paint.

Protect plastic body parts with car wax in the same way as the vehicle body.

During warm weather dead insects tend to collect on the front bumper and on the forward area of the hood. They are much easier to remove from paint that is waxed *often*.

WARNING

Always read and heed all WARNINGS and other information
⇒ *page 206*.

Note

Do not use car wax on

- matte or anodized metal trim
- rubber or rubber-like trim. ■

Polishing

Polishing restores the gloss to the paint.

Polish your vehicle only if the paint has lost its shine and the gloss cannot be brought back with wax.

If the polish used does not contain preservative compounds, the paint must be waxed afterwards ⇒ *page 209*, "Waxing".

WARNING

Always read and heed all WARNINGS and other information
⇒ *page 206*.

Note

Do not treat matte anodized metal trim, plastic or rubber parts with polish or wax. ■

Trim strips

Metal trim needs special care.

For environmental reasons, Audi fabricates the bright trim strips and trim pieces from pure chromium-free aluminum. ►

Dirt and marks on the trim strips should be removed with a **pH-balanced** cleaning agent (do not use a chrome cleaner). Authorized Audi dealers carry cleaning products which have been tested for use on your vehicle and are not harmful to the environment.

To avoid corrosion on the exterior trim strips, only a pH-balanced solution should be used for the windshield washer.

WARNING

Always read and heed all WARNINGS and other information
⇒ [page 206](#). ■

Plastic and vinyl

Plastic needs special care.

Use a clean, damp cloth or sponge to remove dust and light surface dirt. For other soil, use a lukewarm all-purpose cleaning solution or a mild saddle soap for vinyl trim. Remove water spots and traces of soap with a clean, damp cloth or sponge. Use a clean, soft cloth to rub dry.

Grease, tar or oil stains can be removed with a clean cloth or sponge soaked with all-purpose cleaner or with a solvent designed especially to clean vinyl.

Occasionally apply a colorless vinyl or leather preservative to retain the material's luster and pliability.

WARNING

Always read and heed all WARNINGS and other information
⇒ [page 206](#). ■

Aluminum trim

Use only **neutral-pH** products to remove spots and deposits from aluminum surfaces. Chrome care products and alkaline cleaners will attack aluminum surfaces and can damage them over time.

WARNING

Always read and heed all WARNINGS and other information
⇒ [page 206](#). ■

Touch-up paint

Minor paint damages should be touched up immediately.

- Use either a touch-up paint stick or spray paint to cover minor scratches and nicks.

Your authorized Audi dealer has touch-up paint for minor scratches and stone chips. Scratches should be touched up soon after they occur to prevent corrosion.

If a spot starts to rust, however, a simple touch-up job will not be enough. The affected surface must be sanded smooth and coated with an anti-rust primer before the painted finish can be restored.

The number for the original vehicle paint can be found on the vehicle identification label ⇒ [page 294](#).

WARNING

Always read and heed all WARNINGS and other information
⇒ [page 206](#). ■

Windows

Clear vision to all sides.

Clean all windows regularly to remove road film and carwash wax buildup.

- Remove snow from windows using a brush.
- Use a plastic ice scraper to remove ice from windows and mirrors.
- Remove other residue on the windows with a spray-on glass cleaner.
- Wipe the windows dry with a clean piece of cloth or kitchen paper towel.

The best way to remove snow from windows and mirrors is to use a brush. Use a non-abrasive **plastic ice scraper** - better still, a spray deicer - to remove **ice** from windows and mirrors.

The windows must not be cleaned with insect remover or wax since these can interfere with the function of the windshield wiper blades (chatter).

Oil, grease or silicone residue can be removed with **glass cleaner** or **silicone remover**. However, wax residue requires the use of a specially formulated solvent. Please contact your authorized Audi dealer for advice on safe products for wax removal.

Windows should also be cleaned on the inside at regular intervals.

Never dry windows with the same chamois that you use to dry painted surfaces. Wax residue on the chamois can impair vision through the windows.

WARNING

- The windshield must not be treated with water-repellent materials. They can increase glare under poor visibility conditions

WARNING (continued)

such as wetness, darkness, or when the sun is low on the horizon. In addition, they can cause the windshield wipers to chatter.

- Always read and heed all WARNINGS and other information ⇒ *page 206.*

Note

- Never use warm or hot water to remove snow and ice from windows and mirrors. This could cause the glass to crack.
- To prevent damage to the wires of the rear defogger, do not place any adhesive stickers on the inside of the rear window over the wires.
- To help prevent dirt from scratching the window, always scrape in a forward direction - pushing the scraper away from you - never back and forth. ■

Weatherstrips

Complete car care includes the weatherstrips as well.

- Apply a suitable rubber conditioner to the weatherstrips from time to time.

To be able seal properly, the weatherstrips around the hood, doors, rear lid, etc. must remain pliable. Spray the weatherstrips with silicone or coat them with talcum powder or glycerine to retain the flexibility of the rubber and to protect them against freezing in the winter.

WARNING

Always read and heed all WARNINGS and other information ⇒ *page 206.*

Tips

Keep silicone sprays off the windshield to avoid wiper smear in rain. ■

Applies to vehicles: with steel wheels (e.g. if refitted with winter tires)

Steel wheels

The wheels also have to be cleaned.

- Always include the hub caps and wheel rims when washing your vehicle to remove road dirt, salt sprays and brake dust.

If necessary, use a commercial wheel cleaner to remove accumulated brake dust.

The wheel rims are easier to keep clean if they are regularly coated with liquid wax.

Paint scratches should be touched up as soon as possible to prevent corrosion ⇒ *page 210*, “Touch-up paint”.

WARNING

- **Moisture and ice on brakes may affect braking efficiency** - ⇒ *page 191*, “General information”. Test the brakes carefully after each vehicle wash.
- **Always read and heed all WARNINGS and the information** ⇒ *page 206*. ■

Applies to vehicles: with Cast alloy wheels

Cast (light) alloy wheels

Cast (light) alloy wheels require special care.

- Wash the wheels with a sponge or hose brush every other week.

- For deep cleaning afterwards, use only a dedicated **acid-free** cast alloy wheel cleaner.
- Rub a coat of **liquid wax** onto the rims every three months. Be sure to reach and treat all parts of the rim.

To preserve the decorative appearance of the cast alloy wheels, some special care is necessary. In addition to road dirt and salt, brake dust is also corrosive. If left on for too long, brake dust can cause pitting.

Use only special *acid-free* cleaners formulated for alloy rims. Safe products are available at your authorized Audi dealer. Never leave the cleaner on the rims longer than specified on the label. If not rinsed off promptly, the acid contained in some cleaners can attack the threads on the wheel bolts.

Never use abrasive or metal polishing cleaning agents. If the protective coating has been chipped, e.g. by kicked up road dirt, touch it up as soon as possible.

WARNING

- **Moisture and ice on brakes may affect braking efficiency** ⇒ *page 191*, “General information”. Test the brakes carefully each time you wash the vehicle.
- **Always read and heed all WARNINGS and other information** ⇒ *page 206*. ■

Body cavity sealing

The body cavity sealing does not need to be checked.

All body cavities which could be affected by corrosion have been thoroughly protected at the factory.

This sealing does not require any inspection or additional treatment. If any wax should seep out of the cavity when the ambient temperature is high, it can be removed with a plastic scraper and a suitable solvent. ▶

WARNING

Solvents can be dangerous.

- Benzine is flammable and toxic. If you use benzine for removing the wax, keep sparks, flame and lighted cigarettes away. Never dump benzine on the ground, into open streams or down sewage drains.
- Be sure to observe all safety and environmental regulations. Follow all instructions on the container.
- Always read and heed all WARNINGS and other information ⇒ page 206. ■

Chassis

Have the undercoating checked for damage from time to time.

The lower body shell of your Audi is also thoroughly protected against corrosion.

Any damage to the undercoating caused by road hazards should be repaired promptly.

WARNING

Too much undercoating in the wrong places can cause a fire.

- Do not apply additional undercoating or rustproofing on or near the exhaust manifold, exhaust pipes, catalytic converter or heat shields. While driving, the substance used for undercoating could overheat and cause a fire.
- Always read and heed all WARNINGS and other information ⇒ page 206. ■

Exhaust tail pipes

Road salt and other corrosive materials will damage the material in the exhaust tail pipes if they are not cleaned regularly. Do not clean the tail pipes with wheel cleaner, paint polish, chrome polish or other abrasive cleaners. Clean the tail pipes with car care products that are suitable for stainless steel.

Your authorized Audi dealer can provide cleaning products that have been tested and approved for your vehicle. ■

Care of interior

Aluminum trim

Use only **neutral-pH** products to remove spots and deposits from aluminum surfaces. Chrome care products and alkaline cleaners will attack aluminum surfaces and can damage them over time.

WARNING

Always read and heed all WARNINGS and other information ⇒ page 206. ■

Fabrics and fabric coverings

Fabrics and fabric coverings (e.g. seats, door trim panels, etc.) should be cleaned at regular intervals with a vacuum cleaner. This removes surface dirt particles which could become embedded in the fabric through use. Steam cleaners should not be used, because the steam tends to push the dirt deeper into the fabric and lock it there.

Normal cleaning

Generally, we recommend using a soft sponge or a lint-free microfiber cloth to clean fabric. Brushes should only be used for ►

carpets and floor mats, since other fabric surfaces could be harmed by brushes.

Normal surface stains can be cleaned using a commercially available foam cleaner. Spread the foam on the surface of the fabric with a soft sponge and work it in gently. Do not saturate the fabric. Then pat the foam dry using absorbent, dry cloths (e.g. microfiber cloth) and vacuum it after it has dried completely.

Cleaning stains

Stains caused by beverages (e.g. coffee, fruit juice, etc.) can be treated with a mild detergent solution. Apply the detergent solution with a sponge. In the case of stubborn stains, a detergent paste can be applied directly to the stain and worked into the fabric. Afterwards, use copious amounts of clean water to remove the remaining detergent. Apply the water with a damp cloth or sponge and pat the fabric dry with an absorbent, dry cloth.

Stains from chocolate or makeup should have detergent paste (e.g. ox-gall soap) rubbed into them. Afterwards, remove the soap with water (damp sponge).

Alcohol can be used to treat stains from grease, oil, lipstick or a ball-point pen. Melted grease or dye must be patted off using absorbent material. It may be necessary to retreat the areas with detergent paste and water.

In the case of general soiling of the upholstery and cover material, we recommend hiring a specialist that has the equipment to clean the seat covers and other fabric surfaces by shampooing and spray extraction.

WARNING

Always read and heed all WARNINGS and the information
⇒ *page 206.*

Tips

Open Velcro fasteners on your clothing can damage the seat cover. Please make sure that Velcro fasteners are closed. ■

Plastic parts and instrument panel

– Always use a clean cloth moistened in clear water.

Always use a clean cloth moistened in clear water to clean these areas. For persistent dirt use an Audi approved **solvent-free** plastic cleaner/protectant.

WARNING

Solvents can change the properties of some plastics and make it harder for the airbag to deploy.

- **Never clean the instrument panel or the surface of Airbag modules with cleaning products that contain solvents.**
- **Products containing solvents will make the surface of this part porous.**
- **Serious injuries can result if plastic parts come loose when the airbag is deployed.**
- **Always read and heed all WARNINGS and the information**
⇒ *page 206.*

Note

Cleaning agents containing solvents will attack the material and can change the way it behaves. ■

Applies to vehicles: with natural leather

Natural leather

Audi makes great efforts to maintain the properties, natural look and feel of interior leather.

General

We offer many different types of leather on our vehicles. Most are different types of nappa leather, which has a smooth surface and comes in various colors.

The intensity of the color determines the visual characteristics and appearance. If the surface of the leather has a typical natural look, then the leather is a nappa leather that has been left in a relatively natural condition. This leather offers particularly good comfort and breathes well. Fine veins, closed grains, insect bites, skin folds, and subtle variations in color remain visible. These characteristics demonstrate that the material is natural.

Natural nappa leather is not covered by a color finish. It is therefore more sensitive to soiling and wear, which is something you need to consider if children, animals or other factors might prove to be particularly hard on the leather.

By contrast, leather types that are covered by a colored finish layer are more durable. This has a positive effect on the leather's resistance to wear and soiling in daily use. On the other hand, the typical characteristics of natural leather are barely or not apparent. However, this does not mean that the leather itself is of inferior quality.

Care and handling

Because of the exclusive nature of the types of leather that Audi uses and their unique properties (such as sensitivity to oils, grease, soiling, etc.), you will need to be somewhat careful with these leathers, and a certain type of care is required. For example, dark clothing materials can discolor leather seats (especially if such clothing is damp and was not dyed correctly). Dust and dirt particles in pores, folds, and seams can have an abrasive effect and can damage the leather surface as well as weaken seams.

The leather should be cleaned regularly as needed. After having been used for a relatively long time, your leather seats will acquire a rich aged finish. This is a characteristic of natural leather and a sign of true quality.

In order to maintain the value of this natural product over the life of your vehicle, you should follow the recommendations below:

Note

- To keep your leather from bleaching out, do not allow it to be exposed to bright sunlight for long periods of time. If you have to leave the vehicle parked outside for long periods, cover the leather to protect it from direct exposure to sunlight.
- Sharp objects on clothing, such as zippers, rivets or sharp pieces on belts can leave permanent scratches or scrape marks on the surface of the leather.

Tips

- After each time you clean the leather and at regular intervals, use a leather preservative creme that contains UV-blockers and that works into the leather. This creme will nourish and moisturize the leather, helping it to breathe and stay supple. It also helps to build up a protective coating on the surface.
- Clean the leather every 2 - 3 months, and clean any areas that get soiled.
- Remove fresh marks made by ballpoint pens, ink, lipstick, shoe polish, etc. as soon as possible.
- Preserve the color of the leather as needed by using a special colored leather care creme to touch up areas of uneven color. ■

Applies to vehicles: with natural leather

Cleaning and caring for leather upholstery and trim

Natural leather requires special care and attention.

Normal cleaning

- Clean soiled areas with a slightly moistened cotton or woolen cloth.

More stubborn dirt

- More stubborn dirt can be removed using a cloth saturated with a mild soap solution (2 tablespoons mild liquid soap).
- Never allow the soap solution to saturate the leather, and make certain that no water soaks into the seams.
- Wipe off the soap solution with a soft, dry cloth.

Cleaning spots

- Remove fresh **water-based** spots (such as coffee, tea, juices, blood) with an absorbent cloth or paper towel.
- Remove fresh **grease or oil-based spots** (such as butter, mayonnaise, chocolate) with an absorbent cloth or paper towel, or use the cleaner from the leather care kit if the spot has not yet penetrated into the surface of the leather.
- Use an oil/grease dissolving spray, if **oil/grease spots have dried on**.
- Remove specific kinds of spots (ballpoint pen, felt marker, fingernail polish, water-based paint, shoe polish, etc.) with a spot remover specifically formulated for leather.

Leather care

- Every half year use an approved leather care product (available from your authorized Audi dealer) to care for the leather.
- Apply the product very sparingly.
- Wipe it off with a damp cloth.

If you have any questions about cleaning and caring for the leather in your vehicle, it is best to contact your authorized Audi dealer, who will be glad to help you and tell you about our full range of leather care products, such as:

- Leather cleaning and care kit
- Creams to care for colored leather
- Spot removers for ballpoint pens, shoe polish, etc.
- Oil/grease dissolving spray
- New and upcoming products.

WARNING

Always read and heed all WARNINGS and other information
⇒ page 206.

Note

- Never use chemical solvents (e.g. lighter fluid, turpentine), waxes, shoe polish or similar products on the leather surfaces in your Audi.
- To avoid damage, have stubborn stains removed by a commercial cleaning specialist. ■

Applies to vehicles: with Alcantara upholstery

Cleaning Alcantara® (synthetic suede)

Removing dust and dirt

- Moisten a cloth, *squeeze out excess water* and wipe down the seat surfaces.

Removing stains

- Moisten a cloth with lukewarm water or with diluted **ethyl (rubbing) alcohol**.
- Dab at the stain. Start at the outside and work inwards.
- Once the stain is no longer visible, use a soft dry cloth or tissue to soak up the moisture.

Do not use leather cleaning products on Alcantara.

You may use a suitable shampoo for removing dust and dirt.

Dust and grit in the pores and seams can scratch and damage the surface. If the car is left standing in the sun for long periods, the Alcantara should be protected against direct sunlight to prevent it from fading. Slight color variations will develop in normal use and are not an indication of material deterioration.

Note

- Never use chemical solvents (e.g. lighter fluid, turpentine), waxes, shoe polish or similar products on Alcantara® surfaces.
- To avoid damage, have stubborn stains removed by a commercial cleaning specialist.
- Do not use brushes, stiff sponges or similarly abrasive cleaning aids. ■

Safety belts

Only well-maintained safety belts work reliably when needed.

- Keep belts clean.
- For cleaning, use a mild soap and water solution. Let belts dry thoroughly and away from direct sunlight.
- Do not allow inertia reel safety belts to retract before they are completely dry.
- Check the condition of your safety belts *regularly*.

Heavily soiled safety belts may not retract properly.

WARNING

Damaged safety belts can break in a crash.

- Anything that might damage your safety belts could mean that you and your passengers would not be adequately protected in an accident.
- Safety belt performance depends on correct installation. Never remove belts from the vehicle to clean them.
- Do not use chemical cleaning agents, bleach or dyes. They have corrosive properties which weaken the webbing.
- When cleaning your safety belts, inspect them for damage. If you discover damage, see your authorized Audi dealer.
- Always read and heed all WARNINGS and other information ⇒ *page 206*. ■

Engine compartment

Be especially careful when cleaning the engine compartment.

Always switch off the ignition before cleaning the engine ⇒ .

Plenum panel

Remove leaves from the plenum panel in front of the windshield under the engine hood. This prevents the water drain holes from becoming blocked, and it prevents debris from entering the vehicle interior through the heating and ventilation ducts.

Corrosion protection

The engine compartment and transmission have been corrosion-protected at the factory.

Good anti-corrosion treatment is very important, particularly in the winter. If the vehicle is frequently driven on salt treated roads, the entire engine compartment and plenum panel should be thoroughly cleaned at the end of winter and retreated to prevent salt damage. At the same time, the underside of the vehicle should be washed as well.

If the engine compartment is cleaned at any time with grease removing solutions⁵⁾, or if you have the engine washed, the anti-corrosion treatment is almost always removed as well. It is therefore essential to have a long-lasting corrosion protection reapplied to all surfaces, seams, joints and components in the engine compartment.

WARNING

Be aware: The engine compartment of any motor vehicle is a potentially hazardous area.

- Before working in the engine compartment, be sure to read the information ⇒ *page 218*.

WARNING (continued)

- Before reaching into the front plenum panel, always remove the ignition key. Otherwise, the windshield wiper system could unintentionally be switched on, possibly causing personal injury from the moving wiper linkage.
- Never reach into the area around or touch the radiator fan. The auxiliary fan is temperature controlled and can switch on suddenly - even when the ignition is off.
- Do not wash, wax or dry the engine with the engine running. Moving or hot parts could injure you.
- Do not clean the underside of the chassis, fenders, wheel covers, or other hard to reach parts without protecting your hands and arms. You may cut yourself on sharp-edged metal parts.
- Always read and heed all WARNINGS and other information ⇒ *page 206*. ■

⁵⁾ Use only the correct cleaning solutions. Never use gasoline or diesel fuel.

Fuel supply and filling your fuel tank

Gasoline

Fuel supply

Using the right fuel helps keep the environment clean and prevents engine damage.

Fuel recommendation

The fuel recommended for your vehicle is **unleaded premium** grade gasoline. See also ⇒ *page 296, "Data"*. Audi recommends using TOP TIER Detergent Gasoline with a minimum octane rating of 91 AKI (95 RON). For more information on TOP TIER Detergent Gasoline, please go to the official website (www.toptiergas.com).

The recommended gasoline octane rating for your engine can also be found on a label located on the inside of the fuel filler flap. This rating may be specified as AKI or RON.

Your vehicle may also be operated using unleaded regular gasoline with a minimum octane rating of 87 AKI/91 RON. However, using 87 AKI/91 RON octane fuel will slightly reduce engine performance.

Use unleaded gasoline only. Unleaded gasoline is available throughout the USA, Canada, and in most European countries. We recommend that you do not take your vehicle to areas or countries where unleaded gasoline may not be available.

For more information on refueling your vehicle, see ⇒ *page 221*.

Octane rating

Octane rating indicates a gasoline's ability to resist engine damaging "knock" caused by premature ignition and detonation. Therefore, buying the correct grade of gasoline is very important to help prevent possible engine damage and a loss of engine performance.

Gasoline most commonly used in the United States and Canada has the following octane ratings that can usually be found on the filler pump:

- Premium Grade: 91 - 96 AKI
- Regular Grade: 87 - 90 AKI

Explanation of the abbreviations:

AKI = **A**nti **K**nock **I**ndex = $(R+M)/2 = (RON+MON)/2$

RON = **R**esearch **O**ctane **N**umber

MON = **M**otor **O**ctane **N**umber.

Note

- Do not use any fuel with octane ratings lower than 87 AKI or 91 RON otherwise expensive engine damage will occur.
- Do **not** use leaded gasoline! The use of leaded gasoline will severely damage your vehicle's catalytic converter and its ability to control exhaust emissions. ■

Blended gasoline

Use of gasoline containing alcohol or MTBE (methyl tertiary butyl ether)

You may use unleaded gasoline blended with alcohol or MTBE (commonly referred to as oxygenates) if the blended mixture meets the following criteria:

Blend of gasoline methanol (wood alcohol or methyl alcohol)

- Anti-knock index must be 87 AKI or higher.
- Blend must contain no more than 3% methanol.
- Blend must contain more than 2% co-solvents.

Blend of gasoline and ethanol (grain alcohol or ethyl alcohol)

- Anti-knock index must be 87 AKI or higher.
- Blend must not contain more than 10% ethanol.

Blend of gasoline and MTBE

- Anti-knock index must be 87 AKI or higher.
- Blend must contain not more than 15% MTBE.

Seasonally adjusted gasoline

Many gasoline grades are blended to perform especially well for winter or summer driving. During seasonal change-over, we suggest that you fill up at busy gas stations where the seasonal adjustment is more likely to be made in time.

Note

- Methanol fuels which do not meet these requirements may cause corrosion and damage to plastic and rubber components in the fuel system.
- Do not use fuels that fail to meet the specified criteria in this chapter.
- If you are unable to determine whether or not a particular fuel blend meets the specifications, ask your service station or its fuel supplier.
- Do not use fuel for which the contents cannot be identified.
- Fuel system damage and performance problems resulting from the use of fuels different from those specified are not the responsibility of Audi and are not covered under the New Vehicle or the Emission Control System Warranties.
- If you experience a loss of fuel economy or driveability and performance problems due to the use of one of these fuel blends, we recommend that you switch to unblended fuel. ■

Gasoline additives

A major concern among many auto manufacturers is carbon deposit build-up caused by the type of gasoline you use.

Although gasoline grades differ from one manufacturer to another, they have certain things in common. All gasoline grades contain substances that can cause deposits to collect on vital engine parts, such as fuel injectors and intake valves. Although most gasoline brands include additives to keep engine and fuel systems clean, they are not equally effective.

Audi recommends using TOP TIER Detergent Gasoline. For more information on TOP TIER Detergent Gasoline, please go to the official website (www.toptiergas.com).

After an extended period of using inadequate fuels, built-up carbon deposits can rob your engine of peak performance.

Note

Damage or malfunction due to poor fuel quality is not covered by the Audi New Vehicle Limited Warranty. ■

Applies to vehicles: with diesel engine

Diesel fuel

Always use ULSD (Ultra Low Sulfur Diesel) sulfur content 15 ppm or less.

The ULSD (Ultra Low Sulfur Diesel) meets the ASTM-D-975 (grade 2).

Diesel fuel with a higher concentration than ULSD-Diesel No. 2 ASTM D975 and Bio-diesel with a higher concentration than 5 % like B11, B20 or B100 are strictly prohibited.

Service station fuel pumps are labeled with the correct fuel information for easy recognition by the user. If the diesel fuel pump is not labeled ask the station operator what fuel is being dispensed before filling up your vehicle.

Service stations offering diesel fuel are generally located on truck routes or major highways. Directories of diesel fuel stations are usually available at diesel fuel stations. ►

Some states in the USA require permits to purchase diesel fuel. Check with your State Motor Vehicle Department.

Diesel fuel may not be available outside the USA and Canada. Be sure to check before traveling to other countries.

Winter operation

At temperatures below 20° F (-7° C), Diesel fuel No. 2 loses its fluidity due to wax separation, which may clog the fuel filter or tank filter and keep the engine from running.

To help the filter from being clogged by wax, the fuel filter in your vehicle is automatically preheated. Preheating the fuel filter makes operation of your vehicle possible with Diesel fuel No. 2 down to -10° F (-24° C).

If you expect temperatures below 5° F (-15° C) ask your fuel dealer whether their Diesel fuel No. 2 is sufficiently winterized for the prevailing and expected temperatures.

If not winterized or insufficiently winterized diesel fuel has already thickened to the extent that the engine will not start, warm the vehicle up by leaving it in a heated garage.

It is normal that the engine noise level (dieseling) is louder during the warm-up period in winter. It is also normal when whitish-blue smoke comes out of the tailpipe after starting and during warm-up. The amount of smoke depends on the outside temperature.

Do not let your diesel engine idle unnecessarily after a cold start. Driving off slowly will shorten the warm-up period.

WARNING

- **Never use “starting assist fluids.” They may be potentially explosive or cause a “run-away” engine condition. This could result in serious engine damage and personal injury.**
- **Never use fuel line anti-freeze offered for gasoline engines.**

Note

- Your diesel engine has been specifically designed to operate only on Ultra Low Sulfur Diesel fuel. Therefore, never use home heating oil or regular gasoline. The properties of these fuels may cause serious damage to the fuel injection system and to the engine. Using these fuels can cause expensive engine repairs and will also adversely affect your New Vehicle Limited Warranty.
- If diesel fuel should get on any rubber hose, it must be wiped off immediately. Then wash the contaminated hose portion with soap and warm water. Do not allow diesel fuel to remain on connecting hoses. They may develop leaks and cause serious damage. ■

Fuel tank

Fuel filler neck

The fuel filler neck is located on the right rear side panel behind the fuel filler flap.

If the power locking system should fail, you can still open the flap manually - for detailed instructions see ⇒ *page 224*.

You can find the fuel tank capacity of your vehicle in **Technical Data** ⇒ *page 296*.

The label on the inside of the fuel filler flap tells you the correct fuel for your vehicle. For more information about fuel specifications, see ⇒ *page 219*.

Your vehicle fuel tank has an on-board refuelling vapor recovery system. This feature helps to prevent fuel vapors from escaping from the tank and polluting the environment while you refuel your vehicle. In order to fill the tank properly while protecting the environment, please follow this refueling procedure carefully. ►

WARNING

Under normal operating conditions, never carry additional fuel containers in your car. Gas canisters and other containers used to transport fuel can be dangerous. Such containers, full or empty, may leak and could cause a fire in a collision. If you must transport fuel to use for your lawn mower, snow blower, etc., be very careful and always observe local and state laws regarding the use, transportation and storage of such fuel containers. Make certain the container meets industry standards (ANSI/ASTM F852 - 86).

Note

Never drive your vehicle until the fuel tank is completely dry. The irregular supply of fuel can cause misfiring. Gasoline could enter into the exhaust system and damage the catalytic converter. ■

Refuelling

The fuel filler flap is unlocked from a button in the driver's door.

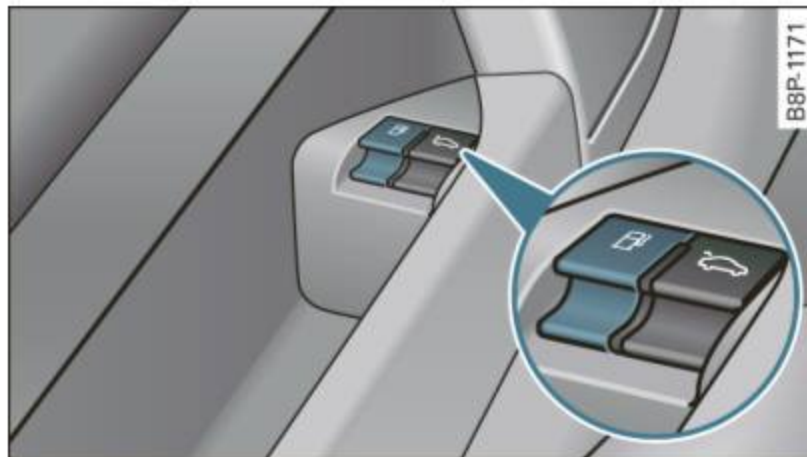

Fig. 156 Driver's door: Unlocking fuel filler flap



Fig. 157 Fuel cap hooked on the opened fuel filler flap

When adding fuel, the ignition and any cellular phones in the vehicle must be switched *off*.

Taking the fuel cap off

- To open the fuel filler flap, pull the button ⇒ fig. 156.
- Unscrew fuel filler cap counter-clockwise and hang it on the fuel filler flap ⇒ fig. 157.
- Check the label on the inside of the fuel filler flap to determine if the vehicle must be fueled with gasoline or diesel fuel.

Refuelling procedure

- Insert the fuel nozzle from the gasoline pump into the fuel filler neck as far as it will go.
- Select a medium refuelling rate so that the nozzle switches off automatically when the tank is full.

Putting the fuel cap back on

- After filling your tank, twist the fuel filler cap clockwise until you hear a definite click.
- Close the fuel filler flap.

To avoid fuel spilling or evaporating from the fuel tank always close fuel filler cap properly and completely. An improperly closed fuel filler cap may also cause a message in the driver information system or cause the MIL lamp ⇒ *page 20* to come on.

WARNING

Improper refueling or handling of fuel can cause fire, explosion and severe burns.

- Fuel is highly flammable and can cause severe burns and other injuries.
- Failure to shut the engine off while refueling and/or to insert the pump nozzle fully into the fuel filler neck could cause fuel to spray out of filler neck or to overflow. Fuel spray and overflowing fuel can cause a fire.
- Never use a cellular telephone while refueling. The electromagnetic radiation can cause sparks that can ignite fuel vapors and cause a fire.
- Never get back into your vehicle while refueling. If in exceptional circumstances you must get back in your vehicle while refueling, make certain that you close the door and touch metal to discharge static electricity before touching the filler nozzle again. Static electricity can cause sparks that can ignite fuel vapors released during refueling.
- Never smoke or have an open flame anywhere in or near your vehicle when refueling or filling a portable fuel container.
- For your safety, we strongly recommend that you do not travel with a portable fuel container in your vehicle. The container, full or empty may leak and could cause a fire, especially in a crash.
- If, under exceptional circumstances, you must transport a portable fuel container, please observe the following:
 - Never fill a portable fuel container while it is anywhere in or on the vehicle (for example, in the luggage compartment, or on the trunk). Static electricity can build up while filling and can ignite fuel vapors causing a fire.

WARNING (continued)

- Always place a portable fuel container on the ground before filling.
- Always keep the filler nozzle completely inside the portable container before and during filling.
- If filling a portable container made of metal, the filler nozzle must always be in contact with the container. This will help prevent static electricity from discharging and cause a fire.
- Never spill fuel inside the vehicle or luggage compartment. Fuel vapors are highly flammable.
- Always observe local and state/provincial laws regarding the use, storage and transportation of fuel containers.
- Make certain the fuel container meets industry standards (ANSI / ASTM F852-86).

Note

- If any fuel has spilled onto the car, it should be removed immediately to prevent damage to the paint.
- If the fuel tank runs completely empty in a vehicle with a **diesel engine**, the ignition must remain switched on for at least 30 seconds after refueling before starting the engine. It may take longer than usual for the engine to start, even up to a minute. This is because the air must first bleed out of the fuel system when starting the engine.

For the sake of the environment

As soon as the correctly operated nozzle switches off automatically for the first time, the tank is full. Do not try to add more fuel because fuel may spill out. In addition, the expansion space in the fuel tank will be filled - causing the fuel to overflow when it becomes warm and pollute the environment. ▶

Tips

- Running your engine while refuelling may cause vapors to escape or even fuel to spill out of the tank. This would then shut off the fuel nozzle before the tank is full.
- Do not refuel your vehicle with the ignition switched on. The fuel gauge may otherwise not indicate the correct fuel level after refuelling. ■

Unlocking the fuel filler flap by hand

You can open the fuel filler flap by hand if the power locking system should fail.

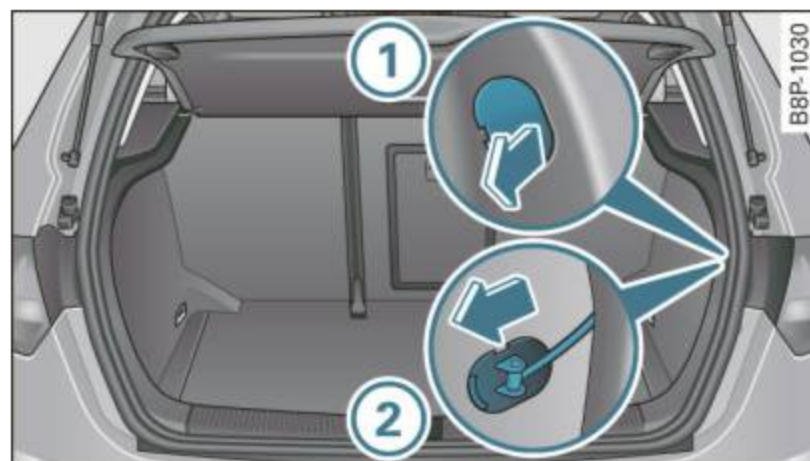

Fig. 158 Inside the luggage compartment: Opening the fuel filler flap by hand

- Open the rear lid.
- Remove the screwdriver from the vehicle tool kit
⇒ page 270.
- Use the screwdriver (vehicle tool kit) to pry the cover off at the recess ⇒ fig. 158 ①.
- Pull the actuator in the direction of arrow ② to release the fuel filler flap ⇒ fig. 158.
- Open the fuel filler flap. ■

Checking and filling

Engine hood

Releasing the engine hood

The engine hood is released from inside the vehicle.

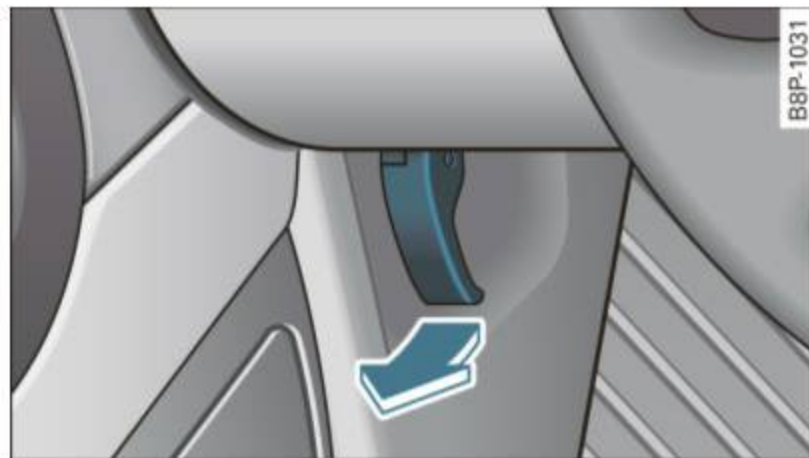

Fig. 159 Driver's side footwell: engine hood release lever

- Open the driver's door.
- Pull the release lever on the left under the instrument panel ⇒ fig. 159 in direction of the arrow.

The hood pops up slightly under spring pressure. ■

Opening the engine hood



Fig. 160 Engine hood release lever

Before opening the engine hood, make sure that the windshield wipers are folded flat against the windshield. Otherwise, they could damage the paint on the hood.

- Pull the release lever ⇒ fig. 160 in the direction indicated by the arrow. This releases the hook under the hood.
- Open the hood all the way.

WARNING

Hot engine coolant can burn you!

- To reduce the risk of being burned, never open the hood if you see or hear steam or coolant escaping from the engine compartment. Wait until no steam or coolant can be seen or heard before carefully opening the hood. ■

Closing the engine hood

- Pull the hood down until the pressure from the strut is reduced.
- Let the hood *drop down* and latch in place. *Do not try to push it shut*; it may fail to engage ⇒ .

WARNING

A hood that is not completely latched could fly up and block your view while driving.

- When you close the engine hood, check it to make sure the safety catch has properly engaged. The hood should be flush with the surrounding vehicle body parts.
- If you notice while driving that the hood is not secured properly, stop at once and close it. ■

Working in the engine compartment

Be especially careful whenever you work in the engine compartment!

Whenever you must perform any work in the engine compartment, for example checking and filling different fluids, there is a risk of injury, burns and accidents. To prevent personal injury always observe the following WARNINGS. The engine compartment of any vehicle is a hazardous area! ⇒ .

WARNING

To help avoid injury, before you check anything under the hood:

- Turn off the engine.
- Remove the ignition key.
- Set the parking brake fully.

WARNING (continued)

- Move selector lever of automatic transmission to “P” (Park); put manual transmission in Neutral.
- Always let the engine cool down. Hot components will burn skin on contact.
- To reduce the risk of being burned, never open the hood if you see or hear steam or coolant escaping from the engine compartment. Wait until no steam or coolant can be seen or heard before carefully opening the hood.
- Keep children away from the engine compartment.
- Never spill fluids on hot engine components. They can cause a fire.
- Never touch the radiator fan. The auxiliary electric fan is temperature controlled and can switch on suddenly.
- Never open the coolant reservoir cap when the engine is still warm. The coolant system is pressurized and hot coolant could spray out!
- Protect your face, hands and arm from steam or hot engine coolant by placing a thick rag over the cap when you open the coolant reservoir.
- If work on the fuel system or the electrical system is necessary:
 - Always disconnect the battery.
 - Never smoke or work near heaters or open flames. Fluids in the engine compartment could start a fire.
 - Keep an approved fire extinguisher immediately available.
- To avoid electrical shock and personal injury while the engine is running or being started, never touch:
 - Ignition cables
 - Other components of the high voltage electronic ignition system.
- If you must perform a check or repair with the engine running: ►

⚠ WARNING (continued)

- First, fully apply the parking brake, move selector lever of automatic transmission to “P” (Park); put manual transmission in Neutral.
- Always use extreme caution to prevent clothing, jewelry, or long hair from getting caught in the radiator fan, V-belts or other moving parts, or from contacting hot parts. Tie back hair before starting, and do not wear clothing that will hang or droop into the engine.
- Minimize exposure to emission and chemical hazards ⇒ ⚠.

⚠ WARNING

California Proposition 65 Warning:

- Engine exhaust, some of its constituents, and certain vehicle components contain or emit chemicals known to the State of California to cause cancer and birth defects and reproductive harm. In addition, certain fluids contained in vehicles and certain products of component wear contain or emit chemicals known to the State of California to cause cancer and birth defects or other reproductive harm.
- Battery posts, terminals and related accessories contain lead and lead compounds, chemicals known to the State of California to cause cancer and reproductive harms. Wash hands after handling.

! Note

When adding fluids, always make sure that they are poured into the proper container or filler opening, otherwise serious damage to vehicle systems will occur.

🌸 For the sake of the environment

To detect leaks in time, inspect the vehicle floor pan from underneath regularly. If you see spots from oil or other vehicle fluids, have your vehicle inspected by an authorized Audi dealer. ■

Engine compartment

Applies to vehicles: with 2.0 l turbo, 4-cylinder engine

2.0 liter, 4-cylinder turbo gasoline engine (200 hp)

These are the most important items that you can check.

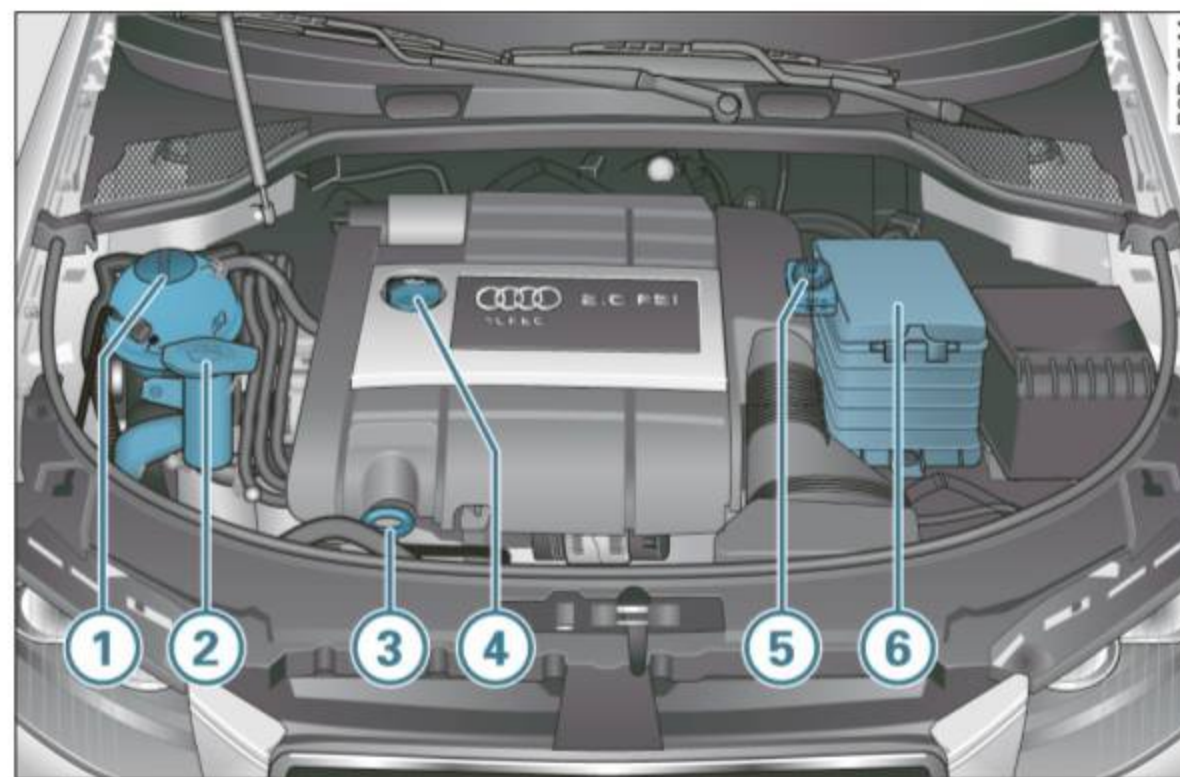

Fig. 161 Engine compartment: 2.0 l, 4-cylinder turbo

①	Coolant expansion tank (📊)	235
②	Windshield washer container (🚿)	243
③	Engine oil dipstick (orange)	231 ▶

④ Engine oil filler cap (🛢️)	232
⑤ Brake fluid reservoir (🚰)	237
⑥ Battery	238

⚠️ WARNING

Before you check anything in the engine compartment, always read and heed all WARNINGS ⇒ ⚠️ in “Working in the engine compartment” on page 226. ■

Applies to vehicles: with 2.0 l TDI, 4-cylinder diesel-engine

2.0 liter, 4-cylinder turbo diesel engine (140 hp)

These are the most important items that you can check.

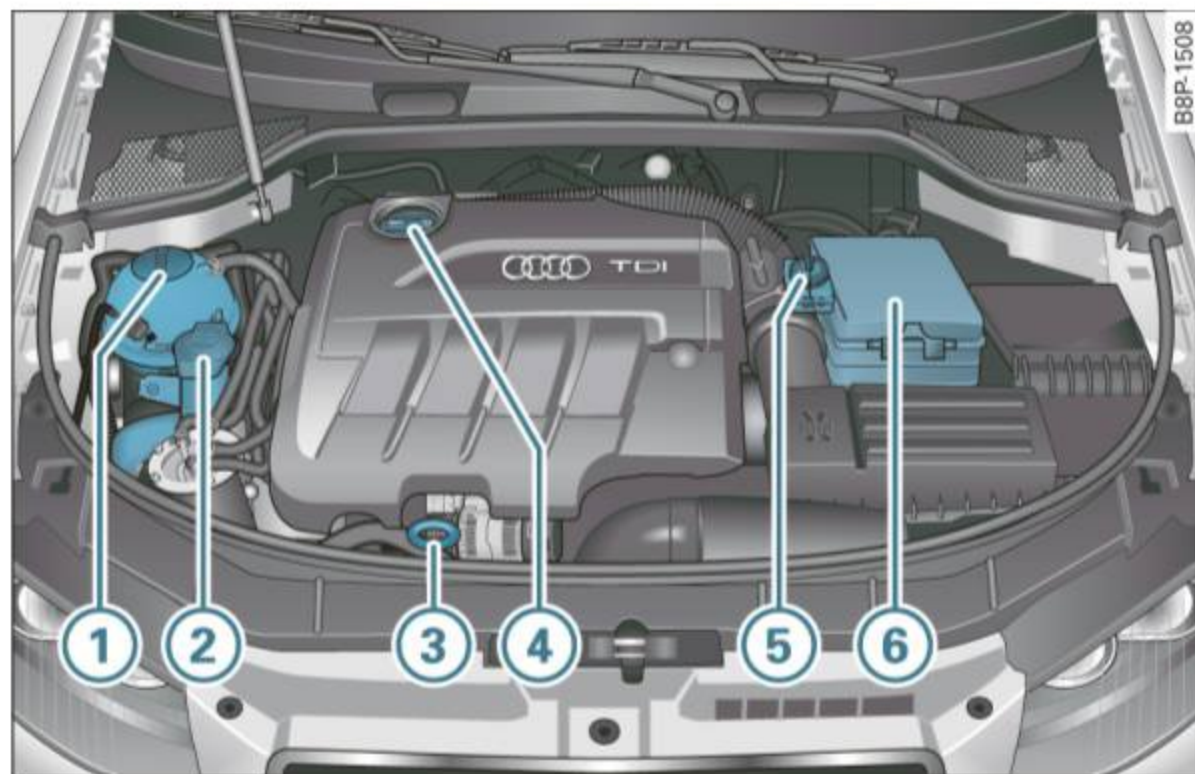

Fig. 162 Engine compartment: 2.0 l, 4-cylinder turbo

① Coolant expansion tank (🚰)	235
② Windshield washer container (🛢️)	243

③ Engine oil dipstick (orange)	231
④ Engine oil filler cap (🛢️)	232
⑤ Brake fluid reservoir (🚰)	237
⑥ Battery	238

⚠️ WARNING

Before you check anything in the engine compartment, always read and heed all WARNINGS ⇒ ⚠️ in “Working in the engine compartment” on page 226. ■

Engine oil

Engine oil specifications

The engine oil used in your Audi needs the right kind of oil.

The engine in your Audi is a sophisticated powerplant that was built to exacting specifications. This engine needs the right kind of engine oil that meets specifications regarding quality and viscosity so that it can run smoothly and reliably. Choosing the right oil and changing oil within the time and mileage intervals printed in your vehicle's Warranty & Maintenance booklet matters a lot more today than it did years ago. Audi has developed a special quality standard for engine oil that will help assure that your vehicle's engine will get the lubrication it needs for proper operation.

Modern engine lubrication has taken a quantum leap in the last few years. Many synthetic oils available today provide better engine lubrication that can outlast traditional petroleum-based oils, making them a smart choice for use throughout the life of your Audi.

Whether you use synthetic or petroleum-based engine oil, the oil that you use must conform to Audi's oil quality standard VW 502 00 (vehicles with gasoline engine) and VW 507 00 (vehicle with diesel engine) to help keep your vehicle's engine running smoothly and help ►

prevent the formation of harmful deposits, sometimes called “sludge,” that over time can lead to expensive repairs.

At the time of printing, engine oils available in the U.S. and Canada that meet the exacting specifications of Audi oil standard VW 502 00 (vehicles with gasoline engine) and VW 507 00 (vehicles with diesel engine) are synthetic engine oils. This does not mean, however, that every synthetic engine oil will meet Audi oil standard VW 502 00 (gasoline engines) and VW 507 00 (diesel engines). So always be sure that you use an approved oil.

To help prevent the formation of harmful deposits use only oil with the following specifications printed on the oil container:

- **Gasoline engines: Audi oil standard VW 502 00**
- **Diesel engines: Audi oil standard VW 507 00**

Oil container labels may carry the specification singly or in combination with other designations and oil quality standards.

Viscosity

Engine oils are graded according to their viscosity. The proper viscosity grade oil for your engine depends on climactic or seasonal conditions where you drive. You can use oil with a viscosity grade of SAE 5W-40 across all temperature ranges for normal driving conditions.

However, if engine oil viscosity grade SAE 5W-40 is not available, you can also use viscosity grade SAE 5W-30 or SAE 0W-40 as long as it meets Audi oil quality standard VW 502 00 (vehicles with gasoline engine) or VW 507 00 (vehicles with diesel engine) specifications.

Because engine oil that meets the Audi oil standard may not be available everywhere when you need it, we strongly recommend that you always carry with you an extra quart (liter) of oil that expressly conforms to the VW 502 00 (vehicles with gasoline engine) or VW 507 00 (vehicles with diesel engine) specification, in case you have to top off the oil while on the road.

Applies to vehicles with gasoline engine only: Only if the level of the oil is at or below the minimum mark on the oil dipstick - and no oil

that expressly conforms to Audi oil standard VW 502 00 specifications is available - may you top off with a high quality engine oil, preferably synthetic-based, that meets ACEA A3, ACEA A5, ACEA B5 or API SL specifications, but even then, only in viscosity grades SAE 5W-40, SAE 5W-30, or SAE 0W-40. However, during the entire time between oil change intervals, never top off with more than a total of 0.5 qt/liter engine oil that does not conform to Audi oil specification VW 502 00.

Applies to vehicles with diesel engine only: Only if the level of the oil is at or below the minimum mark on the oil dipstick - and no oil that expressly conforms to Audi oil standard VW 507 00 specifications is available - may you top off with a high quality engine oil, that meets ACEA C3 or API CF specifications, but even then, only in viscosity grades SAE 5W-40, SAE 5W-30, or SAE 0W-40. However, during the entire time between oil change intervals, never top off with more than a total of 0.5 qt/liter engine oil that does not conform to Audi oil specification VW 507 00.

For more information about engine oil that has been approved for your vehicle, please contact either your authorized Audi dealer or Audi Customer Relations at 1 (800) 822-2834 or visit our web site at www.audiusa.com or www.audicanada.ca. Here you will also find a current list of oils (manufacturers, brand names etc.) that conform to Audi oil standard VW 502 00 (vehicles with gasoline engine) or VW 507 00 (vehicles with diesel engine).

Changing the engine oil

The engine oil and oil filter must be changed according to the mileage (kilometers) and time intervals specified in your vehicle’s Warranty & Maintenance booklet. Do not exceed these intervals – harmful deposits from old engine oil can reduce engine performance and can lead to expensive engine repairs.

Changing the oil at the recommended intervals is so very important because the lubricating properties of oil decrease gradually during normal vehicle use. If you are not sure when you have your oil changed, ask your authorized Audi Service Advisor. ▶

Under some circumstances the engine oil should even be changed more frequently. Change oil more often if you drive mostly short distances, operate the vehicle in dusty areas or mostly under stop-and-go traffic conditions, or when you use your vehicle where temperatures stay below freezing point for long periods.

Detergent additives in the oil will make fresh oil look dark after the engine has been running for a short time. This is normal and is not a reason to change the oil more often than recommended.

Damage or malfunctions due to lack of maintenance

It is essential that you change your oil at the recommended intervals using only engine oil that complies with Audi oil standard VW 502 00 (vehicles with gasoline engine) or VW 507 00 (vehicles with diesel engine). Your Limited New Vehicle Warranty does not cover damage or malfunctions due to failure to follow recommended maintenance and use requirements as set forth in the Audi Owner's Manual and Warranty & Maintenance booklet. Your dealer will have to deny warranty coverage unless you present to the dealer proof in the form of Service or Repair Orders that all scheduled maintenance was performed in a timely manner. ■

Engine oil consumption

The engine in your vehicle depends on an adequate amount of oil to lubricate and cool all of its moving parts.

In order to provide effective lubrication and cooling of internal engine components, all internal combustion engines consume a certain amount of oil. Oil consumption varies from engine to engine and may change significantly over the life of the engine. Typically, engines with a specified break-in period (see ⇒ *page 197*) consume more oil during the break-in period than they consume after oil consumption has stabilized.

Under normal conditions, the rate of oil consumption depends on the quality and viscosity of the oil, the RPM (revolutions per minute) at which the engine is operated, the ambient temperature and road conditions. Further factors are the amount of oil dilution from water

condensation or fuel residue and the oxidation level of the oil. As any engine is subject to wear as mileage builds up, the oil consumption may increase over time until replacement of worn components may become necessary.

With all these variables coming into play, no standard rate of oil consumption can be established or specified. There is no alternative to regular and frequent checking of the oil level, see **Note**.

If the yellow engine oil level warning symbol in the instrument cluster  lights up, you should check the oil level as soon as possible *with the oil dipstick* ⇒ *page 231*. Top off the oil at your earliest convenience ⇒ *page 232*.

WARNING

Before you check anything in the engine compartment, always read and heed all WARNINGS ⇒  in “Working in the engine compartment” on *page 226*.

Note

Driving with an insufficient oil level is likely to cause severe damage to the engine.

Tips

- The oil pressure warning display  is not an indicator of the oil level. Do not rely on it. Instead, check the oil level in your engine at regular intervals, preferably each time you refuel, and always before going on a long trip.
- If you have the impression your engine consumes excessive amounts of oil, we recommend that you consult your authorized Audi dealer to have the cause of your concern properly diagnosed. Keep in mind that the accurate measurement of oil consumption requires great care and may take some time. Your authorized Audi dealer has instructions about how to measure oil consumption accurately. ■

Checking the engine oil level

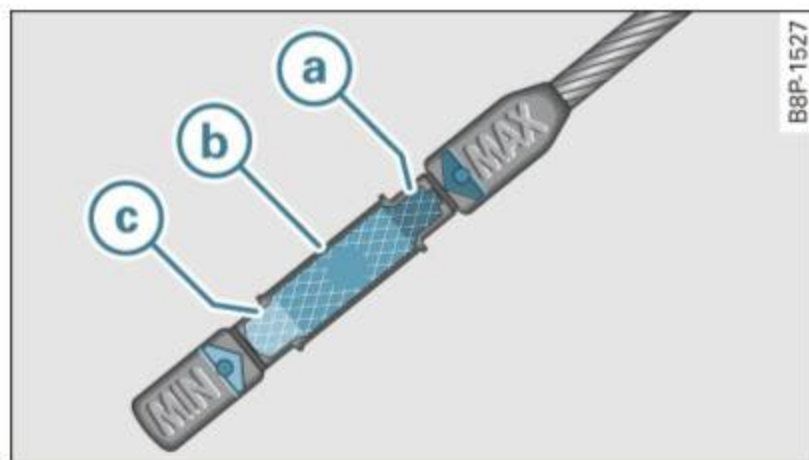

Fig. 163 Dipstick (Version A): Oil level ranges

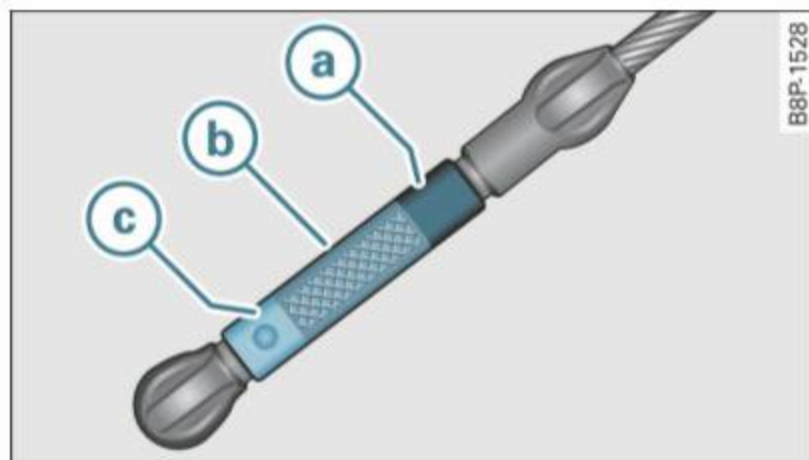

Fig. 164 Dipstick (Version B): Oil level ranges

Before you check anything in the engine compartment, **always read and heed all WARNINGS** ⇒ ⚠ in “Working in the engine compartment” on page 226.

Determining oil level

- Park your vehicle so that it is horizontally level.
- While at operating state temperature, briefly let the engine run at idle and then shut it off.
- Wait approx. two minutes.

- Pull out the oil dipstick. Wipe off the oil dipstick with a clean cloth, and slide it back in as far as it will go.
- Pull it back out and read off the oil level ⇒ fig. 163 or ⇒ fig. 164. Top off the engine oil, if applicable ⇒ page 232.

Oil level within range (a)

- Do *not* add oil.

Oil level within range (b)

- You *can* add oil. Afterwards, the oil level should be within range (a).

Oil level within range (c)

- You *must* add oil. Afterwards, the oil level should be within range (a).

The oil level needs to be checked at regular intervals. The best times to do this are whenever you refuel and prior to long trips.

Depending on the way the vehicle is driven and the operating conditions, oil consumption can be up to 1/2 quart per 600 miles (0.5 liter per 2,000 km). Consumption may be higher within the first 3,000 miles (5,000 km). ■

Adding engine oil



Fig. 165 Engine compartment: Oil filler cap location

Before you check anything in the engine compartment, **always read and heed all WARNINGS** ⇒  in “Working in the engine compartment” on *page 226*.

- Stopping the engine.
- Unscrew the cap  to the engine oil filling hole ⇒ fig. 165.
- Carefully top off with the appropriate oil in 0.5 liter doses.
- Check the oil level again after two minutes ⇒ *page 231*.
- Top off the oil again, if necessary.
- Screw the cap back on the filling hole and slide the oil dipstick in as far as it will go.

WARNING

- While topping off, the oil must not come in contact with hot engine parts - fire hazard!
- The oil filler cap must be properly secured to prevent oil from being sprayed on the hot engine and exhaust system when the engine is running - fire hazard!

WARNING (continued)

- If your skin has come in contact with the engine oil, you must subsequently cleanse it thoroughly.

Note

- The oil level must not be above range  - danger of converter or engine damage! Contact a qualified workshop to draw off oil, if necessary.
- Audi does not recommend the use of oil additives. They may damage the engine and adversely affect your New Vehicle Limited Warranty.

For the sake of the environment

- Under no circumstances can the oil come in contact with the sewage network or the soil.
- Observe and follow legal regulations when disposing of empty oil containers. ■

Changing the engine oil

We recommend that have your oil changed by an authorized Audi dealer or a qualified service station.

Before you check anything in the engine compartment, **always read and heed all WARNINGS** ⇒  in “Working in the engine compartment” on *page 226*.

The engine oil must be changed according to the intervals specified in your Warranty & Maintenance booklet. This is very important because the lubricating properties of oil diminish gradually during normal vehicle use.

Under some circumstances the engine oil should be changed more frequently. Change oil more often if you drive mostly short distances, operate the vehicle in dusty areas or under predominantly stop-and-

go traffic conditions, or have your vehicle where temperatures remain below freezing for extended periods. ►

Detergent additives in the oil will make fresh oil look dark after the engine has been running for a short time. This is normal and is not a reason to change the oil more often than recommended.

Because of the problem of proper disposal, along with the special tools and necessary expertise required, we strongly recommend that you have your oil changed by an authorized **Audi dealer** or a qualified service station.

If you choose to change your oil yourself, please note the following important information:

WARNING

To reduce the risk of personal injury if you must change the engine oil in your vehicle yourself:

- Wear eye protection.
- To reduce the risk of burns from hot engine oil, let the engine cool down to the touch.
- When removing the oil drain plug with your fingers, stay as far away as possible. Always keep your forearm parallel to the ground to help prevent hot oil from running down your arm.
- Drain the oil into a container designed for this purpose, one large enough to hold at least the total amount of oil in your engine.
- Engine oil is poisonous. Keep it well out of the reach of children.
- Continuous contact with used engine oil is harmful to your skin. Always protect your skin by washing oil off thoroughly with soap and water.

Note

Never mix oil additives with your engine oil. These additives can damage your engine and adversely affect your Audi New Vehicle Limited Warranty.

For the sake of the environment

- Before changing your oil, first make sure you know where you can properly dispose of the used oil.
- Always dispose of used engine oil properly. Do not dump it on garden soil, wooded areas, into open streams or down sewage drains.
- Recycle used engine oil by taking it to a used engine oil collection facility in your area, or contact a service station. ■

Applies to vehicles: with diesel engine

Important information for vehicles with diesel engine when adding or changing engine oil

On vehicles with a diesel engine always use engine oil that conforms to Audi oil specification VW 507 00 when adding or changing engine oil.

Vehicles with diesel engines require and **must always** use special engine oil that conforms to Audi oil specification **VW 507 00**.

Never use any other kind of engine oil in your vehicle, not even to top off the oil level.

At the time of printing, we are aware that Castrol® produces engine oil that conforms to Audi oil specification VW 507 00. This oil may not yet be available throughout North America. Other oil manufacturers may offer engine oil that conforms to Audi oil specification VW 507 00 at this time or some future date. ►

Please be sure to consult with your authorized Audi dealer for information and availability of the proper engine oil for your vehicle's diesel engine and for the latest technical information.

Because this special engine oil may not be available when need it, we strongly recommend that you always carry with you extra quart (liter) of oil that conforms to Audi oil specification VW 507 00, in case you have to top off oil while on the road.

WARNING

Failure to use engine oil for your diesel engine that expressly conforms to Audi oil specification VW 507 00 can cause engine failure on the highway that can cause a crash and serious personal injury.

- Never use any amount of engine oil in the diesel engine that does not conform to Audi oil specification VW 507 00.
- Always carry with you an extra quart (liter) of engine oil that conforms to Audi oil specification VW 507 00 in case you must top off the oil while on the road.

WARNING

Improperly stored items can become airborne missiles, flying through the vehicle causing serious personal injury in the event of hard braking or an accident. To help reduce the risk of serious personal injury:

- Always store extra quart (liter) of engine oil for your diesel engine in its original oil container that is securely closed in the luggage compartment. Make sure the container is securely stored and mounted.

Note

- If you use engine oil that does not expressly conform to Audi oil specification VW 507 00, very serious and very expensive damage to your vehicle's engine will occur. Engine damage caused by using the

wrong engine oil is not covered by your New Vehicle Limited Warranty.

- Not all commercially available oils conform to this very rigid Audi oil quality standard even though they may be synthetic-based and have the same viscosity. ■

Engine cooling system

Coolant

The engine coolant performs two functions: it keeps the engine from overheating and it protects the engine from freezing in the winter.

The cooling system is sealed and generally requires little attention.

The cooling system has been filled at the factory with a permanent coolant which does not need to be changed. The coolant consists of a mixture of water and the manufacturer's glycol-based coolant additive G12++ antifreeze with anticorrosion additives (50% for USA models; 60% for Canadian models). This mixture both assures the necessary frost protection and protects metal components in the engine's cooling system from corrosion and scaling. It also raises the boiling point of the coolant.

Do not reduce the concentration of the coolant in the summer by adding plain water. **The proportion of coolant additive must be at least 50% but not more than 60%** to maintain antifreeze protection and cooling efficiency. If the coolant frost protection is too low, the coolant could freeze and damage the vehicle heating and engine cooling system.

For year-round driving, antifreeze is added at the factory for temperatures down to:

- - 31 °F (- 35 °C) USA
- - 40 °F (- 40 °C) Canada.



You can mix the G12++ coolant additive with other additives G12+ or G12. Always check with your authorized Audi dealer.

WARNING

Before you check anything in the engine compartment, always read and heed all WARNINGS ⇒  in “Working in the engine compartment” on page 226.

Note

- Before winter sets in, have the coolant checked to see if the coolant additive in your vehicle is sufficient to meet the climate conditions. This is especially important if you live in a region where the winter is extremely cold. If necessary, increase the proportion of coolant additive to 60%.
- When adding coolant additive to your cooling system, remember:
 - We recommend using only coolant additive G12++ (check the label) for your vehicle. This coolant additive is available at authorized Audi dealers. Other types of antifreeze can significantly reduce corrosion protection. The resulting corrosion can cause a loss of coolant and serious engine damage.
- Do not add any type of radiator leak sealant to your vehicle's engine coolant. Adding radiator repair fluid may adversely affect the function and performance of your cooling system and could result in damage not covered by your New Vehicle Limited Warranty. ■

Checking the engine coolant level

The engine coolant level can be checked with a quick glance.

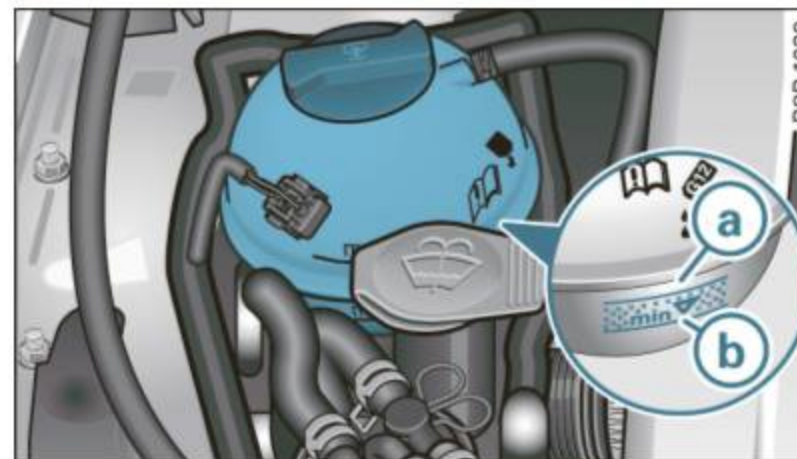



Fig. 166 Engine compartment: coolant expansion tank

Before you check anything in the engine compartment, **always read and heed all WARNINGS** ⇒  in “Working in the engine compartment” on page 226.

- Turn off the ignition.
- Read the engine coolant level from the coolant expansion tank ⇒ fig. 166. With a cold engine, the coolant level should be between the “min” and “max” markings. When the engine is warm, the level may be slightly above the “max” marking.

The location of the coolant expansion tank can be seen in the engine compartment illustration ⇒ page 227.

To obtain an accurate reading, the engine must be switched off.

The expansion tank in your vehicle is equipped with an electric coolant level sensor.

When the coolant level is too low, the warning light in the Auto-Check System ⇒ page 32 will blink until you add coolant and the level has been restored to normal. Even though there is an electric coolant

level sensor, we still recommend you check the coolant level from time to time.

Coolant loss

Coolant loss may indicate a **leak** in the cooling system. In the event of coolant loss, the cooling system should be inspected immediately by your authorized Audi dealer. It is not enough merely to add coolant.

In a **sealed** system, losses can occur only if the boiling point of the coolant is exceeded as a result of overheating.





Note

Do not add any type of radiator leak sealant to your vehicle's engine coolant. Adding radiator repair fluid may adversely affect the function and performance of your cooling system and could result in damage not covered by your New Vehicle Limited Warranty. ■

Adding coolant

Be very careful when adding engine coolant.

Before you check anything in the engine compartment, **always read and heed all WARNINGS** ⇒  in “Working in the engine compartment” on *page 226*.

- Turn off the engine.
- Let the engine cool down.
- Place a thick rag over the coolant expansion tank ⇒ *page 235*, fig. 166 and **carefully** twist the cap counter-clockwise ⇒ .
- Add coolant.
- Twist the cap on again *tightly*.

Replacement engine coolant must conform to exact specifications ⇒ *page 234*, “Coolant”. Even in an emergency, if coolant additive

G12++. G12+ or G12 is not available, do **not** use a different additive. Use plain water instead until you can get the correct additive and can restore the correct ratio. This should be done as soon as possible.

If you have lost a considerable amount of coolant, then you should add cold antifreeze and cold water only when the engine is cold.

Always use *new* engine coolant when refilling.

Do not fill coolant above the “MAX” mark. Excess coolant will be forced out through the pressure relief valve in the cap when the engine becomes hot.



WARNING

- **The cooling system is under pressure and can get very hot. Reduce the risk of scalding from hot coolant by following these steps.**
 - Turn off the engine and allow it to cool down.
 - Protect your face, hands and arms from escaping fluid and steam by covering the cap with a large, thick rag.
 - Turn the cap slowly and very carefully in a counter-clockwise direction while applying light, downward pressure on the top of the cap.
 - To avoid being burned, do not spill antifreeze or coolant on the exhaust system or hot engine parts. Under certain conditions, the ethylene glycol in engine coolant can catch fire.
- **Antifreeze is poisonous. Always store antifreeze in its original container and well out of the reach of children.**
- **If you drain the coolant, it must be caught and safely stored in a proper container clearly marked “poison”.**



Note

- Coolant pollutes the environment and could cause an engine fire. Excess coolant will be forced out through the pressure relief valve in the cap when the engine becomes hot. ►

- If, in an emergency, only water can be added, the correct ratio between water and antifreeze ⇒ *page 234* must be restored as soon as possible.



For the sake of the environment

Drained coolant should not be reused. Always dispose of used coolant while observing all environmental regulations. ■

Radiator fan

The radiator fan switches on automatically by itself.

The electric radiator fan is controlled by thermostats that switch on and off depending on coolant and engine compartment temperatures.

An auxiliary electric radiator fan* switches on and off depending on coolant temperature and other vehicle operation conditions.

After switching off the engine, the auxiliary fan - even with the ignition off - can continue running for up to 10 minutes. It can even switch on again later by itself ⇒ ⚠, if

- the temperature of the engine coolant rises due to the heat build-up from the engine in the engine compartment, or
- the engine compartment heats up because the vehicle is parked in intense sunlight.

⚠ WARNING

- **To reduce the risk of personal injury never touch the radiator fan.**
- **The auxiliary electric fan is temperature controlled and can switch on suddenly even when the engine is not running.**
- **The auxiliary radiator fan switches on automatically when the engine coolant reaches a certain temperature and will continue to run until the coolant temperature drops.** ■

Brake fluid

Checking brake fluid level

The brake fluid level can be checked with a quick glance.

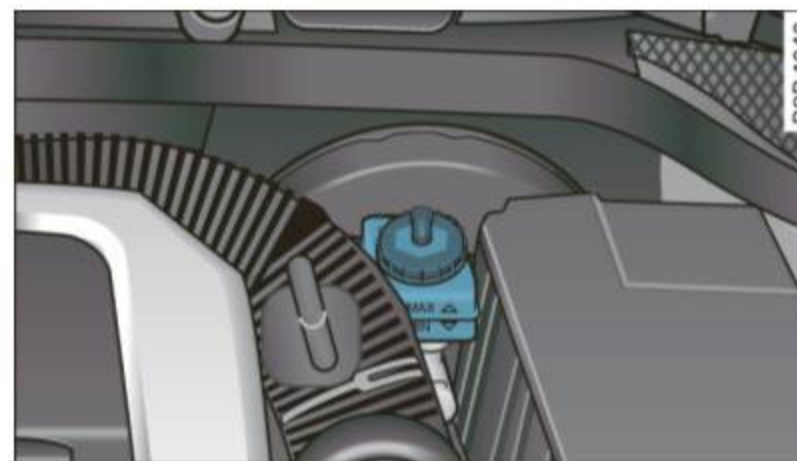

Fig. 167 Engine compartment: brake fluid reservoir

Before you check anything in the engine compartment, **always read and heed all WARNINGS** ⇒ ⚠ in “Working in the engine compartment” on *page 226*.

- Read the brake fluid level from the brake fluid reservoir. The brake fluid level must be between the “MIN” and “MAX” markings ⇒ *fig. 167*.

The brake fluid reservoir is located at the rear partition of the engine compartment on the left side ⇒ *page 227*.

The fluid level may drop *slightly* after some time due to the automatic adjustment of the brake pads. This is not cause for alarm.

If the brake fluid level falls *considerably* below the “MIN” mark, the brake warning/indicator light (U.S. models: **BRAKE**, Canadian models: Ⓢ) will come on ⇒ *page 15* and ⇒ *page 32*. Do not continue to operate the vehicle. The complete brake system should be thoroughly checked by an authorized Audi dealer or other qualified facility and the cause corrected. If the brake fluid level is too low, the brake

warning/indicator light will illuminate. Contact an authorized Audi dealer **immediately**. ■

Changing brake fluid

Have the brake fluid changed by an experienced technician.

Brake fluid absorbs moisture from the air. If the water content in the brake fluid is too high, corrosion in the brake system may result after a period of time. The boiling point of the brake fluid will also decrease considerably and decrease braking performance.

Therefore, the brake fluid must be changed **every two years**. Always use new brake fluid which conforms to Federal Motor Vehicle Standard "FMVSS 116 DOT 4".

The brake fluid reservoir can be difficult to reach, therefore, we recommend that you have the brake fluid changed by your authorized **Audi dealer**. Your dealer has the correct tools, the right brake fluid and the know-how to do this for you.

WARNING

- Brake fluid is poisonous. It must be stored only in the closed original container out of the reach of children!
- Brake failure can result from old or inappropriate brake fluid. Observe these precautions:
 - Use only brake fluid that meets SAE specification J 1703 and conforms to Federal Motor Vehicle Standard 116. Always check with your authorized Audi dealer to make sure you are using the correct brake fluid. The correct type of brake fluid is also indicated on the brake fluid reservoir.
 - The brake fluid must be new. Heavy use of the brakes can cause a vapor lock if the brake fluid is left in the system too long. This can seriously affect the efficiency of the brakes as well as your safety. This could result in an accident.

Note

Brake fluid will damage the paint of your vehicle.

For the sake of the environment

Because of the problem of proper disposal of brake fluid as well as the special tools required and the necessary expertise, we recommend that you have the brake fluid changed by your authorized Audi dealer. ■

Battery

General information

All work on the battery requires technical knowledge!

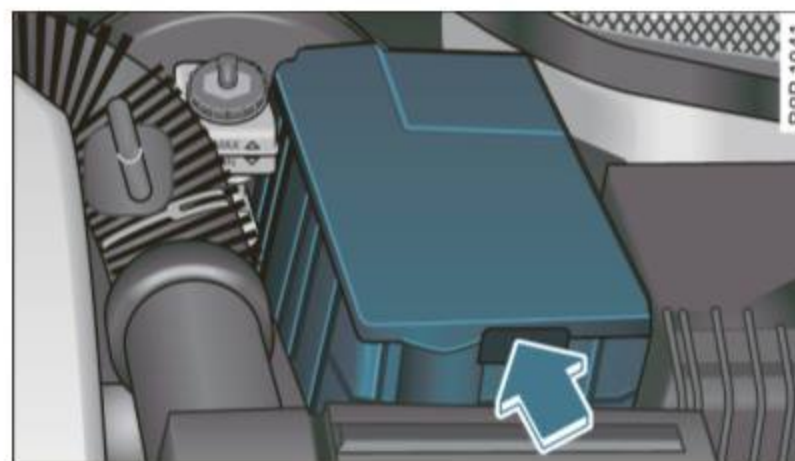

Fig. 168 Engine compartment: Battery with cover*

The battery is located in the engine compartment ⇒ fig. 168 and is nearly **maintenance-free**.

The condition of the battery is checked in the framework of the inspection.

Disconnecting the battery

The battery should not be disconnected. Some vehicle functions such as power windows are unavailable if the battery terminals are discon- ▶

nected. These functions have to be relearned after the battery terminals are connected again. To prevent this, the battery should only be disconnected from the vehicle electrical system if absolutely necessary.

Function	Reprogramming
Power window one-touch up/down function	⇒ <i>page 51</i> , “Reactivating the system after battery disconnection”
Master key with remote control	Synchronization ⇒ <i>page 43</i>
Digital clock	⇒ <i>page 9</i>
ESP indicator light	The indicator light goes out after driving a few meters

Vehicles not driven for long periods and short-distance operation

If you do not drive your vehicle for several days or weeks, electrical consumers are gradually scaled back or switched off. This reduces energy use and ensures the vehicle will be able to start after long periods of time ⇒ *page 194*. Some convenience functions such as opening with the remote control key may not be available. These convenience functions will be available again once you switch the ignition on and start the engine. Even when consumers are switched off, the battery will become deeply discharged by stand-by power consumers if the vehicle is not driven for several months. Deep discharging results in a chemical reaction that destroys the inside of the battery. The battery must be charged every month to prevent this ⇒ *page 241*. Do not disconnect the battery or the anti-theft alarm system* will not work.

Winter operation

Cold weather places higher demands on the battery. This results in reduced starting ability. Have the battery checked and recharged if necessary before the cold weather begins.

Avoid unnecessary power consumption, particularly in city traffic or when traveling only short distances. Let your authorized Audi dealer

check the capacity of the vehicle battery before winter sets in ⇒ *page 241*. A well charged battery will not only prevent starting problems when the weather is cold, but will also last longer.

Note

- All work on the battery requires technical knowledge. Please contact an Audi dealership or another authorized facility for questions about the battery - danger of acid burns and explosion hazard!
- The battery must not be opened! Do not try to change the battery's liquid level, otherwise detonating gas will escape from the battery - explosion hazard!
- The AGM battery in the luggage compartment cannot leak, because the electrolyte for this battery is absorbed into a special glass mat. This leak-proof battery must not be replaced with a conventional battery.
- Make sure the ventilation hose on the side of the battery is connected, otherwise fumes or battery acid can leak out.
- Battery holder and terminals always have to be secured correctly.
- Before all work on the battery follow the **warnings** below ⇒  in “Working on the battery” on *page 239*. ■

Working on the battery





All work on the battery requires technical knowledge! Be especially careful when working on or near the battery!

Before you check anything in the engine compartment, always **read and heed all WARNINGS** ⇒  in “Working in the engine compartment” on *page 226*.

Always heed the **safety warnings**, when working on the vehicle battery or the vehicle electrical system to prevent injury. ▶

The following WARNINGS are very important when working on the battery:

Always heed the following WARNING SYMBOLS and safety precautions when working on the battery.

	Always wear eye protection.
	Battery acid contains sulfuric acid. Always wear gloves and eye protection.
	No - sparks - flames - smoking.
	When a battery is charged, it produces hydrogen gas which is explosive and could cause personal injury.
	Always keep the battery well out of reach of children.

WARNING

Whenever working on the battery or on the electrical system, there is the risk of injury, accident and even fire. Read and heed the following WARNINGS:

- Always wear eye protection. Do not let battery acid or any lead particles get on your skin or clothing. Shield your eyes. Explosive gases can cause blindness or other injury!
- Battery acid contains sulfuric acid. Sulfuric acid can cause blindness and severe burns.
 - Always wear gloves and eye protection. Do not tilt the battery because acid could leak out of the ventilation openings.

WARNING (continued)

- If you get battery acid in your eyes or on your skin, immediately rinse with cold water for several minutes and get medical attention.
- If you should ingest any battery acid, seek medical attention immediately.
- Do not expose the battery to an open flame, electric sparks or an open light.
- Do not smoke.
- Do not interchange the positive and negative cables.
- When working on the battery, be sure not to short-circuit the terminals with tools or other metal objects. This would cause the battery to heat up very quickly, which could lead to damage or explosion and personal injury.
- When a battery is charged, it produces hydrogen gas which is explosive and could cause personal injury.
- Always keep the battery well out of the reach of children.
- Before work is done on the electrical system, disconnect the negative ground cable.
- Before performing any work on the electrical system, switch off the engine and ignition as well as any electrical equipment. The negative cable on the battery must be disconnected. If you are just going to replace a light bulb, then it is enough to switch off the lights.
- Before disconnecting the battery, switch off the anti-theft alarm system! Otherwise you will set off the alarm.
- When disconnecting the battery, first disconnect the negative cable and then the positive cable.
- Before reconnecting the battery, make sure all electrical consumers are switched off. Reconnect the positive cable first and then the negative cable. Never interchange the cables - this could start a fire!

⚠ WARNING (continued)

- Never charge a frozen or a thawed-out battery. It could explode! If a battery has frozen, then it must be replaced. A discharged battery can freeze over at 32 °F (0 °C).
- Make sure the vent hose is always attached to the opening on the side of the battery.
- Never use batteries which are damaged. There is the danger of an explosion! Always replace a damaged battery.

⚠ WARNING

California Proposition 65 Warning:

- Battery posts, terminals and related accessories contain lead and lead compounds, chemicals known to the State of California to cause cancer and reproductive problems. Wash hands after handling.

! Note

- Do not disconnect the vehicle battery when the ignition is switched on or when the engine is running, otherwise, you will damage electronic components in the electrical system.
- When working on the engine, protect the battery housing from ultraviolet (UV) rays by not parking the vehicle in direct sunlight.
- If your vehicle is going to stand for a long period of time without being driven, protect the battery from “freezing”, otherwise it will be damaged and will then have to be replaced ⇒ *page 241*. ■

Charging of battery

All work on the battery requires technical knowledge!

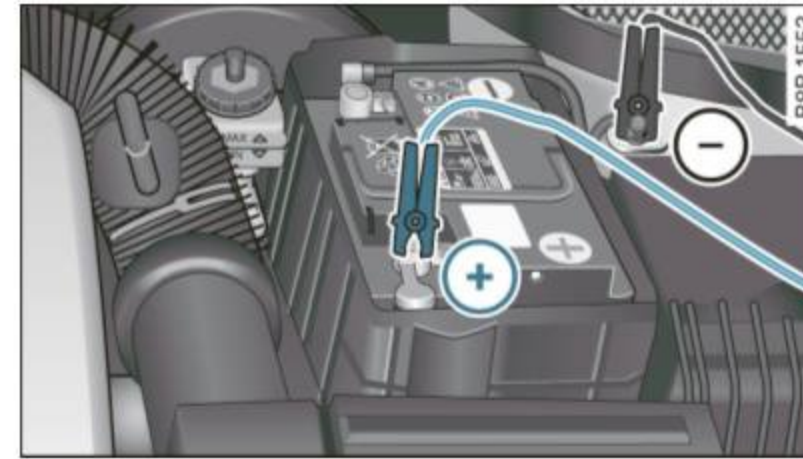



Fig. 169 Engine compartment: connectors for a charger and jump start cables

A charged battery ensures good starting performance. A discharged battery can **freeze** at temperatures of only 0 °C. A frozen or thawed battery must be replaced, as the battery housing may be cracked due to freezing and could therefore leak acid.

- **Always read and heed all WARNINGS** below ⇒ **⚠** and ⇒ **⚠** in “Working on the battery” on *page 239*.
- Switch off the ignition and all electrical consumers.
- Make sure the area is well ventilated when you charge the battery.
- Connect charger cables. **Charger cables must always be connected POSITIVE (+) to POSITIVE (+) and NEGATIVE (-) to NEGATIVE (jump start pins) (-).**
- Switch on the charger.
- Make sure the charging rate is not over 6 amps.
- Turn off the charger ⇒ **⚠**.
- Disconnect the charger cables.

- Connect both battery cables to the battery if necessary - *first plus, then minus.*

The battery must not be opened! ⇒  in “General information” on page 238.

Charging the battery

Only use chargers with a **maximum charging voltage of 14.8 V**. The battery connecting cables do not need to be disconnected. Do not open the battery when charging.

Read all of the manufacturer's instructions for the charger before charging the battery.

It is not necessary to remove the battery from the engine compartment, and it is also not necessary to disconnect the cables.

Normally, a battery should be charged at no more than 10 percent of its rated capacity.

For example, a charging current of 4.5 amps would be used on a battery rated at 45 Ah. Rated capacity of the battery in your vehicle is listed on the battery housing.

The battery caps should *not* be opened when charging a battery.

WARNING

Charging a battery can be dangerous.

- **Never charge a frozen battery. It may explode because of gas trapped in the ice. Allow a frozen battery to thaw out first.**
- **Do not reuse batteries which were frozen. They must be replaced. The battery housing may have cracked and weakened when the battery froze.**
- **Charge the battery in a well ventilated area. Keep away from open flame or electrical spark. Do not smoke. Hydrogen gas generated by the battery is explosive.**
- **To reduce the danger of explosion, never connect or disconnect charger cables while the charger is operating.**

WARNING (continued)

- **Fast charging a battery is dangerous and should only be attempted by a competent technician with the proper equipment.**
- **Battery acid that may spill during charging should be washed off with a solution of warm water and baking soda to neutralize the acid.**

Note

- Make sure that the gas venting hose is always connected to the original opening on the battery side. Otherwise gasses or battery acid could leak out.
- Never use a fast charger as a booster to start the engine. This will seriously damage sensitive electronic components, such as control units, relays, radio, etc., as well as the battery charger.
- The vehicle may be optionally equipped with a gel battery, which can only be charged at a constant current-limited voltage. To prevent damage to the battery and the electronics system, a gel battery that is connected must under no circumstances be charged with a quick charger.

Tips

- The vehicle battery must not be charged with a standard small charger that plugs into the outlet.
- Only charge the battery through the connections in the engine compartment. ■

Battery replacement

The new battery must have the same specifications as the old one.

Intelligent energy management in your vehicle is responsible for distributing the electrical energy throughout your vehicle

⇒ *page 194*. The intelligent energy management system will keep the engine battery charged better than vehicles without this system. To make sure the additional electrical energy is available once again after you have changed the battery, we recommend that you install batteries of the same type and manufacture only (the same as those installed at the time your vehicle was delivered). Specifications are listed on the battery housing. Your authorized dealer must code the battery in the energy management system to enable you to use the energy management functions correctly after replacing the battery.

If it is not possible to use a battery of this type, the new battery must have the same capacity, voltage (12 volts), amperage, construction and plug sealing.

We recommend that you use maintenance-free or **cycle-resistant/leak-proof** batteries that conform to the standards TL 825 06 (from December 1997) and VW 7 50 73 (from August 2001).

When installing the battery, make sure the ignition and all electrical consumers are turned off.

! Note

- Make sure that the gas venting hose is always connected to the original opening on the battery side. Otherwise gasses or battery acid could leak out.
- Battery mounts and clamps must always be secured correctly.
- Read and follow the warnings under ⇒ *page 239*, “Working on the battery” before performing any work on the battery.

🌸 For the sake of the environment

Because of the problem of proper disposal of a battery, we recommend your authorized Audi dealer change the battery for you. Batteries contain sulfuric acid and lead and must always be disposed of properly in compliance with all environmental regulations. Disposing of vehicle batteries improperly is very dangerous to the environment. Make sure that the removed battery cannot overbalance, otherwise sulfuric acid might escape! ■

Windshield washer container

Using plain water is not adequate for filling the windshield washer system.

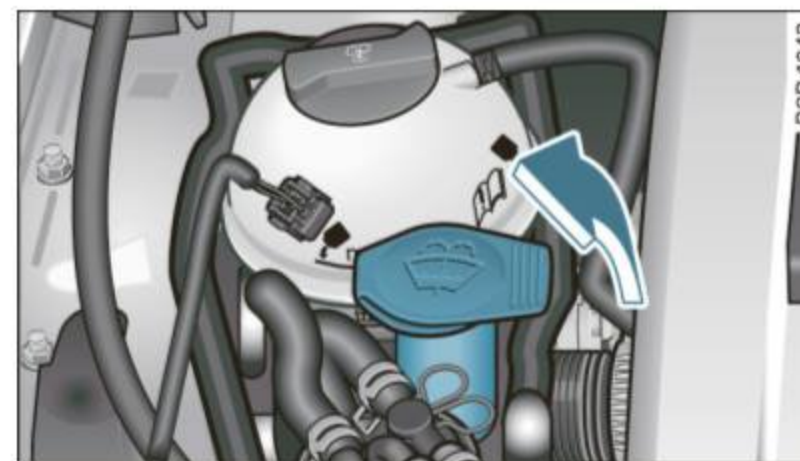

Fig. 170 Engine compartment: windshield washer fluid container

The windshield washer fluid container is located on the right side of the engine compartment ⇒ *fig. 170*. The washer fluid container is marked with the symbol 🚿 is on its cap.

- Before you check anything in the engine compartment, always **read and heed all WARNINGS** ⇒ ⚠ in “Working in the engine compartment” on *page 226*.
- Lift the filler cap tongue to add washer fluid. You can fill the container to the top.
- Press the cap back onto the filler neck after filling the container.

You can find the reservoir **capacity** in the table in ⇒ *page 296*.

Clean water should be used when filling up. If possible, use soft water to prevent scaling on the washer jets. Always add a glass cleaner solution (with frost protection in the winter). ▶

**Note**

Do not mix engine coolant antifreeze or any other additives to fill up the windshield washer reservoir. ■

Tires and wheels

Tires

General notes

Tires may be the least appreciated and most abused parts of a motor vehicle.

Tires may be the least appreciated and most abused parts of a motor vehicle. Tires are, however, one of the most important parts of a vehicle, particularly considering the comparatively small patch of rubber on each tire that assures that all-important contact between you, your vehicle and the road.

Maintaining the correct tire pressure, making sure that your vehicle and its tires do not have to carry more weight than they can safely handle, avoiding damage from road hazards and regularly inspecting tires for damage including cuts, slashes irregular wear and overall condition are the most important things that you can do to help avoid sudden tire failure including tread separation and blowouts.

Avoiding damage

If you have to drive over a curb or similar obstacle, drive very slowly and as close as possible at a right angle to the curb.

Always keep chemicals including grease, oil, gasoline and brake fluid off the tires.

Inspect the tires regularly for damage (cuts, cracks or blisters, etc.). Remove any foreign bodies embedded in the treads.

Storing tires

Mark tires when you remove them to indicate the direction of rotation. This ensures you to be able to mount them correctly when you reinstall them.

When removed, the wheels or tires should be stored in a cool, dry and preferably dark place.

Store tires in a vertical position if they are not mounted on rims, in a horizontal position if they are mounted on rims.

New tires

New tires have to be broken in ⇒ .

The tread depth of new tires may vary, according to the type and make of tire and the tread pattern.

Hidden damage

Damage to tires and rims is often not readily visible. If you notice unusual vibration or the vehicle pulls to one side, this may indicate that one of the tires has been damaged. The tires must be checked immediately by an authorized Audi dealer or qualified workshop.

Unidirectional tires

A unidirectional tire can be identified by arrows on the sidewall, that point in the direction the tire is designed to rotate. You must follow the specified direction of rotation. This is necessary so that these tires can develop their optimum characteristics regarding grip, road noise, wear and hydroplaning resistance. For more information ⇒ page 279.

WARNING

New tires or tires that are old, worn or damaged cannot provide maximum control and braking ability.

- **New tires tend to be slippery and must be broken in. To reduce the risk of losing control, a collision and serious personal injuries, drive with special care for the first 350 miles (560 km).**
- **Driving with worn or damaged tires can lead to loss of control, sudden tire failure, including a blowout and sudden deflation, crashes and serious personal injuries. Have worn or damaged tires replaced immediately.**

⚠ WARNING (continued)

- Tires age even if they are not being used and can fail suddenly, especially at high speeds. Tires that are more than 6 years old can only be used in an emergency and then with special care and at low speed.

⚠ WARNING (continued)

- Never mount used tires on your vehicle if you are not sure of their “previous history.” Old used tires may have been damaged even though the damage cannot be seen that can lead to sudden tire failure and loss of vehicle control.
- If you notice unusual vibration or if the vehicle pulls to one side when driving, always stop as soon as it is safe to do so and check the wheels and tires for damage. ■

Glossary of tire and loading terminology

Accessory weight

means the combined weight (in excess of those standard items which may be replaced) of automatic transmission, power steering, power brakes, power windows, power seats, radio, and heater, to the extent that these items are available as factory-installed equipment (whether installed or not).

Aspect ratio

means the ratio of the height to the width of the tire in percent. Numbers of 55 or lower indicate a low sidewall for improved steering response and better overall handling on dry pavement.

Bead

means the part of the tire that is made of steel wires, wrapped or reinforced by ply cords and that is shaped to fit the rim.

Bead separation

means a breakdown of the bond between components in the bead.

Cord

means the strands forming the plies in the tire.

Cold tire inflation pressure

means the tire pressure recommended by the vehicle manufacturer for a tire of a designated size that has not been driven for more than a couple of miles (kilometers) at low speeds in the three hour period before the tire pressure is measured or adjusted.

Curb weight

means the weight of a motor vehicle with standard equipment including the maximum capacity of fuel, oil, and coolant, air conditioning and additional weight of optional equipment.

Extra load tire

means a tire designed to operate at higher loads and at higher inflation pressures than the corresponding standard tire. Extra load tires may be identified as “XL”, “xl”, “EXTRA LOAD”, or “RF” on the sidewall.

Gross Axle Weight Rating (“GAWR”)

means the load-carrying capacity of a single axle system, measured at the tire-ground interfaces.

Gross Vehicle Weight Rating (“GVWR”)

means the maximum total loaded weight of the vehicle. ►

Groove

means the space between two adjacent tread ribs.

Load rating (code)

means the maximum load that a tire is rated to carry for a given inflation pressure. You may not find this information on all tires because it is not required by law.

Maximum load rating

means the load rating for a tire at the maximum permissible inflation pressure for that tire.

Maximum loaded vehicle weight

means the sum of:

- (a) Curb weight
- (b) Accessory weight
- (c) Vehicle capacity weight, and
- (d) Production options weight

Maximum (permissible) inflation pressure

means the maximum cold inflation pressure to which a tire may be inflated. Also called “maximum inflation pressure.”

Normal occupant weight

means 150 lbs. (68 kilograms) times the number of occupants seated in the vehicle up to the total seating capacity of your vehicle.

Occupant distribution

means distribution of occupants in a vehicle.

Outer diameter

means the overall diameter of an inflated new tire.

Overall width

means the linear distance between the exteriors of the sidewalls of an inflated tire, including elevations due to labeling, decorations, or protective bands or ribs.

Ply

means a layer of rubber-coated parallel cords.

Production options weight

means the combined weight of those installed regular production options weighing over 5 lbs. (2.3 kg) in excess of those standard items which they replace, not previously considered in curb weight or accessory weight, including heavy duty brakes, ride levelers, roof rack, heavy duty battery, and special trim.

Radial ply tire

means a pneumatic tire in which the ply cords that extend to the beads are laid at substantially 90 degrees to the centerline of the tread.

Recommended inflation pressure

see ⇒ page 246, “Cold tire inflation pressure”.

Reinforced tire

means a tire designed to operate at higher loads and at higher inflation pressures than the corresponding standard tire. Reinforced tires may be identified as “XL”, “xl”, “EXTRA LOAD”, or “RF” on the sidewall.

Rim

means a metal support for a tire or a tire and tube assembly upon which the tire beads are seated.

Rim diameter

means nominal diameter of the bead seat. If you change your wheel size, you will have to purchase new tires to match the new rim diameter.

Rim size designation

means rim diameter and width.

Rim width

means nominal distance between rim flanges.

Sidewall

means that portion of a tire between the tread and bead.

Speed rating (letter code)

means the speed at which a tire is designed to be driven for extended periods of time. The ratings range from 93 mph (150 km/h) to 186 mph (298 km/h) ⇒ *page 259*. You may not find this information on all tires because it is not required by law.

The speed rating letter code, where applicable, is molded on the tire sidewall and indicates the maximum permissible road speeds. ⇒ ⚠ in “Winter tires” on *page 261*

Tire pressure monitoring system*

means a system that detects when one or more of a vehicle's tires are underinflated and illuminates a low tire pressure warning telltale.

Tread

means that portion of a tire that comes into contact with the road.

Tread separation

means pulling away of the tread from the tire carcass.

Treadwear indicators (TWI)

means the projections within the principal grooves designed to give a visual indication of the degrees of wear of the tread. See ⇒ *page 256*, “Tread Wear Indicator (TWI)” for more information on measuring tire wear.

Uniform Tire Quality Grading

is a tire information system developed by the United States National Highway Traffic Safety Administration (NHTSA) that is designed to help buyers make relative comparisons among tires. The UTQG is not a safety rating and not a guarantee that a tire will last for a prescribed number of miles or perform in a certain way. It simply gives tire buyers additional information to combine with other considerations, such as price, brand loyalty and dealer recommendations. Under UTQG, tires are graded by the tire manufacturers in three areas:

treadwear, traction and temperature resistance. The UTQG information on the tires, molded into the sidewalls.

U.S. DOT Tire Identification Number (TIN)

This is the tire's “serial number” It begins with the letters “DOT” and indicates that the tire meets all federal standards. The next two numbers or letters indicate the plant where it was manufactured, and the last four numbers represent the week and year of manufacture. For example,

DOT ... 2209 ...

means that the tire was produced in the 22nd week of 2009. The other numbers are marketing codes that may or may not be used by the tire manufacturer. This information is used to contact consumers if a tire defect requires a recall.

Vehicle capacity weight

means the rated cargo and luggage load plus 150 lbs. (68 kilograms) times the vehicle's total seating capacity as listed on the label located either on the driver's side B-pillar or on the inside of the fuel filler flap.

Vehicle maximum load on the tire

means that load on an individual tire that is determined by distributing to each axle its share of the maximum loaded vehicle weight and dividing by two.

Vehicle normal load on the tire

means that load on an individual tire that is determined by distributing to each axle its share of the curb weight, accessory weight, and normal occupant weight (distributed in accordance with table below ⇒ *page 249*) and dividing by two. ▶

Occupant loading and distribution for vehicle normal load for various designated seating capacities

Designated seating capacity, number of occupants	Vehicle normal load, number of occupants	Occupant distribution in a normally loaded vehicle
5	3	2 in front, 1 in back seat

Cold tire inflation pressure

Tire pressure affects the overall handling, performance and safety of a vehicle.



Fig. 171 Tire pressure label: located either on driver's side B-pillar or inside the fuel filler flap

Tire pressure generally refers to the amount of air in a tire that it needs it to do its job and safely carry the combined load of the entire vehicle and its contents. Tire pressure is measured in kilopascals (kPa), the international measuring unit and in pounds per square inch (PSI). Tire pressure is based in part on the vehicle's design and load limit – the greatest amount of weight that the vehicle can carry safely and the tire size. The proper tire pressure is frequently referred to as the “recommended cold tire inflation pressure.” Air in the tires expands when the tire heats up because of internal friction when it flexes in use. The tire pressure is higher when the tire has warmed up than when it is “cold.” It is the inflation pressure in a “cold” tire that counts. Therefore, you should never let air out of a warm tire to match “cold tire inflation pressure” recommendations. The tires would then be underinflated and could fail suddenly.

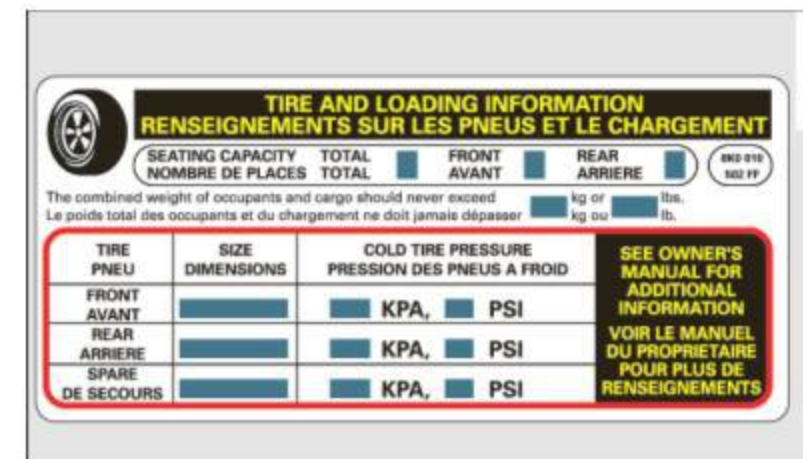

Fig. 172 Tire pressure label

Maintaining proper tire pressure is one of the most important things you can do to help avoid sudden tire failure. Underinflated tires are a major cause of sudden tire failure. Keeping tires at the right pressure is also important for safe and responsive vehicle handling, traction, braking and load carrying. **Tire pressures are particularly important when the vehicle is being driven at higher speeds, and then especially when heavily loaded even within the permissible load-carrying capacities approved for your vehicle.**

The recommended tire pressures for your Audi depend on the kind of tires on your vehicle and the number of passengers and/or amount of luggage you will be transporting.

On USA vehicles, the tire pressure label is located on driver's side B-pillar. On Canada vehicles, the tire pressure label is located either on the driver's side B-pillar or inside the fuel filler flap. The tire pressure label lists the recommended cold tire inflation pressures for the

vehicle at its maximum capacity weight and tires that were on your vehicle at the time it was manufactured.

If you wish to improve comfort when operating the vehicle at normal load (up to 3 occupants), you can adjust tire pressures to those specified for normal vehicle load. Before operating the vehicle at maximum load, you must increase the tire pressures to those specified for maximum vehicle load ⇒ ⚠.

Bear in mind that the tire pressure monitoring system* can only monitor the tire pressures you have stored. The system does not recognize the load condition of your vehicle.

The effectiveness of the tire pressure monitoring system* will be impaired if you store normal load pressures but then operate the vehicle at its maximum load ⇒ ⚠.

See the illustration ⇒ *page 249*, fig. 171 for the location of the label either on driver's side B-pillar or inside the fuel filler flap (color of the actual label and exact location on the vehicle will vary slightly).

Note that the following table is accurate at the time of going to press and is subject to change. In the event of discrepancies, the tire pressure label (on USA vehicles, the tire pressure label is located on driver's side B-pillar; on Canada vehicles, the tire pressure label is located either on the driver's side B-pillar or inside the fuel filler flap.) always takes precedence.

The table below lists the recommended cold tire inflation pressures for the Audi model covered by your Owner's Literature at the vehicle's capacity weight and the tire sizes installed on the respective models as original equipment, or as a factory option.

Engine (displacement in liter)	Tire designation	Tire pressure front				Tire pressure rear			
		normal load condition (up to 3 occupants)		full load condition		normal load condition (up to 3 occupants)		full load condition	
		PSI	kPA	PSI	kPA	PSI	kPA	PSI	kPA
4-cylinder 2.0 TFSI (gasoline)	205/55 R16 91H All Season	36	250	39	270	30	210	38	260
	225/45 R17 91W High Performance	35	240	38	260	30	210	36	250
	225/45 R17 94H XL All Season	38	260	39	270	32	220	38	260
	225/45 R17 94Y XL High Performance	35	240	36	250	30	210	35	240
	225/40 R18 92Y XL High Performance	38	260	41	280	35	240	41	280
	Compact spare wheel T125/70 R18	60	420	60	420	60	420	60	420

Engine (displacement in liter)	Tire designation	Tire pressure front				Tire pressure rear			
		normal load condition (up to 3 occupants)		full load condition		normal load condition (up to 3 occupants)		full load condition	
		PSI	kPA	PSI	kPA	PSI	kPA	PSI	kPA
4-cylinder 2.0 TDI (clean diesel)	205/55 R16 91H All Season	36	250	39	270	30	210	36	250
	225/45 R17 94H XL All Season	38	260	41	280	32	220	38	260
	225/45 R17 94Y XL High Performance	35	240	38	260	30	210	35	240
	225/40 R18 92Y XL High Performance	35	240	38	260	30	210	38	260
	Compact spare wheel T125/70 R18	60	420	60	420	60	420	60	420

XL = reinforced or extra load tire. It may also appear as **xl**, **EXTRA LOAD**, or **RF** on the tire sidewall. ▶

The correct tire pressure for the *spare wheel* is located on a label either on the driver's side B-pillar or inside the fuel filler flap.

Because technical changes may be made to vehicle equipment during the model year, always compare the tire size designation on the tire pressure label on your vehicle with the tires on your vehicle. Make sure that the tire size information on the vehicle label is the same as the size of the tires on the vehicle. This is especially important if the vehicle belongs to someone else or you bought the vehicle with different rims/tires or you bought the vehicle as a previously owned vehicle.

Remember, your safety and that of your passengers also depends on making sure that load limits are not exceeded. Vehicle load includes everybody and everything in and on the vehicle. These load limits are technically referred to as the vehicle's Gross Vehicle Weight Rating ("GVWR"). The Gross Axle Weight Rating ("GAWR") is the maximum load that can be applied at each of the vehicle's two axles. The Gross Vehicle Weight Rating and the Gross Axle Weight Rating are listed on the safety compliance sticker label located either on the driver's side B-pillar or on the inside of the fuel filler flap. The tire pressure label on your Audi lists the maximum combined weight of all of the occu-

pants and luggage or other cargo that the vehicle can carry. For the location of the tire pressure label ⇒ *page 249*, fig. 171.

WARNING

Overloading a vehicle can cause loss of vehicle control, a crash or other accident, serious personal injury, and even death.

- Carrying more weight than your vehicle was designed to carry will prevent the vehicle from handling properly and increase the risk of a loss of vehicle control.
- The brakes on a vehicle that has been overloaded may not be able to stop the vehicle within a safe distance.
- Tires on a vehicle that has been overloaded can fail suddenly causing loss of control and a crash.
- Always make sure that the total load being transported – including the weight of a trailer hitch and the tongue weight of a loaded trailer – does not make the vehicle heavier than the vehicle's Gross Vehicle Weight Rating. ▶

 **WARNING**

- **Incorrect tire pressures and/or underinflation can lead to a serious or fatal accident.**
- **Incorrect tire pressures and/or underinflation cause increased tire wear and can affect the handling of the vehicle.**
- **Incorrect tire pressures and/or underinflation can also lead to sudden tire failure, including a blowout and sudden deflation, causing loss of vehicle control. ■**

Checking tire pressure

The correct tire pressure for the tires originally installed on your vehicle is listed on the tire pressure label located either on driver's side B-pillar or inside the fuel filler flap.

The recommended tire pressures are on the tire pressure label and in the table ⇒ *page 249*, “Cold tire inflation pressure”. This means that the pressure must be checked and adjusted when the tire has not been driven for more than a couple of miles (kilometers) at low speeds during the previous three hours. Air in the tires expands when the tire heats up as a result of internal friction as it flexes in use. The tire pressure is higher when the tire has warmed up than when it is “cold.”

It is the inflation pressure in a “cold” tire that counts. Therefore, you should never let air out of a warm tire to match “Cold tire inflation pressure” recommendations ⇒ *page 249*. The tires would then be underinflated and could fail suddenly.

The tire pressure label on your Audi lists the recommended cold tire inflation pressures for the new, original equipment tires that were on your vehicle at the time it was manufactured. For the location of the label ⇒ *page 249*, fig. 171.

Most tires lose air naturally over time. They can also lose some air if you drive over a pothole or hit a curb while parking. It is usually not

possible to see whether the radial tires used today are underinflated just by looking at them.

Therefore, be sure to check tire pressures at least once a month and always before going on a long trip. Make sure to take the number of people and the amount of luggage into account when adjusting tire pressure for a trip – even one that you would not consider to be “long.” See ⇒ *page 253*, “Tires and vehicle load limits” for more important information.

Always use an accurate tire pressure gauge when checking and adjusting inflation pressures. Check all of the tires and be sure not to forget the spare tire. If the pressure in any tire is too high when the tire is “cold,” let air out of the tire slowly with the edge of the tire gauge and keep checking the pressure until you reach the pressure that is correct for the load (passengers and luggage) and kind of driving you plan to do.

If the pressure in any tire is too low, note the difference between the pressure in the cold tire and the pressure you need and add the air that you need to reach the correct pressure for the vehicle load (passengers and luggage) for the tires on your vehicle as listed on the on your vehicle and in this manual and the kind of driving you plan to do.

Never exceed the maximum inflation pressure listed on the tire sidewall for any reason.

Remember that the vehicle manufacturer, not the tire manufacturer, determines the correct tire pressure for the tires on your vehicle.

It is important to check the tire pressure when the tires are cold.

- Read the required tire pressure from the tire pressure label. On USA vehicles, the tire pressure label is located on driver's side B-pillar. On Canada vehicles, the tire pressure label is located either on the driver's side B-pillar or inside the fuel filler flap.
- Turn the valve stem cap counter-clockwise to remove it from the tire valve.
- Place the air pressure gauge on the valve. 

- The tire pressures should only be checked and adjusted when the tires are cold. The slightly raised pressures of warm tires must not be reduced.
- Adjust the tire pressure to the load you are carrying.
- Reinstall the valve stem cap on the valve.

When should I check the tire pressure?

The correct tire pressure is especially important at high speeds. The pressure should therefore be checked at least once a month and always before starting a journey. Do not forget to check the tire pressure for the spare wheel ⇒ *page 271*.

When should I adjust the tire pressures?

Adjust the tire pressure to the load you are carrying. After changing a wheel or replacing wheels you have to adjust the tire pressures on all wheels. In addition, you must then initialize the new tire pressures in the tire pressure monitoring system* ⇒ *page 264*.

WARNING

Incorrect tire pressures and/or underinflation can lead sudden tire failure, loss of control, collision, serious personal injury or even death.

- When the warning symbol  appears in the instrument cluster, stop and inspect the tires.
- Incorrect tire pressure and/or underinflation can cause increased tire wear and can affect the handling of the vehicle and stopping ability.
- Incorrect tire pressures and/or underinflation can also lead to sudden tire failure, including a blowout and sudden deflation, causing loss of vehicle control.
- The driver is responsible for the correct tire pressures for all tires on the vehicle. The applicable pressure values are located on a sticker on the driver's side B-pillar or on the inside of the fuel filler flap.

WARNING (continued)

- Only when all tires on the vehicle are filled to the correct pressure, the tire pressure monitoring system* can work correctly.
- The use of incorrect tire pressure values can lead to accidents or other damage. Therefore it is essential that the driver observe the specified tire pressure values for the tires and the correct pressures for the function of the tire pressure monitoring system*.
- Always inflate tires to the recommended and correct tire pressure before driving off.
- Driving with underinflated tires bend more, letting them get too hot resulting in tread separation, sudden tire failure and loss of control.
- Excessive speed and/overloading can cause heat build-up, sudden tire failure and loss of control.
- If the tire pressure is too low or too high, the tires will wear prematurely and the vehicle will not handle well.
- If the tire is not flat and you do not have to change a wheel immediately, drive at reduced speed to the nearest service station to check the tire pressure and add air as required.

Note

Driving without valve stem caps can cause damage to the tire valves. To prevent this, always make sure that factory installed valve stem caps on all wheels are securely mounted on the valve.

For the sake of the environment

Underinflated tires will also increase the fuel consumption. ■

Tires and vehicle load limits

There are limits to the amount of load or weight that any vehicle and any tire can carry. A vehicle that is overloaded will not handle well and ►

is more difficult to stop. Overloading can not only lead to loss of vehicle control, but can also damage important parts of the vehicle and can lead to sudden tire failure, including a blowout and sudden deflation that can cause the vehicle to crash.

Your safety and that of your passengers also depends on making sure that load limits are not exceeded. Vehicle load includes everybody and everything in and on the vehicle. These load limits are technically referred to as the vehicle's **Gross Vehicle Weight Rating** ("GVWR").

The "GVWR" includes the weight of the basic vehicle, all factory installed accessories, a full tank of fuel, oil, coolant and other fluids plus maximum load. The maximum load includes the number of passengers that the vehicle is intended to carry ("seating capacity") with an assumed weight of 150 lbs (68 kg) for each passenger at a designated seating position and the total weight of any luggage in the vehicle. If you tow a trailer, the weight of the trailer hitch and the tongue weight of the loaded trailer must be included as part of the vehicle load.

The **Gross Axle Weight Rating** ("GAWR") is the maximum load that can be applied at each of the vehicle's two axles.

The Gross Vehicle Weight Rating and the Gross Axle Weight Rating are listed on the safety compliance sticker label located either on the driver's side B-pillar or on the inside of the fuel filler flap. Your Audi has 5 seating positions, 2 in the front and 3 in the rear for total seating capacity of 5. Each seating position has a safety belt ⇒ *page 135, "Safety belts"*.

The fact that there is an upper limit to your vehicle's Gross Vehicle Weight Rating means that the total weight of whatever is being carried in the vehicle (including the weight of a trailer hitch and the tongue weight of the loaded trailer) is limited. The more passengers in the vehicle or passengers who are heavier than the standard weights assumed mean that less weight can be carried as luggage.

The tire pressure label on your Audi also lists the maximum combined weight of all of the occupants and luggage or other cargo that the vehicle can carry. For the location of the label ⇒ *page 249, fig. 171*.



WARNING

Overloading a vehicle can cause loss of vehicle control, a crash or other accident, serious personal injury, and even death.

- Carrying more weight than your vehicle was designed to carry will prevent the vehicle from handling properly and increase the risk of the loss of vehicle control.
- The brakes on a vehicle that has been overloaded may not be able to stop the vehicle within a safe distance.
- Tires on a vehicle that has been overloaded can fail suddenly, including a blowout and sudden deflation, causing loss of control and a crash.
- Always make sure that the total load being transported – including the weight of a trailer hitch and the tongue weight of a loaded trailer – does not make the vehicle heavier than the vehicle's Gross Vehicle Weight Rating. ■

Determining correct load limit

Use the example below to calculate the total weight of the passengers and luggage or other things that you plan to transport so that you can make sure that your vehicle will not be overloaded. ▶

Steps for Determining Correct Load Limit

1. Locate the statement “THE COMBINED WEIGHT OF OCCUPANTS AND CARGO SHOULD NEVER EXCEED XXX KG OR XXX LBS” on your vehicle’s placard (tire inflation pressure label) ⇒ *page 249*, fig. 171.
2. Determine the combined weight of the driver and passengers that will be riding in your vehicle.
3. Subtract the combined weight of the driver and passengers from “XXX” kilograms or “XXX” pounds shown on the sticker ⇒ *page 249*, fig. 171.
4. The resulting figure equals the available amount of cargo and luggage load capacity. For example, if the “XXX” amount equals 1400 lbs. and there will be five 150 lbs. passengers in your vehicle, the amount of available cargo and luggage load capacity is 650 lbs. (1400-750 (5 x 150) = 650 lbs.)
5. Determine the combined weight of luggage and cargo being loaded on the vehicle. That weight may not safely exceed the available cargo and luggage load capacity calculated in Step 4.
6. If your vehicle will be towing a trailer, load from your trailer will be transferred to your vehicle. Consult this manual to determine how this reduces the available cargo and luggage load capacity of your vehicle.
 - Check the tire sidewall (⇒ *page 257*, fig. 175) to determine the designated load rating for a specific tire. ■

Tire service life

The service life of tires depends on a lot of different things including proper installation and balancing, correct tire pressure and driving style.

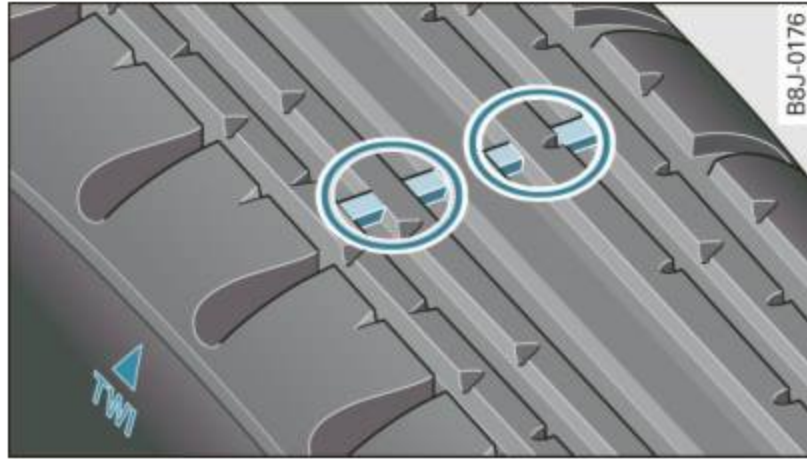

Fig. 173 Tire tread: tread wear indicators (TWI)

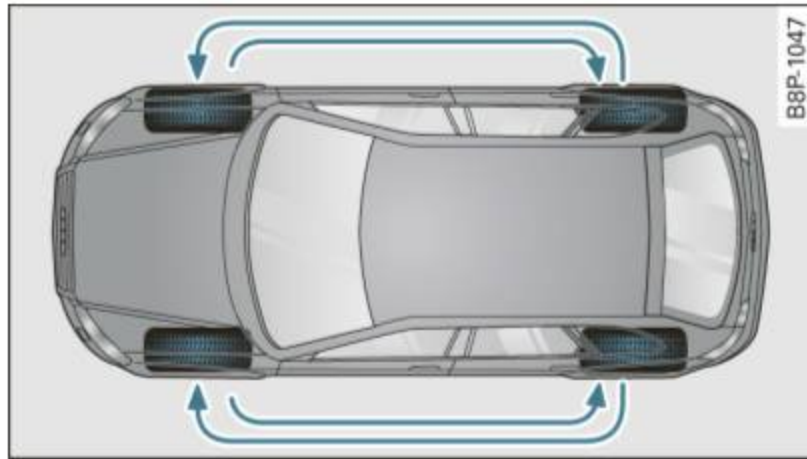

Fig. 174 Rotating tires for more even wear

Tread Wear Indicator (TWI)

The original tires on your vehicle have 1/16 inch (1.6 mm) high “wear indicators” ⇒ fig. 173 running across the tread. Depending on the make, there will be six to eight of them evenly placed around the tire. Marks on the tire sidewall (for example “TWI” or other symbols) indicate the positions of the tread wear indicators. Worn tires must be replaced. Different figures may apply in other countries ⇒ ⚠.

Tire pressure

Incorrect tire pressure causes premature wear and can cause sudden tire blow-out. For this reason, tire pressure must be checked at least once a month ⇒ page 252.

Driving style

Driving fast around curves, heavy acceleration and hard braking increase tire wear.

Rotating tires for more even wear

For all four tires on your vehicle to have the same service life, we recommend that the front and rear tires are rotated according to the tire manufacturer's suggested tire rotation intervals. Please remember the following:

- Tire rotation intervals may differ from the vehicle service intervals outlined in your Warranty & Maintenance Booklet.
- The longer one tire is used in one location on the vehicle, the more it wears at certain points; therefore, we recommend that you follow the tire manufacturer's suggested tire rotation intervals.
- Vehicles with front-wheel drive experience more tread wear on the front wheels compared to all-wheel drive (quattro®).
- Please rotate tires as shown ⇒ page 256, fig. 174.
- Extra care must be taken when rotating direction-specific tires ⇒ page 279.

Wheel balancing

The wheels on new vehicles are balanced. However, various situations during everyday driving can cause them to become unbalanced, resulting in vibrations you can usually feel through the steering wheel.

Unbalanced wheels must be rebalanced to avoid excessive wear on steering, suspension and tires. A wheel must also be rebalanced when a new tire is installed. ▶

Incorrect wheel alignment

Incorrect wheel alignment can cause excessive tire wear, impairing the safety of the vehicle. If tires show excessive wear, have the wheel alignment checked by an authorized Audi dealer or qualified workshop.

All Wheel Drive

Vehicles with quattro® must always have tires of the same size, construction and tread type. For details see ⇒ page 194.

WARNING

Sudden tire failure can lead to loss of control, a crash and serious personal injury!

- Never drive a vehicle when the tread on any tire is worn down to the wear indicators.
- Worn tires are a safety hazard, they do not grip well on wet roads and increase your risk of “hydroplaning” and loss of control.
- Always keep chemicals that can cause tire damage, such as grease, oil, gasoline and brake fluid away from tires.
- Tires age even if they are not being used and can fail suddenly, especially at high speeds. Tires that are more than 6 years old can only be used in an emergency and then with special care and at lower speeds.
- Never mount used tires on your vehicle if you are not sure of their “previous history.” Old used tires may have been damaged even though the damage cannot be seen that can lead to sudden tire failure and loss of vehicle control. ■

New tires and replacing tires and wheels

New tires and wheels have to be broken in.

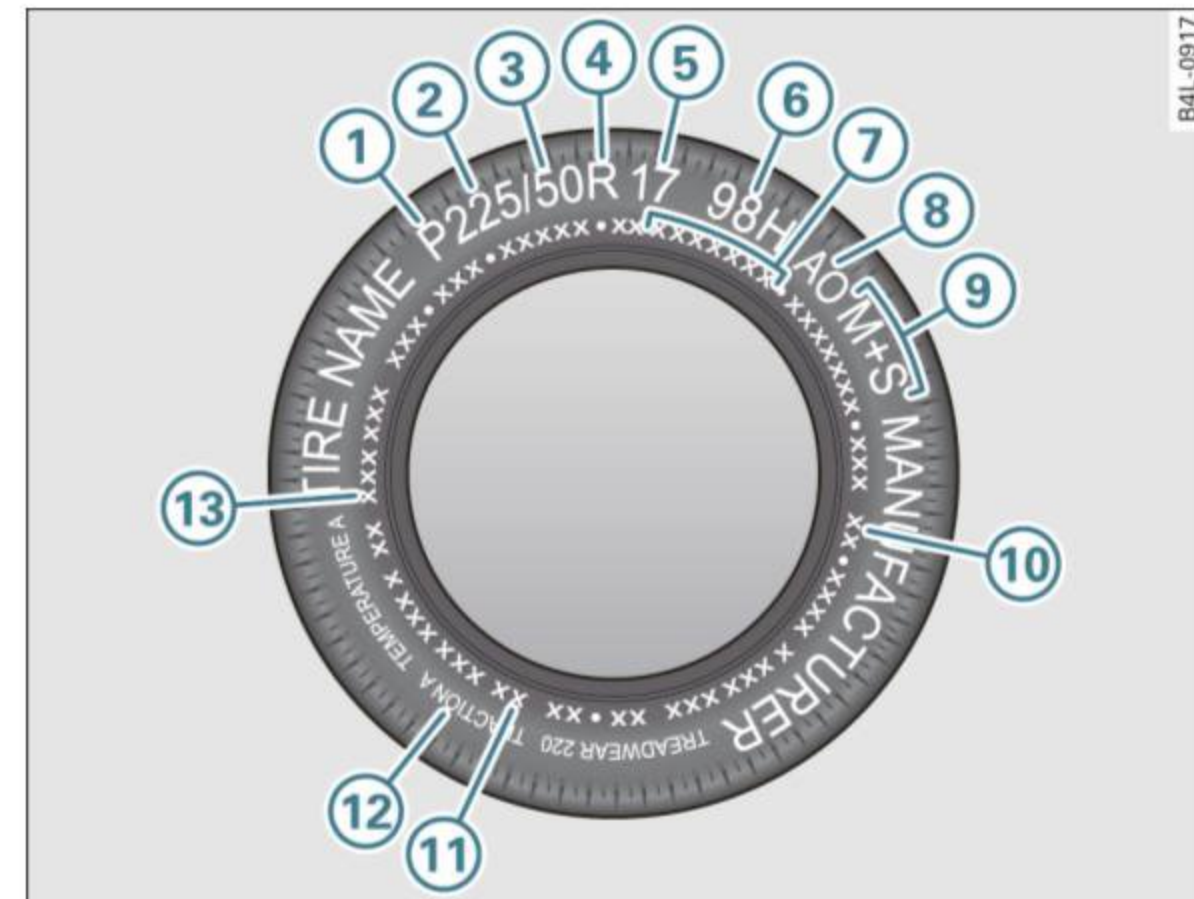

Fig. 175 Tire specification codes on the sidewall of a tire

No.	Description
①	Passenger car tire (where applicable)
②	Nominal width of tire in millimeters
③	Ratio of height to width (aspect ratio)
④	Radial
⑤	Rim diameter code
⑥	Load index and speed rating

⑦	U.S. DOT tire identification number
⑧	Audi Original tire
⑨	Tire ply composition and materials used
⑩	Maximum load rating
⑪	Treadwear, traction and temperature grades
⑫	Maximum permissible inflation pressure

The tires and rims are essential parts of the vehicle's design. The tires and rims approved by Audi are specially matched to the characteristics of the vehicle and can make a major contribution to good road holding and safe handling when in good condition and properly inflated ⇒ ⚠.

We recommend that all work on tires and wheels be performed by an authorized Audi dealer. They are familiar with recommended procedures and have the necessary special tools and spare parts as well as the proper facilities for disposing of the old tires.

Authorized Audi dealers have the necessary information about technical requirements for installing or changing tires and rims.

Replacing tires and wheels

Tires should be replaced at least in pairs and not individually (for example both front tires or both rear tires together).

Be sure to read and heed the tire pressure monitoring system* information ⇒ *page 264*.

Always buy replacement radial tires that have the same specifications as the tires approved for your vehicle by Audi. Replacement tires must always have the same load rating specification as the original equipment or approved optional tires listed in the table ⇒ *page 249*.

Audi-approved specification tires are specially matched to your vehicle and its load limits, and can contribute to the important road-holding, driving characteristics, and safety of the vehicle. The table

(⇒ *page 249*) lists specifications of the tires approved for the Audi models covered by your Owner's Literature.

The tire pressure label located either on driver's side B-pillar or inside the fuel filler flap (⇒ *page 249*, fig. 172) lists the specifications of the original equipment tires installed on your vehicle at the time it was manufactured.

Federal law requires tire manufacturers to place standardized information on the sidewall of all tires ⇒ *page 257*, fig. 175. This information identifies and describes the fundamental characteristics, the quality grade of the tire and also provides a tire identification number for safety standard certification and in case of a recall.

Tire specifications

Knowledge of tire specifications makes it easier to choose the correct tires. Radial tires have the tire specifications marked on the sidewall, for example:

P225 / 45 R 17 91H XL

This contains the following information:

- P** Indicates the tire is for passenger cars (where applicable)
- 225** Nominal tire width in mm of the tire from sidewall edge to sidewall edge. In general, the larger the number, the wider the tire
- 45** Height/width ratio in percent (aspect ratio)
- R** Tire construction: **Radial**
- 17** Rim diameter code (in inches)
- 91** Load rating code
- H** Speed rating letter code
- XL** (or "xl", "EXTRA LOAD" or "RF") indicates that the tire is "Reinforced" or an "Extra Load" tire
- M+S** (or "M/S") Indicates that the tire has some mud and snow capability

The tires could also have the information of direction of rotation ⇒ *page 245*.

Tire manufacturing date

The manufacturing date is also indicated on the tire sidewall (possibly only on the *inner* side of the wheel):

“DOT ... 2209...” means, for example, that the tire was produced in the 22nd week of 2009.

Speed rating (letter code)

The speed rating letter code on the wheels indicates the maximum permissible road speeds ⇒  in “Winter tires” on *page 261*.

P	up to 93 mph (150 km/h)
Q	up to 99 mph (158 km/h)
R	up to 106 mph (170 km/h)
S	up to 110 mph (180 km/h)
T	up to 118 mph (190 km/h)
U	up to 124 mph (200 km/h)
H	up to 130 mph (210 km/h)
V	up to 149 mph (240 km/h) ⁶⁾
Z	over 149 mph (240 km/h) ⁶⁾
W	up to 168 mph (270 km/h) ⁶⁾
Y	up to 186 mph (298 km/h) ⁶⁾

Your vehicle is normally factory equipped with tires, which possess excellent driving characteristics and give your Audi optimum driving comfort. An electronic speed limiter ⇒ *page 20* will normally prevent your vehicle from going faster than the tire speed rating ⇒ .

U.S. DOT Tire Identification Number (TIN) and tire manufacture date

This is the tire’s “serial number”. It begins with the letters “DOT” and indicates that the tire meets all federal standards. The next two numbers or letters indicate the plant where it was manufactured, and the last four numbers represent the week and year of manufacture. For example, the numbers 2209 mean that the tire was produced in

⁶⁾ For tires with a maximum speed capability over 149 mph (240 km/h), tire manufacturers sometimes use the letters “ZR.”

the 22nd week of 2009. The other numbers are marketing codes that may or may not be used by the tire manufacturer. This information is used to contact consumers if a tire defect requires a recall.

Audi Original tire

Tires with the identification “AO” or “RO” have been specially matched with your Audi. We recommend using only these tires because they meet the highest standards regarding safety and driving characteristics when used correctly. Your authorized Audi dealer will gladly provide you with more information.

Maximum Load Rating

This number indicates the maximum load in kilograms and pounds that can be carried by the tire.

Tire quality grading for treadwear, traction, and temperature resistance

Tread wear, traction and temperature grades ⇒ *page 260*.

Maximum Permissible Inflation Pressure

This number is the greatest amount of air pressure that should ever be put in the tire under normal driving conditions.

WARNING

- Using incorrect or unmatched tires and / or wheels or improper tire and wheel combinations can lead to loss of control, collision and serious personal injury.
- Always use tires, rims and wheel bolts that meet the specifications of original factory-installed tires or other combinations that have been specifically approved by the vehicle manufacturer.
- Tires age even if they are not being used and can fail suddenly, especially at high speeds. Tires that are more than 6 years old can only be used in an emergency and then with special care and at lower speeds.
- Never mount used tires on your vehicle if you are not sure of their “previous history.” Old used tires may have been damaged

 **WARNING** (continued)

even though the damage cannot be seen that can lead to sudden tire failure and loss of vehicle control.

- All four wheels must be fitted with radial tires of the same type, size (rolling circumference) and the same tread pattern. Driving with different tires reduces vehicle handling and can lead to a loss of control.
- If the spare tire is not the same as the tires that are mounted on the vehicle - for example with winter tires - only use the spare tire for a short period of time and drive with extra care. Refit the normal road wheel as soon as safely possible.
- Never drive faster than the maximum speed for which the tires on your vehicle are rated because tires that are driven faster than their rated speed can fail suddenly.
- Overloading tires cause heat build-up, sudden tire failure, including a blowout and sudden deflation and loss of control.
- Temperature grades apply to tires that are properly inflated and not over or underinflated.
- For technical reasons it is not always possible to use wheels from other vehicles – in some cases not even wheels from the same vehicle model.
- If you install wheel trim discs on the vehicle wheels, make sure that the air flow to the brakes is not blocked. Reduced airflow to the brakes can them to overheat, increasing stopping distances and causing a collision.
- Run flat tires may only be used on vehicles that were equipped with them at the factory. The vehicle must have a chassis designed for run flat tires and a factory-installed tire pressure monitoring system* that indicates a loss of tire pressure. Incorrect use of run flat tires can lead to vehicle damage or accidents. Check with an authorized Audi dealer or tire specialist to see if your vehicle can be equipped with run flat tires. If run flat tires are used, they must be installed on all four wheels. Mixing tire types is not permitted.

 **Note**

- For technical reasons, it is not generally possible to use the wheel rims from other vehicles. This can hold true for wheels of the same vehicle type.
- If the spare tire is different from the tires that you have mounted on your vehicle (for example winter tires or wide profile tires), then use the spare tire for a short period of time only and drive with extra care. Replace the flat tire with the tire matching the others on your vehicle as soon as possible.
- If you put different wheels and tires on your vehicle (e.g. winter wheels and tires), you must be certain that the wheels and tires are compatible with the tire pressure monitoring system*. Otherwise the system will register a malfunction and a fault message will be displayed. For more information, contact your authorized Audi dealer.
- Never drive without the valve stem cap. The valves could get damaged.

**For the sake of the environment**

Dispose of old tires in accordance with the local requirements. ■

Uniform tire quality grading

- Tread wear
- Traction AA A B C
- Temperature A B C

Quality grades can be found where applicable on the tire side wall between tread shoulder and maximum section width ⇒ *page 257*, fig. 175.

For example: Tread wear **200**, Traction **AA**, Temperature **A**.

All passenger car tires must conform to Federal Safety Requirements in addition to these grades. ►

Tread wear

The *tread wear* grade is a comparative rating based on the wear rate of the tire when tested under controlled conditions on a specified government test course.

For example, a tire graded 150 would wear one and one half (1 1/2) times as well on the government course as a tire graded 100.

The relative performance of tires depends upon the actual conditions of their use, however, and may depart significantly from the norm due to variations in driving habits, service practices and differences in road characteristics and climate.

Traction

The *traction* grades, from highest to lowest, are AA, A, B and C. Those grades represent the tire's ability to stop on wet pavement as measured under controlled conditions on specified government test surfaces of asphalt and concrete. A tire marked C may have poor traction performance ⇒ ⚠.

Temperature

The *temperature* grades are A (the highest), B, and C, representing the tire's resistance to the generation of heat and its ability to dissipate heat when tested under controlled conditions on a specified indoor laboratory test wheel.

Sustained high temperature can cause the material of the tire to degenerate and reduce tire life, and excessive temperature can lead to sudden tire failure ⇒ ⚠.

The grade C corresponds to a level of performance which all passenger car tires must meet under the Federal Motor Vehicle Safety Standard No. 109. Grades B and A represent higher levels of performance on the laboratory test wheel than the minimum required by law.

⚠ WARNING

The traction grade assigned to this tire is based on straight-ahead braking traction tests, and does not include acceleration, cornering, hydroplaning or peak traction characteristics.

⚠ WARNING

The temperature grade for this tire is established for a tire that is properly inflated and not overloaded. Excessive speed, underinflation, or excessive loading, either separately or in combination, can cause heat buildup and possible tire failure. ■

Winter tires

Winter tires can improve vehicle handling on snow and ice. At temperatures below 45 °F (7 °C) we recommend changing to winter tires.

In some heavy snow areas, local governments may require true winter or "snow" tires, those with very deeply cut tread. These tires should only be used in pairs and be installed on all four wheels. Make sure you purchase snow tires that are the same size and construction type as the other tires on your vehicle.

If your vehicle is equipped with all-wheel drive*, this will improve traction during winter driving, even with the standard tires. However, we strongly recommend that you always equip all four wheels on your vehicle with correctly fitted winter tires or all-season tires, when winter road conditions are expected. This also improves the vehicle's braking performance and reduces stopping distances.

Summer tires provide less grip on ice and snow.

Winter tires (snow tires) must always be fitted on all four wheels.

Ask your authorized Audi dealer or qualified workshop for permitted **winter tire sizes**. Use only radial winter tires. ►

Winter tires lose their effectiveness when the tread is worn down to a depth of 0.157 inch (4 mm).

Only drive with winter tires under winter conditions. Summer tires handle better when there is no snow or ice on the roads and the temperature is above 45 °F (7 °C).

If you have a flat tire, see notes on spare wheel ⇒ *page 257*.

Please always remember that winter tires may have a lower speed rating than the tires originally installed on your vehicle at the time it was manufactured. Please see ⇒ *page 259*, “Speed rating (letter code)” for a listing of the speed rating letter codes and the maximum speed at which the tires can be driven.

The speed rating letter code (⇒ *page 259*) is on the side wall of the tire ⇒ *page 257*.

WARNING

Winter tires have maximum speed limits that may be lower than your vehicle's maximum speed. Always know the maximum speed before driving off. Never drive faster than the speed permitted for your specific winter tires. This will cause damage to the tires leading to an accident and serious personal injury to you and your passengers.

WARNING

Driving faster than the maximum speed for which the winter tires on your vehicle were designed can cause tire failure including a blowout and sudden deflation, loss of control, crashes and serious personal injuries. Have worn or damaged tires replaced immediately.

- Winter tires have maximum speed rating that may be lower than your vehicle's maximum speed.
- Never drive faster than the speed for which the winter or other tires installed on your vehicle are rated.

WARNING

Always adjust your driving to the road and traffic conditions. Never let the good acceleration of the winter tires and all-wheel drive tempt you into taking extra risks. Always remember:

- When braking, an all-wheel drive vehicle handles in the same way as a front drive vehicle.
- Drive carefully and reduce your speed on icy and slippery roads, even winter tires cannot help under black ice conditions.

For the sake of the environment

Use summer tires when weather conditions permit. They are quieter, do not wear as quickly and reduce fuel consumption. ■

Snow chains

Snow chains may be fitted only to the front wheels, and only to certain tire sizes. Ask your authorized Audi dealer on which tire sizes snow chains can be used.

If you are going to use snow chains, then you must install them on the front wheels at least.

The snow chains must have low-profile links and must not be thicker than 0.53 inch (13.5 mm), including the lock.

Remove wheel center covers and trim discs before putting snow chains on your vehicle ⇒ . For safety reasons cover caps must then be fitted over the wheel bolts. These are available from authorized Audi dealers.

WARNING

Using the wrong snow chains for your vehicle or installing them incorrectly can increase the risk of loss of control leading to serious personal injury.

⚠ WARNING (continued)

- **Snow chains are available in different sizes. Always make sure to follow the instructions provided by the snow chain manufacturer.**
- **When driving with snow chains never drive faster than the speed permitted for your specific snow chains.**
- **Always observe local regulations.**

! Note

- Remove snow chains before driving on roads not covered with snow to avoid damaging tires and wearing the snow chains down unnecessarily.
- Snow chains, which come into direct contact with the wheel rim, can scratch or damage it. Therefore, make sure that the snow chains are suitably covered. Check the position of the snow chains after driving a few yards and correct if necessary. Follow the instructions from the snow chain manufacturer when doing so.

i Tips

- Where snow chains are mandatory on certain roads, this normally also applies to vehicles with All Wheel Drive.
- If snow chains are installed, the tire pressures should not be stored in the tire pressure monitoring system (TPMS). Otherwise the system could malfunction ⇒ *page 267*. ■

Wheel bolts

Wheel bolts must always be tightened to the correct torque.

The design of wheel bolts is matched to the factory installed rims. If different rims are fitted, the correct wheel bolts with the right length and correctly shaped bolt heads must be used. This ensures that

wheels are fitted securely and that the brake system functions correctly.

In certain circumstances, you may not use wheel bolts from a different vehicle – even if it is the same model.

⚠ WARNING

Improperly tightened or maintained wheel bolts can become loose causing loss of control, a collision and serious personal injury.

- **Always keep the wheel bolts and the threads in the wheel hubs clean so the wheel bolts can turn easily and be properly tightened.**
- **Never grease or oil the wheel bolts and the threads in the wheel hubs. They can become loose while driving if greased or oiled, even if tightened to the specified torque.**
- **Only use wheel bolts that belong to the rim being installed.**
- **Never use different wheel bolts on your vehicle.**
- **Always maintain the correct tightening torque for the wheel bolts to reduce the risk of a wheel loss. If the tightening torque of the wheel bolts is too low, they can loosen and come out when the vehicle is moving. If the tightening torque is too high, the wheel bolts and threads can be damaged and the wheel can become loose.**

! Note

The specified torque for the wheel bolts is 90 ft lb (120 Nm) with a tolerance of $\pm 7,4$ ft lb (± 10 Nm). Torque wheel bolts diagonally. After changing a wheel, the torque must be checked as soon as possible with a torque wrench – preferably by an authorized Audi dealer or qualified workshop. ■

Low aspect ratio tires

Your Audi is factory-equipped with low aspect ratio tires. These tires have been thoroughly tested and been selected specifically for your model for their superb performance, road feel and handling under a variety of driving conditions. Ask your authorized Audi dealer for more details.

The low aspect ratio of these tires is indicated by a numeral of **55 or less** in the tire's size designation. The numeral represents the ratio of the tire's sidewall height in relation to its tread width expressed in percentage. Conventional tires have a height/width ratio of 60 or more.

The performance of low-aspect-ratio tires is particularly sensitive to improper inflation pressure. It is therefore important that low aspect ratio tires are inflated to the specified pressure and that the inflation pressure is regularly checked and maintained. Tire pressures should be checked at least once a month and always before a long trip ⇒ page 252, "Checking tire pressure".

What you can do to avoid tire and rim damage

Low aspect ratio tires can be damaged more easily by impact with potholes, curbs, gullies or ridges on the road, particularly if the tire is underinflated.

In order to minimize the occurrence of impact damage to the tires of your vehicle, we recommend that you observe the following precautions:

- Always maintain recommended inflation pressures. Check your tire pressure every 2,000 miles (3,000 km) and add air if necessary.
- Drive carefully on roads with potholes, deep gullies or ridges. The impact from driving through or over such obstacles can damage your tires. Impact with a curb may also cause damage to your tires.
- After any impact, immediately inspect your tires or have them inspected by the nearest authorized Audi dealer. Replace a damaged tire as soon as possible.

- Inspect your tires every 2,000 miles (3,000 km) for damage and wear. Damage is not always easy to see. Damage can lead to loss of air and underinflation, which could eventually cause tire failure. If you believe that a tire may have been damaged, replace the tire as soon as possible.
- These tires may wear more quickly than others.
- Please also remember that, while these tires deliver responsive handling, they may ride less comfortably and make more noise than other choices.

Reduced performance in winter/cold season conditions

All tires are designed for certain purposes. The low aspect ratio, ultra high performance tires originally installed on your vehicle are intended for maximum dry and wet road performance and handling. They are not suitable for cold, snowy or icy weather conditions. If you drive under those circumstances, you should equip your vehicle with all-season or winter tires, which offer better traction under those conditions. We suggest you use the recommended snow or all-season tires specified for your vehicle, or their equivalent.

Refer to ⇒ page 261 for more detailed information regarding winter tires. ■

Tire pressure monitoring system

Applies to vehicles: with tire pressure monitoring system

General notes (⚠)

Each tire, including the spare (if provided), should be checked monthly when cold and inflated to the inflation pressure recommended by the vehicle manufacturer on the vehicle placard or tire inflation pressure label. (If your vehicle has tires of a different size than the size indicated on the vehicle placard or tire inflation pressure label, you should determine the proper tire inflation pressure for those tires.)

As an added safety feature, your vehicle has been equipped with a tire pressure monitoring system (TPMS) that illuminates a low tire pressure telltale when one or more of your tires is significantly under-inflated. Accordingly, when the low tire pressure telltale illuminates, you should stop and check your tires as soon as possible, and inflate them to the proper pressure. Driving on a significantly under-inflated tire causes the tire to overheat and can lead to tire failure. Under-inflation also reduces fuel efficiency and tire tread life, and may affect the vehicle's handling and stopping ability.

Please note that the TPMS is not a substitute for proper tire maintenance, and it is the driver's responsibility to maintain correct tire pressure, even if under-inflation has not reached the level to trigger illumination of the TPMS low tire pressure telltale.

Your vehicle has also been equipped with a TPMS malfunction indicator to indicate when the system is not operating properly. The TPMS malfunction indicator is combined with the low tire pressure telltale. When the system detects a malfunction, the telltale will flash for approximately one minute and then remain continuously illuminated. This sequence will continue upon subsequent vehicle start-ups as long as the malfunction exists.

When the malfunction indicator is illuminated, the system may not be able to detect or signal low tire pressure as intended. TPMS malfunctions may occur for a variety of reasons, including the installation of replacement or alternate tires or wheels on the vehicle that prevent the TPMS from functioning properly. Always check the TPMS malfunction telltale after replacing one or more tires or wheels on your vehicle to ensure that the replacement or alternate tires and wheels allow the TPMS to continue to function properly. ■

Applies to vehicles: with tire pressure monitoring system

Tire pressure indicator appears

The tire pressure indicator in the instrument cluster informs you if the tire pressure is too low or if there is a system malfunction.



Fig. 176 Display: underinflation warning



Fig. 177 Display: System malfunction



Using the ABS sensors, the tire pressure monitoring system compares the tire tread circumference and vibration characteristics of the individual tires. If the pressure decreases in one or more tires, this is indicated in the instrument cluster with a warning symbol (⚠) and a message ⇒ fig. 176. The driver message in the display goes out after 5 seconds. The driver message can be displayed again by pressing the **CHECK** button (6) ⇒ page 8, fig. 2. If only one tire is affected, the display will indicate its position. ▶

The tire pressure monitoring must be reset in the menu display each time the pressures are adjusted (e. g. when switching between partial and full load pressure) or after changing or replacing a tire on your vehicle ⇒ *page 267*. You can find the recommended tire pressures for your vehicle on the label on the driver's door pillar ⇒ *page 249*.

Tire tread circumference and vibration characteristics can change and cause a tire pressure warning if:

- the tire pressure in one or more tires is too low,
- the tire has structural damage,
- the tire pressure was changed, wheels rotated or replaced but the TPMS was not reset ⇒ *page 267*.

Warning symbols

 Loss of pressure in at least one tire ⇒ . Check the tire or tires and replace or repair if necessary. The indicator light  in the instrument cluster also illuminates ⇒ *page 11*. Check/correct the pressures of all four tires and reset TPMS in the menu display.

TPMS (Tire Pressure Monitoring System) Tire pressure! System malfunction. If **TPMS** appears after switching the ignition on or while driving ⇒ *page 265*, fig. 177 and the indicator light  in the instrument cluster blinks for approximately one minute and then stays on, there is a system malfunction. See your authorized Audi dealer as soon as possible.

WARNING

- **If the tire pressure indicator appears in the instrument cluster display, one or more of your tires is significantly under-inflated. Reduce your speed immediately and avoid any hard steering or braking maneuvers. Stop as soon as possible and check the tires and their pressures. Inflate the tire pressure to the proper pressure as indicated on the vehicle's tire pressure label ⇒ *page 249*. Driving on a significantly under-inflated tire causes the tire to overheat and can lead to tire failure. Under-inflation also is likely to impair the vehicle's handling and stopping ability.**

WARNING (continued)

- **The driver is responsible for maintaining the correct tire pressures. You must check the tire pressures regularly.**
- **Under certain conditions (such as a sporty driving style, winter conditions or unpaved roads), the pressure monitor indicator may be delayed.**
- **Ask your authorized Audi dealer if run-flat tires may be used on your vehicle. Your vehicle registration becomes invalid if you use these tires when not permitted. Damage to your vehicle or accidents could also result.**

Tips

- The tire pressure monitoring system stops working when there is an ESP/ABS malfunction.
- Using snow chains may result in a system malfunction.
- Tires with the identification "AO" or "RO" have been specially matched with your Audi. We recommend using only these tires because they meet the highest standards regarding safety and driving characteristics when used correctly. Your authorized Audi dealer will gladly provide you with more information. ■

Applies to vehicles: with tire pressure monitoring system

Reset tire pressure monitoring system (Step1)

If the tire pressure is adjusted, wheels are rotated or changed, the TPMS must be reset in the menu display.



Fig. 178 Wiper lever: Controls for the menu display

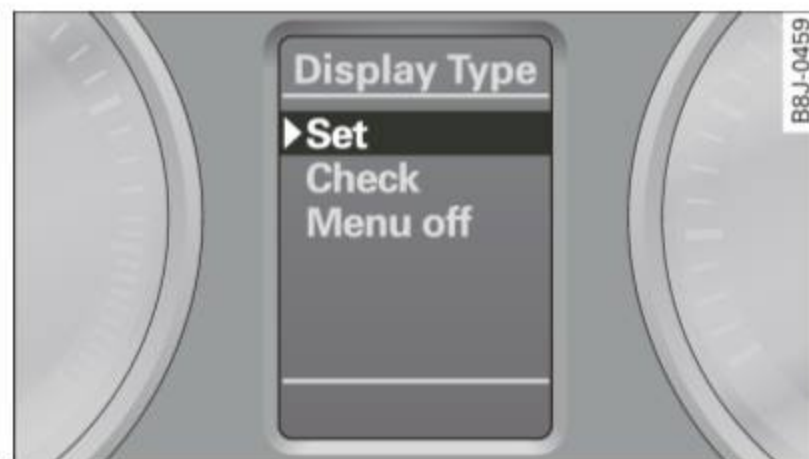

Fig. 179 Display: Start menu

Reset button (B) and **rocker switch** (A) ⇒ fig. 178 functions:

To open the menu

- Press the **Reset** button (B) until the menu display ⇒ fig. 179 appears

Selections and settings

- Press the rocker switch (A) to reach a menu display. The switch is operated the same as the display (up/down).

Entering and confirming

- Press the **Reset** button (B).

Returning to the Start menu

- Press the **Reset** button longer than 2 seconds to return from any menu level to the Start menu.

i Tips

- Before resetting the TPMS, the current pressures of **all four tires** must correspond to the specified values. Adjust the tire pressure and reset the pressure in the tire pressure monitoring system according to the load you are carrying ⇒ *page 249*.
- Do not store the tire pressures if snow chains are installed. Otherwise the system could malfunction. ■

Applies to vehicles: with tire pressure monitoring system

Reset tire pressure monitoring system (Step2)



Fig. 180 Display: Tire pressure



Fig. 181 Display: Tire pressure

reset the pressure in the tire pressure monitoring system according to the load you are carrying ⇒ *page 249*. ■

Reset button (B) and **rocker switch** (A) ⇒ *page 267*, fig. 178 functions:

Storing tire pressures

- Turn on the ignition.
- Select the menu: > **Adjusting*** > **Tire pressure** > **Store**.

Entering and confirming

- Select the menu: Store now
- Press the **Reset** button (B).
- Select the menu: Confirm
- Press the **Reset** button (B).

Returning to the Start menu

- Press the **Reset** button longer than 2 seconds to return from any menu level to the Start menu.

Tips

Before resetting the TPMS, the current pressures of **all four tires** must correspond to the specified values. Adjust the tire pressure and

What do I do now?

Jack, tools and spare wheel

Jack and tools

The tools and jack are stored underneath the floor panel in the luggage compartment.

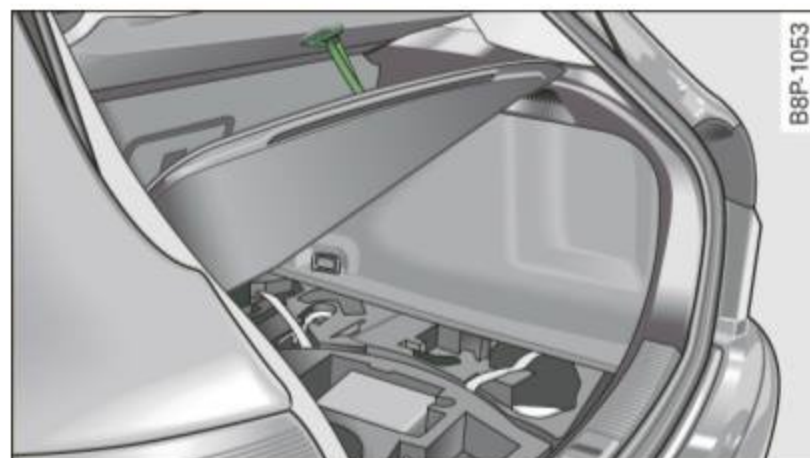

Fig. 182 Floor panel hung on the bottom of the luggage compartment cover

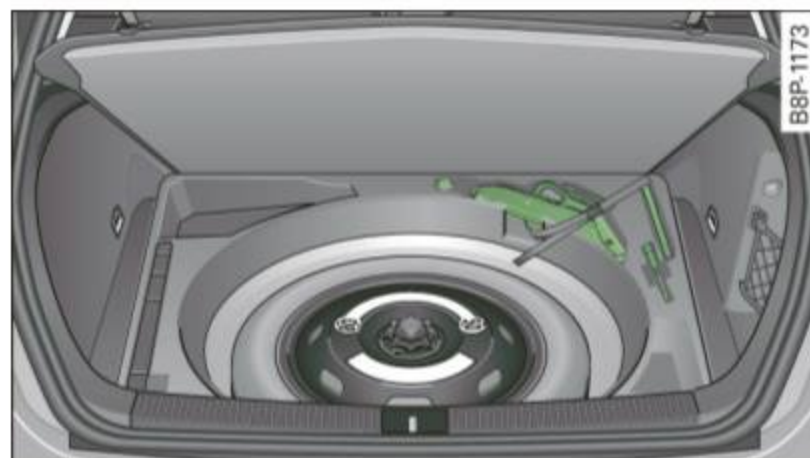

Fig. 183 Vehicle tool kit and jack

- Raise the floor panel with the loop.
- Hang the loop on the underside of the luggage compartment cover ⇒ fig. 182.
- Remove the tool kit or the jack.

The onboard tool kit includes:

- Hook for removing wheel covers*
- Plastic hook to remove wheel bolt covers
- Wheel bolt wrench
- Alignment pin for changing wheels
- Screwdriver with reversible blade
- Towing eye

Before storing the jack, make sure it is wound back down as far as it will go.

After use, the jack and tools must be put back in place underneath the floor panel in the luggage compartment.

Note: some of the on-board items listed above are provided on certain models only or are optional extras.

WARNING

Improper use of the vehicle jack can cause serious personal injuries.

- Using a bumper jack to raise the vehicle will damage the bumper system. The jack may slip, causing injury.
- Never support your vehicle on cinder blocks, bricks or other objects. These may not be able to support the load and could cause injury when they fail.
- Never start or run the engine while the vehicle is supported by the jack.
- If you must work under the vehicle, always use safety stands specifically designed for this purpose.
- Never try and use the hexagonal socket in the handle of the screwdriver to loosen or tighten the wheel bolts.

⚠ WARNING (continued)

- Always make sure the spare tire and even a flat tire are secured in place and not loose, otherwise they could fly forward, causing personal injury to passengers in the vehicle in an accident or sudden maneuver.
- Never use the jack supplied with your Audi on another vehicle, particularly on a heavier one. The jack is only suitable for use on the vehicle it came with. ■

Applies to vehicles: with compact spare wheel

Compact spare wheel

The compact spare wheel is only intended to be used for a short time.



Fig. 184 Compact spare wheel in the wheel well

You will find the compact spare wheel under the floor in the luggage compartment. It is secured with a large nut.

Using the compact spare wheel

The compact spare wheel is only intended for emergencies until you can reach a repair shop. Replace it as quickly as possible with a normal wheel.

There are some restrictions on the use of the compact spare wheel ⇒ ⚠. The compact spare wheel has been developed especially for

your type of vehicle. It must not be exchanged for the compact spare wheel from another type of vehicle.

Normal summer or winter tires must not be installed on the compact spare wheel rim.

Snow chains

For technical reasons, the use of snow chains on the compact spare wheel is **not permitted**.

If you do have to drive with snow chains and have a tire failure on a *front wheel*, install the spare wheel in place of a rear wheel. Install the snow chains on the rear wheel and use it to replace the defective front wheel.

Using the spare wheel

The spare wheel is only intended for emergencies until you can reach a repair shop. Replace it as quickly as possible with a normal wheel.

There are some restrictions on the use of a spare wheel ⇒ ⚠. The spare wheel has been developed especially for your type of vehicle. It must not be exchanged for the spare wheel from another type of vehicle.

Normal summer or winter tires must not be installed on the spare wheel rim.

Snow tires

For technical reasons, the use of snow chains on the spare wheel is **not permitted**.

If you do have to drive with snow chains and have a tire failure on a *front wheel*, install the spare wheel in place of a rear wheel. Install the snow chains on the rear wheel and use it to replace the defective front wheel.

⚠ WARNING

Always store jacking equipment, spare wheel in the luggage compartment. Tighten screw for the spare wheel securely. Under ▶

 WARNING (continued)

no circumstances should you store the spare wheel or jack and tools unsecured in the passenger compartment. This could cause serious personal injury to passengers in the vehicle in case of a collision.

- The compact spare tire is for temporary use only and is so marked on the sidewalls.
- Do not drive at speeds exceeding 50 mph (80 km/h) with the compact spare wheel mounted. Also rapid acceleration, hard braking and hard cornering must be avoided to help prevent loss of vehicle control.
- Any continuous road use of the compact spare tire may result in tire failure, loss of vehicle control and injury to vehicle occupants.
- Do not put a snow chain on your compact spare tire. Due to the smaller tire size, the chain will not fit properly and can thus damage your vehicle. You could also lose the chain, as well as control of the vehicle.
- If you have a flat front tire in road conditions which require snow chains, first remove the undamaged rear wheel and mount the compact spare wheel in its place. Then remove the damaged front wheel, take the snow chains off it and attach them to the wheel taken from the rear. This wheel can now be mounted on the front with its snow chains. Check and adjust tire pressure promptly.
- Never use two or more compact spare tires at the same time.

 Note

When using the compact spare wheel, note the following:

- After installing the compact spare wheel, the tire inflation pressure should be checked and, if necessary, increased to 60 psi (4.2 bar).

- The load carrying capacity is marked on the tire sidewalls and must not be exceeded.
- After installing the compact spare wheel, make sure that you remount the flat tire in its storage area properly.
- The compact spare tire should be properly remounted in its storage area as soon as the standard road tire can be replaced.
- Because the compact spare tire was specifically designed for your vehicle, it must not be used on any other vehicle. Likewise, compact spare wheels from other vehicles must not be used on your vehicle.
- The compact spare tire must not be mounted on any other wheels, nor must standard tires, snow tires, wheel covers or trim rings be used with the compact spare wheel. If such use is attempted, damage to these items or other vehicle components may occur.



 Tips

Check the inflation pressure of the compact spare tire (60 psi/4.2 bar) periodically to keep the tire ready for use. ■

Wheel change

Before changing a wheel

Observe the following precautions for your own and your passenger's safety when changing a wheel.

- After you experience a tire failure, pull the car well away from moving traffic and try to reach **level** ground before you stop ⇒ .
- All passengers should **leave the car** and move to a safe location (for instance, behind the guardrail) ⇒ .
- Apply the **parking brake** firmly ⇒ .



- Move **selector lever to position P** on an automatic transmission; put manual transmission in **first gear** ⇒ .
- If you are towing a trailer: unhitch the trailer from your vehicle.
- Take the **tool** and the **spare tire** ⇒ *page 270* out of the luggage compartment.

WARNING

You or your passengers could be injured while changing a wheel if you do not follow these safety precautions:

- If you have a flat tire, move a safe distance off the road. Turn off the engine, turn the emergency flasher on and use other warning devices to alert other motorists.
- Make sure that passengers wait in a safe place away from the vehicle and well away from the roadway and traffic.
- To help prevent the vehicle from moving suddenly and possibly slipping off the jack, always fully set the parking brake and block the wheel diagonally opposite the wheel being changed. When one front wheel is lifted off the ground, placing the automatic transmission in “P” (Park), or engaging a gear in a manual transmission will *not* prevent the vehicle from moving.
- Before you change a wheel, be sure the ground is level and firm. If necessary, use a sturdy board under the jack.
- After installing the spare wheel, make sure that you remount the flat tire/wheel in its storage area properly and tighten the knurled retaining screw securely. ■

Changing a wheel

When you change a wheel, follow the sequence described below step-by-step and exactly in that order.

1. Remove the **decorative wheel cover***. For more details see also ⇒ *page 274*, “Decorative wheel covers” or ⇒ *page 275*, “Wheels with cap-covered wheel bolts”.
2. Loosen the **wheel bolts** ⇒ *page 276*.
3. Locate the proper mounting point for the jack and align the jack below that point ⇒ *page 276*.
4. **Lift** the car with the jack ⇒ *page 276*.
5. Take the **flat wheel off** and then put **the spare on** ⇒ *page 278*.
6. Tighten all wheel bolts lightly.
7. **Lower** the vehicle with the jack.
8. Use the wheel bolt wrench and **firmly** tighten all wheel bolts ⇒ *page 276*.
9. Put the decorative **wheel cover*** back on.

WARNING

Always read and heed all WARNINGS and information ⇒  in “Raising the vehicle” on *page 276* and ⇒ *page 279*. ■

After changing a wheel

A wheel change is not complete without the following actions.

- **Store and secure** the replaced wheel in the spare wheel well. ►

- Put the tool case and the jack back in place in the luggage compartment.
- Check the **tire pressure** on the spare wheel immediately after mounting it.
- As soon as possible, have the **tightening torques** on all wheel bolts checked with a torque wrench. The correct tightening torque is 90 ft lb (120 Nm).
- Have the flat tire **replaced** as soon as possible.

Tips

- If you notice while changing a tire that the wheel bolts are corroded and difficult to turn, then they should be replaced before you check the tightening torque.
- Drive at reduced speed until you have the tightening torques checked. ■

Applies to vehicles: with full wheel covers

Full wheel covers

The wheel covers must be removed to access the wheel bolts.

Removal

- Pull the **full wheel cover** off manually.

Installation

- First press the **full wheel cover** onto the rim at the cut-out provided for the valve. Then engage the outer edge of the **full wheel cover** in the steel rim. ■

Applies to vehicles: with decorative wheel covers

Decorative wheel covers

The decorative wheel covers must be removed first to access the wheel bolts.



Fig. 185 Wheel change: removing the wheel cover

Removing

- Insert the **hook** provided with the onboard tool kit into the hole on the center hub piece.
- Pull off the **decorative wheel cover** ⇒ fig. 185. ■

Applies to vehicles: with cap-covered wheel bolts

Wheels with cap-covered wheel bolts

The caps must be removed first from the wheel bolts before the bolts can be unscrewed.



Fig. 186 Wheel change: removing the wheel bolt caps

Removing

- Push the **plastic clip** provided with the onboard tool kit down over the wheel bolt cap until it engages.
- Pull on the properly engaged **plastic clip** to extract the cap ⇒ fig. 186.

Refitting

- Place the caps over the wheel bolts and push them back in.

The caps are there to protect and keep the wheel bolts clean. ■

Applies to vehicles: with anti-theft wheel bolts

Anti-theft wheel bolts

To tighten or untighten the anti-theft wheel bolts you must use a special adapter.

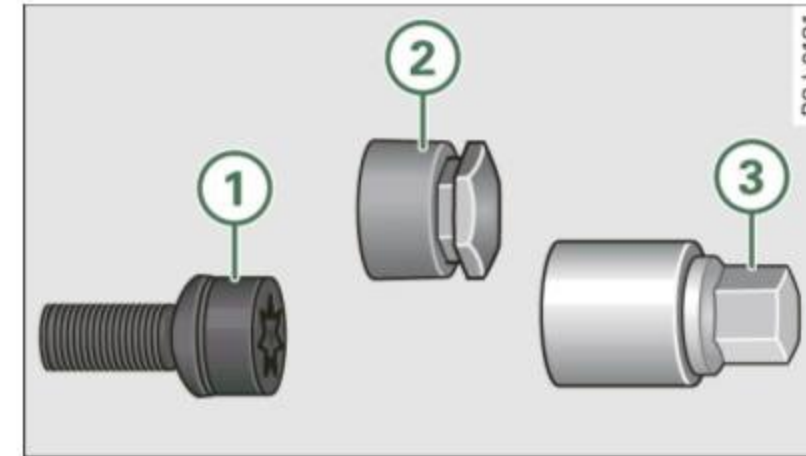

Fig. 187 Anti-theft wheel bolt with cap and adapter

- Remove the cap* ⇒ fig. 187 ② using the plastic clip found in the vehicle tool kit.
- Insert the adapter ③ as far as it will go into the anti-theft wheel ① bolt.
- Push the socket wrench over the adapter ③.
- Loosen or tighten the wheel bolt ⇒ page 276.

To remove the cap* ②, make sure the plastic clip is pushed in as far in as possible until it lines up with the edge of the cap.

We recommend you keep the wheel bolt adapter in the tool kit.

The **code number** of the wheel bolt lock is stamped on the front side of the adapter. You will need this number in order to get a replacement from your authorized Audi dealer.

Tips

Write down the code number and keep it in safe place. Do not keep it in the vehicle. ■

Loosening and tightening the wheel bolts

The wheel bolts must be loosened before raising the vehicle.



Fig. 188 Wheel change: loosening the wheel bolts

Loosening

- Fit the **wheel bolt wrench** over the wheel bolt and push it down as far as it will go.
- Close your grip around the *end* of the wrench handle for maximum torque and turn the wheel bolts **counter-clockwise** about *one single* turn in the direction of arrow ⇒ fig. 188.

Tightening

- Fit the **wheel bolt wrench** over the wheel bolt and push it down as far as it will go.
- Close your grip around the *end* of the wrench handle for maximum torque and turn each wheel bolt **clockwise** until it sits tight.

! WARNING

- Using force without control to speed the wheel change up can cause the vehicle to slip off the jack and cause serious personal injuries.
- *Do not* loosen the wheel bolts *more than one turn* before you raise the vehicle with the jack. - Risk of injury!

i Tips

- Never try and use the hexagonal socket in the handle of the screwdriver to loosen or tighten the wheel bolts.
- If a wheel bolt sits very tight, you may find it easier to loosen by carefully pushing down on the end of the wheel bolt wrench with *one foot only*. As you do, hold on to the car to keep yourself stable and take care not to slip. ■

Raising the vehicle

The vehicle must be lifted with the jack first before the wheel can be removed.

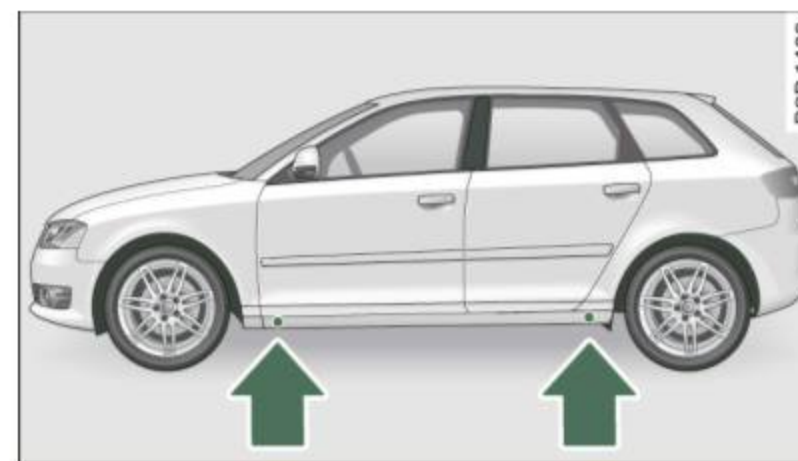

Fig. 189 Wheel change: mounting points for the lifting jack

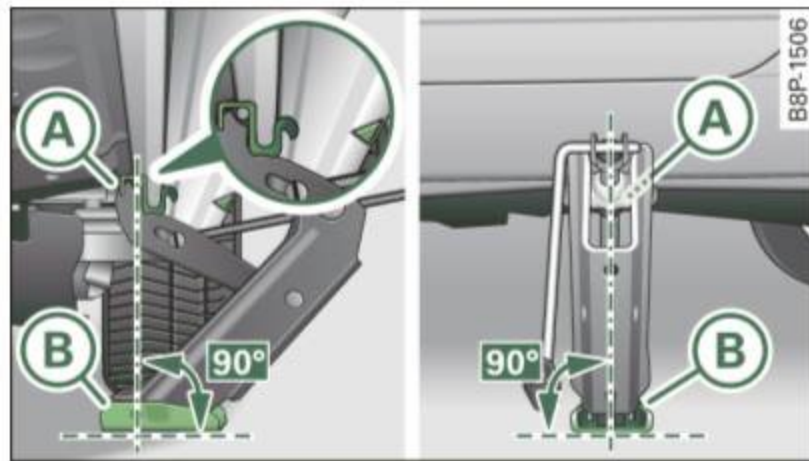

Fig. 190 Close-up:
proper positioning of
lifting jack

- Activate the **parking brake** so the vehicle will not roll unintentionally.
- Shift into **1st gear** on vehicles with manual transmission, or move the **selector lever to the P position** on vehicles with automatic transmission.
- Position the jack below the door sill under the **mounting point** that is closest to the wheel to be changed
⇒ page 276, fig. 189.
- Turn the **jack handle** clockwise until the jack arm just fits underneath the rib running along the underbody ⇒ ⚠.
- Align the jack so that the jack arm claw ⇒ fig. 190 (A) fits snugly around the underbody rib and the movable base plate (B) sits flat on the ground. The base (B) must be *vertical* under the lifting point (A).
- Wind the jack up further until the flat wheel comes off the ground ⇒ ⚠.

Recesses at the front and rear of the underbody rib mark the proper mounting locations for the jack ⇒ page 276, fig. 189. There is *only one* designated jack mounting point for each wheel. *Do not* apply the jack anywhere else ⇒ ⚠.

The jack should be positioned approximately 6 in. (15 cm) behind the front wheel or 10 in. (25 cm) in front of the rear wheel.

An **unstable surface** under the jack can cause the vehicle to slip off the jack. Always provide a firm base for the jack on the ground. If necessary place a sturdy board or similar support under the jack. On **hard, slippery surfaces** (such as tiles) use a rubber mat or similar to prevent the jack from slipping ⇒ ⚠.

⚠ WARNING

- You or your passengers could be injured while changing a wheel if you do not follow safety precautions:
 - Mounting the jack under the vehicle at any other place than indicated above may damage the vehicle or may result in personal injuries.
 - A soft or unstable surface under the jack may cause the vehicle to slip off the jack. Always provide a firm base for the jack on the ground. If necessary, use a sturdy board under the jack.
 - On hard, slippery surface (such as tiles) use a rubber mat or similar to prevent the jack from slipping.
- To help prevent injury to yourself and your passengers:
 - Do not raise the vehicle until you are sure the jack is securely engaged.
 - Passengers must not remain in the vehicle when it is jacked up.
 - Make sure that passengers wait in a safe place away from the vehicle and well away from the roadway and traffic.
 - Make sure jack position is correct, adjust as necessary and then continue to raise the jack. ■

Taking the wheel off/putting the spare on

Follow these instructions step-by-step for changing the wheel

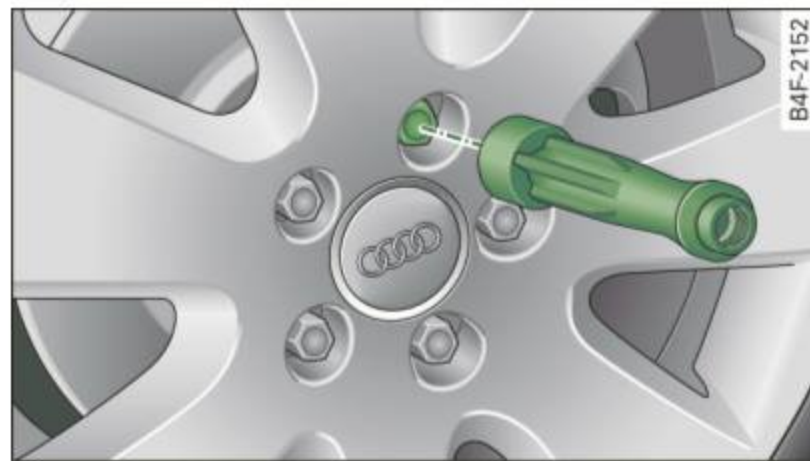

Fig. 191 Wheel change: using the screwdriver handle (with the blade removed) to turn the bolts



Fig. 192 Wheel change: alignment pin inside the top hole

After you have loosened all wheel bolts and jacked the vehicle off the ground, perform the following steps to remove and replace the wheel:

Removing the wheel

- Use the **hexagonal socket in the screwdriver handle** to completely turn out the topmost wheel bolt and set it aside on a *clean* surface ⇒ fig. 191.

- Screw the threaded end of the **alignment pin** from the tool kit hand-tight into the now vacant bolt hole ⇒ fig. 192.
- Then completely unscrew the other wheel bolts as described above.
- Take off the wheel leaving the alignment pin in the bolt hole ⇒ ⚠.

Putting on the spare

- Lift the spare wheel up and carefully slide it over the alignment pin to guide it in place.
- Use the hexagonal socket in the screwdriver handle to screw in and tighten all wheel bolts *slightly*.
- Unscrew the alignment pin and insert and tighten the remaining wheel bolt slightly like the rest.
- Turn the handle on the jack counter-clockwise to lower the vehicle until the jack is fully released.
- Use the wheel bolt wrench to tighten all wheel bolts firmly ⇒ *page 276*. Tighten them *crosswise*, from one bolt to the (approximately) opposite one, to keep the wheel centered.

⚠ WARNING

When removing or installing the wheel, the rim could hit the brake rotor and damage the rotor. Work carefully and have a second person help you.

i Tips

Never try and use the hexagonal socket in the handle of the screwdriver to loosen or tighten the wheel bolts. ▶

- Pull the reversible blade from the screwdriver before you use the hexagonal socket in the handle to turn the wheel bolts.
- When mounting tires with **unidirectional tread design** make sure the tread pattern is pointed the right way ⇒ *page 279*.
- The wheel bolts should be clean and easy to turn. Check for dirt and corrosion on the mating surfaces of both the wheel and the hub. Remove all dirt from these surfaces before remounting the wheel. ■

Tires with unidirectional tread design

Tires with unidirectional tread design must be mounted with their tread pattern pointed in the right direction.

Using a spare tire with a tread pattern intended for use in a specific direction

When using a spare tire with a tread pattern intended for use in a specific direction, please note the following:

- The direction of rotation is marked by an arrow on the side of the tire.
- If the spare tire has to be installed in the incorrect direction in the event of a flat tire, use the spare tire only temporarily since the tire will not be able to achieve its optimum performance characteristics with regard to aquaplaning, noise and wear.
- We recommend that particular attention be paid to this fact during wet weather and that you adjust your speed to match road conditions.
- Replace the flat tire with a new one and have it installed on your vehicle as soon as possible to restore the handling advantages of a properly pointed direction-dependent tire. ■

Notes on wheel change

Please read the information ⇒ *page 257*, “New tires and replacing tires and wheels” if you are going to use a spare tire which is different from the tires on your vehicle.

After you change a tire:

- Check the tire pressure on the spare immediately after mounting.
- Have the wheel bolt tightening torque checked with a torque wrench as soon as possible by your authorized Audi dealer or a qualified service station.
- On steel and alloy wheel rims, the wheel bolts are correctly tightened with a torque of 90 ft lb (120 Nm).
- If you notice while changing a tire that the wheel bolts are corroded and difficult to turn, then they should be replaced before you check the tightening torque.
- Replace the flat tire with a new one and have it installed on your vehicle as soon as possible. Remount the wheel cover.

Until then, drive with extra care and at reduced speeds.

WARNING

- If you are going to equip your vehicle with tires or rims which differ from those which were factory installed, then be sure to read the information ⇒ *page 257*, “New tires and replacing tires and wheels”.
- Always make sure the damaged wheel or even a flat tire and the jack and tool kit are properly secured in the luggage compartment and are not loose in the passenger compartment.
- In an accident or sudden maneuver they could fly forward, injuring anyone in the vehicle.
- Always store damaged wheel, jack and tools securely in luggage compartment. Otherwise, in an accident or sudden

 WARNING (continued)

maneuver they could fly forward, causing injury to passengers in the vehicle. ■

Fuses and bulbs

Electrical fuses

Replacing fuses

A problem in the electrical system may be caused by a blown fuse.



Fig. 193 Left cockpit:
fuse panel cover

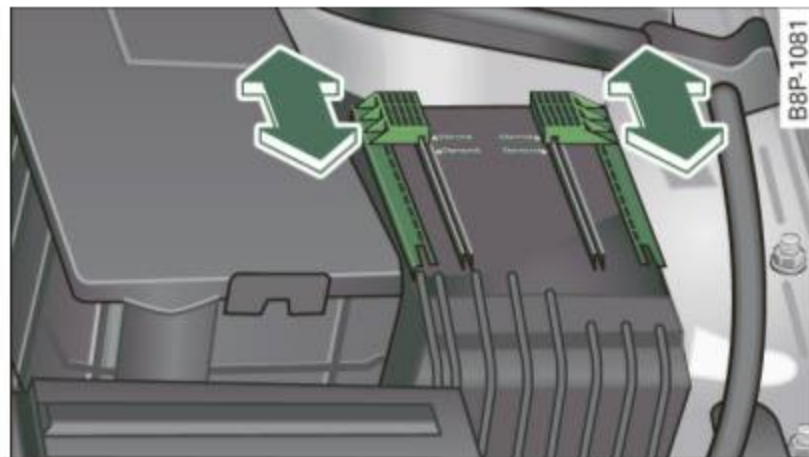

Fig. 194 Left side of
engine compartment:
fuse cover

Fuse cover on the left end face of the instrument panel

- Turn off the ignition and the affected electrical consumers.
- Carefully pry the fuse cover off the instrument panel using the ignition key or a screwdriver ⇒ fig. 193.
- Check the following table to see which fuse belongs to the consumer ⇒ *page 282*, "Fuse Location, Instrument Panel left".
- Remove the clamp from the rear side of the fuse cover ⇒ fig. 193.
- Remove the fuse using the clamp and replace the blown fuse with an identical new one.
- Firmly snap the cover back onto the instrument panel face.

Fuse cover in engine compartment

- Turn off the ignition and the affected electrical consumers.
- Check the following table to see which fuse belongs to the consumer ⇒ *page 284*, "Fuse location, left side of engine compartment".
- Unlatch the fuse cover, push the two slides forward ⇒ fig. 194.
- Remove the clamp from the rear side of the fuse cover ⇒ fig. 193.

- Remove the fuse using the clamp and replace the blown fuse with an identical new one.
- Push the two slides to the rear ⇒ *page 281*, fig. 194. Install the fuse cover carefully to prevent water from entering.

The various electrical circuits are protected by fuses. The fuses are clustered in a centralized unit. The unit is located behind the face panel at the end of the instrument panel. The crank for operating the sunroof in case of a power failure is also stored behind the face panel ⇒ *page 53*.

Two spare fuses and a sticker identifying the fuses are located on the inside of the fuse box cover.

You are well advised to keep a supply of spare fuses in your vehicle. Fuses with the proper ampere ratings are available at your authorized Audi dealer.

WARNING

Do not repair fuses and never replace a blown fuse with one that has a higher amp rating. This can cause damage to the electrical system and a fire.

Note

If a new fuse burns out again after shortly have you have installed it, have the electrical system checked by your authorized Audi dealer.

Tips

- The following table does not list fuse locations that are not used.
- Some of the equipment items listed are optional or only available on certain model configurations.
- The crank in the cover is used for emergency operation of the power roof*. ■

Fuse Location, Instrument Panel left

Fuses which can be replaced.

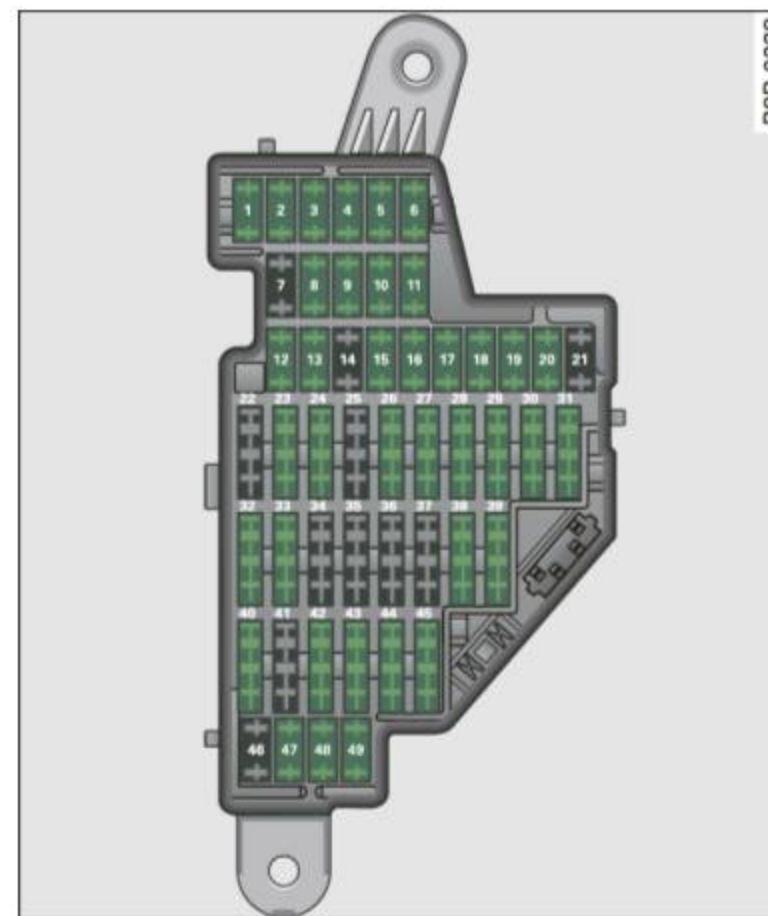

Fig. 195 Cockpit driver's side: fuse panel layout

Note that the following table is accurate at the time of going to press and is subject to change. In the event of discrepancies, the label on the inside of the cover always takes precedence.

The power seats are protected by **circuit breakers**, which automatically reset after a few seconds after the overload has been remedied. ►

No.	Equipment	Amps
1	Manual headlight beam adjustment, automatic headlight beam adjustment, AFS control module, engine components, light switch (switch lighting/illumination), diagnosis socket	10
2	Automatic transmission, control module for CAN data transfer (gateway), electro-mechanical steering, shift gate automatic transmission, engine relay, fuel tank control unit, engine control unit, brakes control (ABS), Electronic Stabilization Program (ESP), Anti-Slip Regulation (ASR)	10
3	Airbag	5
4	Air-conditioning (pressure sensor, air quality sensor), button for Electronic Stabilization Program (ESP), Anti-Slip Regulation (ASR), tire pressure monitor display, oil level sensor, back-up light switch, front seat heating, parking aid, seat-occupancy recognition (on USA vehicles), garage door opener, automatic mirror dimming, headlight assistant, heated windshield washer nozzles, air conditioning (control module)	5
5	AFS headlights (left side)	5
6	AFS headlights (right side)	5
9	Navigation system, radio system	15
10	digital radio, cell phone, TV equipment	7,5
11	Automatic mirror dimming, headlight assistant	10
12	Central locking (front doors)	10
13	Central locking (rear doors)	10
14	Electronic Stabilization Program (ESP) (control module), shift gate automatic transmission	10
15	Interior lights, reading lights	10

No.	Equipment	Amps
16	Diagnostic connector, rain sensor, air conditioning (control module), tire pressure monitor display (control module)	10
17	Anti-theft alarm warning system	5
18	Diagnose Starter	5
19	All Wheel Drive	10
22	Blower fan	40
23	Driver's side power window, front	30
24	Power outlet front	20
25	Rear window defogger	30
26	Power outlet in luggage compartment	20
27	Fuel tank control module, fuel pump	15
28	Power window, rear	30
33	Sliding/pop-up roof	20
36	Lumbar support	10
37	Heated seats, front	20
38	Passenger side power window, front	30
39	Special function interface	5
40	Starter	40
41	Rear window wiper	15
43	Body control module	20
47	Cell phone package (VDA interface)	5

Automatic circuit breakers:

The electric power windows and the electric seat adjusters are protected with circuit breakers which reset automatically after the circuit overload has been corrected. 

Tips

- Whenever replacing a fuse, always consult the sticker on the inside of the fuse panel cover. It contains the most up-to-date information regarding the fuse arrangement. If in doubt, ask your authorized Audi Service advisor.
- Some of the equipment items listed are optional or only available on certain model configurations. ■

Fuse location, left side of engine compartment

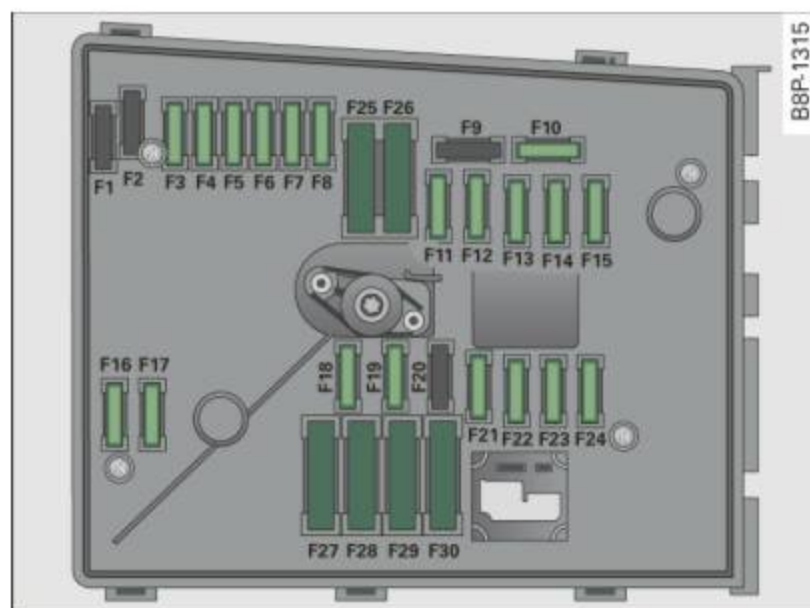

Fig. 196 Engine compartment: fuse assignment

Please check your car's fuse layout, there are two different layouts. Check the fuse layout with the fuse panel cover removed ⇒ *page 281*, "Fuse cover in engine compartment".

Some of the equipment items listed are optional or only available on certain model configurations.

Please note that the preceding table was accurate at the time of printing and is subject to change. In the event of discrepancies, the label on the inside of the cover always takes precedence.

No.	Equipment	Amps
F1	Terminal 30	40
F2	Engine components	20
F3	Battery voltage	5
F4	ESP valves, Anti-lock brake system (ABS) valves	20/30
F5	Transmission control module	15
F6	Steering wheel electronics	5
F10	Engine control module, main relay	5/10
F12	Control module for CAN data transfer (gateway)	5
F13	Engine control module	15/25/30
F14	Ignition coils, engine components (diesel engine)	20
F15	Preheating control module/engine component, tank diagnosis, oxygen sensor	5/10
F16	Body control module (right)	30
F17	Horn	15
F18	Audio amplifier	30
F19	Front windshield wiper system	30
F20	Water pump, volume regulator valve	10/20
F21	Oxygen sensor, vacuum pump	10/15
F22	Clutch pedal switch, brake light switch	5
F23	engine components, water pump	5/10/15
F24	Engine components, water pump	10
F25	Pump (ESP/ABS), ABS valve	40
F26	Body control module (left)	30

No.	Equipment	Amps
F27	Secondary air pump, preheating control module	40
F29	Fuse assignment in the left-side instrument panel (special equipment)	50
F30	Power supply relay terminal 15	50

Bulbs

Replacing light bulbs

For your safety, we recommend that you have your authorized Audi dealer replace burned out bulbs for you.

It is becoming increasingly more and more difficult to replace vehicle light bulbs since in many cases, other parts of the car must first be removed before you are able to get to the bulb. This applies especially to the light bulbs in the front of your car which you can only reach through the engine compartment.

Sheet metal and bulb holders can have sharp edges that can cause serious cuts, and parts must be correctly taken apart and then properly put back together to help prevent breakage of parts and long term damage from water that can enter housings that have not been properly resealed.

For your safety, we recommend that you have your authorized Audi dealer replace any bulbs for you, since your dealer has the proper tools, the correct bulbs and the expertise.

Gas discharge lamps (Xenon lights)*:

Due to the high electrical voltage, have the bulbs replaced by a qualified technician. Headlights with Xenon light can be identified by the high voltage sticker.

WARNING

Contact with high-voltage components of the electrical system and improper replacement of gas discharge (Xenon) headlight bulbs can cause serious personal injury and death.

- Xenon bulbs are pressurized and can explode when being changed.
- Changing Xenon lamps requires the special training, instructions and equipment.
- Only an authorized Audi dealer or other qualified workshop should change the bulbs in gas discharge lamps.

WARNING

There are parts with sharp edges on the openings and on the bulb holders that can cause serious cuts.

- If you are uncertain about what to do, have the work performed by an authorized Audi dealer or other qualified workshop. Serious personal injury may result from improperly performed work.

Tips

- If you must replace the light bulbs yourself, always remember that the engine compartment of any vehicle is a hazardous area to work in. Always read and heed all WARNINGS ⇒ page 218, “Engine compartment” ⇒ .
- It is best to ask your authorized Audi dealer whenever you need to change a bulb. ■

Emergency situations

General

This chapter is intended for trained emergency crews and working personnel who have the necessary tools and equipment to perform these operations. ■

Starting by pushing or towing



Note

Vehicles with an automatic transmission cannot be started by pushing or towing. ■

Starting with jumper cables

Jumper cable: Note the manufacturer's information.

If the battery is discharged, another vehicle can provide starting assistance. For this you require a jumper cable. Both batteries must have the same voltage (V) and a similar capacity (Ah).

Jumper cables

Use *only* jumper cables of sufficiently large **cross section** to safely carry the starter current. Refer to the manufacturer's specifications.

Use only jumper cables with *isolated* terminal clamps and properly marked for distinction:

plus (+) cable in most cases colored **red**

minus (-) cable in most cases colored **black**.

The wire cross section must be at least 0.038 in² (25 mm²) for gasoline engines and at least 0.054 in² (35 mm²) for diesel engines.



WARNING

Batteries contain electricity, acid, and gas. Any of these can cause very serious or fatal injury. Follow the instructions below for safe handling of your vehicle's battery.

- Always shield your eyes and avoid leaning over the battery whenever possible.
- A discharged battery can already freeze at temperatures just below 32 °F (0 °C). Never attempt to provide starting assistance on a frozen or thawed out battery – Danger of explosion and chemical burns! Replace a battery if it has been frozen.
- Do not allow battery acid to contact eyes or skin. Flush any contacted area with water immediately.
- Improper use of a booster battery to start a vehicle may cause an explosion.
- Vehicle batteries generate explosive gases. Keep sparks, flame and lighted cigarettes away from batteries.
- Do not try to jump start any vehicle with a low acid level in the battery.
- The voltage of the booster battery must also have a 12-Volt rating. The capacity (Ah) of the booster battery should not be lower than that of the discharged battery. Use of batteries of different voltage or substantially different “Ah” rating may cause an explosion and personal injury.
- Never charge a frozen battery. Gas trapped in the ice may cause an explosion.
- Never charge or use a battery that has been frozen. The battery case may have been weakened.
- Use of batteries of different voltage or substantially different capacity (Ah) rating may cause an explosion and injury. The capacity (Ah) of the booster battery should not be lower than that of the discharged battery.

⚠ WARNING (continued)

- Before you check anything in the engine compartment, always read and heed all WARNINGS ⇒ *page 218*, “Engine compartment”.

ⓘ Note

- Applying a higher voltage booster battery will cause expensive damage to sensitive electronic components, such as control units, relays, radio, etc.
- There must be no electrical contact between the vehicles as otherwise current could already start to flow as soon as the positive (+) terminals are connected.
- Improperly connected jumper cables can cause substantial damage to the electrical system of the vehicle.

ⓘ Tips

- The discharged battery must be properly connected to the vehicle's electrical system. ■

General information of starting assistance

Please observe that the procedure described below for connecting jumper cables is intended to provide a jump start for your vehicle.

Make sure that the connected clamps have sufficient *metal* contact. Start assistance differs for vehicles with a 4-cylinder engine: ⇒ *page 288*, “Use of jumper cables”

⚠ WARNING

Improper handling of the jumper cables can lead to an explosion of the battery and severe injuries. To reduce the risk of injury, note the following:

- The sections of the terminal clamps that are not insulated must not touch each other. In addition, the cable clamped to the battery's positive terminal must not come in contact with electrically connected parts of the vehicle - danger of short circuit!
- Route the jumper cable so that it cannot catch in any rotating parts in the engine compartment.
- Do not bend over the batteries - danger of chemical burns!
- The battery cell locking screws must be tightened securely.
- Keep ignition sources (open flame, burning cigarettes, etc.) away from the batteries - danger of explosion!
- Do not clamp the minus cable to parts of the fuel system or the brake lines.

ⓘ Note

If you provide start assistance for others with your vehicle, you should not clamp the minus cable (-) to the negative terminal of the discharged battery ⇒ *page 288*, fig. 197 ④ but to a solid metal part screwed firmly to the engine block, or to the engine block itself. In case of an inadequately ventilated battery of the vehicle receiving power, there is a danger of explosion due to detonating gas! ■

Use of jumper cables

Make sure to connect the jumper cable clamps in exactly the order described below!

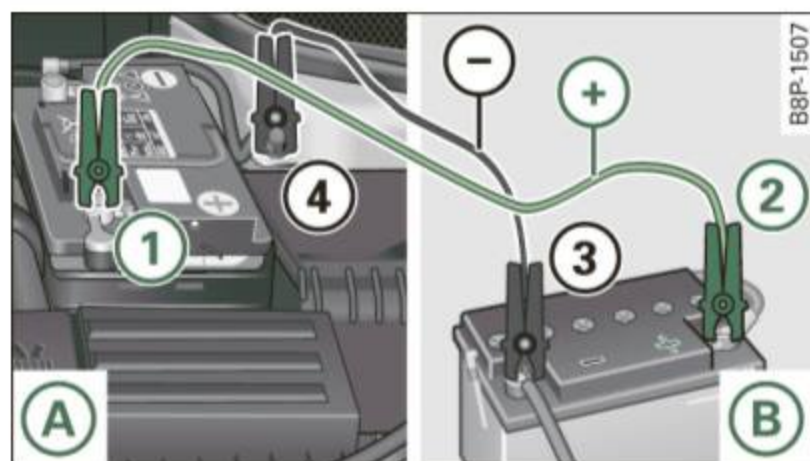

Fig. 197 Jump-starting with the battery of another vehicle: A - discharged vehicle battery, B - booster battery

The battery is located in the front, in the engine compartment on the driver's side. To reach the positive terminal, remove the cover ⇒ *page 239*.

Preparatory measures

1. Do not jump start a frozen battery! ⇒ ⚠ in "Starting with jumper cables" on *page 286*, ⇒ ⚠ in "General information of starting assistance" on *page 287*. Replace such a battery!
2. Otherwise apply the hand brake and shift into idle gear if your vehicle has manual transmission, and put the selector lever into P position if your vehicle has automatic transmission.
3. For both vehicles switch off all consumers and the ignition.

Connecting/disconnecting the jumper cable

4. Connect one end of the red jumper cable to the positive terminal (1) ⇒ fig. 197 of the discharged battery (A) ⇒ ⚠ in "General information of starting assistance" on *page 287*.
5. Connect the other end of the red jumper cable to the positive terminal (2) of the booster battery (B).
6. Connect one end of the black jumper cable, preferably at the ground point. Otherwise, connect it to the negative terminal (3) of the booster battery (B).
7. Connect the other end of the black jumper cable to the **ground point (bolt head) (4) in your vehicle (A)**.
8. Route the jumper cables so that they cannot catch in any rotating parts in the engine compartment.

Starting the engine

9. Start the engine of the vehicle providing assistance and allow it to run at idle.
10. Now start the engine of the vehicle with the discharged battery, wait for two to three minutes until the engine "runs" smoothly.
11. If the engine does not start: Stop trying after 10 seconds and then try again after about 30 seconds.
12. In the vehicle that has received start assistance, turn on the heater blower and the rear window heating to eliminate any voltage peaks when disconnecting. Driving lights must be switched off! ▶

13. Disconnect the cable while the engine is running exactly in *reverse* order to that described in \Rightarrow *page 288*, “Connecting/disconnecting the jumper cable”. When doing so, make sure that the cable cannot contact rotating engine parts.
14. Turn the heater blower and the rear window heating off again.

The battery is vented to the outside to prevent gases from entering the vehicle interior.

Make sure that the jumper clamps are well connected with their *metal parts in full contact* with the battery terminals.

WARNING

To avoid serious personal injury and damage to the vehicle, heed all warnings and instructions of the jumper cable manufacturer. If in doubt, call for road service.

- Jumper cables must be long enough so that the vehicles do not touch.
- When connecting jumper cables, make sure that they cannot get caught in any moving parts in the engine compartment.
- Before you check anything in the engine compartment, always read and heed all WARNINGS \Rightarrow *page 218*, “Engine compartment”.

Note

Improperly connected jumper cables can damage or destroy the generator.

- Do not use the battery negative terminal for jump starting or a malfunction could occur in the vehicle electrical system.
- Always connect POSITIVE (+) to POSITIVE (+), and NEGATIVE (-) to NEGATIVE (-) terminal.

- Check that all screw plugs on the battery cells are screwed in firmly. If not, tighten plugs prior to connecting clamp on negative battery terminal.
- Please note that the procedure for connecting a jumper cable as described above applies specifically to the case of your vehicle being jump started. When you are giving a jump start to another vehicle, do *not* connect the minus (-) cable to the minus (-) terminal on the discharged battery  \Rightarrow *page 288*, fig. 197. Instead, securely connect the minus (-) cable to either a massive metal component that is firmly bolted to the engine block or to the engine block itself. If the battery that is being charged does not vent to the outside, escaping battery gas could ignite and explode! ■

Emergency towing with commercial tow truck

General hints

Your Audi requires special handling for towing.

The following information is to be used by commercial tow truck operators who know how to operate their equipment safely.

- **Never tow your Audi, towing will cause damage to the engine and transmission.**
- **Never wrap the safety chains or winch cables around the brake lines.**
- **To prevent unnecessary damage, your Audi must be transported with a car carrier (flat bed truck).**
- **To load the vehicle on to the flat bed, use the towing loop found in the vehicle tools and attach to the front or rear anchorage \Rightarrow *page 290* and \Rightarrow *page 290*.**

WARNING

A vehicle being towed is not safe for passengers. Never allow anyone to ride in a vehicle being towed, for any reason. ■

Front towing loop

Do not install the front towing loop until it is needed.



Fig. 198 Front bumper: removing the cover cap



Fig. 199 Front bumper: screwing in the towing loop

The towing loop fits into the threaded hole located on the right side of the front bumper and covered by a small cover when not in use. Note that the towing loop has a **left-hand thread!**

- Remove the towing loop from the vehicle toolkit ⇒ *page 270*.
- Press on the *bottom* edge of the cover cap to disengage and take it out of the bumper. The cap remains connected to the bumper ⇒ fig. 198.
- Insert the towing loop into the threaded hole ⇒ fig. 199 and turn it all the way in until it is seated securely, then tighten it with the wheel bolt wrench.

When it is no longer needed, unscrew the towing loop and put it back into the on-board toolkit. Make sure to have the towing loop stored in the vehicle at all times.

WARNING

If the towing loop is not screwed in as far as it will go, the thread can pull out when the vehicle is towed - potential risk of an accident. ■

Rear towing loop

Do not install the rear towing loop until it is needed.



Fig. 200 Rear bumper: cover

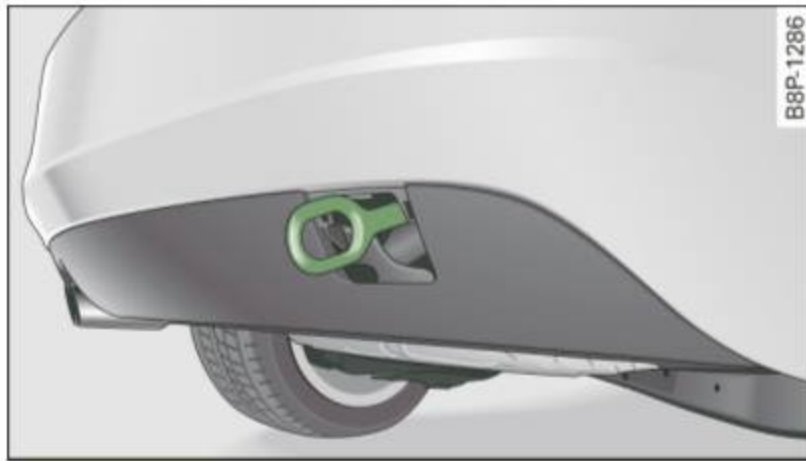

Fig. 201 Rear bumper: towing loop inserted

On the right side of the rear bumper there is a threaded hole for the towing loop. The threaded hole is behind a cover. Note that the towing loop has a **left-hand thread!**

- Remove the towing loop from the vehicle toolkit ⇒ *page 270*.
- Place the screwdriver against the upper edge of the cover and carefully pry it out ⇒ *page 290*, fig. 200.
- Insert the towing loop into the threaded hole ⇒ fig. 201 and turn it all the way in until it is seated securely, then tighten it with the wheel bolt wrench.

When it is no longer needed, unscrew the towing loop and put it back into the vehicle toolkit. Be sure to have the towing loop stored in the vehicle at all times.

WARNING

If you do not screw the towing loop completely, it could come out of the threaded hole while the vehicle is being towed causing damage to the vehicle and possible serious personal injury. ■

Loading the vehicle onto a flat bed truck

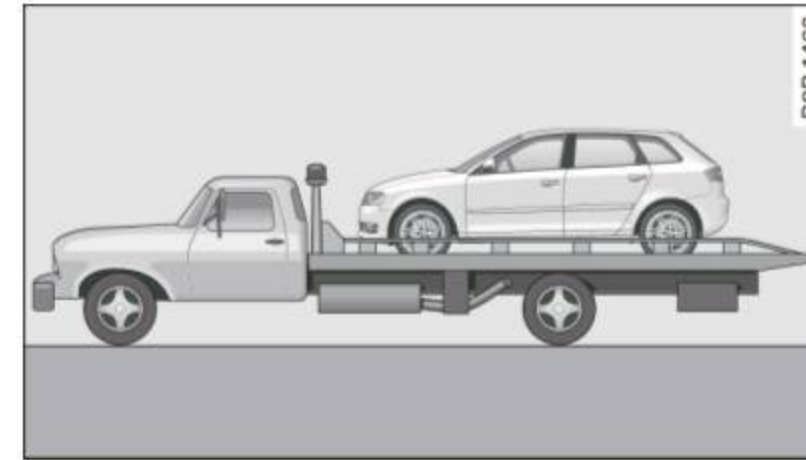

Fig. 202 Vehicle on flat bed truck

Front hook up

- Align the vehicle with the centerline of the car carrier ramp.
- Attach the winch hook to the front towline eye ⇒ *page 290*, fig. 199 previously installed.

Rear hook up

- Align the vehicle with the centerline of the car carrier ramp.
- Attach the winch hook to the rear towline eye ⇒ fig. 201 previously installed.

Tips

Check carefully to make sure the hook-up is secure before moving the car up the flatbed truck ramp. ■

Lifting the vehicle

Important safety precautions

Be aware of the following hazards before lifting the vehicle with a workshop hoist or floor jack:

- The vehicle should never be lifted or jacked up from underneath the engine oil pan, the transmission housing, the front or rear axle or the body side members. This could lead to serious damage.
- Use lifting equipment with padded contact surfaces to avoid damage to the underbody or chassis frame.
- Alternatively, cover the contact surfaces on workshop hoist or floor jack with rubber pads before lifting.
- Before driving over a workshop hoist, check that the vehicle weight does not exceed the permissible lifting capacity of the hoist.
- Before driving over a workshop hoist, ensure that there is sufficient clearance between the hoist and low parts of the vehicle.

WARNING

To reduce the risk of serious injury and vehicle damage:

- Always lift the vehicle only at the special workshop hoist and floor jack lift points illustrated ⇒ fig. 203 and ⇒ fig. 204.
- Failure to lift the vehicle at these points could cause the vehicle to tilt or fall from a lift if there is a change in vehicle weight distribution and balance. This might happen, for example, when heavy components such as the engine block or transmission are removed.
- When removing such heavy components, anchor vehicle to hoist or add corresponding weights to maintain the center of gravity. Otherwise, the vehicle might tilt or slip off the hoist, causing serious personal injury. ■

Lifting with workshop hoist and with floor jack

The vehicle may only be lifted at the lifting points illustrated.

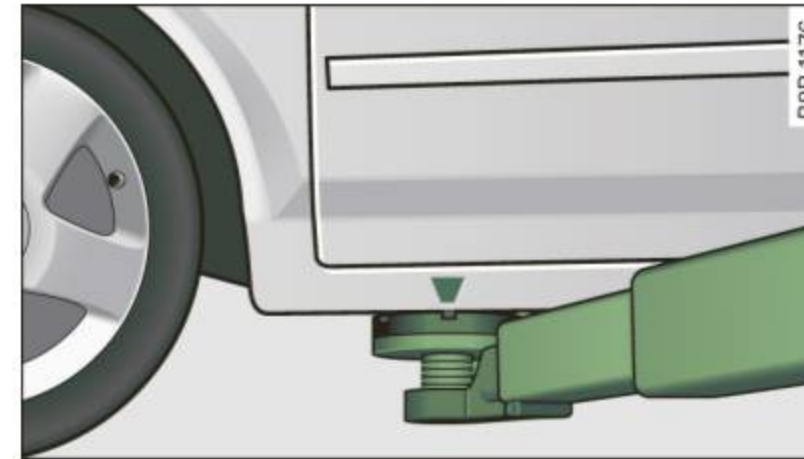

Fig. 203 Front lifting point

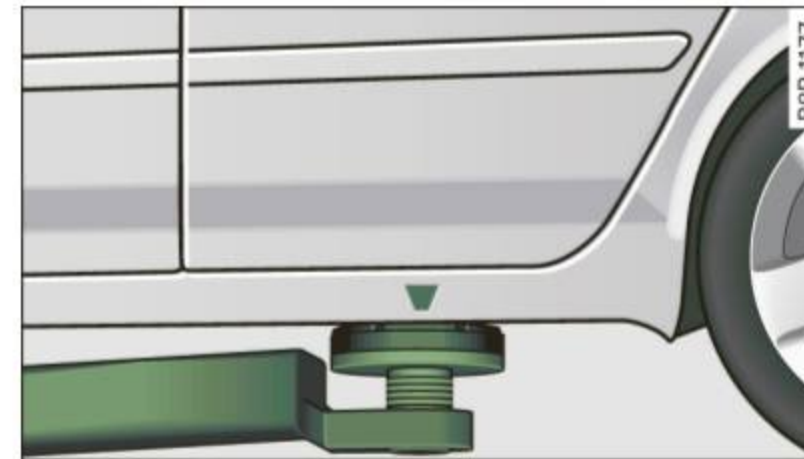



Fig. 204 Rear lifting point

- Read and heed WARNING ⇒  in “Important safety precautions”.
- Locate lifting points ⇒ fig. 203 ⇒ fig. 204.
- Adjust lifting arms of workshop hoist or floor jack to match vehicle lifting points.
- Insert a rubber pad between the floor jack/workshop hoist and the lifting points. ►

If you must lift your vehicle with a floor jack to work underneath, be sure the vehicle is safely supported on stands intended for this purpose.

Front lifting point

The lifting point is located on the floor pan reinforcement about at the same level as the jack mounting point ⇒ *page 292*, fig. 203. **Do not lift the vehicle at the vertical sill reinforcement.**

Rear lifting point

The lifting point is located on the vertical reinforcement of the lower sill for the onboard jack ⇒ *page 292*, fig. 204.

Lifting with vehicle jack

Refer to ⇒ *page 276*.



Note

- Be aware of the following points before lifting the vehicle:
 - The vehicle should never be lifted or jacked up from underneath the engine oil pan, the transmission housing, the front or rear axle or the body side members. This could lead to serious damage.
 - To avoid damage to the underbody or chassis frame, a rubber pad must be inserted between the floor jack and the lift points.
 - Before driving over a workshop hoist, check that the vehicle weight does not exceed the permissible lifting capacity of the hoist.
 - Before driving over a workshop hoist, ensure that there is sufficient clearance between the hoist and low parts of the vehicle. ■

General information

Explanation of technical data

Some of the technical data listed in this manual requires further explanation.

The technical data for your vehicle is listed in the charts starting on ⇒ page 296. This section provides general information, notes and restrictions which apply to this data. ■

Vehicle identification

The key data are given on the vehicle identification number (VIN) plate and the vehicle data sticker.



Fig. 205 Vehicle Identification Number (VIN) plate: location on driver's side dash panel

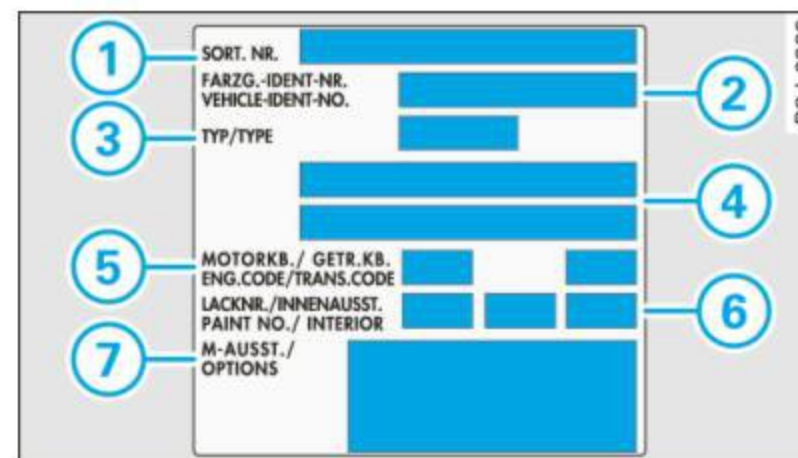

Fig. 206 The vehicle identification label – inside the luggage compartment

The Vehicle Identification Number (VIN)

is located on the driver's side so that it is visible from the outside through the windshield – see ⇒ fig. 205.

The vehicle identification label

is located in the luggage compartment in the spare wheel well.

The label ⇒ fig. 206 shows the following vehicle data:

- ① Production control no.
- ② Vehicle identification no.
- ③ Type code number
- ④ Type designation/engine output in Kilowatts
- ⑤ Engine and transmission code letter
- ⑥ Paint no./Interior
- ⑦ Optional equipment no.'s

Vehicle data 2 to 7 are also found in your Warranty & Maintenance booklet.

The safety compliance sticker

is your assurance that your new vehicle complies with all applicable Federal Motor Vehicle Safety Standards which were in effect at the time the vehicle was manufactured. You can find this sticker on the ►

left door jamb. It shows the month and year of production and the vehicle identification number of your vehicle (perforation) as well as the Gross Vehicle Weight Rating (GVWR) and the Gross Axle Weight Rating (GAWR).

The high voltage warning label

is located on the lock carrier.

The spark ignition system complies with the Canadian standard ICES-002. ■

Weights

Gross Vehicle Weight Rating

The Gross Vehicle Weight Rating (GVWR), and the Gross Axle Weight Rating (GAWR) for front and rear are listed on a sticker on the left door jamb.

The Gross Vehicle Weight Rating includes the weight of the basic vehicle plus full fuel tank, oil and coolant, plus maximum load, which includes passenger weight (150 lbs/68 kg per designated seating position) and luggage weight.

Gross Axle Weight Rating

The Gross Axle Weight Rating is the maximum load that can be applied at each axle of the vehicle ⇒ .

Vehicle capacity weight

The vehicle capacity weight (max. load) is listed either on the driver's side B-pillar or inside the fuel filler flap.

Roof weight

The maximum permissible roof weight is **165 lb (75 kg)**. The roof weight is made up of the weight of the roof rack system and the weight of the object being transported ⇒ *page 88*, "Loading the roof rack".

WARNING

- The actual Gross Axle Weight Rating at the front and rear axles should not exceed the permissible weights, and their combination must not exceed the Gross Vehicle Weight Rating.
- Exceeding permissible weight ratings can result in vehicle damage, accidents and personal injury.

Note

- The vehicle capacity weight figures apply when the load is distributed evenly in the vehicle (passengers and luggage). When transporting a heavy load in the luggage compartment, carry the load as near to the rear axle as possible so that the vehicle's handling is not impaired.
- Do not exceed the maximum permissible axle loads or the maximum gross vehicle weight. Always remember that the vehicle's handling will be affected by the extra load. Therefore, adjust your speed accordingly.
- Always observe local regulations. ■

Dimensions

The specifications refer to the basic model. Differences may occur depending on the model type and options ordered, for example, tire sizes.

Note

When driving up steep ramps, on rough roads, over curbs, etc. it is important to remember that some parts of your vehicle, such as spoilers or exhaust system components, may be close to the ground. Be careful not to damage them. ■

Data

Applies to vehicles: with 2.0 liter TFSI 4-cyl. gasoline engine,

200 hp, 2.0 liter 4-cyl. turbo gasoline engine

Engine data

Maximum output SAE net	hp @ rpm	200 @ 5100 - 6000
Maximum torque SAE net	lb-ft @ rpm	207 @ 1700 - 5000
No. of cylinders		4
Displacement	CID (cm ³)	121 (1984)
Stroke	in (mm)	3.65 (92.8)
Bore	in (mm)	3.25 (82.5)
Compression ratio		9.6 : 1
Fuel	Premium unleaded (91 AKI) Recommended for maximum engine performance. Further details ⇒ <i>page 219, "Gasoline"</i>	

Dimensions (approx.)

Length (with license plate bracket)	in (mm)	168.9 (4292)
Width (across mirrors)	in (mm)	78.5 (1995)
Height (unladen, incl. roof rails)	in (mm)	56.0 (1423)
Turning circle diameter (curb to curb)	ft. (m)	35.1 (10.7)

Capacities (approx.)

Fuel tank			
- Total capacity	front wheel drive	gal/liters	14.63 / 55.0
	all wheel drive	gal/liters	15.85 / 60.0

- Reserve (of total capacity)	gal/liters	1.8 / 7.0
Windshield washer fluid container	quarts/liters	3.1 / 3.0
Engine oil with filter change	quarts/liters	4.8 / 4.6

Applies to vehicles: with 2.0 liter TDI 4-cyl. clean diesel engine,

140 hp, 2.0 TDI liter 4-cyl. turbo clean diesel engine

Engine data

Maximum output SAE net	hp @ rpm	140 @ 4200
Maximum torque SAE net	lb-ft @ rpm	236 @ 1750 - 2500
No. of cylinders		4
Displacement	CID (cm ³)	120.1 (1968)
Stroke	in (mm)	3.76 (95.5)
Bore	in (mm)	3.19 (81.0)
Compression ratio		16.5 : 1
Fuel	ULSD Diesel No. 2 Further details ⇒ <i>page 220, "Diesel fuel"</i>	

Dimensions (approx.)

Length (with license plate bracket)	in (mm)	168.9 (4292)
Width (across mirrors)	in (mm)	78.5 (1995)
Height (unladen, incl. roof rails)	in (mm)	56.0 (1423)
Turning circle diameter (curb to curb)	ft. (m)	35.1 (10.7)

Capacities (approx.)

Fuel tank		
- Total capacity	gal/liters	14.63 / 55.0
- Reserve (of total capacity)	gal/liters	1.8 / 7.0
Windshield washer fluid container	quarts/liters	3.1 / 3.0
Engine oil with filter change	quarts/liters	4.2 / 4.0

Consumer Information

Warranty coverages

Your Audi is covered by the following warranties:

- *New Vehicle Limited Warranty*
- *Limited Warranty Against Corrosion Perforation*
- *Emissions Control System Warranty*
- *Emissions Performance Warranty*
- *California Emissions Control Warranty (USA vehicles only)*
- *California Emissions Performance Warranty (USA vehicles only)*

Detailed information regarding your warranties can be found in your **Warranty & Maintenance Booklet**. ■

Operating your vehicle outside the U.S.A. or Canada

Government regulations in the United States and Canada require that automobiles meet specific emission regulations and safety standards. Therefore, vehicles built for the U.S.A. and Canada differ from vehicles sold in other countries.

If you plan to take your vehicle outside the continental limits of the United States or Canada, there is the possibility that

- unleaded fuels for vehicles with catalytic converter may not be available;
- fuel may have a considerably lower octane rating. Improper fuel may cause engine damage;
- service may be inadequate due to lack of proper service facilities, tools or testing equipment;
- replacement parts may not be readily available.

- Navigation systems for vehicles built for the U.S.A. and Canada will not necessarily work in Europe, and may not work in other countries outside of North America.

Audi cannot be responsible for mechanical damage that could result from inadequate fuel, service or parts availability.



Note

Audi cannot be responsible for mechanical damage that could result from inadequate fuel, service or parts availability. ■

Audi Service Repair Manuals and Literature

Audi Official Factory Service Manuals and Literature are published as soon as possible after model introduction. Service manuals and literature are available to order from the Audi Technical Literature Ordering Center at:

www.audi.techliterature.com ■

Maintenance

General

Your vehicle has been designed to help keep maintenance requirements to a minimum.

However, a certain amount of regular maintenance is still necessary to assure your vehicle's safety, economy and reliability.

For detailed vehicle maintenance consult your Warranty & Maintenance booklet. ▶

Under difficult operating conditions, for example at extremely low outside temperatures, in very dusty regions, when towing a trailer very frequently, etc., some service work should be performed between the intervals specified. This applies particularly to:

- oil changes, and
- cleaning or replacing the air filter.



For the sake of the environment

By regularly maintaining your vehicle, you help make sure that emission standards are maintained, thus minimizing adverse effects on the environment. ■

Important considerations for you and your vehicle

The increasing use of electronics, sophisticated fuel injection and emission control systems, and the generally increasing technical complexity of today's automobiles, have steadily reduced the scope of maintenance and repairs which can be carried out by vehicle owners. **Also, safety and environmental** concerns place very strict limits on the nature of repairs and adjustments to engine and transmission parts which an owner can perform.

Maintenance, adjustments and repairs usually require special tools, testing devices and other equipment available to specially trained workshop personnel in order to assure proper performance, reliability and safety of the vehicle and its many systems.



Improper maintenance, adjustments and repairs can impair the operation and reliability of your vehicle and even void your vehicle warranty. Therefore, proof of servicing in accordance with the maintenance schedule may be a condition for upholding a possible warranty claim made within the warranty period.

Above all, operational safety can be adversely affected, creating unnecessary risks for you and your passengers.

If in doubt about any servicing, have it done by your authorized Audi dealer or any other properly equipped and qualified workshop. We strongly urge you to give your authorized Audi dealer the opportunity to perform all scheduled maintenance and necessary repairs. Your dealer has the facilities, original parts and trained specialists to keep your vehicle running properly.

Performing limited maintenance yourself

The following pages describe a limited number of procedures which can be performed on your vehicle with ordinary tools, should the need arise and trained personnel be unavailable. Before performing any of these procedures, always thoroughly read all of the applicable text and carefully follow the instructions given. Always rigorously observe the **WARNINGS** provided.

Before you check anything in the engine compartment, always read and heed all WARNINGS ⇒  and ⇒  in "Working in the engine compartment" on page 226.



WARNING

- **Serious personal injury may occur as a result of improperly performed maintenance, adjustments or repairs.**
- **Always be extremely careful when working on the vehicle. Always follow commonly accepted safety practices and general common sense. Never risk personal injury.**
- **Do not attempt any of the maintenance, checks or repairs described on the following pages if you are not fully familiar with these or other procedures with respect to the vehicle, or are uncertain how to proceed.**
- **Do not do any work without the proper tools and equipment. Have the necessary work done by your authorized Audi dealer or another properly equipped and qualified workshop.**
- **The engine compartment of any motor vehicle is a potentially hazardous area. Never reach into the area around or touch the radiator fan. It is temperature controlled and can switch on suddenly - even when the engine is off and the ignition key has**

⚠ WARNING (continued)

been removed. The radiator fan switches on automatically when the coolant reaches a certain temperature and will continue to run until the coolant temperature drops.

- Always remove the ignition key before anyone gets under the vehicle.
- Always support your vehicle with safety stands if it is necessary to work underneath the vehicle. The jack supplied with the vehicle is not adequate for this purpose and could collapse causing serious personal injury.
- If you must work underneath the vehicle with the wheels on the ground, always make sure the vehicle is on level ground, that the wheels are always securely blocked and that the engine cannot be started.
- Always make sure the transmission selector lever (automatic transmission) is in "P" (Park position) (automatic transmission) or Neutral (manual transmission) and the hand brake is firmly applied.

**For the sake of the environment**

- Changing the engine settings will adversely affect emission levels. This is detrimental to the environment and increases fuel consumption.
- Always observe environmental regulations when disposing of old engine oil, used brake fluid, dirty engine coolant, spent batteries or worn out tires.
- Undeployed airbag modules and pretensioners might be classified as Perchlorate Material -special handling may apply, see www.dtsc.ca.gov/hazardouswaste/perchlorate. When the vehicle or parts of the restraint system including airbag modules safety belts with pretensioners are scrapped, all applicable laws and regulations must be observed. Your authorized Audi dealer is familiar with these requirements and we recommend that you have your dealer perform this service for you. ■

Additional accessories, modifications and parts replacement

Additional accessories and parts replacement

Always consult an authorized Audi dealer before purchasing accessories.

Your vehicle incorporates the latest safety design features ensuring a high standard of active and passive safety.

This safety could be compromised by non-approved changes to the vehicle. For this reason, if parts have to be replaced, please observe the following points when installing additional accessories:

Approved Audi accessories and genuine Audi parts are available from authorized Audi dealers.

These dealers also have the necessary facilities, tools and trained specialists to install the parts and accessories properly.

⚠ WARNING

Using the wrong spare parts non-approved accessories can cause damage to the vehicle and serious personal injury.

- Use only accessories expressly approved by Audi and genuine Audi spare parts
- These parts and accessories have been specially designed to be used on your vehicle.
- Never install accessories such as telephone cradles or beverage holders on airbag covers or within the airbag deployment zones. Doing so will increase the risk of injury if airbags are triggered in an accident!
- Before you check anything in the engine compartment, always read and heed all WARNINGS ⇒ page 218.

Note

- If items other than genuine Audi spare parts, add-on equipment and accessory items are used or if repair work is not performed according to specified methods, this can result in severe damage to your vehicle's engine and body (such as corrosion) and adversely affect your vehicle's warranty.
- If emergency repairs must be performed elsewhere, have the vehicle examined by an authorized Audi dealership as soon as possible.
- The manufacturer cannot be held liable for damage which occurs due to failure to comply with these stipulations. ■

Installing/replacing a sound system

If you wish to install a radio or replace the factory installed radio, please note the following:

The factory installed radio connectors are designed for genuine Audi radios. When installing a different radio, difficulties could arise such as:

- the radio may not fit into the space provided
- the electrical connections may not be compatible
- different connector terminals may be needed.

Therefore, we recommend that you have your authorized Audi dealer install or replace the radio.

They are the most familiar with the technical features of your vehicle. They also offer Genuine Audi Radios with the necessary installation components and instructions.

WARNING

Improperly installing a radio could cause a short circuit and an electrical fire. ■

Technical Modifications

Our guidelines must be complied with when technical modifications are made.

Always consult an authorized Audi dealer **before** starting work on any modifications.

This will help ensure that vehicle function, performance and safety are not impaired ⇒ .

Attempting to work on electronic components and the software used with them can cause malfunctions. Because of the way electronic components are interconnected with each other, such malfunctions can also have an adverse affect on other systems that are not directly involved. This means that you risk both a substantial reduction in the operational safety of your vehicle and an increased wear of vehicle parts ⇒ .

Authorized Audi dealers will perform this work in a professional and competent manner or, in special cases, refer you to a professional company that specializes in such modifications.

WARNING

Improper repairs and modifications can change the way vehicle systems work and cause serious personal injury.

Note

If emergency repairs must be performed elsewhere, have the vehicle examined by an authorized Audi dealership as soon as possible. ■

Declaration of Compliance, Telecommunications and Electronic Systems

Radio Frequency Devices and Radiocommunication Equipment User Manual Notice.

The manufacturer is not responsible for any radio or TV interference caused by unauthorized modifications to this equipment.

Devices

The following devices each comply with FCC Part 15.19, FCC Part 15.21 and RSS-Gen Issue 1:

- Cell phone package
- Electronic immobilizer
- HomeLink® universal remote control
- Remote control key
- Tire pressure monitoring system*

FCC Part 15.19

This device complies with part 15 of the FCC Rules. Operation is subject to the following two conditions:

- (1) This device may not cause harmful interference, and
- (2) this device must accept any interference received, including interference that may cause undesired operation.

FCC Part 15.21

CAUTION:

Changes or modifications not expressly approved by the party responsible for compliance could void the user's authority to operate the equipment.

RSS-Gen Issue 1

Operation is subject to the following two conditions:

- (1) this device may not cause interference, and

- (2) this device must accept any interference, including interference that may cause undesired operation of the device. ■

- A**
- ABS
 See Anti-lock brake system 192
- AC (air conditioner) 97
- Accessories 301
- Adapter for anti-theft wheel bolts 275
- Adding
 Engine coolant 236
 Engine oil 232
 Windshield washer fluid 243
- Additional accessories 301
- Additional heater
 Climate controls 102
- Additives
 Engine oil 232
- Adjustable steering wheel column 105
- Adjusting
 Steering wheel column 105
- Adjusting front seats 73
- Advanced Airbag System
 Components 152
 Front airbags 150
 How the components work together . 153
 Monitoring 156
 PASSENGER AIR BAG OFF light 157
- Air conditioner 97
 See *also* Climate controls 95
- Air conditioning
 Switching on and off 97
- Air distribution
 Climate controls 100
- Air outlets
 Adjusting the outlets for rapid
 defrosting/defogging 101
 Climate controls 101
- Air quality sensor 99
- Air recirculation 100
 Climate controls 99
 When should I use the air recirculation? . .
 99
- Air recirculation mode
 Climate controls 99
- Airbag
 Warning/indicator lights 15
- Airbag System
 Weight-sensing mat 168
- Airbag system 145, 162
 Advanced Airbag System 149
 Care 159
 Child restraints 169
 Children 168
 Components (front airbags) 152
 Danger of fitting a child safety seat on the
 front passenger seat 147
 Disposal 159
 Front airbags 149
 How do the front airbags work? 154
 How many airbags does my vehicle have? .
 152
 Important things to know 145
 Indicator light 156
 Monitoring 156
 Repairs 159
 Side airbags 161
- Side curtain airbags 164
 When must the system be inspected? 156
- All Wheel Drive 194
- Alloy wheels 212
- All-wheel drive
 Winter tires 261
- Alternator
 See Generator 15
- Aluminum alloy wheels 212
- Ambient lighting 62
- Anti-glare inside day-night mirror 63, 64
- Anti-lock brake system
 How the ABS system works 192
 Warning/indicator lights 16
- Anti-Slip Regulation System (ASR)
 How the system works 190
- Anti-theft systems
 Anti-Theft Alarm System 48
- Anti-theft wheel bolts 275
- Armrest
 Center armrest 79
 Rear armrest 80
- ASR
 How the Anti-Slip Regulation System
 works 190
- Asterisk
 What does it mean when something is
 marked with an asterisk? 5
- Audi magnetic ride 12, 112
 Description 112
 Indicator light 12

Audi Service Repair Manuals and Literature 299

AUTO

- Climate controls 98
- Switching on 98
- When should I use AUTO? 98

Auto Safety Hotline 133

Automatic air recirculation 99

Automatic belt retractor 139

Automatic car wash

- See Washing 207

Automatic headlights

- defective 36

Automatic Transmission

- Automatic Transmission 118

Automatic transmission 115

- Driving Notes 117
- Emergency program 121
- Emergency release 121
- Ignition key safety lock 106
- Kick-down 120
- Launch Control Program 120
- Selector lever lock 116
- Selector lever positions 115
- Tiptronic 119
- Tiptronic controls on the steering wheel 120

Average fuel mileage 21

Average speed 21

Avoid damaging the vehicle 199

B

Battery 238

- charging 241
- Disconnecting and connecting 238
- Important warnings when working on the battery 239
- Low 194
- Replacing the battery 242
- State of charge 194
- Winter operation 239
- Working on the battery 239

Battery voltage 35

Before driving 125

Bioethanol

- Engine preheater 103

Blended gasoline 219

Body cavity sealing 212

Booster seats 175

Brake assistant 193

Brake booster 192

Brake fluid

- Changing the brake fluid 238
- Checking the brake fluid level 237
- Reservoir 237
- What is the correct brake fluid level? 237
- What should I do if the brake fluid warning light comes on? 237

Brake pads 197

Brake system 237

- Anti-lock brake system 16
- Brake fluid 237

- Brake fluid specifications for refill and replacement 238
- Brake light defective 36
- General information 191
- How does moisture or road salt affect the brakes? 191
- Malfunction 32
- Warning/indicator lights 15
- Worn brake pads symbol 35

Break-in period 197

- Brake pads 197
- Tires 197

Bulbs 285

C

California Proposition 65 Warning 227

- Battery specific 241

Capacities 296

Car care 206

- Interior 213
- Plastic and vinyl 210
- Weatherstrips 211

Care of exterior 206

Cargo area

- See Loading the luggage compartment 131

Cargo net 83

Catalytic converter 198

Center armrest 79

Centigrade

- Switching between Centigrade and Fahrenheit 99

- Central locking
 - panoramic sliding sunroof closing 52
- Certification 303
- Changing a flat tire 272
- Changing engine oil 232
- Chassis
 - Undercoating 213
 - See also* Audi magnetic ride 112
- Checking
 - Engine coolant level 235
- Checking tire pressure 252
- Child restraint
 - Danger of using child restraints in the front seat 147
- Child restraint system anchors 180
- Child restraints
 - Where can I get additional information about child restraints and their use? . . . 186
- Child safety 167, 172
 - Convertible locking retractor 177
 - Important safety instructions for using child safety seats 170
 - Important things to know when driving with children 167
 - Installing a child restraint using the LATCH system 183
 - Mounting and releasing the anchorage hook 183
 - Tether anchors 184
 - Tether straps 184
- Child safety lock 47
- Child safety seats 172
 - Booster seats 175
 - Convertible child seats 173
 - Convertible locking retractor 177
 - How do I properly install a child safety seat in my vehicle? 170
 - Infant seats 172
 - Installing 177
 - LATCH system 183
 - Safety instructions 170
- Child seats
 - Lower anchorages 182
- Cleaning
 - Alcantara (synthetic suede) 217
 - Engine compartment 218
 - Exhaust tail pipes 213
 - Fabrics and fabric coverings 213
 - Instrument panel 214
 - Interior 213
 - Leather 216
 - Plastic and vinyl 210
 - Plastic parts 214
 - Safety belts 217
 - Trim strips 209
 - trim strips 210
- Cleaning and protection 206
- Climate controls 95
 - Additional heater 102
 - Air distribution 100
 - Air outlets 101
 - Air recirculation 100
 - Air recirculation mode (manual) 99
 - AUTO (standard setting) 98
 - Automatic air recirculation 99
- Controls 97
 - Defrosting/defogging 98
 - Description 95
 - Fan 100
 - Key-coded setting 102
 - Recommended settings 95
 - Setting the temperature 98
 - Switching between Fahrenheit and Centigrade 99
 - Switching the air conditioning on and off . . . 97
 - Using the climate control economically . . . 101
 - Warm and cold 95
- Clock 9
- Clutch pedal
 - Indicator light 33
- Coat hooks 94
- Cold tire inflation pressure 249
- coming home 57
- Compartments in the door trims 93
- Compass mirror 71
- Compliance 303
- Consumer Information 133, 299
- Contacting NHTSA 133
- Convenience close/open feature
 - Windows 50
- Convertible child safety seats 173
- Convertible locking retractor
 - Activating 179
 - Deactivating 180
 - Using to secure a child safety seat . . . 177, 179

- Coolant system 234
 - Cooling System
 - Expansion tank 235
 - Cruise control 110
 - Changing speed 111
 - Presetting your speed 111
 - Switching off 112
 - Switching on 110
 - Warning/indicator lights 14
 - Cup holder 89
 - Cup holders
 - front 89
 - Current fuel mileage 21
- D**
- Damping
 - See Audi magnetic ride 112
 - Data 296
 - Data recorder 188
 - Date display 9
 - Daytime running lights 56
 - Daytime running lights (Canada) 56
 - Declaration of compliance
 - Cell phone package 303
 - Electronic immobilizer 303
 - HomeLink® universal remote control . 303
 - Remote control key 303
 - Tire pressure monitoring system 303
 - def
 - What does this mean when it appears in the trip odometer display? 10
 - Defective light bulb warning 36
 - Defogging the windows 98
 - Defrosting the windows 98
 - Defrosting/defogging windows 101
 - Determining correct load limit 254
 - Diesel engine
 - Adding engine oil 233
 - Changing engine oil 233
 - Engine oil 233
 - Diesel fuel 220
 - Diesel particulate filter 34, 199
 - Digital clock 9
 - Setting the time 9
 - Digital compass 71
 - Dimensions 295
 - Dipstick
 - Reading the dipstick properly 231
 - Direct Shift Gearbox
 - Emergency release 121
 - Distance 22
 - Doors, power locks 43
 - Driver information 31
 - Driver Information System
 - Menu display 22
 - Driver information system
 - Gearshift indicator 19
 - Menu button 24
 - Open door or front lid warning 18
 - Outside temperature display 18
 - Red symbols 30
 - Service interval display 27
 - Setting 25
 - Sound system display 18
 - Trip computer 21
 - yellow symbols 30
 - Driver seat
 - See Seating position 126
 - Driving safely 124
 - Driving through water 198
 - Duplicate key 38
- E**
- Efficiency program 25
 - Fuel economy messages 26
 - Other equipment 26
 - Elapsed time 21
 - Electrically heated front seats 103
 - Electro-mechanical power assist ... 17, 193
 - Electronic differential lock (EDL)
 - How the system works 189
 - Warning/indicator lights 16
 - Electronic immobilizer 10, 40
 - Electronic power control
 - EPC warning/indicator light 13
 - Electronic speed limiter 20
 - Electronic Stability Program 188
 - Electronic stabilization program (ESP)
 - Warning/indicator lights 14
 - Emergency flasher
 - Warning/indicator lights 14
 - Emergency flashers 59
 - Emergency operation
 - panoramic sliding sunroof 53
 - Rear lid 46

- Emergency release for selector lever . . . 121
 - Emergency starting 286
 - Emergency towing 289
 - Energy management 194
 - Battery power 196
 - Driver notification 196
 - Engine
 - 4-cylinder diesel (140 hp) 228
 - 4-cylinder gasoline (200 hp) 227
 - Coolant 234
 - Hood 225
 - Preheater 103
 - Starting 106, 107
 - Starting with jumper cables 286
 - Stopping 108
 - Engine compartment 227
 - Safety instructions 226
 - Working in the engine compartment 226
 - Engine coolant system 234
 - Adding coolant 236
 - Checking coolant level 235
 - Checking the engine coolant level . . . 235
 - Radiator fan 237
 - Engine coolant temperature
 - Gauge 9
 - Engine cooling system
 - Malfunction 32
 - Engine data 296
 - Engine fault
 - Warning light 13
 - Engine hood
 - Closing 226
 - Release lever 225
 - Releasing and opening 225
 - Engine malfunction (diesel engine)
 - Warning light 13
 - Engine oil 228
 - Adding 232
 - Additives 232
 - Changing 232
 - Checking the engine oil level 231
 - Diesel engine 233
 - Indications and conditions requiring extra checking 231
 - Oil consumption 230
 - Oil grades 228
 - Recommended oil check intervals . . . 231
 - Specification and viscosity 228
 - Specifications Diesel engine 233
 - Specifications gasoline engine 228
 - Engine oil level 34
 - Engine oil pressure (malfunction) 33
 - Engine oil sensor defective 35
 - Engine preheater 103
 - Connecting 103
 - Engine speed limitation 34
 - Environment
 - Break-in period 197
 - Catalytic converter 198
 - Diesel particulate filter 199
 - Disposing of your vehicle battery 242
 - Driving at high speeds 200
 - Driving to minimize pollution and noise . . 200
 - Fuel 222
 - Fuel economy 200
 - Leaks under your vehicle 226
 - Letting the vehicle stand and warm up . . . 200
 - Proper disposal of drained brake fluid 238
 - Proper disposal of drained engine coolant 236
 - Proper disposal of drained engine oil 232
 - Recycling used engine oil 232
 - Unleaded fuel 219
 - What should I do with an old battery? . . . 242
- EPC**
- See Electronic power control 13
- ESP**
- See Electronic Stability Program 188
- Event Data Recorder (EDR) 188**
- Exhaust tail pipes**
- Cleaning 213
- Expansion tank 235**
- F**
- Fahrenheit**
- Switching between Fahrenheit and Centigrade 99
- Fan**
- Adjusting the fan speed 100
 - Climate controls 100
 - Radiator 237

Fastening		Fuel economy messages (efficiency program)		Tachometer	8
Booster seats	175	26		Trip odometer	10
Convertible child safety seats	173	Fuel filler flap		Gear recommendation	19
Infant seats	172	Unlocking the fuel filler flap by hand	224	Gearshift indicator	19
Fastening eyes	82	Fuel gauge	10	Gearshift lever	114
Flat tire		Fuel range	21	General illustration	
Changing	272	Fuel supply		Instruments and controls	7
Floor mats	130	Additives	219	Generator	
Fog lights, front	58	Blended gasoline	219	Warning/indicator lights	15
Folding master key with remote control	38	Fuel filler neck	221	Glossary of tire and loading terminology	246
Foot pedals	130	Fuel gauge	10	Glove compartment	92
For the sake of the environment		Fuel tank capacity	10, 221	Light	60, 61
Gasoline fumes and the environment	222	Gasoline	219	Glow plug system	
Letting your engine warm up	107	Gasoline additives	220	Indicator light	13
Reducing engine noise by upshifting early	8, 9	Octane rating	219	Warning light	13
Refueling	222	Recommendation	219	Gross Vehicle Weight Rating (GVWR)	295
Saving fuel by upshifting early	8, 9	Refuelling	222		
Using the rear window defogger	102	Unlocking the fuel filler flap by hand	224	H	
Front airbags		Fuel tank		Head restraints	128
Description	149	Capacity	221	Adjusting	128
How they work	154	Capacity (gallons/liters)	10	Rear seats	78
Front seats	73	Fuse arrangement	282	Headlight	
Adjusting	127	Fuses		defective	36
Adjusting the manual seats	74	Replacing	281	Headlight range control	
Child restraints in the front seat	147	G		defective	35
Heated seats	103	Gas discharge lamps	285	Headlights	56
Frontal collisions and the laws of physics	136	Gauges		Front fog lights	58
Fuel		Engine coolant temperature	9	Switching off	56
Current fuel mileage	21	Fuel gauge	10	Switching on	56
Fuel gauge	10	Speedometer	10	Xenon headlights	56
Fuel supply too low	34			Heated	
				rear window	102

- Heated outside mirrors 65
 Heated washer jets
 Wiper and washer system 65
 Heavy clothing and safety belts 138
 High beam 56, 59
 Warning/indicator lights 14
 High voltage warning label 294
 Hill Descent Assist 118
 Hill hold assist
 Starting on hills 110
 hood
 See Engine hood 225
 Hood release 225
 Horn 7
 How are child restraint system anchors related
 to child safety 180
 How many airbags does my vehicle have?
 152
 How often should I check my tire pressures? .
 253
 How safety belt pretensioners work 143
 Hydroplaning 257
- I**
- Ignition key 106
 Ignition lock 106
 Ignition lock positions 106
 Immobilizer 10
 Important information for vehicles with Diesel
 engine when adding or changing engine
 oil 233
 Important things to do before driving .. 125
- Improperly worn safety belts 143
 Indicator light
 Airbag system 156, 157
 Audi magnetic ride 12
 PASSENGER AIR BAG OFF 157
 Indicator lights 8, 11
 Red symbols in the center display 30
 Yellow symbols in the center display .. 30
 Infant seats 172
 Inside rear view mirror 63, 64
 Installing child safety seats
 Safety belts 177
 Installing the upper tether strap on the
 anchorage 185
 Instrument panel
 Illumination 58
 Instrument panel and controls 8
 Instruments and controls
 General illustration 7
 Interior light
 Rear 62
 Interior lights 60, 61
 Ambient lighting 62
 Luggage compartment 63
 Interlock switch 33
- J**
- Jack and tools 270
 Jump starting 288
 Jumper cables 288
 Jump-starting 286
- K**
- Key 38
 Battery replacement 40
 Coded settings 102
 Convenience opening and closing of
 windows 50
 Key replacement 38
 Master key 38
 Valet key 38
 Key-coded settings
 Climate controls 102
 Kick-down
 Automatic transmission 120
- L**
- LATCH 180
 Description 182
 Installing a child restraint 183
 Location 181
 Mounting and releasing the anchorage
 hook 183
 Launch Control Program 120
 Leather 215
 Cleaning 216
 leaving home 57
 Lifting jack 276
 Lifting points 292
 Lifting/raising the vehicle 292
 Light
 coming/leaving home 57
 Exterior lighting 57

Light/rain sensor defective 36

Lights 56

- Emergency flasher 59
- Front fog lights 58
- Headlights 56
- High beam 56, 59
- High beam warning/indicator light ... 14
- Instrument panel illumination 58
- Side marker lights 56
- Turn signals 59
- Xenon headlights 56

Loading the luggage compartment 131

Loading the roof rack 88

Locking

- Manual back-up 47
- Power locking switch 44
- Rear lid 45
- Remote control 42
- Using the fold-out key 43

Lower universal anchorage bars (Canada) ... 180

Lower universal anchorages (Canada) ... 180

Luggage

- Stowing 131

Luggage compartment

- Cargo net 83
- Fastening eyes 82
- Increasing size 81
- Light 63
- Retractable cover 84
- Ski sack 85
- See also Loading the luggage compartment 131

Lumbar support 77

M

Maintenance 299

Malfunction Indicator Lamp (MIL) ... 14, 20

Manual transmission 114

- Gearshift lever 114

Master key 39

- Battery replacement 40

Master key remote control 39

Menu button 24

Menu display

- Driver Information Display 22

Mirrors

- Activating the digital compass 71
- Adjusting the anti-glare 63, 64
- Automatically dimming inside mirror . 64
- Inside day-night mirror 63
- Interior mirror 63, 64
- Outside mirrors 65

Monitoring the Advanced Airbag System 156

Mounting hooks 83

N

Natural leather 215

New tires and wheels 257

NHTSA

- Contacting 133

Number of seats 135

O

Occupant seating positions 126

Octane rating 219

Odometer 10

Oil

- What kind of oil should I put in my engine? 228
- See also Engine oil 228

On-Board Diagnostic System 20

- Electronic speed limiter 20
- Malfunction Indicator Lamp (MIL) ... 20

On-Board Diagnostic System (OBD) 20

- Data Link Connector (DLC) 20

Open door or front lid warning 18

Operate your vehicle economically and minimize pollution 200

Optional equipment

- Marked with an asterisk 5

Other equipment (efficiency program) ... 26

Outlets 90

Outside air pollution

- How to prevent from entering the vehicle 100

Outside mirrors 65

Outside temperature display 18

Owner's manual

- How the Owner's Manual is organized .. 5

P

Paint

- Touch-up 210

- Paint no 294
- panoramic sliding sunroof 51
- Comfort closing 52
- Emergency operation 53, 54
- to close 51
- to open 51
- Parking 109
- Automatic transmission 117
- Parking brake 108
- Setting and releasing 108
- Parking brake warning 32
- Parking on a decline (downhill) 109
- Parking on an incline (uphill) 109
- Particle filter
- See Diesel particulate filter 34
- Parts replacement 301
- PASSENGER AIR BAG OFF light 157
- Passive safety system 124
- Pedals 130
- Physical principles of a frontal collision . 136
- Polishing 209
- Power locking switch 44
- Rear center console 45
- Power locking system 40
- Convenience close/open feature 50
- Locking and unlocking the vehicle from
 inside 44
- Opening and closing the windows 50
- Operating locks from with key 43
- Rear lid 45
- Remote control 39, 42
- Unlocking and locking vehicle 42
- Power outlets 90
- Power seat
- Adjusting the seatback 76
- Adjustment 75
- Power steering
- See Electro-mechanical power assist . 17,
 193
- Power sunroof
- See panoramic sliding sunroof 51
- Power window switches 49
- In the driver's door 49
- Reactivating the system 51
- Pregnant women
- Special considerations when wearing a
 safety belt 141
- Proper occupant seating positions 126
- Proper safety belt position 140
- Proper seating position
- Front passenger 127
- Occupants 126
- Rear passengers 128
- Q**
- Quartz clock 9
- quattro®
- See All Wheel Drive 194
- Question
- What happens to unbelted occupants? ...
 137
- Why safety belts? 135
- R**
- Radiator fan 237
- Radio
- Replacing 302
- Rain sensor defective 36
- Reading light
- Rear 62
- Reading lights
- Front 60, 61
- Rear 60, 61
- Rear armrest 80
- Rear lid
- Emergency release 46
- Locking/unlocking 45
- Rear light defective 36
- Rear power locking switch 45
- Rear seat bottom 81
- Rear view mirror
- Inside rear view mirror 63, 64
- Rear window defogger
- with air-conditioning 102
- Refuelling 222
- Release lever for engine hood 225
- Remote control 39
- Resetting remote control 43
- Unlocking and locking 42
- Remote master key
- Battery replacement 39
- Check light 39
- Repair manuals 299
- Repairs
- Airbag system 159
- Replacing
- Wheel rims 257

- Replacing a sound system 302
 - Replacing light bulbs 285
 - Replacing tires and wheels 258
 - Replacing windshield wiper blades 69
 - Reporting Safety Defects 133
 - Reset button 10
 - Resetting remote control 43
 - Retractor 139
 - Reverse
 - Automatic transmission 115
 - Rims
 - Cast alloy 212
 - Replacing 257
 - Steel rims 212
 - Roof rack
 - Attachment points with separate roof rack system 87
 - Loading 88
 - Mounting locations 88
 - Safe mounting 86
 - Roof weight 88
- S**
- S tronic 115
 - Driving Notes 117
 - Emergency program 121
 - Kick-down 120
 - Launch Control Program 120
 - Selector lever lock 116
 - Selector lever positions 115
 - Tiptronic 119
 - Tiptronic controls on the steering wheel . . . 120
 - SAFE 10
 - Safe driving habits 124
 - Safety belt position 140
 - Safety belt height adjustment 142
 - Safety belts worn by pregnant women . . . 141
 - Safety belt pretensioner 143
 - Service and disposal 144
 - Safety belt warning light 15, 135
 - Safety belts 139
 - cleaning 217
 - Danger to passengers who do not wear a safety belt 137
 - Fastening 139
 - height adjustment 142
 - Improperly worn 143
 - Not worn 137
 - Safety belt position 140
 - Safety instructions 138
 - Securing child safety seats 177
 - Special considerations for pregnant women 141
 - Unfastening 142
 - Warning/indicator light 135
 - Why YOU MUST wear them . . . 135, 136
 - Worn properly 138
 - Safety compliance sticker 294
 - Safety equipment 124
 - Safety features for occupant restraint and protection 124
 - Safety guidelines
 - Seat adjustment 73
 - Safety instructions
 - Engine compartment 226
 - for side curtain airbags 166
 - for using child safety seats 170
 - for using safety belts 138
 - Monitoring the Advanced Airbag System . . . 158
 - Safety lock
 - Ignition key, automatic transmission 106
 - Seat adjustment
 - Driver's seat 73
 - Front passenger's seat 74
 - Front seats 73
 - Head restraints 128
 - Head restraints, front seat 77
 - Lumbar support 77
 - Manual controls 74
 - Manual seats 74
 - Power seat 75
 - Seat belts
 - Why YOU MUST wear them . . . 135, 136
 - See also* Safety belts 135
 - Seating capacity 135
 - Seating position
 - Driver 126
 - Front passenger 127
 - How to adjust the front seats 127
 - Incorrect seat position 129
 - Occupants 126
 - Rear passengers 128

- Seats
 - Number of seats 135
 - Selector lever positions
 - Automatic transmission 115
 - Service and disposal
 - Safety belt pretensioner 144
 - Service interval display 27
 - Service position for windshield wipers ... 68
 - Set menu 25
 - Setting
 - Date display 9
 - Digital clock 9
 - Side airbags
 - Description 161
 - How they work 162
 - Side curtain airbags 164
 - Description 164
 - How they work 165
 - Safety instructions 166
 - Side marker lights 56
 - Ski sack 85
 - Snow chains 262
 - Sockets 90
 - Sound system
 - Replacing 302
 - Sound system display 18
 - Sources of information about child restraints
and their use 186
 - Spare tire 271
 - Spare wheel
 - See Spare tire 271
 - Speed rating letter code 259
 - Speed warning 35
 - Speed warning system 28
 - Speedometer 10
 - Starting assistance 288
 - Starting on hills
 - Hill hold assist 110
 - Starting the engine 106, 107
 - What should I do if the engine does not
start? 107
 - Steel wheels 212
 - Steering 105
 - Locking the steering 106
 - See also Electro-mechanical power assist .
17, 193
 - Steering wheel column
 - Adjusting 105
 - Steps for determining correct load limit 254
 - Stopping the engine 108
 - Storage 91
 - Compartments in the door trims 93
 - Cup holder rear center armrest 89
 - Glove compartment 92
 - Small objects 92
 - Storage compartment
 - Increasing size 81
 - Sun visors 63
 - Sunroof
 - See panoramic sliding sunroof 51
 - Switches
 - Emergency flasher 59
 - Switching the air conditioner (automatic)
on/off 97
 - Symbols
 - Red symbols in the center display 30
 - Yellow symbols in the center display .. 30
- ## T
- Tachometer 8
 - Tailgate
 - See Rear lid 45
 - Technical modifications 302
 - Temperature
 - Climate controls 98
 - Setting for the driver's and front passen-
ger's side 98
 - Tether anchors 184
 - Tether strap 184
 - The first 1,000 miles (1,500 km) and
afterwards 197
 - Tie-downs 82, 132
 - Tips for the environment
 - Saving fuel 89
 - Tire pressure 252
 - Tire pressure monitoring system 264
 - Loss of air pressure 13, 265
 - Malfunction 265
 - Resetting tire pressures 267
 - Warning light 36
 - Tire service life 256
 - Tires 245
 - Replacing 257
 - Service life 256
 - speed rating letter code 259
 - Tire manufacturing date 259

Tire specifications	258	Transmission		Vehicle Identification Number (VIN)	294
Tread depth	256	6-speed	114	Vehicle jack	270, 276
Uniform tire quality grading	260	Manual transmission	114	Vehicle literature	4
Winter tires	261	S tronic transmission	115	Vehicle-care products	206
Tires and vehicle load limits	253	Transport Canada	133		
Tires and wheels		Tread Wear Indicator (TWI)	256	W	
Checking tire pressure	252	Trip computer	21	Warning light	
Cold tire inflation pressure	249	Trip odometer	10	Tire pressure monitoring system	36
Dimensions	257	What does it mean when dEF appears in the trip odometer display?	10	Warning lights	8, 11
General notes	245	Turn signals	59	Red symbols in the center display	30
Glossary of tire and loading terminology . 246		Warning/indicator lights	14	Yellow symbols in the center display . .	30
New tires and wheels	257			Warning/indicator lights	
Replacing	258	U		Airbag system	15
Snow chains	262	Undercoating	213	Anti-lock brake system (ABS)	16
Tires and vehicle load limits	253	Unfastening safety belts	142	Brake system	15
Wheel bolts	263	Unidirectional tires	245	Cruise control	14
Winter tires	261	Uniform tire quality grading	260	Electronic power control	13
Tires/Wheels		Unlocking		Electronic stabilization program (ESP) .	14
Low aspect ratio tires	264	Power locking switch	44	Engine malfunction (diesel engine) . . .	13
Tire pressure monitoring system	13, 264	Rear lid	45	Generator	15
Torn or frayed safety belts	138	Remote control	42	Glow plug system	13
Touch-up paint	210	Using the fold-out key	43	High beam	14
Towing				Malfunction Indicator Lamp (MIL)	14
Front eyelet	290	V		Parking brake	15
Rear eyelet	290	Vanity mirror	63	Safety belt	15
Tow truck procedures	289	Vehicle battery		Tire pressure monitoring system	13
TPMS		Stationary	239	Turn signals	14
Tire pressure monitoring system	265	Vehicle electrical system	15	Warranty coverages	299
Trailer towing	202	Vehicle identification	294	Washer reservoir	243
Operating instructions	203	Vehicle identification label	294	Washing	206
Technical requirements	202, 203			Automatic car wash	207
Trailer towing tips	204			by hand	207

- General information 206
 - with a power washer 208
 - Waxing 209
 - Wear indicator 256
 - Weatherstrips 211
 - Weights 295
 - What happens if you wear your safety belt too loose? 140
 - What happens to unbelted occupants? . 137
 - What impairs driving safety? 125
 - What should I do after changing a wheel? ... 253
 - What should I do after replacing wheels? ... 253
 - Wheel bolts
 - Anti-theft wheel bolts 275
 - Torque 263
 - Wheel change 272
 - Wheels 245
 - Checking tire pressure 252
 - Cold tire inflation pressure 249
 - General notes 245
 - Glossary of tire and loading terminology . 246
 - New tires and wheels 257
 - Tires and vehicle load limits 253
 - Wheels/Tires
 - Cast alloy 212
 - Steel wheels 212
 - When must a safety belt be replaced? .. 138
 - When must the airbag system be inspected? . 156
 - When should I adjust the tire pressures? 253
 - When should I check the tire pressures? 253
 - Where are lower anchorages located? .. 182
 - Where can I find the tire pressures for my car? 252
 - Why safety belts? 135
 - Windows
 - Cleaning 211
 - Convenience close/open feature 50
 - Defogging 98
 - Defrosting 98
 - Rapid defrosting/defogging 101
 - Windshield washer container 243
 - Windshield washer fluid 35
 - Windshield wipers
 - Changing the rear wiper blade 70
 - Installing new wiper blades 69
 - Service position 68
 - Winter operation
 - Battery 239
 - Coolant system 234
 - Tires 194
 - Windows 211
 - Winter tires 261
 - All-wheel drive 261
 - Wiper and washer system 65
 - Intermittent wiping 65
 - One-tap wiping 65
 - Rear window wiper 67
 - Wiper blades
 - Installing new wiper blades 69
 - See also* Windshield wipers 70
- X
- Xenon-Lights 285

It has always been Audi's policy to continuously improve its products. Audi, therefore, reserves the right to make changes in design and specifications, and to make additions or improvements in its products, without incurring any obligation to install them on products previously manufactured.

Text, illustrations and specifications in this manual are based on the most up-to-date information available at the time of printing.

All rights reserved. May not be reproduced or translated in whole or in part without the written consent of AUDI AG. Specifications are subject to change without notice.

"Audi", "quattro" and the four rings emblem are registered trademarks of AUDI AG. "A3" is trademark of AUDI AG.

Editorial deadline: 04/16/2010



For the sake of the environment

Printed on environmentally friendly paper (bleached without chlorine, recyclable).

Printed in Germany

© 2010 AUDI AG

www.audi.com

2011 Audi A3
Owner's Manual
Englisch USA 05.2010
111.561.8PA.23