



Mercedes-Benz

# M-Class

## Operator's Manual

## Symbols

Registered trademarks:

- AdBlue® is a registered trademark of the Association of German Automobile Manufacturers (VDA).
- BabySmart™ is a registered trademark of the Siemens Automotive Corp.
- Bluetooth® is a registered trademark of the Bluetooth SIG Inc.
- ESP® and PRE-SAFE® are registered trademarks of Daimler AG.
- HomeLink® is a registered trademark of Prince, a Johnson Controls Company.
- SIRIUS and related brands are registered trademarks of SIRIUS XM Radio Inc.

In this Operator's Manual you will find the following symbols:

### **Warning**

Warning notices draw your attention to hazards that endanger your health or life, or the health or life of others.

 Warning notices draw your attention to hazards that could cause damage to your vehicle.

 Practical tips or other information that could be helpful to you.

▶ This symbol indicates instructions that you must follow.

▶ A number of these symbols appearing in succession indicates instructions with several steps.

▷ page This symbol tells you where to look for further information on a topic.

▷▷ This symbol marks a warning or procedure which is continued on the next page.

Display Text in the multifunction display/COMAND display.

## **Welcome to the world of Mercedes-Benz**

Before you drive off, please familiarize yourself with your vehicle and read this manual, especially the safety and warning notices. This will help you to obtain the maximum pleasure from your vehicle and to avoid endangering yourself and others.

The equipment or product designation of your vehicle may vary depending on:

- model
- order
- country specification
- availability

Mercedes-Benz is constantly updating its vehicles to the state of the art.

Mercedes-Benz therefore reserves the right to introduce changes in the following areas:

- design
- equipment
- technical features

You cannot therefore base any claims on the data, illustrations or descriptions contained in this manual.

The following are integral parts of the vehicle:

- Operator's Manual
- Brief Instructions<sup>1</sup>
- Service Booklet
- Supplements relating to vehicle equipment

Keep these documents in the vehicle at all times. When you sell the vehicle, always pass the documents on to the new owner.

The technical documentation team at Daimler AG wishes you safe and pleasant motoring.

Mercedes-Benz USA, LLC

Mercedes-Benz Canada, Inc.

A Daimler Company

<sup>1</sup> Canada only.



---

**Index** ..... 4

---

**Introduction** ..... 19

**At a glance** ..... 25

---

**Safety** ..... 35

---

**Opening and closing** ..... 71

---

**Seats, steering wheel and mirrors** .... 91

---

**Lights and windshield wipers** ..... 105

---

**Climate control** ..... 121

---

**Driving and parking** ..... 137

---

**On-board computer and displays** .... 203

---

**Loading, stowing and features** ..... 255

---

**Maintenance and care** ..... 281

---

**Roadside assistance** ..... 295

---

**Tires and wheels** ..... 323

---

**Technical data** ..... 353

- 1, 2, 3 ...**
- 115 V socket** ..... 269
- 12 V socket** ..... 268
- 4ETS**  
see ETS/4ETS
- 4MATIC (permanent four-wheel drive)** ..... 191
- A**
- ABS (Anti-lock Braking System)**  
Display message ..... 228  
Function/notes ..... 65  
Warning lamp ..... 249
- Accident (notes)** ..... 297
- Active light function (display message)** ..... 233
- Active service system**  
see Service interval display
- Adaptive Damping System (ADS)** ..... 184
- AdBlue®**  
Adding ..... 156  
Display message ..... 236
- Additional functions (on-board computer)** ..... 219
- ADS (Adaptive Damping System)** ..... 184
- Air bags**  
Display message ..... 225  
Front air bag (driver, front passenger) ..... 39  
Important safety information ..... 38  
PASSENGER AIRBAG OFF indicator lamp (only Canada) ..... 48  
PASSENGER AIRBAG OFF indicator lamp (only USA) ..... 42  
Safety guidelines ..... 37  
Side impact air bag ..... 40  
Window curtain air bag ..... 41
- Air-conditioning system**  
see Climate control
- Air dehumidification**  
Activating/deactivating with cooling ..... 129
- Air distribution**  
Setting ..... 132
- Air filter (display message)** ..... 236
- Airflow**  
Setting ..... 132
- AIRMATIC package** ..... 183
- Air nozzles**  
see Air vents ..... 135
- Air pressure**  
see Tire pressure
- Air-recirculation mode**  
Activating/deactivating ..... 133
- Air vents** ..... 135  
Important safety information ..... 134  
Rear ..... 135  
Setting the center air vents ..... 135  
Setting the side air vents ..... 135
- Alarm system**  
see ATA
- Ambient lighting (on-board computer)** ..... 216
- AMG menu (on-board computer)** ..... 209
- Anti-lock Braking System**  
see ABS
- Anti-Theft Alarm system**  
see ATA
- Anti-theft system**  
ATA (Anti-Theft Alarm system) ..... 69
- Approach/departure angle** ..... 170
- Ashtray** ..... 267
- ATA (Anti-Theft Alarm system)**  
Activating/deactivating ..... 69  
Function ..... 69  
Switching off the alarm ..... 69
- Audio menu (on-board computer)** ..... 211
- AUTO lights**  
see Light sensor
- Automatic car wash** ..... 288
- Automatic transmission**  
DIRECT SELECT lever ..... 144  
Display message ..... 243  
Driving tips ..... 147  
Emergency running mode ..... 151  
Kickdown ..... 147  
Malfunction ..... 151  
Program selector button ..... 147  
Pulling away ..... 141  
Starting ..... 141  
Trailer towing ..... 147

- B**
- BAS (Brake Assist System)** ..... 66
- Battery**
- Charging ..... 314
  - Checking (SmartKey) ..... 76
  - Display message ..... 235
  - Important safety guidelines (SmartKey) ..... 75
  - Jump-starting ..... 315
  - Replacing (SmartKey) ..... 76
  - Safety notes ..... 312
  - Voltage (on-board computer) ..... 209
- Belt**
- see Seat belts
- Blind Spot Assist**
- Activating/deactivating (on-board computer) ..... 219
  - Display message ..... 239
  - Function/notes ..... 189
  - Trailer towing ..... 191
- BlueTEC**
- AdBlue® ..... 360
  - Adding AdBlue® ..... 156
- Brake fluid**
- Notes ..... 362
- Brake fluid level** ..... 286
- Brake lamp (display message)** ..... 231
- Brakes**
- ABS ..... 65
  - BAS ..... 66
  - Brake fluid (notes) ..... 362
  - Display message ..... 229
  - High-performance brake system .... 163
  - Maintenance ..... 162
  - Parking brake ..... 159, 163
  - Warning lamp ..... 247
- Braking**
- Important safety instructions ..... 161
- Breakdown**
- see Accident (notes)
  - see Flat tire
- Bulbs**
- Backup lamp ..... 115
  - Brake lamp ..... 115
  - High-beam headlamps ..... 113
  - License plate lamp ..... 116
  - Low-beam headlamps ..... 113
  - Overview ..... 112
  - Parking lamps ..... 114
  - Rear fog lamp ..... 115
  - Replacing ..... 114
  - Standing lamps (front) ..... 114
  - Standing lamps (rear) ..... 115
  - Tail lamps ..... 115
  - Turn signal lamp ..... 115
  - Turn signals (front) ..... 114
- C**
- CAC**
- (Customer Assistance Center) ..... 22
- California**
- Important notice for retail customers and lessees ..... 20
- Calling up a malfunction**
- see Display messages
- Care**
- Carpets ..... 293
  - Car wash ..... 288
  - Display ..... 292
  - Gear or selector lever ..... 292
  - Headlamps ..... 291
  - Notes ..... 288
  - Paint ..... 290
  - Plastic trim ..... 292
  - Power washer ..... 289
  - Rear view camera ..... 291
  - Roof lining ..... 293
  - Seat belt ..... 293
  - Seat covers ..... 292
  - Sensors ..... 291
  - Steering wheel ..... 292
  - Tail pipes ..... 291
  - Trim strips ..... 292
  - Washing by hand ..... 289
  - Wheels ..... 289
  - Windows ..... 290
  - Wiper blades ..... 290
  - Wooden trim ..... 292
- Cargo compartment cover** ..... 261
- Cargo compartment enlargement** ... 258
- Cargo compartment floor** ..... 298
- Cargo net**
- Attaching ..... 262
  - Important safety information ..... 261

- Cargo tie down rings** ..... 260
- CD player/CD changer (on-board computer)** ..... 212
- Center console** ..... 31
- Central locking**
  - Automatic locking (on-board computer) ..... 217
  - SmartKey ..... 72
- Changing bulbs**
  - Headlamps ..... 111
- Changing gears** ..... 146
- Changing the programming**
  - SmartKey ..... 75
- Checklist**
  - After driving off-road ..... 168
  - Before driving off-road ..... 167
- Child-proof locks**
  - Rear doors ..... 63
  - Special seat belt retractor ..... 61
- Children**
  - In the vehicle ..... 58
  - Restraint systems ..... 59
- Child seat**
  - Automatic recognition ..... 48
  - Automatic recognition/air bag deactivation, self-test ..... 50
  - ISOFIX (LATCH-type child seat anchors) ..... 61
  - Special seat belt retractor ..... 61
  - Top Tether ..... 62
  - Troubleshooting ..... 51
- Cigarette lighter** ..... 267
- Climate control**
  - Activating/deactivating ..... 128
  - Activating/deactivating air-recirculation mode ..... 133
  - Controlling automatically ..... 130
  - Cooling with air dehumidification .. 129
  - Defrosting the windshield ..... 132
  - Demisting the windows ..... 133
  - Dual-zone automatic climate control ..... 123
  - Important safety information ..... 122
  - Indicator lamp ..... 130
  - Multi-zone automatic climate control ..... 124
  - Problems with "cooling with air dehumidification" ..... 130
  - Problems with the rear window heating ..... 133
  - Rear control panel ..... 125, 128
  - Refrigerant ..... 362
  - Setting the air distribution ..... 132
  - Setting the airflow ..... 132
  - Setting the air vents ..... 135
  - Setting the temperature ..... 131
  - Setting the temperature (rear compartment) ..... 131
  - Switching the MONO function on/off ..... 132
  - Switching the rear window heating on/off ..... 133
  - Switching the residual heat function on/off ..... 134
- Clock (on-board computer)** ..... 215
- Cockpit** ..... 27
- Collapsible spare wheel**
  - Inflating ..... 309
  - see Emergency spare wheel
- Combination switch** ..... 109
- Compass** ..... 279
  - Calling up ..... 279
- Consumption statistics (on-board computer)** ..... 219
- Convenience closing feature** ..... 86
- Convenience opening feature** ..... 86
- Coolant (engine)**
  - Checking the level ..... 285
  - Display message ..... 233
  - Notes ..... 362
  - Temperature gauge ..... 208
- Cooling**
  - see Climate control
- Cornering light (display message) ...** 230
- Crash-responsive emergency lighting** ..... 111
- Cruise control** ..... 171
  - Cruise control lever ..... 172
  - Display message ..... 239
- Cup holder** ..... 265
  - Center console ..... 265
  - Rear compartment ..... 266
- Current fuel consumption (on-board computer)** ..... 220

- Customer Assistance Center**  
(CAC) ..... 22
- Customer Relations Department** ..... 22
- D**
- Dashboard**  
see Cockpit
- Date (on-board computer)** ..... 215
- Daytime driving lights**  
Display message ..... 233  
Switching on/off (on-board computer) ..... 215
- Delayed switch-off**  
Exterior lighting (on-board computer) ..... 216  
Interior lighting (on-board computer) ..... 217
- Diesel particle filter** ..... 161
- Differential locks** ..... 196
- Differential locks (display message)** ..... 238
- Digital speedometer**  
Displaying ..... 208  
Setting the unit (on-board computer) ..... 214
- DIRECT SELECT lever**  
see Automatic transmission
- Display (cleaning instructions)** ..... 292
- Display messages**  
Brakes ..... 228  
Calling up (on-board computer) ..... 222  
Clearing (on-board computer) ..... 222  
Engine ..... 233  
Lamps ..... 233  
Safety systems ..... 223  
Service interval display ..... 287  
Tires ..... 241  
Vehicle ..... 243
- Distance recorder** ..... 208
- Distance warning function (vehicles with DISTRONIC)** ..... 69  
Activating/deactivating (on-board computer) ..... 219
- Distance warning lamp** ..... 253
- DISTRONIC** ..... 173  
Display message ..... 240
- Displays in the multifunction display ..... 179
- Driving tips ..... 179
- Setting the specified minimum distance ..... 177
- Warning lamp ..... 253
- Door**  
Automatic locking ..... 79  
Automatic locking (on-board computer) ..... 217  
Display message ..... 244  
Emergency locking ..... 80  
Emergency unlocking ..... 80  
Opening (from inside) ..... 79
- Door control panel**  
Overview ..... 33
- Doors**  
Important safety notes ..... 78
- Drinking and driving** ..... 160
- Drinks holder**  
see Cup holder
- Drive program**  
Automatic ..... 148  
Manual ..... 149
- Driving abroad** ..... 171
- Driving in mountainous terrain**  
Approach/departure angle ..... 170
- Driving on flooded roads** ..... 164
- Driving safety system**  
EBD (Electronic Brake force Distribution) ..... 68  
ESP® (Electronic Stability Program) ..... 66  
ETS/4ETS (Electronic Traction System) ..... 67  
Important safety information ..... 65
- Driving safety systems**  
ABS (Anti-lock Braking System) ..... 65  
BAS (Brake Assist System) ..... 66  
Distance warning system (vehicles with DISTRONIC) ..... 69  
Overview ..... 65
- Driving systems**  
Blind Spot Assist ..... 189  
Cruise control ..... 171  
DISTRONIC ..... 173  
Level control ..... 181

- PARKTRONIC ..... 184
  - Rear view camera ..... 187
  - Driving tip**
  - Braking ..... 163
  - Driving tips** ..... 147
  - DISTRONIC ..... 179
  - Downhill gradients ..... 161
  - Driving on flooded roads ..... 164
  - Driving on sand ..... 168
  - Driving over obstacles ..... 169
  - Off-road driving ..... 167
  - Off-road fording ..... 164
  - Tire ruts ..... 169
  - Towing a trailer ..... 198
  - Wet road surface ..... 162
  - Winter ..... 166
  - DSR (Downhill Speed Regulation)** ..... 192
  - Display message ..... 239
  - Setting (on-board computer) ..... 219
  - DVD audio (on-board computer)** ..... 212
- E**
- EASY-ENTRY feature** ..... 100
  - Activating/deactivating (on-board computer) ..... 218
  - EASY-EXIT feature** ..... 100
  - Crash-responsive ..... 101
  - EASY-PACK cargo compartment management system** ..... 263
  - EASY-PACK load-securing kit** ..... 263
  - EBD (Electronic Brake force Distribution)**
  - Display message ..... 229
  - Function/notes ..... 68
  - Electrical fuses**
  - see Fuses
  - Electronic Brake-force Distribution)**
  - see EBD
  - Electronic Stability Program**
  - see ESP®
  - Electronic Traction System**
  - see ETS/4ETS
  - Emergency call**
  - see mbrace
  - Emergency release**
  - Fuel filler flap ..... 153
  - Vehicle ..... 80
  - Emergency running mode**
  - Automatic transmission ..... 151
  - Emergency spare wheel**
  - Storage location ..... 299
  - Stowing ..... 299
  - Emergency tensioning device**
  - Function ..... 57
  - Safety guidelines ..... 37
  - Emergency unlocking**
  - Tailgate ..... 84
  - Emissions purification**
  - Service and warranty information .... 19
  - Engine**
  - Irregular running ..... 143
  - Starting problems ..... 143
  - Starting the engine with the key .... 141
  - Starting with KEYLESS GO ..... 141
  - Switching off ..... 158
  - Warning lamp (engine diagnostics) ..... 252
  - Engine electronics**
  - Malfunction ..... 143
  - Engine emergency stop** ..... 322
  - Engine number** ..... 356
  - Engine oil**
  - Adding ..... 284
  - Checking the oil level ..... 283
  - Display message ..... 235
  - Lubricant additives ..... 361
  - Notes about oil grades ..... 361
  - Temperature (on-board computer) . 209
  - Viscosity ..... 361
  - ESP® (Electronic Stability Program)**
  - Activating/deactivating ..... 67
  - Display message ..... 223
  - ETS/4ETS ..... 67
  - Important safety information ..... 66
  - Trailer stabilization ..... 68
  - Warning lamp ..... 250
  - ETS/4ETS (Electronic Traction System)** ..... 67
  - Exhaust check** ..... 161

- Exhaust tail pipe (cleaning instructions)** ..... 291
- Exterior lighting**  
see Lights
- Exterior mirrors**  
Adjusting ..... 101  
Dipping (automatic) ..... 102  
Folding in/out (automatically) ..... 102  
Folding in/out (electrically) ..... 102  
Folding in when locking (on-board computer) ..... 218  
Out of position ..... 102  
Setting ..... 102  
Storing settings (memory function) ..... 103  
Storing the parking position ..... 103
- Exterior view** ..... 26
- F**
- Filling capacity**  
see Technical data
- First-aid kit** ..... 297
- Flat tire**  
Changing a wheel/mounting the spare wheel ..... 305  
MOExtended run-flat system ..... 311  
Preparing the vehicle ..... 300  
Raising the vehicle ..... 306  
TIREFIT kit ..... 301
- Floormat** ..... 279
- Front fog lamp (display message)** ..... 232
- Fuel**  
Additives ..... 359  
Notes ..... 358  
Premium-grade unleaded gasoline . 358  
Refueling ..... 151  
Specifications ..... 358  
Troubleshooting ..... 155
- Fuel consumption**  
Current (on-board computer) ..... 220  
Notes ..... 160
- Fuel filler cap (display message)** ..... 236
- Fuel filler flap**  
Emergency release ..... 153  
Opening/closing ..... 153
- Fuel filter (display message)** ..... 236
- Fuel level**  
Calling up the range (on-board computer) ..... 220
- Fuses**  
Dashboard fuse box ..... 321  
Engine emergency stop ..... 322  
Fuse allocation chart ..... 321  
Fuse box in the cargo compartment ..... 321  
Fuse box in the engine compartment ..... 321  
Notes ..... 320
- G**
- Garage door opener**  
Clearing the memory ..... 279  
Notes ..... 276  
Opening/closing the garage door .. 278  
Programming the remote control ... 276
- Gear indicator (on-board computer)** ..... 209
- Gear or selector lever (cleaning guidelines)** ..... 292
- Genuine Mercedes-Benz parts** ..... 354
- Genuine wood trim and trim strips (cleaning instructions)** ..... 292
- Glove box** ..... 257
- GTW (Gross Trailer Weight) (definition)** ..... 345
- H**
- Headlamp cleaning system** ..... 109  
Adding washer fluid ..... 286  
Notes ..... 363
- Headlamp delayed switch-off**  
see Delayed switch-off, exterior lighting
- Headlamp mode (daytime driving)**  
see Daytime running lamps
- Headlamps**  
Cleaning ..... 291  
Misting up ..... 110  
Setting ..... 116
- Head restraint**  
Adjusting (electrically) ..... 95
- Head restraints**  
Adjusting (manually) ..... 95

Adjusting (rear) .....	96
Installing/removing (rear) .....	96
Luxury .....	95
see NECK-PRO head restraints	
<b>Heating</b>	
see Climate control	
<b>High beam flasher</b> .....	109
<b>Hill start assist</b> .....	142
<b>Hood</b>	
Closing .....	283
Opening .....	282
<b>Hydroplaning</b> .....	163
<b>I</b>	
<b>Immobilizer</b> .....	69
<b>Indicator and warning lamps</b>	
ABS .....	249
Brakes .....	247
DISTRONIC .....	253
Engine diagnostics .....	252
ESP® .....	250
Fuel tank .....	252
Reserve fuel .....	252
Seat belt .....	248
SRS .....	251
Tire pressure monitor .....	253
<b>Insect protection on the radiator</b> ....	283
<b>Instrument cluster</b>	
Overview .....	28
Selecting the language (on-board computer) .....	214
Submenu (on-board computer) .....	214
Warning and indicator lamps .....	29
<b>Instrument cluster lighting</b> .....	28
<b>Instrument lighting</b>	
see Instrument cluster lighting	
<b>Interior lighting</b>	
Automatic control .....	111
Delayed switch-off (on-board computer) .....	217
Emergency lighting .....	111
Manual control .....	111
Reading lamp .....	110
Setting ambient lighting (on-board computer) .....	216
<b>ISOFIX (LATCH-type child seat securing system)</b> .....	61

**J****Jack**

Storage location .....	298
Using .....	306
<b>Jump-starting</b> .....	315

**K****Key**

Convenience closing feature .....	86
Convenience opening feature .....	86
Display message .....	245
Starting the engine .....	141

**KEYLESS-GO**

Button .....	139
Convenience closing feature .....	86
Locking .....	73
Starting the engine .....	141
Unlocking .....	73

**Key positions**

KEYLESS-GO .....	139
SmartKey .....	139

<b>Kickdown</b> .....	147, 149
-----------------------	----------

**L****Lane-change assistant**

see Blind Spot Assist

<b>Language (on-board computer)</b> .....	214
---	-----

<b>Level control</b> .....	181
----------------------------	-----

<b>Level control (display message)</b> .....	237
--	-----

**Level setting**

Basic settings .....	182
----------------------	-----

<b>License plate lamp (display message)</b> .....	232
---	-----

**Light**

Setting ambient lighting (on-board computer) .....	216
--	-----

**Lights**

Activating/deactivating the interior lighting delayed switch-off (on-board computer) .....	217
Automatic headlamp mode .....	107
Cornering light function .....	110
Daytime running lamps .....	107
Driving abroad .....	106
Fog lamps .....	108
Hazard warning lamps .....	109

- High-beam headlamps ..... 109
  - Light switch ..... 106
  - Low-beam headlamps ..... 107
  - Rear fog lamp ..... 108
  - Switching the daytime driving lights on/off (on-board computer) . 215
  - Switching the exterior lighting delayed switch-off on/off (on-board computer) ..... 216
  - Switching the surround lighting on/off (on-board computer) ..... 215
  - Light sensor (display message)** ..... 233
  - Loading guidelines** ..... 256
  - Locking**
    - Automatic ..... 79
    - Emergency locking ..... 80
    - From inside the vehicle (central locking button) ..... 79
  - Low-beam headlamp (display message)** ..... 230
  - LOW RANGE**
    - Display message ..... 238
    - Off-road gear ..... 194
  - LOW RANGE off-road gear** ..... 194
  - Luggage net** ..... 258
  - Lumbar support**
    - 4-way lumbar support ..... 97
  - Luxury head restraints** ..... 95
- M**
- Main-beam headlamps (display message)** ..... 231
  - Malfunction message**
    - see Display messages
  - Malfunctions relevant to safety**
    - Reporting ..... 23
  - Manual drive program** ..... 149
  - mbrace**
    - Call priority ..... 274
    - Display message ..... 224
    - Downloading destinations (COMAND) ..... 274
    - Emergency call ..... 271
    - Important safety notes ..... 270
    - Locating a stolen vehicle ..... 275
    - MB info call button ..... 273
    - Roadside Assistance button ..... 272
    - Self-test ..... 271
    - System ..... 271
    - Vehicle remote unlocking ..... 275
  - Mechanical key**
    - Function/notes ..... 75
  - Memory card (on-board computer)** . 212
  - Memory function** ..... 103
  - Menu (on-board computer)**
    - Additional functions ..... 219
    - AMG ..... 209
    - Audio ..... 211
    - DISTRONIC ..... 179
    - DVD ..... 212
    - Message memory ..... 222
    - Navigation ..... 212
    - Off-road ..... 213
    - Off-road mode ..... 211
    - Overview of menus ..... 207
    - Resetting to factory settings ..... 213
    - Settings ..... 213
    - Standard display ..... 208
    - Telephone ..... 220
    - Trip computer ..... 219
  - Messages**
    - see Display messages
  - Mirrors**
    - Sun visor ..... 266
    - see Exterior mirrors or Rear-view mirror
  - MOExtended run-flat system** ..... 311
  - MP3**
    - Operating (on-board computer) ..... 212
    - see separate operating instructions
  - Multicontour seat** ..... 97
  - Multifunction display** ..... 206
  - Multifunction steering wheel**
    - Operating the on-board computer . 205
    - Overview ..... 30
- N**
- Navigation**
    - On-board computer ..... 212
    - see separate operating instructions
  - NECK-PRO head restraints**
    - Operation ..... 52
    - Resetting triggered ..... 53
  - Notes on breaking-in a new vehicle** ..... 138

## O

**Occupant Classification System (OCS)**

Faults .....	47
Operation .....	42
System self-test .....	45

**Occupant safety**

Children in the vehicle .....	58
System overview .....	36

**OCS**

Faults .....	47
Operation .....	42
System self-test .....	45

**Octane number (fuel)** ..... 358**Odometer** ..... 208**Off-road**

4MATIC .....	191
Differential locks .....	196
DSR .....	192
LOW RANGE off-road gear .....	194
Off-road 4ETS .....	67
Off-road ABS .....	66
Off-road drive program .....	193

**Off-road drive program** ..... 193

On-board computer .....	211
-------------------------	-----

**Off-road driving** ..... 167

Important safety instructions .....	166
-------------------------------------	-----

**Off-road fording** ..... 164**Off-road terrain**

Off-road ESP .....	68
--------------------	----

**Oil**

see Engine oil

**On-board computer**

Additional functions menu .....	219
AMG menu .....	209
Audio menu .....	211
Convenience submenu .....	218
Displaying a service message .....	287
Displaying the coolant temperature .....	208
Displaying the outside temperature .....	208
Display messages .....	222
DISTRONIC menu .....	179
Factory settings .....	213
Important safety notes .....	204
Instrument cluster submenu .....	214

Lighting submenu .....	215
Message memory menu .....	222
Navigation menu .....	212
Off-road menu .....	213
Off-road mode .....	211
Operating video DVD .....	212
Operation .....	205
Overview of menus .....	207
Selecting the language .....	214
Settings menu .....	213
Standard display menu .....	208
Telephone menu .....	220
Time/Date submenu .....	215
Trip computer menu .....	219
Vehicle submenu .....	217

**Opening and closing the side trim**

panels .....	114
--------------	-----

**Operating system**

see on-board computer

**Outside temperature**

Calling up (on-board computer) .....	208
Display .....	204

**Overhead control panel**

Overview .....	32
----------------	----

**Override feature**

Rear side windows .....	64
-------------------------	----

## P

**Paint code number** ..... 355**Paintwork (cleaning instructions)** ... 290**Panic alarm** ..... 64**Parking** ..... 158**Parking aid**

PARKTRONIC .....	184
Rear view camera .....	187

**Parking brake** ..... 159**Parking lamp (display message)** ..... 232**Parking position**

Exterior mirror on the front-passenger side .....	103
---	-----

**PARKTRONIC** ..... 184

Activating/deactivating .....	186
Malfunction .....	187
Problem .....	187
Range of the sensors .....	185
Trailer towing .....	186
Warning display .....	185

<b>PASSENGER AIRBAG OFF indicator lamp (only Canada)</b> .....	48	<b>Rear-view mirror</b>	
<b>PASSENGER AIRBAG OFF indicator lamp (only USA)</b> .....	42	Anti-glare (manual) .....	101
<b>Pedals</b> .....	160	Dipping (automatic) .....	102
<b>Permanent four-wheel drive</b>		<b>Rear window heating</b>	
see 4MATIC		Malfunction .....	133
<b>Plastic trim (cleaning instructions)</b> .	292	Switching on/off .....	133
<b>Power supply (trailer)</b> .....	201	<b>Rear window wiper</b> .....	118
<b>Power washers</b> .....	289	Replacing the wiper blade .....	119
<b>Power windows</b>		<b>Refueling</b> .....	151
see Side windows		<b>Remote control</b>	
<b>Pre-emptive occupant safety system</b>		Programming (garage door opener) .....	276
see PRE-SAFE® system		<b>Reporting</b>	
<b>PRE-SAFE® system</b>		Malfunctions relevant to safety .....	23
Display message .....	224	<b>Reserve fuel</b>	
Operation .....	51	Display message .....	236
<b>Product information</b> .....	19	Warning lamp .....	252
<b>Program selector button</b> .....	147	<b>Reset button</b> .....	28
<b>Pulling away</b>		<b>Residual heat</b>	
Automatic transmission .....	141	Switching on/off .....	134
<b>R</b>			
<b>RACETIMER (on-board computer)</b> ....	209	<b>Restraint systems</b>	
<b>Radar sensor system (on-board computer)</b> .....	217	see SRS	
<b>Radiator cover</b> .....	283	<b>Reversing lamp (display message)</b> ..	232
<b>Radio</b>		<b>Roadside Assistance (breakdown)</b> ....	20
Changing a station (on-board computer) .....	211	<b>Roof carrier</b> .....	265
see separate operating instructions		<b>Roof lining and carpets (Cleaning guidelines)</b> .....	293
<b>Radio-controlled equipment</b>		<b>Route</b>	
Assembly .....	279	see Route guidance (on-board computer)	
<b>Range (on-board computer)</b> .....	220	<b>Route guidance (on-board computer)</b> .....	212
<b>Rear bench seat</b>		<b>S</b>	
Folding forwards/back .....	259	<b>Safety</b>	
<b>Rear compartment</b>		Children in the vehicle .....	58
Activating/deactivating climate control .....	129	Child restraint systems .....	59
Setting the air vents .....	135	Occupant Classification System (OCS) .....	42
Setting the temperature .....	131	Overview of occupant safety systems .....	36
<b>Rear fog lamp (display message)</b> ....	232	<b>Safety systems</b>	
<b>Rear view camera</b>		see Driving safety systems	
Function/notes .....	187	<b>Seat belts</b>	
<b>Rear view camera (cleaning instructions)</b> .....	291	Adjusting the driver's and front-passenger seat belt .....	56
		Adjusting the height .....	56

- Belt force limiters ..... 57
- Cleaning ..... 293
- Correct usage ..... 54
- Emergency Tensioning Devices ..... 57
- Fastening ..... 55
- Important safety guidelines ..... 53
- Releasing ..... 56
- Safety guidelines ..... 37
- Switching belt adjustment on/off  
(on-board computer) ..... 218
- Warning lamp ..... 248
- Warning lamp (function) ..... 57
- Seat heating**
- Indicator lamp (Malfunction) ..... 98
- Seats**
- Adjusting (electrically) ..... 94
- Adjusting the 4-way lumbar  
support ..... 97
- Adjusting the head restraint ..... 95
- Cleaning the cover ..... 292
- Correct driver's seat position ..... 92
- Important safety instructions ..... 93
- Multicontour seat ..... 97
- Storing settings (memory  
function) ..... 103
- Switching seat heating on/off ..... 97
- Switching the seat ventilation on/  
off ..... 98
- Seat ventilation**
- Indicator lamp (Malfunction) ..... 99
- Securing hooks** ..... 260
- Sensors (cleaning instructions)** ..... 291
- Service indicator**  
see Service interval display
- Service interval display** ..... 287
- Displaying a service message (on-  
board computer) ..... 287
- Service products**
- AdBlue® special additives ..... 360
- Brake fluid ..... 362
- Coolant (engine) ..... 362
- Engine oil ..... 361
- Filling capacity ..... 357
- Fuel ..... 358
- Important safety notes ..... 356
- Notes ..... 356
- Refrigerant (air-conditioning  
system) ..... 362
- Washer fluid ..... 363
- Settings**
- Factory (on-board computer) ..... 213
- On-board computer ..... 213
- Shift ranges** ..... 148
- Side impact air bag** ..... 40
- Side marker lamp (display  
message)** ..... 232
- Side windows**
- Convenience closing feature ..... 86
- Convenience opening feature ..... 86
- Important safety information ..... 84
- Opening/closing ..... 85
- Resetting ..... 87
- Troubleshooting ..... 87
- Sliding sunroof**
- Important safety information ..... 88
- Troubleshooting ..... 89
- see Tilt/sliding sunroof
- SmartKey**
- Changing the battery ..... 76
- Changing the programming ..... 75
- Checking the battery ..... 76
- Important safety notes ..... 72
- Malfunction ..... 77
- Snow chains** ..... 165
- Socket** ..... 268
- Dashboard ..... 268
- Front-passenger footwell ..... 268
- Luggage compartment ..... 269
- Rear compartment ..... 269
- SOS**  
see mbrace
- Spare wheel**
- Notes/data ..... 352
- Storage location ..... 299
- Stowing ..... 299
- see Emergency spare wheel
- Speedometer**
- Additional speedometer (on-  
board computer) ..... 208
- Segments ..... 205
- Setting the unit (on-board  
computer) ..... 214

- SRS (Supplemental Restraint System)**
    - Display message ..... 224
    - Introduction ..... 36
    - Warning lamp ..... 251
    - Warning lamp (function) ..... 36
  - Standard display (on-board computer)** ..... 208
  - Starting the engine**
    - Important safety instructions ..... 140
  - Station**
    - see Radio
  - Status line (on-board computer)**
    - Multifunction display ..... 206
    - Selecting the display ..... 214
  - Steering (display message)** ..... 244
  - Steering wheel**
    - Adjusting (electrically) ..... 100
    - Adjusting (manually) ..... 99
    - Buttons (on-board computer) ..... 205
    - Cleaning ..... 292
    - Important safety instructions ..... 99
    - Memory function (storing settings) ..... 100
    - Steering wheel heating ..... 100
    - Storing settings (memory function) ..... 103
  - Steering wheel heating**
    - Indicator lamp (Malfunction) ..... 100
  - Steering wheel paddle shifters** ..... 148
  - Storage compartments**
    - Armrest (under) ..... 257
    - Glove box ..... 257
  - Stowage space**
    - Center console ..... 257
    - Center console (rear) ..... 258
    - Cup holders ..... 265
    - Important safety information ..... 256
  - Submenu (on-board computer)**
    - Convenience ..... 218
    - Instrument cluster ..... 214
    - Lighting ..... 215
    - Time/Date ..... 215
    - Vehicle ..... 217
  - Summer opening**
    - see Convenience opening feature
  - Sun visor** ..... 266
  - Supplemental Restraint System**
    - see SRS
  - Surround lighting (on-board computer)** ..... 215
  - SUV**
    - (Sport Utility Vehicle) ..... 21
  - Switching off the alarm (ATA)** ..... 69
- T**
- Tachometer** ..... 204
  - Tailgate**
    - Display message ..... 244
    - Emergency unlocking ..... 84
    - Important safety guidelines ..... 80
    - Limiting the opening angle ..... 83
  - Taillight**
    - see Tail lamps
  - Tank contents**
    - Gauge ..... 28
  - Technical data** ..... 354
    - ML 350 ..... 364
    - ML 350 4MATIC ..... 364
    - ML 350 BlueTEC 4MATIC ..... 363
    - ML 550 4MATIC ..... 364
    - ML 63 AMG ..... 365
    - Tires/wheels ..... 347
  - TELEAID**
    - Call priority ..... 274
    - Display message ..... 224
    - Downloading destinations (COMAND) ..... 274
    - Emergency call ..... 271
    - Important safety notes ..... 270
    - Locating a stolen vehicle ..... 275
    - MB info call button ..... 273
    - Roadside Assistance button ..... 272
    - Self-test ..... 271
    - System ..... 271
    - Vehicle remote unlocking ..... 275
  - Telephone**
    - Accepting a call ..... 220
    - Display message ..... 245
    - Menu (on-board computer) ..... 220
    - Number from the phone book ..... 221
    - Redialing ..... 221
    - Rejecting/ending a call ..... 221
  - Telephone compartment** ..... 257

<b>Telescopic rod (EASY-PACK load-securing kit)</b> .....	264
<b>Temperature</b>	
Coolant (on-board computer) .....	208
Displaying the outside temperature .....	208
Engine oil (on-board computer) .....	209
Outside temperature .....	204
Setting .....	131
<b>Theft deterrent locking system</b>	
Immobilizer .....	69
<b>Tilt/sliding sunroof</b>	
Opening/closing .....	89
Resetting .....	89
<b>Time (on-board computer)</b> .....	215
<b>Timer (on-board computer)</b> .....	209
<b>TIREFIT kit</b> .....	301
<b>Tire pressure</b>	
Calling up (on-board computer) .....	331
Checking manually .....	329
Display message .....	241
Maximum .....	334
Notes .....	327
Not reached (TIREFIT) .....	303
Pressure loss warning .....	329
Reached (TIREFIT) .....	304
Recommended .....	326
<b>Tire pressure monitor</b>	
Warning lamp .....	253
<b>Tire pressure monitoring system</b>	
Function/notes .....	331
Restarting .....	333
<b>Tires</b>	
Aspect ratio (definition) .....	346
Average weight of the vehicle occupants (definition) .....	344
Bar (definition) .....	344
Characteristics .....	344
Checking .....	325
Cleaning .....	326
Definition of terms .....	344
Direction of rotation .....	338
Distribution of the vehicle occupants (definition) .....	347
DOT, Tire Identification Number (TIN) .....	343
DOT (Department of Transportation) (definition) .....	344
Flat tire .....	300
GAWR (Gross Axle Weight Rating) (definition) .....	345
GTW (Gross Trailer Weight) (definition) .....	345
Guidelines to be observed .....	325
GVW (Gross Vehicle Weight) (definition) .....	345
GVWR (Gross Vehicle Weight Rating) (definition) .....	345
Increased vehicle weight due to optional equipment (definition) .....	345
Kilopascal (kPa) (definition) .....	345
Labeling (overview) .....	340
Load bearing index (definition) .....	346
Load index .....	343
Load index (definition) .....	345
Maximum loaded vehicle weight (definition) .....	345
Maximum load on a tire (definition) .....	346
Maximum permissible tire pressure (definition) .....	346
Maximum tire load .....	338
Maximum tire loading (definition) ..	346
Optional equipment weight (definition) .....	346
PSI (pounds per square inch) (definition) .....	346
Replacing .....	340
Service life .....	325
Sidewall (definition) .....	346
Speed index (definition) .....	345
Storing .....	326
Structure and characteristics (definition) .....	344
Temperature .....	339
TIN (Tire Identification Number) (definition) .....	346
Tire bead (definition) .....	346
Tire pressure (definition) .....	346
Tire pressures (recommended) .....	344
Tire quality classes .....	338
Tire size (data) .....	347
Tire size designation, load-bearing capacity, speed index .....	341
Tire tread .....	325
Tire tread (definition) .....	346

- Total load limit (definition) ..... 347
  - Traction ..... 339
  - Traction (definition) ..... 346
  - Tread wear ..... 339
  - TWR (permissible trailer drawbar noseweight) (definition) ..... 347
  - Uniform tire quality classification standards (definition) ..... 344
  - Unladen weight (definition) ..... 345
  - Wear indicator (definition) ..... 347
  - Wheel rim (definition) ..... 345
  - Tires and wheels (important safety information)** ..... 324
  - Top Tether** ..... 62
  - Towing**
    - Important safety guidelines ..... 317
  - Towing a trailer**
    - Driving tips ..... 198
  - Towing away**
    - Installing the towing eye ..... 318
    - Removing the towing eye ..... 319
  - Trailer**
    - Coupling up ..... 198
    - Decoupling ..... 200
    - Display message ..... 230
    - Power supply ..... 201
    - Towing ..... 199
  - Trailer loads and drawbar noseweights** ..... 200
  - Trailer towing** ..... 147
    - Blind Spot Assist ..... 191
    - ESP® ..... 68
    - PARKTRONIC ..... 186
  - Transfer case** ..... 151
  - Transmission position display** ..... 145
  - Transmission positions** ..... 146
  - Traveling uphill**
    - Brow of hill ..... 171
    - Driving downhill ..... 171
    - Maximum gradient-climbing capability ..... 170
  - Trip computer (on-board computer)** ..... 219
  - Trip odometer**
    - Calling up ..... 208
    - Resetting (on-board computer) ..... 220
  - Trunk**
    - Automatic opening ..... 82, 83
  - Turn signal (display message)** ..... 230
  - Turn signals** ..... 109
  - TWR (permissible trailer drawbar noseweight) (definition)** ..... 347
  - Type plate**
    - see Vehicle identification plate
- ## U
- Unlocking**
    - Emergency unlocking ..... 80
    - From inside the vehicle (central unlocking button) ..... 79
- ## V
- Vanity mirror**
    - Sun visor ..... 266
  - Vehicle**
    - Data acquisition ..... 23
    - Emergency release ..... 80
    - Equipment ..... 19
    - Exterior view ..... 26
    - Individual settings (on-board computer) ..... 213
    - Loading ..... 334
    - Lowering ..... 310
    - Maintenance ..... 20
    - Parking up ..... 159
    - Raising ..... 306
    - Reporting problems ..... 22
    - Towing away ..... 317
    - Tow-starting ..... 317
    - Transporting ..... 319
  - Vehicle data**
    - see Technical data
  - Vehicle identification number**
    - see VIN
  - Vehicle identification plate** ..... 355
  - Vehicle tool kit** ..... 298
  - Video (DVD)** ..... 212
  - Video DVD (on-board computer)** ..... 212
  - VIN** ..... 355

## W

**Warning and indicator lamps**

Overview .....	29
PASSENGER AIRBAG OFF indicator lamp (only Canada) .....	48
PASSENGER AIRBAG OFF indicator lamp (only USA) .....	42

<b>Warranty</b> .....	354
-----------------------	-----

<b>Wheel bolt tightening torque</b> .....	310
---	-----

<b>Wheel chock</b> .....	306
--------------------------	-----

**Wheels**

Changing/replacing .....	340
Changing a wheel .....	305
Checking .....	325
Cleaning .....	289
Guidelines to be observed .....	325
Mounting a wheel .....	308
Removing a wheel .....	308
Tightening torque .....	310
Wheel size/tire size .....	347

<b>Window curtain air bag</b> .....	41
-------------------------------------	----

**Windows**

see Side windows

<b>Windows (cleaning instructions)</b> .....	290
--	-----

**Windshield**

Defrosting .....	132
Infrared reflective .....	279

<b>Windshield washer fluid (display message)</b> .....	245
--	-----

**Windshield washer system**

Adding washer fluid .....	286
Notes .....	363

**Windshield wipers**

Important safety notes .....	117
Replacing the wiper blades ....	118, 119
Switching on/off .....	117
Troubleshooting .....	120

<b>Winter operation</b> .....	166
-------------------------------	-----

Radiator cover .....	283
----------------------	-----

<b>Winter tires</b> .....	165
---------------------------	-----

**Wiper blades**

Cleaning .....	290
----------------	-----

## Product information

We recommend using genuine Mercedes-Benz parts as well as conversion parts and accessories explicitly approved by us for your vehicle model.

We have tested these parts to determine their reliability, safety and special suitability for Mercedes-Benz vehicles. Despite ongoing market research, Mercedes-Benz is unable to assess other parts. We cannot therefore be held responsible for them, even if in individual cases an official approval or authorization by governmental or other agencies should exist. The use of non-approved parts could affect your vehicle's operating safety. Mercedes-Benz therefore recommends that you use genuine Mercedes-Benz parts, conversion parts and accessories that have been approved for the type of vehicle. Genuine Mercedes-Benz parts, approved conversion parts and accessories are available from any authorized Mercedes-Benz Center. In addition, you will receive advice about permissible technical modifications, and the parts will be professionally installed.

## Operator's Manual

### Notes on the Operator's Manual

This Operator's Manual contains a great deal of helpful information. We urge you to read it carefully and familiarize yourself with the vehicle before driving.

For your own safety and longer service life of the vehicle, we urge you to follow the instructions and warnings contained in this Operator's Manual. Ignoring them could result in damage to the vehicle or personal injury to you or others. Vehicle damage caused by failure to follow instructions is not covered by the Mercedes-Benz Limited Warranty.

## Vehicle equipment

This manual describes all the standard and optional equipment of your vehicle available at the time of publication of the Operator's Manual. Country-specific differences are possible. Note that your vehicle may not be equipped with all functions described. This also refers to safety-related systems and functions. The equipment in your vehicle may therefore differ from that shown in the descriptions and illustrations. All the systems found in your vehicle are listed in the original purchase agreement of your vehicle. Should you have any questions concerning equipment and operation, please consult an authorized Mercedes-Benz Center.

The Operating Instructions and the Maintenance Booklet are important documents and should be kept in the vehicle.

## Service and vehicle operation

### Service and literature

The Service and Warranty Information booklet contains detailed information about the warranties covering your vehicle. Your authorized Mercedes-Benz Center will replace and repair any factory-fitted parts based on the terms and conditions of the following warranties:

- New Vehicle Limited Warranty
- Emission System Warranty
- Emission Performance Warranty
- California, Connecticut, Maine, Massachusetts, New York, Pennsylvania, Rhode Island and Vermont Emission Control System Warranty<sup>2</sup>
- State Warranty Enforcement Laws (Lemon Laws)

<sup>2</sup> Valid only for vehicles with a gasoline engine.

### Information for customers in California

Under California law you may be entitled to a replacement of your vehicle or a refund of the purchase price or lease price, if after a reasonable number of repair attempts Mercedes-Benz USA, LLC and/or its authorized repair or service facilities fail to fix one or more substantial defects or malfunctions in the vehicle that are covered by its express warranty. During the period of 18 months from original delivery of the vehicle or the accumulation of 18 000 miles (approximately 29 000 km) on the odometer of the vehicle, whichever occurs first, a reasonable number of repair attempts is presumed for a retail buyer or lessee if one or more of the following occurs:

- (1) the same substantial defect or malfunction results in a condition that is likely to cause death or serious bodily injury if the vehicle is driven, that defect or malfunction has been subject to repair two or more times, and you have directly notified Mercedes-Benz USA, LLC in writing of the need for its repair.
- (2) the same substantial defect or malfunction of a less serious nature than category (1) has been subject to repair four or more times and you have directly notified Mercedes-Benz in writing of the need for its repair.
- (3) the vehicle is out of service by reason of repair of the same or different substantial defects or malfunctions for a cumulative total of more than 30 calendar days.

Please send your written notice to:

Mercedes-Benz USA, LLC  
Customer Assistance Center  
One Mercedes Drive  
Montvale, NJ 07645-0350

### Maintenance

The Service and Warranty Information Booklet describes all necessary maintenance work that should be performed at regular intervals.

Always have the Service and Warranty Information Booklet with you when you bring the vehicle to an authorized Mercedes-Benz Center. The service advisor will record each service in the Service and Warranty Information Booklet for you.

### Roadside Assistance

The Mercedes-Benz Roadside Assistance Program provides factory-trained technical help in the event of a breakdown. Calls to the toll-free Roadside Assistance number will be answered by Mercedes-Benz Customer Assistance Representatives 24 hours a day, 365 days a year.

**1-800-FOR-MERCedes(1-800-367-6372)  
(USA)**

**1-800-387-0100 (Canada)**

For additional information refer to the Mercedes-Benz Roadside Assistance Program brochure (in the USA) or the Roadside Assistance section of the Service and Warranty Information Booklet (in Canada) You will find both in your vehicle literature portfolio.

In accordance with standard program guidelines, Roadside Assistance is prepared to provide vehicle service up until a reasonable distance from the next paved roadway. We will make every effort to assist in a breakdown situation. However, the accessibility of your vehicle will be determined by our authorized Mercedes-Benz Service technician or the tow service provider on a case-by-case basis.

Additional charges may be applicable for a breakdown location determined not to be a reasonably accessible roadside location as determined by our authorized technician and tow service provider.

### Change of address or ownership

In the event of a change of address, be sure to send in the "Change of Address Notice" found in the Service and Warranty Information Booklet, or simply call the Mercedes-Benz Customer Assistance Center (in the USA) at 1-800-FOR-MERCEdes (1-800-367-6372) or Customer Service (in Canada) at 1-800-387-0100. This will assist us in contacting you in a timely manner should the need arise.

If you sell your Mercedes, please leave all literature with the vehicle to make it available to the next operator.

If you bought this vehicle used, be sure to send in the "Notice of Purchase of Used Truck" found in the Service and Warranty Information Booklet, or call the Mercedes-Benz Customer Assistance Center (in the USA) at 1-800-FOR-MERCEdes (1-800-367-6372) or Customer Service (in Canada) at 1-800-387-0100.

### Vehicle operation outside the USA and Canada

If you plan to operate your vehicle in foreign countries, please be aware that:

- Service facilities or replacement parts may not be readily available.
- Unleaded gasoline for vehicles with catalytic converters may not be available. The use of leaded fuels can damage the catalytic converter.
- Gasoline may have a considerably lower octane rating. Improper fuel can cause engine damage.

### Sport Utility Vehicle

#### **Warning!**

This Sport Utility Vehicle is designed for both on-road and off-road use. It can go places and perform tasks for which conventional 2-wheel

drive passenger cars are not intended. This vehicle will handle and maneuver differently from conventional passenger cars in driving conditions which may occur on streets, highways and off-road use.

This vehicle has a higher ground clearance and a higher center of gravity than many passenger cars. As with other vehicles of this type, if you make sharp turns at excessive speeds or abrupt maneuvers, the vehicle may roll over or may go out of control and crash. Utility vehicles have a significantly higher rollover rate than other types of vehicles. Failure to operate this vehicle safely may result in an accident, rollover of the vehicle, and severe or fatal injury.

Before you start to drive this vehicle, read the Operator's Manual. Take time to become familiar with the driving characteristics of this vehicle. Be sure you are familiar with all vehicle controls. Learn how your vehicle handles on different road surfaces. Do not attempt sharp turns at excessive speeds or abrupt maneuvers or other unsafe driving actions that can cause loss of vehicle control. When driving off-road or working the vehicle hard, do not overload it. And, always wear your seat belts at all times. In a rollover crash, an unbelted person is significantly more likely to die than a person wearing a seat belt.

### Operating safety

#### Safety notes

#### **Warning**

Work improperly carried out on electronic components and associated software could cause them to cease functioning. Because the vehicle's electronic components are interconnected, any modifications made may produce an undesired effect on other systems. Electronic malfunctions could seriously impair the operating safety of your vehicle.

Contact an authorized Mercedes-Benz Center for repairs or modifications to electronic components.

Other improper work or modifications on the vehicle could also have a negative impact on the operating safety of the vehicle.

Some safety systems only function when the engine is running. You should therefore never turn off the engine while driving.

### **Warning**

Heavy blows against the vehicle underbody or tires/wheels may cause serious damage and impair the operating safety of your vehicle. Such blows can be caused, for example, by running over an obstacle, road debris or a pothole. If you feel a sudden significant vibration or ride disturbance, or you suspect that damage to your vehicle has occurred:

- turn on your hazard warning flashers.
- slow down carefully.
- drive with caution to an area which is a safe distance from the road.

Inspect the vehicle underbody and tires/wheels for possible damage. If the vehicle appears unsafe, have it towed to the nearest authorized Mercedes-Benz Center or other qualified maintenance or repair facility for further inspection or repairs.

## **Proper use of the vehicle**

To ensure proper use of the vehicle, you must familiarize yourself with the following information and rules:

- safety notes in this Operator's Manual
- technical data in this Operator's Manual
- traffic rules and regulations
- laws and safety standards pertaining to motor vehicles

### **Warning!**

Various warning labels are attached to your vehicle. These warning labels are intended to make you and others aware of various risks.

Do not remove any of these warning labels unless explicitly instructed to do so by information on the label itself.

Removing warning labels may cause you and others to be unaware of certain risks which may result in an accident and/or personal injury.

### **Warning!**

HYBRID vehicles: It is imperative that you read the HYBRID Supplemental Operating Instructions included in your vehicle literature portfolio. You may otherwise not receive all necessary safety information and warning for the operation of your vehicle.

## **Problems with your vehicle**

If you should experience a problem with your vehicle, particularly one that you believe may affect its safe operation, we urge you to contact an authorized Mercedes-Benz Center immediately to have the problem diagnosed and rectified. If the problem is not resolved to your satisfaction, please discuss the problem with the Mercedes-Benz Center again or, if necessary, contact us at one of the following addresses.

### **In the USA**

Customer Assistance Center  
Mercedes-Benz USA, LLC  
One Mercedes Drive  
Montvale, NJ 07645-0350

### **In Canada**

Customer Relations Department  
Mercedes-Benz Canada, Inc.  
98 Vanderhoof Avenue  
Toronto, Ontario M4G 4C9

## Reporting malfunctions relevant to safety

For the USA only:

The following text is reproduced as required of all manufacturers according to Title 49, Code of U.S. Federal Regulations, Part 575 pursuant to the National Traffic and Motor Vehicle Safety Act of 1966.

### Reporting safety defects

If you believe that your vehicle has a defect which could cause a crash or could cause injury or death, you should immediately inform the National Highway Traffic Safety Administration (NHTSA) in addition to notifying Mercedes-Benz USA, LLC.

If NHTSA receives similar complaints, it may open an investigation, and if it finds that a safety defect exists in a group of vehicles, it may order a recall and remedy campaign. However, NHTSA cannot become involved in individual problems between you, your dealer, or Mercedes-Benz USA, LLC.

To contact NHTSA, you may call the Vehicle Safety Hotline toll-free at 1-888-327-4236 (TTY:

1-800-424-9153 [http://](http://www.safercar.gov)

[www.safercar.gov](http://www.safercar.gov)); go to ; or write to:

Administrator, NHTSA Headquarters,  
1200 New Jersey Avenue, SE, West Building,  
Washington, DC 20590.

You can also obtain additional information about vehicle safety from:

<http://www.safercar.gov>.

## Limited Warranty

**!** Follow the instructions in this manual about the proper operation of your vehicle as well as about possible vehicle damage. Damage to your vehicle that arises from culpable contraventions against these instructions are not covered either by Mercedes-Benz Limited Warranty or by the

New or Used-Vehicle Warranty of Daimler AG.

## Data stored in the vehicle

### Information regarding electronic recording devices

(Including California Code Supplement § 9951)

Please note that your vehicle is equipped with devices that can record vehicle systems data. If your vehicle is equipped with mbrace<sup>3</sup> data is transmitted in the event of an accident.

This information serves, for example, to test vehicle systems after an accident and to continually improve vehicle safety.

Daimler AG can access this data and submit it:

- for safety research or vehicle diagnosis purposes
- with the consent of the vehicle owner or lessee
- in response to an official request by law enforcement or other government agency
- for use in arbitration of disputes that involve Daimler AG, its subsidiaries or its sales and service organizations
- as otherwise required or permitted by law

Please observe the mbrace<sup>3</sup> order agreement regarding further details on data that this system records and transmits.

<sup>3</sup> The system is called TELEAID in Canada.



Exterior view .....	26
Cockpit .....	27
Instrument cluster .....	28
Multifunction steering wheel .....	30
Center console .....	31
Overhead control panel .....	32
Door control panel .....	33

## Exterior view

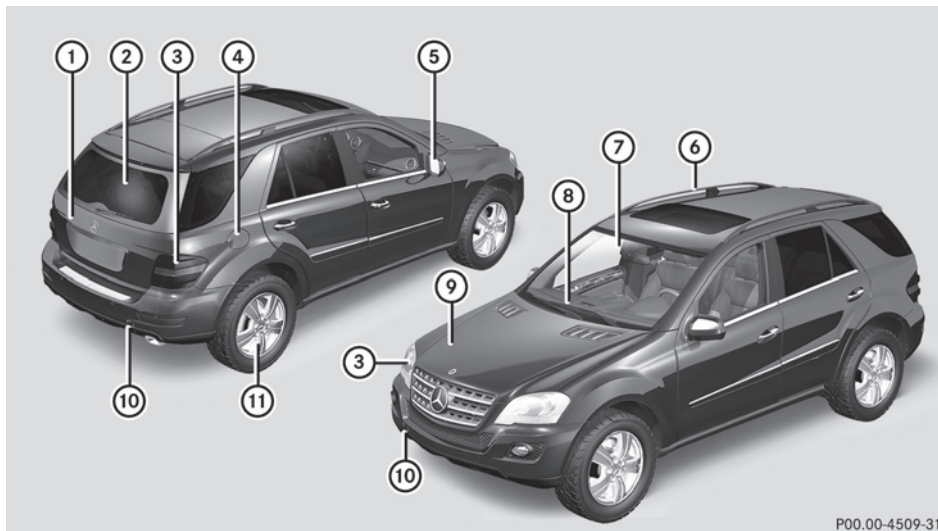

P00.00-4509-31

	Function	Page
①	Tailgate Vehicle tool kit	80 298
②	Rear window heating	133
③	Lights	111
④	Fuel filler flap	151
⑤	Exterior mirrors	101
⑥	Roof carrier Sliding sunroof	265 88
⑦	Defrosting the windshield Cleaning the windows	132 290

	Function	Page
⑧	Windshield wipers	117
⑨	Opening the hood Engine oil Coolant	282 283 285
⑩	Towing away	317
⑪	Tires and wheels Flat tire	324 300

## Cockpit

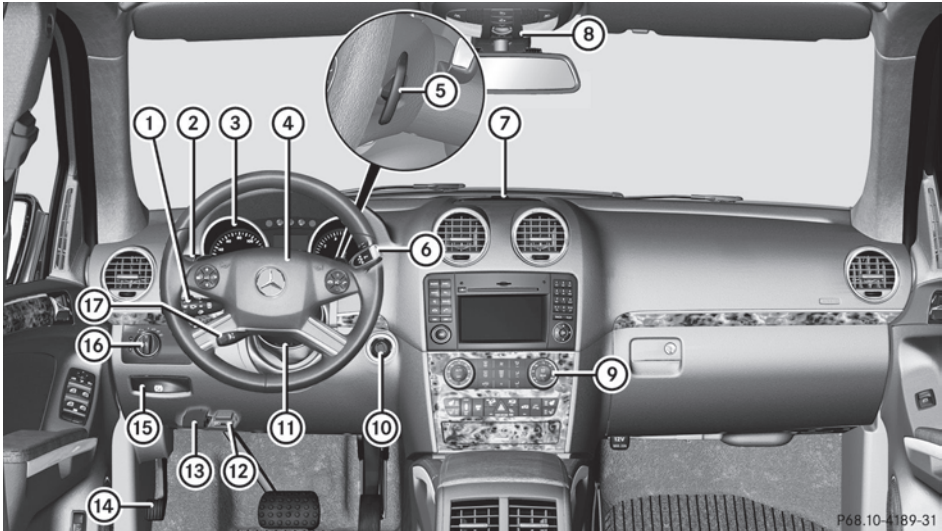

P68.10-1189-31

	Function	Page		Function	Page
①	Combination switch	109	⑩	Ignition lock Start/Stop button	139
②	Cruise control lever	172	⑪	Adjusts the steering wheel manually	99
③	Instrument cluster	28	⑫	On-board diagnostic socket	
④	Horn		⑬	Opens the hood	282
⑤	Steering wheel paddle shifters	148	⑭	Parking brake	158
⑥	DIRECT SELECT lever	144	⑮	Releases the parking brake	158
⑦	PARKTRONIC warning display	184	⑯	Light switch	106
⑧	Overhead control panel	32	⑰	Adjusts the steering wheel electrically	99
⑨	Operates the automatic climate control system	122		Steering wheel heating	100

## Instrument cluster

## Overview

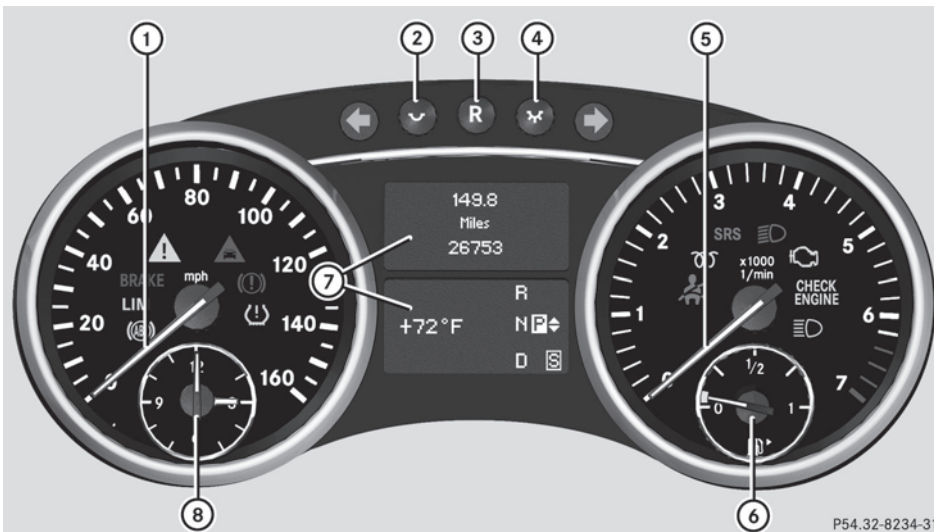

P54.32-8234-31

	Function	Page
①	Speedometer	
②	Sets the instrument cluster lighting: dimmer	
③	Reset button	
④	Sets the instrument cluster lighting: brighter	

	Function	Page
⑤	Tachometer	204
⑥	Fuel gauge	
⑦	Multifunction display	206
⑧	Clock	215

## Warning and indicator lamps

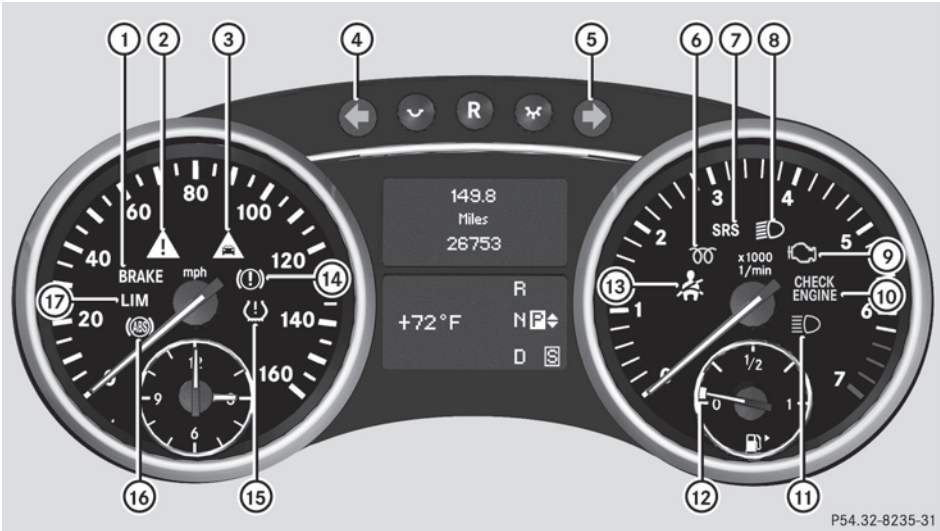

P54.32-8235-31

	Function	Page
①	Brakes (USA only)	247
②	ESP®	250
③	Distance warning lamp <sup>4</sup>	253
④	Turn signal	109
⑤	Turn signal	109
⑥	Diesel engine: preglow	141
⑦	SRS	251
⑧	Low-beam headlamps	107
⑨	Engine diagnostics (Canada only)	252
⑩	Engine diagnostics (USA only)	252





	Function	Page
⑪	High-beam headlamps	109
⑫	Reserve fuel	252
⑬	Seat belt	248
⑭	Brakes (Canada only)	247
⑮	Tire pressure monitor (USA only)	253
⑯	ABS	249
⑰	The lamp lights up briefly, but has no function.	



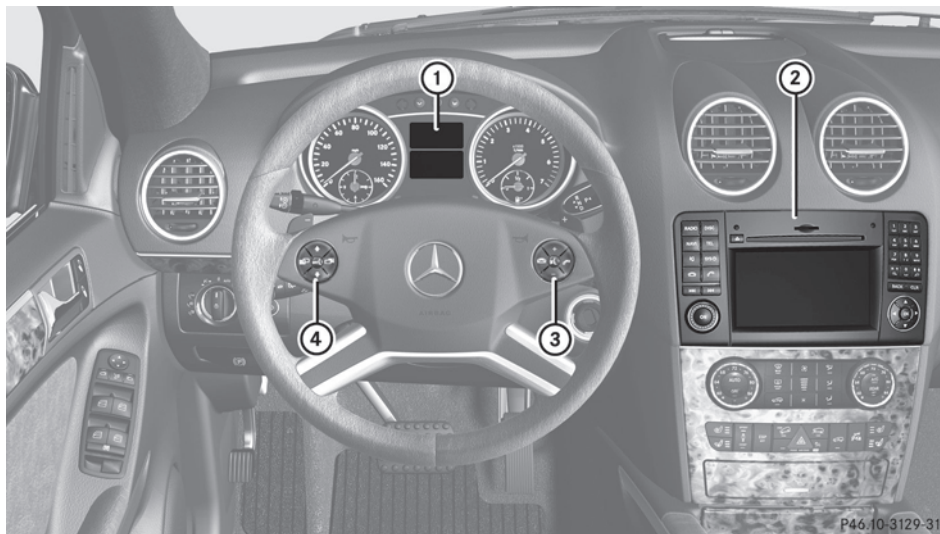

<sup>4</sup> On vehicles without DISTRONIC, the lamp lights up briefly but has no function.

Multifunction steering wheel

At a glance



	Function	Page
①	Multifunction display	206
②	COMAND APS; see the separate operating instructions	
③	  Makes/accepts or rejects/ends a call 220   Selects submenus in the Settings menu 213 Changes values Adjusts the volume Operates RACETIMER in AMG vehicles 209 	
	Switches on the Voice Control System; see the separate operating instructions	

	Function	Page
④	  Selects a menu: scrolls back and forth 207  Switches off the Voice Control System; see the separate operating instructions   Scrolls back and forth within a menu 207	

## Center console

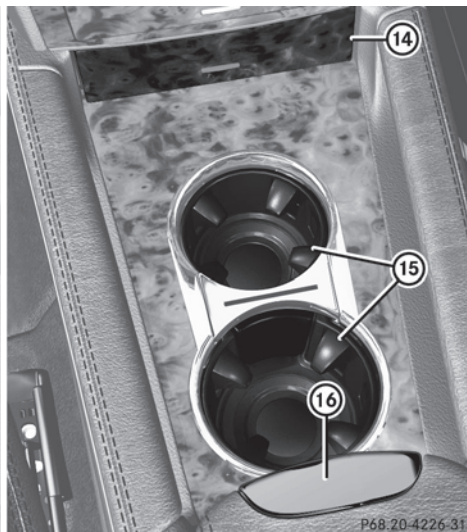
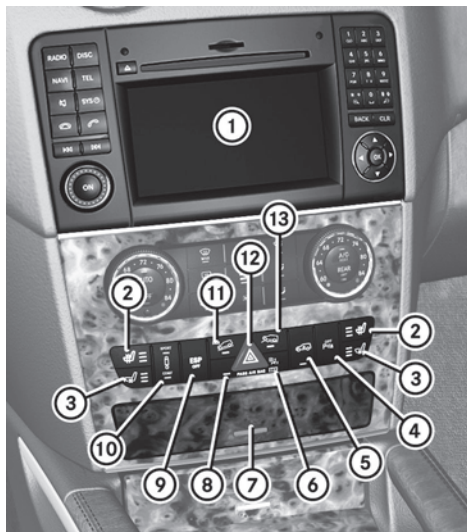

P68.20.4226.31





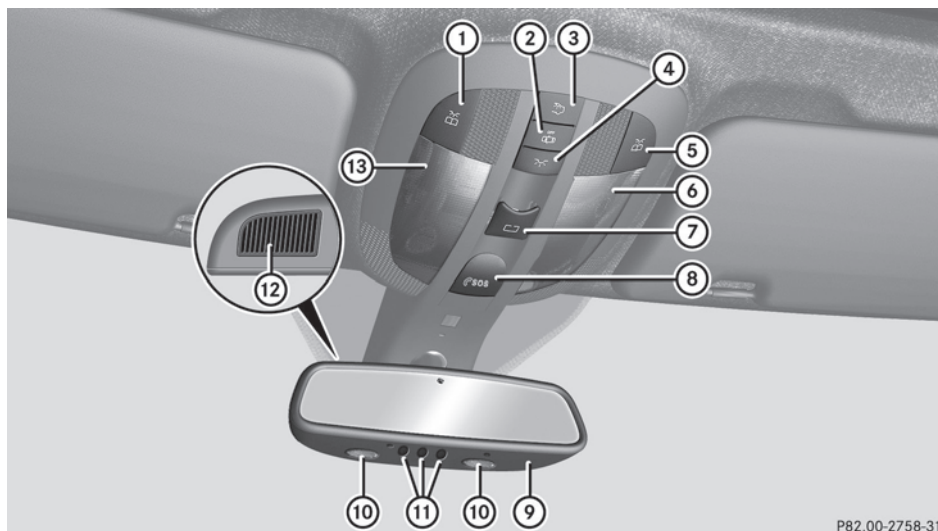

	Function	Page
①	COMAND APS; see the separate operating instructions	
②	Seat heating	97
③	Seat ventilation	98
④	PARKTRONIC	184
⑤	Level control	181
⑥	 PASS AIR BAG OFF indicator lamp (USA only)	42
⑦	Stowage compartment	256
⑧	ATA indicator lamp	69

	Function	Page
⑨	ESP®	66
⑩	Selects ADS settings	184
⑪	DSR	192
⑫	Hazard warning lamps	109
⑬	Offroad program AMG vehicles: selects the drive program	193 147
⑭	Ashtray Cigarette lighter	267 267
⑮	Cup holder	265
⑯	Stowage compartment	256

## Overhead control panel



P82.00-2758-31

	Function	Page
①	 To switch the left-hand reading lamp on/off	110
②	 To switch the automatic interior lighting control on/off	111
③	 To switch the rear interior lighting on/off	111
④	 To switch the front interior lighting on/off	111
⑤	 To switch the right-hand reading lamp on/off	110
⑥	Right-hand side interior lighting	111
⑦	 To open/close the tilt/sliding sunroof	89







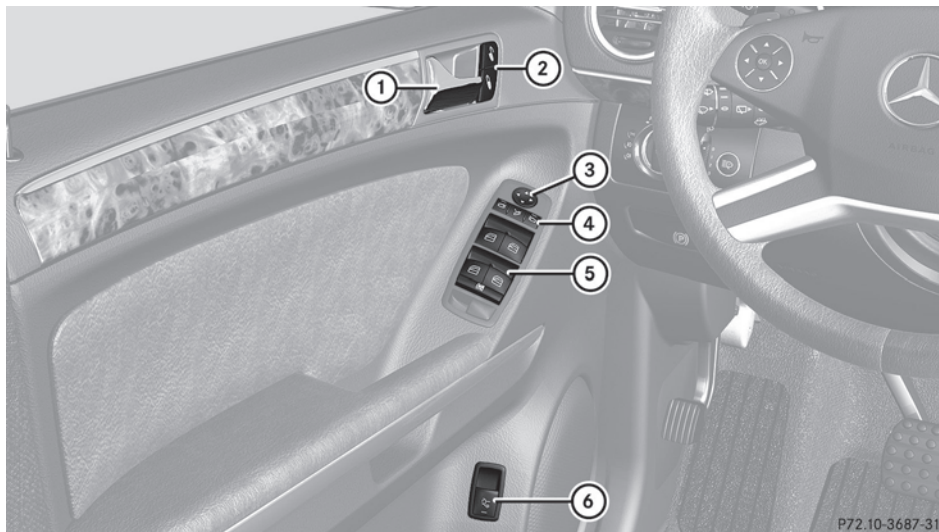

	Function	Page
⑧	 SOS button (mbrace system)	271
⑨	Rear-view mirror	101
⑩	Reading lamps	110
⑪	Buttons for the garage door opener	276
⑫	Microphone for mbrace (emergency call system), telephone and Voice Control System <sup>5</sup>	
⑬	Left-hand side interior lighting	111

<sup>5</sup> Observe the additional operating instructions.

## Door control panel



P72.10-3687-31

	Function	Page
①	Opens the door	79
②	  Locks/unlocks the vehicle	79
③	 Adjusts the exterior mirrors	101
④	   Selects the exterior mirror, electrically folds the exterior mirrors in/out	101
⑤	 Opens/closes the side windows	85
	 Activates/deactivates the override feature for the side windows in the rear compartment	64
⑥	 Opens/closes the tailgate	82



<b>Vehicle equipment .....</b>	<b>36</b>
<b>Occupant safety .....</b>	<b>36</b>
<b>Children in the vehicle .....</b>	<b>58</b>
<b>Panic alarm .....</b>	<b>64</b>
<b>Driving safety systems .....</b>	<b>65</b>
<b>Anti-theft systems .....</b>	<b>69</b>

## Vehicle equipment

**i** This manual describes all the standard and optional equipment of your vehicle which was available at the time of purchase. Country-specific differences are possible. Bear in mind that your vehicle may not feature all functions described here. This also refers to safety-related systems and functions.

## Occupant safety

### Overview of occupant safety

In this section you will learn the most important facts about the restraint system components of the vehicle.

The restraint systems are:

- Seat belts
- Child restraint systems
- "LATCH" type child seat mountings

Additional protection is provided by:

- SRS (Supplemental Restraint System)
- NECK-PRO head restraints
- PRE-SAFE®
- Air bag system components with:
  - PASSENGER air bag OFF indicator lamp
  - USA only: front-passenger seat with Occupant Classification System (OCS)
  - Canada only: front-passenger seat with BabySmart™ air bag deactivation system

The protective functions of the systems work in conjunction with each other. The systems are, however, autonomous.

### **Warning!**

Modifications to or work improperly conducted on restraint system components or their wiring, as well as tampering with interconnected electronic systems, can lead to the restraint systems no longer functioning as intended.

Air bags or Emergency Tensioning Devices/ belt buckle tensioners, for example, could deploy inadvertently or fail to deploy. Therefore, never modify the restraint systems. Do not tamper with electronic components or their software.

**i** More information on the subject of children in the vehicle and child restraint systems can be found under the "Children in the vehicle" chapter (> page 58).

## SRS (Supplemental Restraint System)

### Introduction

SRS reduces the risk of occupants coming into contact with the vehicle's interior in the event of an accident. It can also reduce the effect of the forces to which occupants are subjected during an accident.

SRS consists of:

-  SRS warning lamp
- air bags
- air bag control unit (with crash sensors)
- ETDs/belt buckle tensioners
- belt force limiters

### SRS warning lamps

SRS functions are checked regularly when you switch on the ignition and when the engine is running. Therefore, malfunctions can be detected in good time.

The  SRS warning lamp in the instrument cluster lights up when the ignition is switched on. It goes out no later than a few seconds after the engine is started.

The SRS components are in operational readiness when the  indicator lamp goes out while the engine is running.

**⚠ Warning**

The SRS self-check has detected a malfunction if the **SRS** SRS warning lamp:

- does not illuminate
- goes out approximately 4 seconds after the engine is started
- illuminates after the engine is started or illuminates during the journey

For your safety, Mercedes-Benz recommends that you have the system checked as soon as possible at an authorized Mercedes-Benz Center. Otherwise the SRS may not be activated when it is needed in an accident, which could result in serious or fatal injury. The SRS might also deploy unexpectedly and unnecessarily which could also result in injury.

In addition, improper work on the SRS creates a risk of rendering the SRS inoperative or causing unintended air bag deployment. Work on the SRS must therefore only be performed by qualified technicians. Contact an authorized Mercedes-Benz Center.

Contact an authorized Mercedes-Benz Center if it is necessary to modify an air bag system to accommodate a person with disabilities. USA only: Call our Customer Assistance Center at 1-800-FOR-MERCEdes (1-800-367-6372) for details.

### Safety guidelines for seat belts, Emergency Tensioning Devices (ETDs) and air bags

**⚠ Warning**

- Damaged seat belts or seat belts that have been subjected to stress in an accident must be replaced. Their anchoring points must also be checked. Only use seat belts installed or supplied by an authorized Mercedes-Benz Center.
- Air bags and pyrotechnic Emergency Tensioning Devices (ETDs) contain perchlorate material, which may require special handling and regard for the

environment. Check your national disposal guidelines. California residents, see [www.dtsc.ca.gov/HazardousWaste/Perchlorate/index.cfm](http://www.dtsc.ca.gov/HazardousWaste/Perchlorate/index.cfm).

- Air bags and ETDs are designed to function on a one-time-only basis. An air bag or ETD that has deployed must be replaced. PRE-SAFE® has electrically operated reversible belt tensioners in addition to the pyrotechnic ETDs.
- Do not pass seat belts over sharp edges. They could tear.
- Do not make any modification that could change the effectiveness of the seat belts.
- Do not bleach or dye seat belts as this may severely weaken them. In a crash they may not be able to provide adequate protection.
- No modifications of any kind may be made to any components or wiring of the SRS.
- Do not change or remove any component or part of the SRS.
- Do not install additional trim material, seat covers, badges, etc. to the:
  - padded steering wheel boss
  - front-passenger air bag cover
  - outer side of front seat bolsters
  - outer side of the seat bolsters of the rear bench seat backrest
  - roof lining trim
- Do not install additional electrical/electronic equipment on or near SRS components and wiring.
- Keep area between air bags and occupants free of objects (e.g. packages, purses, umbrellas, etc.).
- Do not hang items such as coat hangers from the coat hooks or handles over the door. These items may be thrown around in the vehicle and cause head and other injuries when the window curtain air bag is deployed.
- Air bag system components will be hot after an air bag has inflated. Do not touch them.

- Never place your feet on the instrument panel, dashboard, or on the seat. Always keep both feet on the floor in front of the seat.
- Improper repair work on the SRS creates a risk of rendering the SRS inoperative or causing unintended air bag deployment. Work on the SRS must therefore only be performed by qualified technicians. Contact an authorized Mercedes-Benz Center.
- For your protection and the protection of others, when scrapping the air bag unit or ETD, our safety instructions must be followed. These instructions are available from any authorized Mercedes-Benz Center.
- Given the considerable deployment speed, required inflation volume, and the material of the air bags, there is the possibility of abrasions or other, potentially more serious injuries resulting from air bag deployment.

If you sell your vehicle, Mercedes-Benz strongly recommends that you inform the subsequent owner that the vehicle is equipped with SRS. Also refer them to the applicable section in the Operator's Manual.

## Air bags

### Important safety guidelines

#### Warning

Air bags are designed to reduce the incidence of injuries and fatalities in certain situations:

- frontal impacts (driver's and front-passenger front air bags)
- side impacts (side impact air bags and window curtain air bags)
- rollover (window curtain air bags)

However, no system available today can completely eliminate injuries and fatalities.

When the air bags are deployed, a small amount of powder is released. The powder

generally does not constitute a health hazard and does not indicate that there is a fire in the vehicle. In order to prevent potential breathing difficulties, you should leave the vehicle as soon as it is safe to do so. If you have any breathing difficulty but cannot get out of the vehicle after the airbag inflates, then get fresh air by opening a window or door.

#### Warning

To reduce the risk of injuries during front air bag inflation, the driver and front-passenger must always be seated correctly and have their seat belts fastened accordingly.

For maximum protection in the event of a collision, you must always be in the normal seat position with your back against the backrest. Fasten your seat belt and make sure it is properly positioned on your body.

Since the air bag inflates with considerable speed and force, a proper seating position and correct positioning of the hands on the steering wheel will help to keep you at a safe distance from the air bag. Occupants who are not wearing their seat belt, are not seated properly or are too close to the air bag can be seriously injured or killed by an air bag as it inflates with great force instantaneously:

- Sit with the seat belt properly fastened in a position that is as upright as possible with your back against the seat backrest.
- Move the driver's seat as far back as possible, still permitting proper operation of vehicle controls. The distance from the center of the driver's chest to the center of the air bag cover on the steering wheel must be at least 10 inches (25 cm) or more. You should be able to accomplish this by adjusting the seat and steering wheel. If you have any difficulties, please contact an authorized Mercedes-Benz Center.
- Do not lean your head or chest close to the steering wheel or dashboard.
- Keep hands on the outside of the steering wheel rim. Placing hands and arms inside

the rim can increase the risk and potential severity of hand/arm injury when the driver front air bag inflates.

- Adjust the front-passenger seat as far back as possible from the dashboard when the seat is occupied.
- Occupants, especially children, should never place their bodies or lean their heads in the area of the door where the side impact air bag inflates. This could result in serious injuries or death should the side impact air bags be deployed. Always sit as upright as possible, wear the seat belt properly and use an appropriately sized child restraint, infant restraint or booster seat recommended for the size and weight of the child.
- Canada only: Children 12 years old and under must never ride in the front seat, except in an authorized Mercedes-Benz child restraint that is compatible with the BabySmart™ child restraint system. The BabySmart™ air bag deactivation system installed in the vehicle will deactivate the front-passenger front air bag when it is installed properly. Otherwise, the child could be struck by the air bag when it inflates in a crash. This could lead to serious or fatal injury.

Failure to follow these instructions can result in severe injuries to you or other occupants.

If you sell your vehicle, it is important that you make the buyer aware of this safety information. Be sure to give the buyer this Operator's Manual.

### **Warning**

Accident research shows that the safest place for children in an automobile is in a rear seat. A side impact air bag related injury may occur if occupants, especially children, are not properly seated or restrained when next to a side impact air bag which needs to deploy rapidly in a side impact in order to do its job.

To help avoid the possibility of injury, please follow these guidelines:

- (1) Always sit as upright as possible and use the seat belts properly. Make sure that children 12 years old and under use an appropriately sized child restraint, infant restraint, or booster seat recommended for the size and weight of the child.
- (2) Always wear seat belts properly.

The air bags are only deployed if the airbag control unit detects the need for deployment. Only in the event of such a situation will they provide their supplemental protection.

The driver and passenger should always wear their seat belts. Otherwise, it is not possible for the air bags to provide their supplemental protection.

In the event of other types of impacts and impacts below air bag deployment thresholds, air bags will not deploy. The driver and passengers will then be protected to the extent possible by a properly fastened seat belt. A properly fastened seat belt is also needed to provide the best possible protection in a rollover.

Air bags offer supplemental protection but are not a substitute for seat belts. All vehicle occupants must fasten their seat belts regardless of whether your vehicle is equipped with airbags or not.

It is important for your safety and that of your passenger to have deployed air bags replaced and to have any malfunctioning air bags repaired. This will help to make sure the air bags continue to perform their protective function for the vehicle occupants in the event of a crash.

### **Front air bags**

#### **Warning**

Observe "Important safety instructions" (▷ page 38).

The front air bags increase protection for the driver's and front-passenger's head and chest.

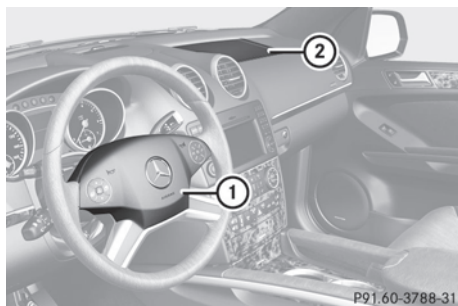

Driver's front air bag ① deploys in front of the steering wheel; front-passenger front air bag ② deploys in front of and above the glove box. They are deployed:

- in the event of certain frontal impacts
- if the system determines that air bag deployment can offer additional protection to that provided by the seat belt
- if the seat belt is fastened
- independently of other air bags in the vehicle

If the vehicle overturns, the front air bags are generally not deployed unless the system detects high vehicle deceleration in a longitudinal direction.

Your vehicle has adaptive, dual-stage front air bags. In the event of a collision, the air bag control unit evaluates the vehicle deceleration. When the first deployment threshold is reached, the front air bag is filled with enough gas to reduce the risk of injuries. The front air bag is fully deployed if a second deployment threshold is exceeded within a few milliseconds.

Vehicles with OCS (USA only): front-passenger front air bag deployment is also influenced by the passenger's weight category as identified by the Occupant Classification System (OCS) (> page 42).

Vehicles with OCS (USA only): the lighter the passenger side occupant, the higher the vehicle deceleration rate required for second

stage inflation of the front-passenger front air bag. In the second stage, the front air bags are inflated with the maximum amount of propellant gas available.

The air bags will not deploy in impacts which do not exceed the system's preset deployment thresholds. You will then be protected by the fastened seat belts.

**!** Vehicles with BabySmart™ (Canada only): do not place objects heavier than 20 lb (9 kg) on the front-passenger seat, as this could be interpreted as the seat being occupied. In the event of an accident, the restraint systems on the front-passenger side are deployed. Have restraint systems replaced that have been deployed.

The front-passenger front airbag will only deploy if:

- the system, based on the OCS weight sensor readings, detects that the front-passenger seat is occupied (USA only).
- the  **PASS AIR BAG OFF** indicator lamp in the center console is not lit, USA: (> page 42), Canada: (> page 48).
- the impact exceeds a preset deployment threshold.

## Side impact air bags

### **Warning**

Observe "Important safety instructions" (> page 38).

### **Warning!**

The pressure sensors for side impact air bag control are located in the doors. Do not modify any components of the doors or door trim panels including, for example, the addition of door speakers.

Improper repair work on the doors or the modification or addition of components to the doors create a risk of rendering the side impact air bags inoperative or causing unintended air bag deployment. Work on the doors must therefore only be performed by

qualified technicians. Contact an authorized Mercedes-Benz Center.

### **Warning!**

Only use seat covers which have been tested and approved by Mercedes-Benz for your vehicle model. Using other seat covers may interfere with or prevent the deployment of the side impact air bags. Contact an authorized Mercedes-Benz Center for availability.

When deployed, the side impact air bags offer additional protection for the thorax of the vehicle occupants on the side of the vehicle on which the impact occurs. However, they do not protect the:

- head
- neck
- arms

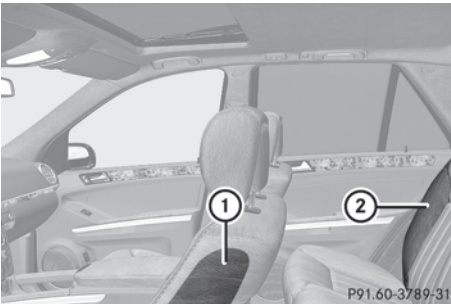

Front side impact air bags ① and rear side impact air bags ② deploy next to the outer seat cushions.

The side impact air bags are deployed:

- on the side on which an impact occurs
- at the start of an accident with a high rate of lateral vehicle deceleration or acceleration, e.g. in a side impact
- independently of seat belt use
- independently of the front air bags
- independently of the ETDs/belt buckle tensioners

The side impact air bags are generally not deployed if the vehicle overturns, unless the

system detects high vehicle deceleration or acceleration in a lateral direction and determines that they can offer additional protection to that provided by the seat belt. The side impact air bags are not deployed in side impacts which do not exceed the system's deployment threshold.

Vehicles with OCS (USA only): if the OCS detects that the front-passenger seat is not occupied and the front passenger seat belt is not fastened (the belt tongue is not engaged in the seat belt buckle), the side impact air bag on the front-passenger side will not deploy. The side impact air bag on the front-passenger side will deploy if the front passenger seat belt is fastened, regardless of whether the front-passenger seat is occupied or not.

**!** Vehicles with BabySmart™ (Canada only): do not place objects heavier than 20 lb (9 kg) on the front-passenger seat, as this could be interpreted as the seat being occupied. In the event of an accident, the restraint systems on the front-passenger side are deployed. Have restraint systems replaced that have been deployed.

## Window curtain air bags

### **Warning**

Observe "Important safety instructions" (▶ page 38).

The window curtain air bags enhance the level of protection for the head (but not chest or arms) of the vehicle occupants on the side of the vehicle on which the impact occurs.

The window curtain air bags are integrated into the side of the roof frame and deploy in the area extending from the front door (A-pillar) to the rear door (C-pillar).

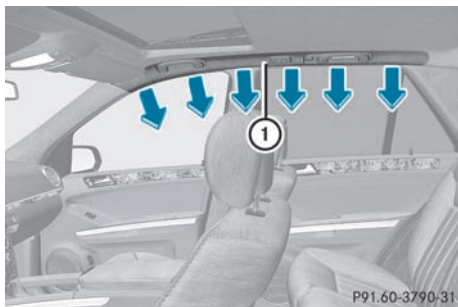



Window curtain air bags ① are deployed:

- on the side on which an impact occurs
- at the start of an accident with a high rate of lateral vehicle deceleration or acceleration, e.g. in a side impact
- regardless of whether the front-passenger seat is occupied
- if the vehicle overturns and the system determines that window curtain air bag deployment can offer additional protection to that provided by the seat belt
- independently of the front air bags

The window curtain air bags will not deploy in impacts which do not exceed the system's preset thresholds. You will then be protected by the fastened seat belts.

### Occupant classification system (OCS)

#### Operating principles of the Occupant Classification System

The OCS is standard equipment in the USA. OCS categorizes the occupant on the front-passenger seat by means of a weight sensor. The front-passenger front air bag is automatically deactivated for certain weight categories. The  **PASS AIR BAG OFF** indicator lamp shows you the current status. If the  **PASS AIR BAG OFF** indicator lamp lights up, the front-passenger front air bag is deactivated.

The system does not disable:

- the side impact air bag
- the window curtain air bag
- the Emergency Tensioning Device/belt buckle tensioner (ETD)

To be classified correctly, the front passenger must sit:

- with the seat belt properly fastened
- in a position that is as upright as possible with the back against the seat backrest
- with their feet on the floor

The OCS weight sensor is distorted if the occupant's weight is transferred to another object in the vehicle, e.g. by leaning on the armrest.

In addition, the occupant weight may appear to increase or decrease due to the following:

- objects hanging on the seat
- objects lodged underneath the seat
- objects lodged between the seat and the center console
- objects lodged between the seat and the door
- other passengers exerting weight on the seat
- objects applying pressure to the back of the seat



Make sure that the seat always has clearance in all directions.

If the front-passenger seat, the seat cover or the seat cushion are damaged, have the necessary repair work carried out at an authorized Mercedes-Benz Center.

For safety reasons, Mercedes-Benz recommends that you only use seat accessories which have been approved by Mercedes-Benz.

Both the driver and the front passenger should observe the  **PASS AIR BAG OFF** indicator lamp to determine whether or not the front passenger is positioned correctly.



### Warning!

If the  **PASS AIR BAG OFF** indicator lamp illuminates when an adult or someone larger than a small individual is in the front passenger seat, have the front passenger reposition himself or herself in the seat until the  **PASS AIR BAG OFF** indicator lamp goes out, or check whether objects are caught under or around the seat.

In the event of a collision, the air bag control unit will not allow front passenger front air bag deployment when the OCS has classified the front passenger seat occupant as weighting as much as or less than a typical 12-month-old child in a standard child restraint or if the front passenger seat is classified as being empty.

When the OCS senses that the front passenger seat occupant is classified as being up to or less than the weight of a typical 12-month-old child in a standard child restraint, the  **PASS AIR BAG OFF** indicator lamp will illuminate when the engine is started and remain illuminated, indicating that the front passenger front air bag is deactivated.

When the OCS senses that the front passenger seat is classified as being empty, the  **PASS AIR BAG OFF** indicator lamp will illuminate when the engine is started and remain illuminated, indicating that the front passenger front air bag is deactivated.

When the OCS senses that the front passenger seat occupant is classified as being heavier than the weight of a typical 12-month-old child seated in a standard child restraint or as being a small individual (such as a young teenager or a small adult), the  **PASS AIR BAG OFF** indicator lamp will illuminate for approximately 6 seconds when the engine is started and then, depending on occupant weight sensor readings from the seat, remain illuminated or go out. With the 

**PASS AIR BAG OFF** indicator lamp illuminated, the front passenger front air bag is deactivated. With the  **PASS AIR BAG OFF** indicator lamp out, the front passenger front air bag is activated.

When the OCS senses that the front passenger seat occupant is classified as an adult or someone larger than a small individual, the  **PASS AIR BAG OFF** indicator lamp will illuminate for approximately 6 seconds when the engine is started and then goes out, indicating that the front passenger front air bag is activated.

If the  **PASS AIR BAG OFF** indicator lamp is illuminated, the front passenger front air bag is deactivated and will not be deployed.

If the  **PASS AIR BAG OFF** indicator lamp is not illuminated, the front passenger front air bag is activated and will be deployed

- in the event of certain frontal impacts
- if impact exceeds a preset deployment threshold
- independently of the side impact air bags

If the front passenger front air bag is deployed, the rate of inflation will be influenced by

- the rate of relevant vehicle deceleration as assessed by the air bag control unit
- the front passenger's weight category as identified by the OCS

For further information, see "Air bag display messages" (> page 224).

### Warning!





Accident statistics show that children secured in the rear seats are safer than children secured in the front-passenger seat. For this reason, we strongly advise that you always secure children in the rear seats. Regardless of the seat position, children under 12 years must be secured correctly in a suitable infant or child restraint system or booster seat suitable for the size and weight of the child.

The infant or child restraint system must be correctly secured using the vehicle's seat belt, the seat belt and Top Tether belt or the lower anchorages and the Top Tether belt in

complete accordance with the child seat manufacturer's instructions.

Occupants, in particular children, must sit as upright as possible, fasten the seat belt correctly and use a suitable infant restraint system, child restraint system or booster seat suitable for the size and weight of the child.

Children can be killed or seriously injured by an inflating air bag. Observe the following important information if it is absolutely necessary to carry a child on the front-passenger seat:

- your vehicle is equipped with air bag technology designed to deactivate the passenger front air bag in your vehicle when the system senses the weight of a typical 12-month-old child or less along with the weight of a standard appropriate child restraint on the passenger seat.
- a child in a rear-facing child restraint on the passenger seat will be seriously injured or even killed if the passenger front air bag inflates in a collision which could occur under some circumstances, even with the air bag technology installed in your vehicle. The only way to completely rule out this risk is by making sure you never place a child in a rearward-facing child restraint system on the front-passenger seat. For this reason, we strongly advise that you always carry children in a rearward-facing child restraint system on a rear seat.
- if it is absolutely necessary to install a rearward-facing child restraint system on the front-passenger seat, make sure the  **PASS AIR BAG OFF** indicator lamp is illuminated, indicating that the front-passenger front air bag is disabled. If the  **PASS AIR BAG OFF** indicator lamp does not light up or goes out when the child restraint system is installed, check the anchorages of the restraint system. Check the  **PASS AIR BAG OFF** indicator lamp regularly while driving to ensure that the  **PASS AIR BAG OFF** indicator lamp is illuminated. If the  **PASS AIR BAG OFF** indicator

lamp lights up or remains out, you may only carry a child on the front-passenger seat once the system has been repaired.

A child in a rear-facing child restraint on the passenger seat will be seriously injured or even killed if the passenger front air bag inflates.

- when securing a child in a child restraint system on the front-passenger seat, you must:
  - move the front-passenger seat as far back as possible
  - use a child restraint system that is suitable for the age, size and weight of the child
  - observe the manufacturer's installation instructions in order to install and secure the child restraint system correctly.
- for children larger than the typical 12-month-old child, the passenger front air bag is activated.

Deployment of the driver front air bag does not mean that the front-passenger front air bag also should have deployed. The OCS may have determined:

- that the seat was empty or occupied by a person with a weight up to or less than that of a typical 12 month-old child seated in a standard child restraint
- that the seat was occupied by a small person (e.g. a young teenager or a small adult) or a child that weighs more than a typical 12 month old child in a child restraint system

These are examples of when OCS disables the front-passenger front air bag. This occurs even though the impact fulfills the criteria for deployment of the driver's front air bag.



If the key has been removed from the ignition lock or is in position **0**, indicator lamp

 **PASS AIR BAG OFF** **1** does not light up.

### **Warning**

If the red **SRS** SRS warning lamp in the instrument cluster and the  **PASS AIR BAG OFF** indicator lamp light up simultaneously, OCS is malfunctioning. The front-passenger front air bag is disabled in this case. Have the system checked as soon as possible by qualified technicians. Contact an authorized Mercedes-Benz Center.

Only have the seat repaired or replaced at an authorized Mercedes-Benz Center.

In order to ensure proper operation of the air bag system and OCS:

- do not place any objects with a total weight of more than 4.4 lb(2 kg) in the parcel net on the back of the front-passenger seat. OCS may otherwise be unable to correctly assess the occupant's weight category.
- do not place any objects under or near the front-passenger seat.
- do not hang or fasten any objects on the seats.
- do not store any objects, such as books, between the front-passenger seat and the center console or the front-passenger door.
- do not slide the front-passenger seat backwards against any hard objects.
- sit with the seat belt fastened correctly and in a position that is as upright as possible with your back against the backrest.

- while seated, an occupant should not position him/herself in such a way as to cause the occupant's weight to be lifted from the seat bottom as this may result in the OCS being unable to correctly approximate the occupant's weight category.
- read and observe all warnings in this chapter.

### **System self-test**

The  **PASS AIR BAG OFF** indicator lamp illuminates when you:

- turn the SmartKey to position **1** or **2** in the ignition lock
- press the KEYLESS-GO Start-Stop button once or twice

If an adult occupant is properly sitting on the passenger seat and the OCS classifies the occupant as an adult, the  **PASS AIR BAG OFF** indicator lamp illuminates and goes out again after approximately 6 seconds.

If the seat is not occupied and the OCS classifies the front-passenger seat as being unoccupied, the  **PASS AIR BAG OFF** indicator lamp will illuminate and not go out.

### **Warning!**

If the  **PASS AIR BAG OFF** indicator lamp does not illuminate, the system is not functioning. You must contact an authorized Mercedes-Benz Center before seating any child on the front passenger seat.

For more information, see "Problems with the occupant classification system" (▷ page 47).

### **Warning**

Never place anything between seat cushion and child seat (e.g. a pillow), since it reduces the effectiveness of the OCS. The underside and rear side child restraint system must be placed entirely on the seat cushion and the backrest of the front-passenger seat backrest.

If necessary, adjust the tilt of the passenger seat backrest.

An incorrectly mounted child seat could cause injuries to the child in case of an accident, instead of increasing protection for the child.



Follow the manufacturer's instructions for installation of child restraint systems.

## Problems with the occupant classification system

Problem	Possible causes/consequences and ► Solutions
<p>USA only: The  <b>PASS AIR BAG OFF</b> indicator lamp illuminates and remains illuminated when the weight of a typical adult or an individual that is the size of a typical adult has been detected on the passenger seat; the system then determines the occupant cannot be a child.</p>	<p>The OCS is malfunctioning.</p> <ul style="list-style-type: none"> <li>► Have the OCS checked as soon as possible at an authorized Mercedes-Benz Center.</li> <li>► Read and observe the additional display messages in the multifunction display (► page 224).</li> </ul>

### Warning

If the  **PASS AIR BAG OFF** indicator lamp illuminates and remains illuminated when the weight of a typical adult or someone larger than a small individual has been detected on the passenger seat, the system then determines the occupant cannot be a child. Do not allow any occupant to use the passenger seat until the system has been repaired.

Problem	Possible causes/consequences and ► Solutions
<p>The  <b>PASS AIR BAG OFF</b> indicator lamp does not illuminate and/or does not remain illuminated when the weight of a typical 12-month-old child in a standard child restraint or less/unoccupied child restraint has been detected on the front-passenger seat.</p>	<p>The OCS is malfunctioning.</p> <ul style="list-style-type: none"> <li>► Make sure there is nothing between the seat cushion and the child seat.</li> <li>► Check the installation of the child restraint system.</li> <li>► Make sure there are no objects applying additional weight onto the seat.</li> <li>► Make sure there are no objects applying additional weight onto the seat. Head restraints that press against the roof or books that are behind or trapped between the seat, for example, apply force to the seat. OCS senses such forces as additional weight.</li> <li>► If the  <b>PASS AIR BAG OFF</b> indicator lamp does not illuminate, have the OCS checked as soon as possible at an authorized Mercedes-Benz Center. Do not transport a child on the front-passenger seat until the OCS has been repaired.</li> <li>► Read and observe the additional display messages in the multifunction display (► page 224).</li> </ul>

### Warning

If the  **PASS AIR BAG OFF** indicator lamp does not illuminate or remains out with the weight of a typical 12-month-old child in a standard child restraint or less, or is unoccupied, on the front-passenger seat, do not transport a child on the front-passenger seat until the system has been repaired.

## BabySmart™ air bag deactivation system

### How the air bag deactivation system functions

The BabySmart™ system is standard equipment in Canada.

### Warning

Accident statistics show that children secured in the rear seats are safer than children secured in the front-passenger seat. For this reason, Mercedes-Benz strongly advises that you always secure children in the rear seats. Regardless of the seat position, children under 12 years must be secured correctly in a suitable infant or child restraint system or booster seat suitable for the size and weight of the child.

Secure the child restraint system with:

- the seat belt of the vehicle
- the seat belt and a Top Tether belt
- the ISOFIX child seat securing system and a Top Tether belt.





The child restraint system must be installed and secured correctly, observing the manufacturer's installation instructions.

Occupants, in particular children, must sit as upright as possible, fasten the seat belt correctly and use a suitable infant restraint system, child restraint system or booster seat suitable for the size and weight of the child.

Children can be killed or seriously injured by an inflating air bag. Observe the following important information if it is necessary to carry a child on the front-passenger seat:

- Canada only: children under 12 years may only sit in the front-passenger seat if they

are seated in a child restraint system which is compatible with BabySmart™ and approved by Mercedes-Benz. When the child restraint system is installed correctly, the front-passenger front air bag is disabled in conjunction with the BabySmart™ system installed in the vehicle. If the front-passenger front air bag is deployed in the event of a collision, it could hit the child. This could lead to serious or fatal injuries.

- a child in a rear-facing child restraint on the passenger seat will be seriously injured or even killed if the passenger front air bag inflates in a collision which could occur under some circumstances, even with the air bag technology installed in your vehicle. The only way to completely rule out this risk is by making sure you never place a child in a rearward-facing child restraint system on the front-passenger seat. For this reason, we strongly advise that you always carry children in a rearward-facing child restraint system on a rear seat.
- if it is necessary to install a BabySmart™-compatible rearward-facing child restraint system on the front-passenger seat, make sure the  **PASS AIR BAG OFF** indicator lamp is illuminated. This indicates that the front-passenger front air bag is disabled. If the  **PASS AIR BAG OFF** indicator lamp does not light up or goes out when the child restraint system is installed, check the anchorages of the restraint system. Check the  **PASS AIR BAG OFF** indicator lamp regularly while driving to ensure that the  **PASS AIR BAG OFF** indicator lamp is illuminated. If the  **PASS AIR BAG OFF** indicator lamp goes out or remains out, you may only



carry a child on the front-passenger seat once the system has been repaired.

A child in a rear-facing child restraint on the passenger seat will be seriously injured or even killed if the passenger front air bag inflates.

- when securing a child in a front-facing child restraint system on the front-passenger seat, you must:
  - move the front-passenger seat as far back as possible
  - use a child restraint system that is suitable for the age, size and weight of the child
  - observe the manufacturer's installation instructions in order to install and secure the child restraint system correctly.

### **Warning**

When using a BabySmart™-compatible child restraint system on the front-passenger seat, the front-passenger front air bag is only disabled if the  **PASS AIR BAG OFF** indicator lamp is illuminated.

Always check the  **PASS AIR BAG OFF** indicator lamp if you are using a BabySmart™-compatible child restraint system on the front-passenger seat. If the  **PASS AIR BAG OFF** indicator lamp does not light up or goes out when the child restraint system is installed, check the anchorages of the restraint system. If the  **PASS AIR BAG OFF** indicator lamp remains out, do not use the BabySmart™ child restraint system to carry a child on the front-passenger seat until the system has been repaired.

### **Warning**

The BabySmart™ air bag disabling system ONLY works with specially adapted child restraint systems. It does not work with child restraint systems that are not compatible with BabySmart™.

Never place anything between the seat cushion and the child restraint system (e.g. a cushion), as this reduces the effectiveness of

the BabySmart™ air bag deactivation system. The underside of the child restraint system must lie against the seat cushion of the front-passenger seat. In the event of an accident, an incorrectly installed child restraint system could injure the child instead of offering protection.

Observe the manufacturer's instructions when installing special child restraint systems.



Special child restraint systems which are compatible with BabySmart™ are necessary for deactivating the front-passenger front air bag. When the special child restraint system which is compatible with BabySmart™ is installed correctly and is recognized by the sensor system in the front-passenger seat, the front-passenger front air bag is deactivated. In this case,  **PASS AIR BAG OFF** indicator lamp ① illuminates. If you have any questions regarding the special child restraint systems which are compatible with BabySmart™, consult an authorized Mercedes-Benz Center.

If the key has been removed from the ignition lock or is in position **0**, indicator lamp  **PASS AIR BAG OFF** ① does not light up.

The system does not disable:

- the side impact air bag
- the window curtain air bag
- the Emergency Tensioning Device/belt buckle tensioner (ETD)

## System self-test

The  **PASS AIR BAG OFF** indicator lamp illuminates when you:



- turn the SmartKey to position **1** or **2** in the ignition lock
- on vehicles with KEYLESS-GO, press the Start-Stop button once or twice.

The  **PASS AIR BAG OFF** indicator lamp goes out again after approximately six seconds.

If the  **PASS AIR BAG OFF** indicator lamp does not illuminate or is lit continuously, the system is malfunctioning. Before transporting a child on the front-passenger seat, have the BabySmart™ system checked at an authorized Mercedes-Benz Center.

For more information, see "Problems with the air bag deactivation system" section (▷ page 51)

### **Warning!**

Do not place powered-on laptops, mobile phones, electronic tags such as those used in ski passes and like electronic devices on the front passenger seat. Signals from such devices may interfere with the BabySmart™ air bag deactivation system. Such signal interference may cause the  **PASS AIR BAG OFF** indicator lamp not to come on during self-test. The SRS indicator lamp **SRS** and/or the  **PASS AIR BAG OFF** indicator lamp could be continuously lit, indicating that the system is not functioning. The front passenger front air bag could deploy inadvertently or fail to deploy in an accident.

## Problems with the air bag deactivation system

Problem	Possible causes/consequences and ► Solutions
Canada only: The  indicator lamp is illuminated constantly.	<p>A special BabySmart™ compatible child restraint system is installed on the front-passenger seat.</p> <p>The front-passenger front air bag is thus deactivated.</p> <p>A BabySmart™-compatible child restraint system is not installed on the front-passenger seat. The BabySmart™ system is malfunctioning.</p> <p>► Have the BabySmart™ system checked as soon as possible at an authorized Mercedes-Benz Center.</p>

### Warning

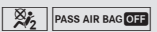
If the  indicator lamp illuminates and remains illuminated when the weight of a typical adult or someone larger than a small individual has been detected on the passenger seat, the system then determines the occupant cannot be a child. Do not allow any occupant to use the passenger seat until the system has been repaired.

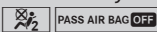
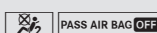
Problem	Possible causes/consequences and ► Solutions
Canada only: The  indicator lamp does not illuminate or does not remain illuminated with a BabySmart™ compatible child restraint system properly installed on the front-passenger seat.	<p>The BabySmart™ system is malfunctioning.</p> <p>► Make sure there is nothing between the seat cushion and the child restraint system.</p> <p>► Check the installation of the child restraint system.</p> <p>► If the  indicator lamp does not illuminate, have the BabySmart™ system checked as soon as possible at an authorized Mercedes-Benz Center.</p> <p>Do not transport a child on the front-passenger seat until the BabySmart™ system has been repaired.</p>

## PRE-SAFE® system

### Warning!

The PRE-SAFE® system is intended to reduce the effects of an accident on vehicle occupants who are wearing their seat belt properly. Despite your vehicle being equipped with the PRE-SAFE® system, the possibility of personal injuries occurring as a result of an accident cannot be eliminated. Therefore, always drive carefully and adjust your driving

to the prevailing road, weather, and traffic conditions.

PRE-SAFE® takes pre-emptive measures to protect you in certain hazardous situations.

PRE-SAFE® intervenes:

- in emergency braking situations, if the BAS Brake Assist System intervenes
- in critical driving situations, e.g. if the vehicle understeers or oversteers severely when exceeding physical limits or in case

of having to swerve to avoid an obstacle at a speed above 85 mph (140 km/h).

PRE-SAFE® takes the following measures depending on the hazardous situation detected:

- the front seat belts are pre-tensioned.
- on vehicles with memory functions: the front-passenger seat is adjusted if it is in an unfavorable position under accident conditions.
- if the vehicle skids, the side windows are closed so that only a small gap remains.
- on vehicles with sliding sunroof: if the vehicle skids, the sliding sunroof closes so that only a small gap remains.

If the hazardous situation passes without resulting in an accident, PRE-SAFE® slackens the belt pretensioning. All settings made by PRE-SAFE® can then be reversed.

If the seat belts are not released:

- ▶ Move the backrest or the seat back slightly until the belt pretensioning is reduced. The locking mechanism releases.

#### Warning

Make sure that nobody can become trapped as you adjust the seat.

- ❗ Make sure that there are no objects in the footwell or behind the seats when resetting the seats. There is a risk that the seats and/or the objects could be damaged.

More information about belt adjustment, a convenience function integrated into PRE-SAFE®, can be found in the "Belt adjustment" section (▷ page 56).

### NECK-PRO head restraints

The NECK-PRO head restraints increase protection to the driver's and front-passenger's head and neck. To this end, the head restraints on the driver's and front-passenger seats are moved forwards and upwards in the event of a rear-end collision of

a certain severity. This provides better head support.

#### Warning

Do not secure any objects (e.g. coat hangers) on the NECK-PRO head restraints. Otherwise, the NECK-PRO head restraints may not function properly, or in the event of a rear-end collision may not be able offer the level of protection they are designed to provide.

#### Warning

Only use seat covers/head restraint covers that have been tested and approved by Mercedes-Benz for your model.

Using seat covers and head restraint covers other than those recommended can prevent/impair the triggering of NECK-PRO head restraints and/or the deployment of side impact air bags in the front.

Contact an authorized Mercedes-Benz Center for availability.

If the NECK-PRO head restraints have been triggered in an accident, you must reset the NECK-PRO head restraints on the driver's and front-passenger seat (▷ page 53). Otherwise, the additional protection will not be available in the event of another rear-end collision. You can recognize when NECK-PRO head restraints have been triggered by the fact that they have moved forwards and can no longer be adjusted.

#### Warning!

For your protection, drive only with properly positioned head restraints.

Adjust the head restraint so that it is as close to the head as possible and the center of the head restraint supports the back of the head at eye level. This will reduce the potential for injury to the head and neck in the event of an accident or similar situation.

## Resetting triggered NECK-PRO head restraints

### **Warning!**

For reasons of safety, have the NECK-PRO head restraints checked after a rear end collision at an authorized Mercedes-Benz Center.

### **Warning**

If you press the NECK-PRO head restraint cushion backwards, make sure that your fingers are not trapped between the cushion and the cover. Failure to observe could result in injuries.

- i** Resetting the NECK-PRO head restraints requires a lot of strength. If you have difficulty resetting the NECK-PRO head restraints, have this work carried out at a qualified specialist workshop, e.g. an authorized Mercedes-Benz Center.

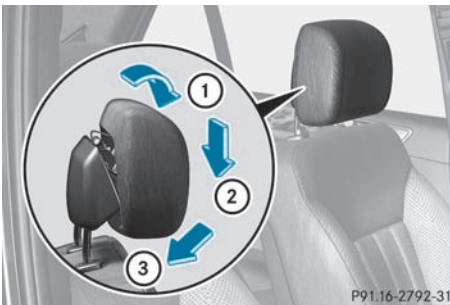

- ▶ Tilt the top of the NECK-PRO head restraint cushion forwards in the direction of arrow ①.
- ▶ Push the NECK-PRO head restraint cushion down as far as it will go in the direction of arrow ②.
- ▶ Firmly push the NECK-PRO head restraint cushion backwards in the direction of arrow ③ until it engages.
- ▶ Repeat this procedure for the second NECK-PRO head restraint.

## Seat belts

### Important safety guidelines

The use of infant or child restraint systems is required by law in all 50 states, the District of Columbia, the U.S. territories and all Canadian provinces.

Even if this is not the case, all vehicle occupants should have their seat belts fastened when the vehicle is in motion.

- i** See "Children in the vehicle" (> page 58) for further information on infants and children traveling in the vehicle as well as on child restraint systems.

### **Warning!**

Always fasten your seat belt before driving off. Always make sure all of your passengers are properly restrained. You and your passengers should always wear seat belts.

Failure to wear and properly fasten and position your seat belt greatly increases your risk of injuries and their likely severity in an accident.

If you are ever in an accident, your injuries can be considerably more severe without your seat belt properly buckled. Without your seat belt buckled, you are much more likely to hit the interior of the vehicle or be ejected from it. You can be seriously injured or killed.

In the same crash, the possibility of injury or death is lessened if you are properly wearing your seat belt. The air bags can only protect as intended if the occupants are properly wearing their seat belts.

### **Warning**

Never ride in a moving vehicle with the seat backrest in an excessively reclined position as this can be dangerous. You could slide under the seat belt in a collision. If you slide under it, the seat belt would apply force at the abdomen or neck. That could cause serious or even fatal injuries. The seat backrest and seat belt provide the best restraint when the wearer is in a position that is as upright as

possible and the seat belt is properly positioned on the body.

### Warning

Never let more people ride in the vehicle than there are seat belts available. Make sure everyone riding in the vehicle is correctly restrained with a separate seat belt. Never use a seat belt for more than one person at a time.

### Warning

Damaged seat belts or seat belts that have been subjected to stress in an accident must be replaced and their anchoring points must also be checked.

Only use seat belts which have been approved by Mercedes-Benz.

Do not make any modifications to the seat belts. This can lead to unintended activation of the ETDs or to their failure to activate when necessary.

Do not bleach or dye seat belts as this may severely weaken them. In a crash they may not be able to provide adequate protection.

Have all work carried out only by qualified technicians. Contact an authorized Mercedes-Benz Center.

## Correct use of the seat belt

### Warning

#### USE SEAT BELTS PROPERLY

- Seat belts can only protect when used properly. Never wear seat belts in any other way than as described in this section, as that could result in serious injuries in case of an accident.
- Each occupant should wear their seat belt at all times, because seat belts help reduce the likelihood of and potential severity of injuries in accidents, including rollovers. The integrated restraint system includes SRS (driver's front air bag, front-passenger front air bag, side impact air bags, window

curtain air bags for door windows), Emergency Tensioning Devices, seat belt force limiters, and front seat knee bolsters.

The system is designed to enhance the protection offered to properly belted occupants in certain frontal (front air bags and ETDs) and side (side impact air bags, window curtain air bags, and ETDs) impacts which exceed preset deployment thresholds and in certain rollovers (window curtain air bags and ETDs).

- Never wear the shoulder belt under your arm, across your neck or not routed across your shoulder. In a frontal crash, your body would move too far forward. That would increase the chance of head and neck injuries. The seat belt would also apply too much force to the ribs or abdomen, which could severely injure internal organs such as your liver or spleen.

Adjust the seat belt so that the shoulder section is located as close as possible to the middle of the shoulder. It should not touch the neck. Never pass the shoulder portion of the seat belt under your arm. For this purpose, you can adjust the height of the seat belt outlet.

- Position the lap belt as low as possible on your hips and not across the abdomen. If the lap belt is positioned across your abdomen, it could cause serious injuries in a crash.
- Never wear seat belts over rigid or breakable objects in or on your clothing, such as eyeglasses, pens, keys etc., as these might cause injuries.
- Make sure the seat belt is always routed snugly. Take special care of this when wearing loose clothing.
- Never use a seat belt for more than one person at a time. Do not fasten a seat belt around a person and another person or other objects at the same time.
- Seat belts should not be worn twisted. In a crash, you would not have the full width of the seat belt to distribute impact forces.

The twisted seat belt against your body could cause injuries.

- Pregnant women should also always use a lap-shoulder belt. The lap belt portion should be positioned as low as possible on the hips to avoid any possible pressure on the abdomen.
- Place the seat backrest in a position that is as upright as possible.
- Check your seat belt during travel to make sure it is properly positioned.
- Never place your feet on the instrument panel, dashboard, or on the seat. Always keep both feet on the floor in front of the seat.
- When using a seat belt to secure infant restraints, toddler restraints, or children in booster seats, always follow the child seat manufacturer's instructions.

#### **Warning**

Do not pass seat belts over sharp edges. They could tear.

Do not allow the seat belt to get caught in the door or in the seat adjustment mechanism. This could damage the seat belt.

Never attempt to make modifications to seat belts. This could impair the effectiveness of the seat belts.

### Fastening seat belts

#### **Warning**

According to accident statistics, children are safer when properly restrained on the rear seats than on the front-passenger seat. Thus, we strongly recommend that children be placed in the rear seat whenever possible. Regardless of seating position, children 12 years old and under must be seated and properly secured in an appropriately sized child restraint system or booster seat recommended for the size and weight of the child. For additional information, see the "Children in the vehicle" section.

A child's risk of serious or fatal injuries is significantly increased if the child restraints are not properly secured in the vehicle and/or the child is not properly secured in the child restraint.

#### **Warning**

Canada only: children 12 years old and under may ride on the front seat if a BabySmart™ compatible child restraint system is installed on the front-passenger seat. Use only Mercedes-Benz approved BabySmart™ compatible child restraint systems. A BabySmart™ compatible child restraint system will deactivate the front-passenger front air bag when installed properly. The front-passenger front air bag will not be deactivated if the child restraint systems that are installed are not BabySmart™ compatible or if BabySmart™ compatible child restraint systems are not installed correctly. If the front-passenger front air bag is deployed in a collision, the child could be struck by the air bag. This could lead to serious or fatal injury.

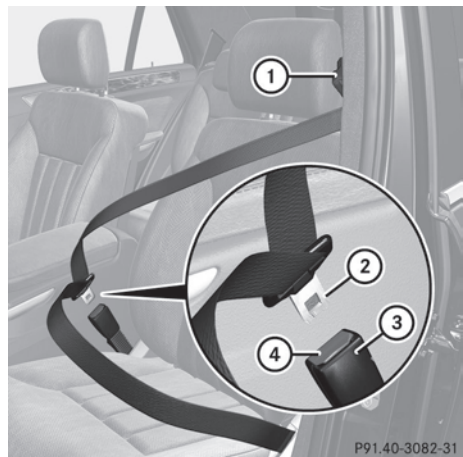

P91.40-3082-31

- ▶ Adjust the seat and move the backrest to an almost vertical position (▷ page 92).
- ▶ Pull the seat belt smoothly through belt sash guide ①.

- ▶ Without twisting it, place the shoulder section of the seat belt over the center of the shoulder and the lap section across the hips.
- ▶ Engage belt tongue ② in buckle ③.  
Seat belt adjustment: if necessary, the driver's and front-passenger seat belts automatically adjust to the upper body (▷ page 56).
- ▶ If necessary, adjust the seat belt to the appropriate height (▷ page 56).
- ▶ If necessary, pull upwards on the shoulder section of the seat belt to tighten the belt across your body.

All seat belts in the vehicle, except the driver's seat belt, are equipped with a special seat belt retractor to secure child restraint systems properly. For further information on "Special seat belt retractors", see (▷ page 61).

For more information about releasing the seat belt with release button ④, see "Releasing seat belts" (▷ page 56).

### Seat belt adjustment

The belt adjustment function adjusts the driver's and front-passenger seat belt to the upper body of the occupants. The belt strap is tightened slightly when:

- you engage the belt tongue in the belt buckle and you then turn the SmartKey to position **2** in the ignition lock.
- the SmartKey is in position **2** in the ignition lock and you then engage the belt tongue in the buckle.

The seat-belt adjustment will apply a certain tightening force if any slack is detected between the occupant and the seat belt. Do not hold on to the seat belt tightly while it is adjusting. You can switch the belt adjustment on and off in the on-board computer (▷ page 218).

### Seat belt outlet height adjustment

You can adjust the seat belt height on the driver's seat and the front-passenger seat.



Adjust the belt to a height that allows the upper part of the seat belt to be routed across the center of your shoulder.

- ▶ **To raise:** slide the belt sash guide upwards. The belt sash guide engages in various positions.
- ▶ **To lower:** press and hold belt sash guide release ①.
- ▶ Slide the belt sash guide downwards.
- ▶ Release belt sash guide release ① and make sure that the belt sash guide has engaged.

### Releasing seat belts



- ▶ Press release button ④ (▷ page 55) and guide belt tongue ② (▷ page 55) back towards belt sash guide ① (▷ page 55).
- ❗ Make sure that the seat belt is fully rolled up. Otherwise, the seat belt or belt tongue will be trapped in the door or in the seat mechanism. This could damage the door, the door trim panel and the seat belt. Damaged seat belts can no longer fulfill their protective function and must be replaced. Consult an authorized Mercedes-Benz Center.

## Belt warning for driver and front passenger

Regardless of whether the driver's and front-passenger seat belts have already been fastened, the  seat belt warning lamp lights up for six seconds each time the engine is started. It then goes out once the driver and the front passenger have fastened their seat belts.

If the driver's seat belt is not fastened after the engine is started, an additional warning tone will sound. The warning tone goes out after approximately six seconds or once the driver's seat belt is fastened.

If after six seconds the driver or front-passenger have not fastened their seat belts and the doors are closed:

- the  seat belt warning lamp remains illuminated as long as either the driver's or front-passenger seat belt is not fastened.
- if the vehicle speed once exceeds 15 mph (25 km/h), the  seat belt warning lamp lights up. Additionally, a warning tone will sound with increasing intensity for a maximum of 60 seconds or until the driver's and front-passenger seat belt are fastened.

If the driver/front passenger unfasten their seat belt while the vehicle is in motion, the  seat belt warning lamp lights up and a warning tone sounds again.

The warning tone ceases even if the driver or front passenger have still not fastened their seat belt after 60 seconds. The  seat belt warning lamp stops flashing but continues to be illuminated.

After the vehicle has come to a standstill, the warning tone is reactivated and the  seat belt warning lamp flashes again if the vehicle speed has exceeded 15 mph (25 km/h).

The  seat belt warning lamp only goes out if:

- both the driver and the front passenger have fastened their seat belts

or

- the vehicle is stationary and a door is open

**i** For more information on the  seat belt warning lamp, see "Indicator and warning lamps in the instrument cluster, seat belt" (▷ page 248).

## Emergency Tensioning Devices and seat belt force limiters

The front seat belts and the outer seat belts in the rear are equipped with ETDs and belt force limiters. In addition, the front seat belts are installed with belt buckle tensioners.

**!** If the front-passenger seat is not occupied, do not engage the seat belt tongue in the buckle on the front-passenger seat. Otherwise, the Emergency Tensioning Device/belt buckle tensioner could be triggered in the event of an accident.

ETDs/belt buckle tensioners tighten the seat belts in an accident, pulling them close against the body.

ETDs/belt buckle tensioners do not correct incorrect seat positions or incorrectly fastened seat belts.

ETDs do not pull vehicle occupants back towards the backrest.

Seat belt force limiters, when activated, are employed to help reduce the force exerted by the seat belts on occupants during a crash.

The front belt force limiters are synchronized with the front air bags, which take on a part of the deceleration force. Thus, the force exerted on the occupant is distributed over a greater area.

The ETDs/belt buckle tensioners can only be activated when:

- the ignition is switched on
- the restraint systems are operational; see "SRS warning lamp" (▷ page 36)

- the belt tongue is engaged in the buckle on each of the three-point seat belts in the front
- the front-passenger seat is occupied and the belt tongue is engaged in the buckle on the front-passenger side.

The ETDs on the outside seats in the rear compartment are triggered independently of the lock status of the seat belts.

The ETDs are triggered depending on the type and severity of an accident:

- in the event of a head-on or rear-end collision if the vehicle decelerates or accelerates rapidly in a longitudinal direction during the initial stages of the impact
- in the event of a side impact, on the side opposite the impact if the vehicle decelerates or accelerates rapidly in a lateral direction
- in certain situations if the vehicle overturns and the system determines that it can provide additional protection.

If the ETDs/belt buckle tensioners are triggered, you will hear a bang and a small amount of powder may also be released. Only in rare cases will the bang affect your hearing. The powder that is released generally does not constitute a health hazard. The **SRS** SRS warning lamp lights up.

- If the belt buckle tensioners have been triggered on the front seats, the buckle will be pulled down and will be almost flush with the upper edge of the seat. The **SRS** SRS warning lamp is lit.

#### Warning

The belt buckle tensioners on the front seats only function if the belt buckles can be pulled down unobstructed. They must not be restricted in any way. Therefore, do not grab the belt buckles and do not place any objects under the belt buckles. Otherwise, the tensioning of the belt by the buckle is restricted or will not function, and will not provide any additional protection.

#### Warning

Pyrotechnical ETDs/belt buckle tensioners that were activated must be replaced.

For your safety, when disposing of the pyrotechnic ETDs/belt buckle tensioners always follow our safety instructions. These instructions are available from any authorized Mercedes-Benz Center.

The PRE-SAFE® system is equipped with electrically reversible pre-tensioners that do not need replacing after deployment.

## Children in the vehicle

### Important safety guidelines

#### Warning

When leaving the vehicle, always remove the SmartKey from the ignition lock. Always take the SmartKey with you and lock the vehicle. Do not leave children unattended in the vehicle, even if they are secured in a child restraint system, or with access to an unlocked vehicle. A child's unsupervised access to a vehicle could result in an accident and/or serious personal injury. The children could:

- injure themselves on parts of the vehicle
- be seriously or fatally injured through excessive exposure to extreme heat or cold
- injure themselves or cause an accident with vehicle equipment that can be operated even if the SmartKey is removed from the ignition lock or removed from the vehicle, such as seat adjustment, steering wheel adjustment, or the memory function

If children open a door, they could injure other persons or get out of the vehicle and injure themselves or be injured by following traffic.

Do not expose the child restraint system to direct sunlight. The child restraint system's metal parts, for example, could become very hot, and the child could be burned on these parts.

**⚠ Warning!**

Do not carry heavy or hard objects in the passenger compartment or trunk unless they are firmly secured in place.

Unsecured or improperly positioned cargo increases a child's risk of injury in the event of

- strong braking maneuvers
- sudden changes of direction
- an accident

If an infant or child is traveling in the vehicle:

- ▶ Secure the child using an infant or child restraint system appropriate to the age and weight of the child.
- ▶ Make sure that the infant or child is properly secured at all times while the vehicle is in motion.

**Child restraint systems****Important safety guidelines****⚠ Warning**

Observe "Important safety instructions" (> page 58).

We recommend all infants and children be properly restrained using the child restraint systems at all times while the vehicle is in motion.

The use of infant or child restraints is required by law in all 50 states, the District of Columbia, the U.S. territories and all Canadian provinces.

Infants and small children should always be seated in an infant or child seat restraint system appropriate for the size and weight of the child. They must be properly secured in accordance with the manufacturer's installation instructions for the infant or child seat restraint system. All infant and child seat restraint systems must comply with the US Federal Motor Vehicle Safety Standards 213

and 225 and Canadian Motor Vehicle Safety Standards 213 and 210.2.

A statement by the child restraint manufacturer of compliance with these standards can be found on the instruction label on the child restraint system. You will also find the statement in the instruction manual provided with the child restraint system.

When using an infant restraint system, child restraint system or booster seat, make sure to carefully read and follow all manufacturer's instructions for installation and use.

Please read the warning labels affixed to the interior of the vehicle or to the infant restraint system or child restraint system.

**⚠ Warning**

According to accident statistics, children are safer when properly restrained on the rear seats than on the front-passenger seat. Thus, we strongly recommend that children be placed in the rear seats whenever possible. Regardless of seating position, children 12 years old and under must be seated and properly secured in an appropriately sized child restraint system or booster seat recommended for the size and weight of the child.





The infant or child restraint system must be properly secured with the vehicle's seat belt, the seat belt and Top Tether strap, or lower anchors and Top Tether strap, fully in accordance with the child seat manufacturer's instructions.

Occupants, especially children, should always sit as upright as possible, wear the seat belt properly and use an appropriately sized child restraint system or booster seat recommended for the size and weight of the child.

Children can be killed or seriously injured by an inflating air bag. Note the following important information when circumstances require you to place a child in the front-passenger seat:

- USA only: Your vehicle is equipped with air bag technology that is designed to deactivate the front-passenger front air bag, when the system on the front-passenger seat detects the weight of a typical 12-month old child in a standard child restraint.
- USA only: Children that weigh more than a typical 12-month old child, the front-passenger front air bag may be activated/deactivated. Always make sure that the  indicator lamp is illuminated indicating that the front-passenger front air bag is deactivated.
- Canada only: Children 12 years old and under may ride on the front seat if a BabySmart™ compatible child restraint system is installed on the front-passenger seat. Use only Mercedes-Benz approved BabySmart™ compatible child restraint systems. A BabySmart™ compatible child restraint system will deactivate the front-passenger front air bag when installed correctly. The front-passenger front air bag will not be deactivated if the child restraint systems that are installed are not BabySmart™ compatible or if BabySmart™ compatible child restraint systems are not installed correctly. If the front-passenger front air bag is deployed, the child could be killed when it inflates in a crash. This could lead to serious or fatal injury.
- A child in a rear-facing child restraint on the passenger seat will be seriously injured or even killed if the passenger front air bag inflates in a collision which could occur under some circumstances, even with the air bag technology installed in your vehicle. The only means to eliminate this risk completely is never to place a child in a rear-facing child restraint in the front seat.

We therefore strongly recommend that you always place a child in a rear-facing child restraint on the rear seat.

- If you must install a rear-facing child restraint on the front-passenger seat because circumstances require you to do so, make sure the  indicator lamp is illuminated, indicating that the front-passenger front air bag is deactivated. Should the  indicator lamp not illuminate or go out while the restraint is installed, please check installation. Periodically check the  indicator lamp while driving to make sure that the  indicator lamp is illuminated. If the  indicator lamp goes out or remains out, do not transport a child on the passenger seat until the system has been repaired.
- A child in a rear-facing child restraint on the passenger seat will be seriously injured or even killed if the passenger front air bag inflates.
- If you place a child in a forward-facing child restraint on the passenger seat:
    - move the seat as far back as possible
    - use the proper child restraint recommended for the age, size and weight of the child
    - secure child restraint with the vehicle's seat belt according to the child seat manufacturer's instructions
  - For children larger than the typical 12-month-old child, the passenger front air bag may or may not be activated.

### Warning

Infants and small children should never share a seat belt with another occupant. During an accident, they could be crushed between the occupant and seat belt.

A child's risk of serious or fatal injuries is significantly increased if the child restraints are not properly secured in the vehicle and/

or the child is not properly secured in the child restraint.

Children too big for a toddler restraint must ride in seats using regular seat belts. Position the shoulder belt across the chest and shoulder, not face or neck. A booster seat may be necessary to achieve proper seat belt positioning for children over 41 lb (18 kg) until they reach a height where a lap/shoulder belt fits properly without a booster.

When the child restraint is not in use, remove it from the vehicle or secure it with the seat belt to prevent the child restraint from becoming a projectile in the event of an accident.

### Special seat belt retractor

#### Warning

Observe "Important safety instructions" (▷ page 58).

All seat belts in the vehicle, except the driver's seat belt, are equipped with a special seat belt retractor. The activated special seat belt retractor ensures that the seat belt cannot slacken after being fastened.

Installing a child restraint system:

- ▶ Always comply with the manufacturer's installation instructions.
- ▶ Pull the seat belt smoothly from the inertia reel.
- ▶ Engage the seat belt tongue in the belt buckle.

Activating the special seat belt retractor:

- ▶ Pull the seat belt out fully and let the inertia reel retract it again.  
While the seat belt is retracting, you should hear a ratcheting sound. The special seat belt retractor is activated.
- ▶ Push down on the child restraint system to take up any slack.

Removing a child restraint system/  
deactivating the special seat belt retractor:

- ▶ Always comply with the manufacturer's installation instructions.
- ▶ Press the seat belt release button and guide the belt tongue to the belt outlet. The special seat belt retractor is deactivated.

#### Warning

Never release the seat belt buckle while the vehicle is in motion, since the special seat belt retractor will be deactivated.

### LATCH-type child restraint (ISOFIX) in the rear

#### Warning

Observe "Important safety instructions" (▷ page 58).

#### Warning

Children too big for a toddler restraint must ride in seats using regular seat belts. Position the shoulder belt across the chest and shoulder, not face or neck.

In order to attain the correct seating position for children weighing over 41 lb (18 kg), it may be necessary to use a booster seat until they reach a height where a normal lap/shoulder seat belt lies properly across their bodies without the need for a booster seat.

Install the child restraint system according to the manufacturer's instructions.

The child restraint system must be installed firmly on both brackets.

An incorrectly installed child restraint system can come loose in the event of an accident, causing the child to be severely or fatally injured.

Child restraint systems/child restraint retaining brackets that are damaged or have suffered damage due to an impact must be replaced.

ISOFIX is a standardized securing system for specially-designed child restraint systems on the rear seats. Securing rings for two ISOFIX child restraint systems are installed on the left and right of the rear seats.

Install child restraint systems without the ISOFIX securing system using the vehicle's seat belts. Follow the manufacturer's instructions for installation of child restraint systems.

**!** When installing the child restraint system, make sure that the seat belt for the center seat does not get trapped. Otherwise, the seat belt could be damaged.



► Remove covers ①.



② Securing rings

► Install the ISOFIX child restraint system. Comply with the manufacturer's instructions when installing the ISOFIX child restraint system.

## Top Tether

### **!** Warning

Observe "Important safety instructions" (▷ page 58).

### **!** Warning

Always lock the rear seat backrests in their upright position when the rear seats are occupied by passengers. Lock the rear seat backrests in their upright position before installing the Top Tether straps or when the cargo compartment is not in use. Make sure that rear seat backrests are secured properly by pushing and pulling on the seat backrests. If the seat backrest is not locked properly, the seat backrest could fold forward. The child restraint system is no longer supported properly or held in position and can no longer fulfill its function. That could cause serious or even fatal injuries.

Top Tether provides an additional connection between the child restraint system secured with ISOFIX and the rear seat. It helps reduce the risk of injury even further.

The Top Tether anchorages are located on the rear of the rear seat backrests.

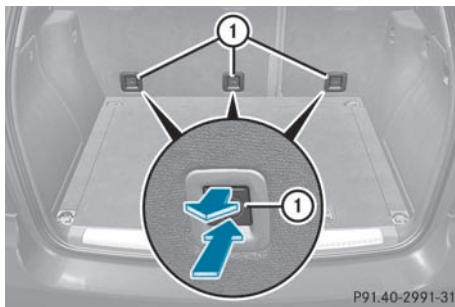

► Remove respective covering cap ① of the Top Tether anchorage.

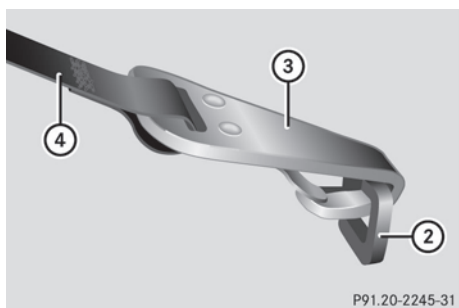
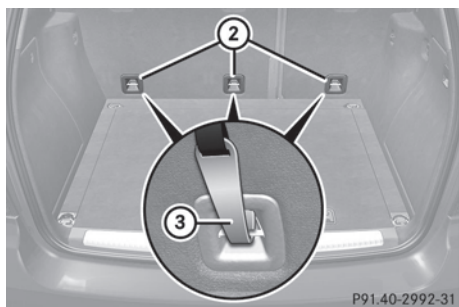

- ▶ Move the head restraint upwards.
- ▶ Install the ISOFIX child restraint system with Top Tether. Comply with the manufacturer's installation instructions when doing so.
- ▶ Route Top Tether belt (4) under the head restraint between the two head restraint bars.
- ▶ Route Top Tether belt (4) downwards between the cargo compartment cover and rear seat backrest.
- ▶ Hook Top Tether hook (3) of Top Tether belt (4) into Top Tether anchorage (2).

Ensure that:

- Top Tether hook (3) is hooked into Top Tether anchorage (2) as shown
- Top Tether belt (4) is not twisted
- Top Tether belt (4) is routed between the rear seat backrest and the cargo

compartment cover if the cargo compartment cover is installed

- Top Tether belt (4) is routed between the rear seat backrest and the cargo net if the cargo net is installed.
- ▶ Tension Top Tether belt (4). Comply with the manufacturer's installation instructions when doing so.
- ▶ Move the head restraint back down again slightly if necessary (▷ page 96). Make sure that you do not interfere with the correct routing of Top Tether belt (4).

### Child-proof locks

#### Child-proof locks for the rear doors

##### ⚠ Warning

Observe "Important safety instructions" (▷ page 58).

##### ⚠ Warning

Children could open a rear door from inside the vehicle. This could result in serious injuries or an accident. Therefore, when children ride in the rear always secure the rear doors with the child-proof locks.

You secure each door individually with the child-proof locks on the rear doors. A door secured with a child-proof lock cannot be opened from inside the vehicle. When the vehicle is unlocked, the door can be opened from the outside.

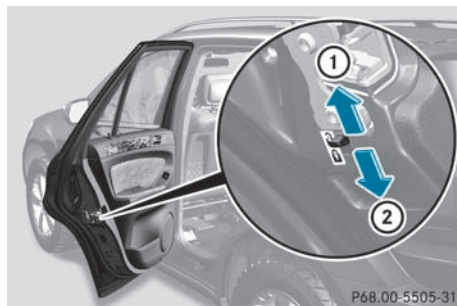

- ▶ **To activate:** press the child-proof lock lever down in the direction of arrow ②.
- ▶ Make sure that the child-proof locks are working properly.
- ▶ **To deactivate:** press the child-proof lock lever up in the direction of arrow ①.

### Override feature for the rear side windows

#### Warning

Observe "Important safety instructions" (▷ page 58).

#### Warning

When children ride on the vehicle's rear seats, activate the override switch. Otherwise, the children could be injured, e.g. by trapping themselves in the rear side window.

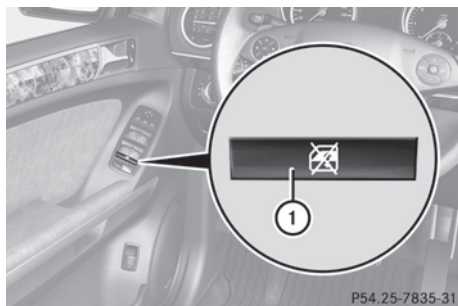

- ▶ **To activate/deactivate:** press switch ①. Switch ① engages or extends. If the switch is pushed in, it is only possible to operate the side windows in the rear using the switches on the driver's door.

### Panic alarm



- ▶ **To activate:** press and hold **PANIC** button ① for about one second. An alarm sounds and the exterior lighting flashes.
  - ▶ **To deactivate:** press **PANIC** button ① again.
- or
- ▶ Insert the SmartKey into the ignition lock.
- or
- ▶ Press the KEYLESS-GO Start-Stop button. The KEYLESS-GO key must be in the vehicle.

#### USA only:

This device complies with the part 15 of the FCC regulations. Operation is subject to the following two conditions:

1. This device may not cause interference, and
2. This device must withstand any interference received, including interference that may cause undesired operation.

Any unauthorized modification to this device could void the user's authority to operate the equipment.

#### Canada only:

This device complies with the RSS-210 regulations of Industry Canada. Operation is subject to the following two conditions:

1. This device may not cause interference, and

2. This device must withstand any interference received, including interference that may cause undesired operation of the device.  
Any unauthorized modification to this device could void the user's authority to operate the equipment.

## Driving safety systems

### Overview of driving safety systems

In this section, you will find information about the following driving safety systems:

- ABS (**A**nti-**l**ock **B**raking **S**ystem)
- BAS (**B**rake **A**ssist **S**ystem)
- ESP® (**E**lectronic **S**tability **P**rogram)
- EBD (**E**lectronic **B**rake-**p**ower **D**istribution)

### Important safety guidelines

#### **Warning**

The following factors increase the risk of accidents:

- Excessive speed, especially in turns
- Wet and slippery road surfaces
- Following another vehicle too closely

The driving safety systems described in this section cannot reduce these risks or prevent the natural laws of physics from acting on the vehicle. They cannot increase braking or steering efficiency beyond that afforded by the condition of the vehicle brakes and tires or the traction afforded.

Only a safe, attentive, and skillful driver can prevent accidents.

The capabilities of a vehicle equipped with the driving safety systems described in this section must never be exploited in a reckless or dangerous manner which could jeopardize the user's safety or the safety of others.

Always adjust your driving style to the prevailing road and weather conditions and

keep a safe distance to other road users and objects on the street.

If a driving system malfunctions, other driving safety systems may also switch off. Observe indicator and warning lamps that may come on as well as messages in the multifunction display that may appear.

#### **Warning!**

HYBRID vehicles: It is imperative that you read the HYBRID Supplemental Operating Instructions included in your vehicle literature portfolio. You may otherwise not receive all necessary safety information and warning for the operation of your vehicle.

- i** In wintry driving conditions, always use winter tires (M+S tires) and if necessary, snow chains. Only in this way will the driving safety systems described in this section work as effectively as possible.

### ABS (Anti-lock Braking System)

#### Important safety information

#### **Warning**

Observe "Important safety instructions" (▷ page 65).

#### **Warning!**

Do not pump the brake pedal. Use firm, steady brake pedal pressure instead. Pumping the brake pedal reduces the braking effect.

ABS regulates brake pressure in such a way that the wheels do not lock when you brake. This allows you to continue steering the vehicle when braking.

ABS works from a speed of about 5 mph (8 km/h) upwards, regardless of road-surface conditions. ABS works on slippery surfaces, even when you only brake gently.

The  warning lamp in the instrument cluster lights up when the ignition is switched on. It goes out when the engine is running.

## Braking

If ABS intervenes when braking, you will feel a pulsing in the brake pedal.

- ▶ **If ABS intervenes:** continue to depress the brake pedal with force until the braking situation is over.
- ▶ **To make a full brake application:** depress the brake pedal with full force.

### Warning

If the ABS malfunctions, other driving systems such as the BAS or the ESP® are also switched off. Observe indicator and warning lamps that may come on as well as messages in the multifunction display that may appear.

If the ABS malfunctions, the wheels may lock during hard braking, reducing the steering capability and extending the braking distance.

The pulsating brake pedal can be an indication of hazardous road conditions and functions as a reminder to take extra care while driving.

## Off-road ABS (vehicles with 4MATIC)

An ABS system specifically suited to off-road terrain is activated automatically if the off-road drive program (▷ page 193) is activated or the LOW RANGE off-road gear (▷ page 194) is selected.

At a speed below 18 mph (30 km/h) the front wheels lock periodically when braking. The digging-in effect achieved in the process reduces the stopping distance on off-road terrain. This limits steering capability.

### BAS (Brake Assist)

#### Warning

Observe "Important safety instructions" (▷ page 65).

BAS operates in emergency braking situations. If you depress the brake pedal

quickly, BAS automatically boosts the braking force, thus shortening the stopping distance.

- ▶ Keep the brake pedal firmly depressed until the emergency braking situation is over. ABS prevents the wheels from locking.

The brakes will function as usual once you release the brake pedal. BAS is deactivated.

### Warning

If the BAS malfunctions, the brake system still functions, but without the additional brake boost available that the BAS would normally provide in an emergency braking maneuver. Therefore, the braking distance may increase.

## ESP® (Electronic Stability Program)

### Important safety guidelines

#### Warning

Observe "Important safety instructions" (▷ page 65).

If ESP® detects that the vehicle is deviating from the direction desired by the driver, one or more wheels are braked to stabilize the vehicle. If necessary, the engine output is also modified to keep the vehicle on the desired course within physical limits. ESP® assists the driver when pulling away on wet or slippery roads. ESP® can also stabilize the vehicle during braking.

If ESP® intervenes, the  warning lamp flashes in the instrument cluster.

#### Warning

Never switch off the ESP® when you see the  warning lamp flashing in the instrument cluster. In this case proceed as follows:

- When driving off, apply as little throttle as possible.
- While driving, ease up on the accelerator pedal.
- Adapt your speed and driving style to the prevailing road conditions.

Failure to observe these guidelines could cause the vehicle to skid. The ESP® cannot prevent accidents resulting from excessive speed.

- !** Vehicles without 4MATIC: switch the ignition off when:
- the parking brake is being tested using a dynamometer
  - the vehicle is being towed with the front/rear axle raised

Application of the brakes by ESP® may otherwise destroy the brake system.

- !** Vehicles with 4MATIC: only operate the vehicle for a maximum of ten seconds on a brake test dynamometer. Switch off the ignition.

Application of the brakes by ESP® may otherwise destroy the brake system.

- !** Vehicles with 4MATIC: function or performance tests may only be carried out on a 2-axle dynamometer. If you wish to operate the vehicle on such a dynamometer, please consult an authorized Mercedes-Benz Center in advance. You could otherwise damage the drive train or the brake system.

- i** Only use wheels with the recommended tire sizes. Only then will ESP® function properly.

### ETS/4ETS (Electronic Traction System)

#### **Warning**

Observe "Important safety instructions" (> page 65).

Traction control is part of ESP®.

Traction control brakes the drive wheels individually if they spin. This enables you to pull away and accelerate on slippery surfaces, for example if the road surface is slippery on one side. On vehicles with 4MATIC, more drive torque is also transferred to the wheel or wheels with traction.

Traction control remains active if you deactivate ESP®.

- Switch on the off-road drive program if appropriate for the driving conditions (> page 193).

### Off-road 4ETS (vehicles with 4MATIC)

A 4ETS mode specifically suited to off-road terrain is activated automatically once the off-road drive program (> page 193) is activated.

### Deactivating/activating ESP®

#### **Warning**

The ESP® should not be switched off during normal driving other than in the circumstances described below. Disabling the system will reduce vehicle stability in driving maneuvers.

Do not switch off the ESP® when a spare wheel is mounted.

ESP® is activated automatically when the engine is running.

It may be best to deactivate ESP® in the following situations:

- when using snow chains
- in deep snow
- on sand or gravel

#### **Warning!**

Activate ESP® as soon as the situations described above no longer apply. ESP® will otherwise not be able to stabilize the vehicle if the vehicle starts to skid or a wheel starts to spin.

If you deactivate ESP®:

- ESP® no longer improves driving stability.
- the engine's torque is no longer limited and the drive wheels can spin. The spinning of the wheels results in a cutting action, which provides better grip.

- traction control is still activated.
- ESP® still provides support when you brake.

If ESP® is deactivated and one or more wheels start to spin, the  warning lamp in the instrument cluster flashes. In such situations, ESP® will not stabilize the vehicle.

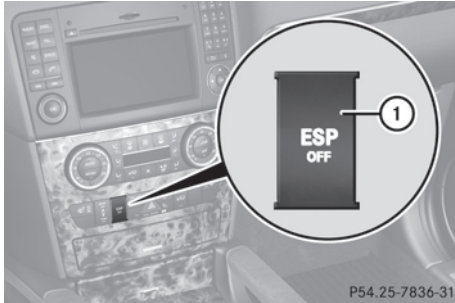

► **To deactivate:** press button ①.

The  warning lamp in the instrument cluster lights up.

 **Warning**

When the  ESP® warning lamp is illuminated continuously, the ESP® is switched off or is not operational due to a malfunction. Vehicle stability in standard driving maneuvers is reduced.

Adapt your speed and driving style to the prevailing road conditions and to the non-operating status of the ESP®.

-  Avoid spinning a drive wheel for an extended period with ESP switched off. This could cause serious damage to the drive train.

► **To activate:** press button ①.

The  warning lamp in the instrument cluster goes out.

### Off-road ESP®

An ESP® system specifically suited to off-road terrain is activated automatically once the off-road drive program (▷ page 193) is activated. It intervenes with a delay if there is

oversteering or understeering, thus improving traction.

### ESP® trailer stabilization

If your trailer begins to lurch, you can only stabilize the vehicle/trailer combination by depressing the brake firmly.

In this situation, ESP® assists you and can detect if the trailer begins to lurch. ESP® slows the vehicle down by braking and limiting the engine output until the vehicle/trailer combination has stabilized.

Trailer stabilization is active from a speed above 40 mph (65 km/h).

 **Warning!**

The system will not be able to assist when the trailer jackknifes

- if the ESP® has switched off due to a malfunction
- on wet or icy roads
- on roads with slippery surface
- in sand or gravel

Trailers with a high center of gravity may tip over before the system recognizes swaying of the trailer.

Trailer stabilization does not work if ESP® is deactivated or disabled because of a malfunction.

### EBD

 **Warning**

Observe "Important safety instructions" (▷ page 65).

EBD monitors and controls the brake pressure on the rear wheels to improve driving stability while braking.

 **Warning!**



If the EBD malfunctions, the brake system will still function with full brake boost. However, the rear wheels could lock up during

emergency braking situations, for example. You could lose control of the vehicle and cause an accident.

Adapt your driving style to the changed driving characteristics.

### Distance warning function (vehicles with DISTRONIC)

This function warns you from a speed of approximately 20 mph (30 km/h), if:

- for a period of several seconds, the distance to the vehicle in front is too short for the speed at which you are traveling. The  distance warning lamp in the instrument cluster will light up.
- you are approaching the vehicle in front rapidly. An intermittent warning tone will then sound and the  distance warning lamp in the instrument cluster will light up.

You must apply the brakes yourself in order to maintain the appropriate distance to the vehicle in front and prevent a collision.

#### **Warning!**

If the distance warning lamp  in the instrument cluster comes on while driving and/or an intermittent warning sounds, immediate attention on the part of the driver is required. As required by the traffic situation, apply the brakes and navigate around a possible obstacle. However, do not drive by relying on the distance warning function, as this will result in an emergency braking application. This will not always enable you to avoid a collision, especially when traveling on varying road surface conditions and with varying driver reaction.

Complex driving situations are not always fully recognized by the distance warning function. This could result in wrong or missing distance warnings.

- ▶ **To activate/deactivate:** activate or deactivate the distance warning function in the on-board computer (▷ page 219). After activation, the  symbol is displayed in the lower multifunction display.

## Anti-theft systems

### Immobilizer

The immobilizer prevents your vehicle from being started without the correct SmartKey. When leaving the vehicle, always take the SmartKey with you and lock the vehicle. The engine can be started by anyone with a valid SmartKey that is left inside the vehicle.

- ▶ **To activate with the SmartKey:** remove the SmartKey from the ignition lock.
- ▶ **To activate with KEYLESS-GO:** switch the ignition off and open the driver's door.
- ▶ **To deactivate:** switch on the ignition.

-  The immobilizer is always deactivated when you start the engine.

In the event that the engine cannot be started when the starter battery is fully charged, the immobilizer may be faulty. Contact an authorized Mercedes-Benz Center or call 1-800-FOR-MERCEdes (in USA) or 1-800-387-0100 (in Canada).

### ATA (Anti-Theft Alarm system)

A visual and audible alarm is triggered if the alarm system is armed and you open:

- a door
- the vehicle with the mechanical key
- the tailgate
- the hood

The alarm is not switched off, even if you close the open door that has triggered it, for example.

- i** If the alarm stays on for more than 30 seconds, the emergency call system mbrace (USA only) or Tele Aid (Canada only) initiates a call to the Customer Assistance Center automatically. The emergency call system initiates the call provided that:
- you have subscribed to the mbrace/Tele Aid service
  - the mbrace/Tele Aid service has been activated properly
  - the mobile phone, power supply and GPS necessary are available

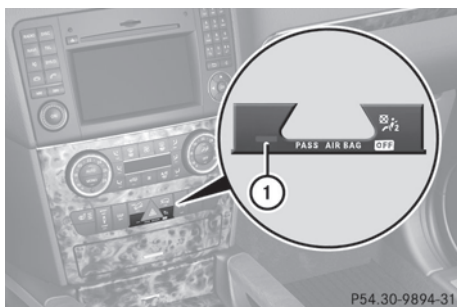

- **To arm:** lock the vehicle with the SmartKey or KEYLESS-GO. The turn signal lamps flash three times to indicate that the vehicle is locked. Indicator lamp ① flashes to indicate that the alarm system is armed.
- i** If the turn signal lamps do not flash three times, a door or the tailgate may not be properly closed. It may be necessary to close the affected door or the tailgate.
- **To deactivate:** unlock the vehicle using the key or KEYLESS-GO. The turn signal lamps flash once to indicate that the anti-theft alarm system is switched off.

- i** Unless you open a door or the trunk lid within 40 seconds after unlocking the vehicle:

- the vehicle will be locked again.
- the anti-theft alarm system will be re-armed.

- **To stop the alarm using the SmartKey:** insert the key into the ignition lock. The alarm is switched off.

or

- Press the  or  button on the key. The alarm is switched off.

- **To stop the alarm using KEYLESS-GO:** grasp the outside door handle. The key must be outside the vehicle. The alarm is switched off.

or

- Press the Start/Stop button on the dashboard. The key must be inside the vehicle. The alarm is switched off.

Vehicle equipment .....	72
SmartKey .....	72
Doors .....	78
Cargo compartment .....	80
Side windows .....	84
Sliding sunroof .....	88

## Vehicle equipment

- i** This manual describes all the standard and optional equipment of your vehicle which was available at the time of purchase. Country-specific differences are possible. Bear in mind that your vehicle may not feature all functions described here. This also refers to safety-related systems and functions.

## SmartKey

### Important safety guidelines

#### **Warning!**

When leaving the vehicle, always remove the SmartKey from the starter switch. Always take the SmartKey with you and lock the vehicle. Do not leave children unattended in the vehicle, even if they are secured in a child restraint system, or with access to an unlocked vehicle. A child's unsupervised access to a vehicle could result in an accident and/or serious personal injury. The children could

- injure themselves on parts of the vehicle
- be seriously or fatally injured through excessive exposure to extreme heat or cold
- injure themselves or cause an accident with vehicle equipment that can be operated even if the SmartKey is removed from the starter switch or removed from the vehicle, such as seat adjustment, steering wheel adjustment, or the memory function

If children open a door, they could injure other persons or get out of the vehicle and injure themselves or be injured by following traffic.

Do not expose the child restraint system to direct sunlight. The child restraint system's metal parts, for example, could become very hot, and the child could be burned by these parts.

#### **Warning!**

Do not carry heavy or hard objects in the passenger compartment or cargo compartment unless they are firmly secured in place.

Unsecured or improperly positioned cargo increases a child's risk of injury in the event of

- strong braking maneuvers
- sudden changes of direction
- an accident

## General information

If you cannot open or lock the vehicle with the SmartKey, either the battery in the SmartKey is empty, the SmartKey is faulty, or the vehicle battery is discharged.

- ▶ Check the battery in the SmartKey and replace it if necessary (▷ page 76).
- ▶ Unlock the driver's door using the mechanical key (▷ page 75).
- ▶ Lock the vehicle using the mechanical key (▷ page 75).
- ▶ Have the vehicle battery and battery contacts checked by an authorized Mercedes-Benz Center.

If the SmartKey is faulty, contact Roadside Assistance or an authorized Mercedes-Benz Center.

## SmartKey functions

### General notes

- i** USA only:

This device complies with Part 15 of the FCC regulations. Operation is subject to the following conditions:

1. This device must not cause any harmful interference, and
2. This device must be able to accommodate interference that is

received, including interference which could cause unwanted functions.

Unapproved modifications to this device may lead to withdrawal of permission to operate it.

**i** Canada only:

This device complies with Industry Canada's RSS-210 regulations. Operation is subject to the following conditions:

1. This device must not cause any harmful interference, and
2. This device must be able to accommodate interference that is received, including interference which could cause unwanted functions.



Unapproved modifications to this device may lead to withdrawal of permission to operate it.

### Locking and unlocking centrally

The SmartKey centrally locks/unlocks:

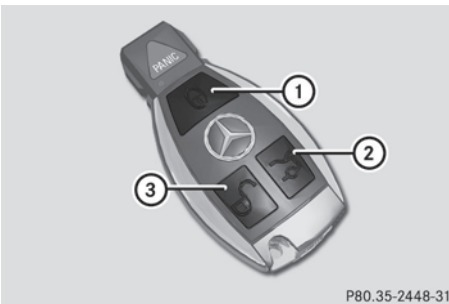
- the doors
- the tailgate
- the fuel filler flap



- ①  To lock the vehicle
- ②  To open/close the tailgate
- ③  To unlock the vehicle

When unlocking, the turn signals flash once. When locking, they flash three times.

When it is dark, the surround lighting also comes on if it is activated in the on-board computer.

- **To unlock centrally:** press the  button.

If you do not open a door or the tailgate within approximately 40 seconds of unlocking the vehicle:

- the vehicle is locked again.
- the theft deterrent locking system is armed again.

- **To lock centrally:** press the  button.

### KEYLESS-GO

#### General notes

**i** USA only:

This device complies with Part 15 of the FCC regulations. Operation is subject to the following conditions:

1. This device must not cause any harmful interference, and
2. This device must be able to accommodate interference that is received, including interference which could cause unwanted functions.

Unapproved modifications to this device may lead to withdrawal of permission to operate it.

**i** Canada only:

This device complies with Industry Canada's RSS-210 regulations. Operation is subject to the following conditions:

1. This device must not cause any harmful interference, and
2. This device must be able to accommodate interference that is received, including interference which could cause unwanted functions.

Unapproved modifications to this device may lead to withdrawal of permission to operate it.

## Important information about using KEYLESS-GO

- You can use the KEYLESS-GO key as a conventional SmartKey.
- You can combine KEYLESS-GO functions with those of a conventional SmartKey, e.g. you can open the vehicle with KEYLESS-GO and close it with the  button.
- Always carry your KEYLESS-GO key on your person.
- Never store the KEYLESS-GO key together with:
  - electronic devices, such as a mobile phone or other SmartKey
  - metal objects, such as coins or metal foil

Doing so may impair the function of KEYLESS-GO.

- To open or close the vehicle, the KEYLESS-GO key should not be more than 3 ft (1 m) from the door or tailgate.
- If the vehicle is parked for more than 72 hours, the KEYLESS-GO function is deactivated. Pull an outer door handle and switch on the ignition to reactivate the KEYLESS-GO function.
- If the KEYLESS-GO key is removed from the vehicle, the system may not be able to recognize the SmartKey anymore. The vehicle can then no longer be locked or started with KEYLESS-GO.
- If the KEYLESS-GO key has been removed from the vehicle, e.g. when another vehicle occupant with a KEYLESS-GO key leaves the vehicle:
  - when the Start/Stop button is pressed, or when trying to lock the vehicle using the locking button on the outside door handle, the **Key Not Detected** message appears in the multifunction display.
  - when the engine is running, the red **Key Not Detected** message appears in the multifunction display as you pull away. Look for the KEYLESS-GO key and place it somewhere else in the vehicle. Place the KEYLESS-GO key on the front-

passenger seat, for example, or in your shirt pocket.

- If you have switched on the engine with the Start/Stop button, you can switch it off again by:
  - pressing the Start/Stop button
  - inserting the KEYLESS-GO key into the ignition lock while the vehicle is at a standstill and the automatic transmission is in park position **P**.
- You may inadvertently unlock the vehicle if the KEYLESS-GO key is less than 3 ft (1 m) from the vehicle and:
  - an exterior door handle is hit by a jet of water, or
  - you clean an exterior door handle
- Please note that any vehicle occupant can start the engine when there is a KEYLESS-GO key in the vehicle.

**Scenario 1:** There is a KEYLESS-GO key in the vehicle and a second one outside the vehicle. If you leave the KEYLESS-GO key in the vehicle when you leave and lock the vehicle, no message appears in the multifunction display.

**Scenario 2:** There is a KEYLESS-GO key in the vehicle, but none outside the vehicle. If you get out of the vehicle and attempt to lock it, the **Key Detected In Vehicle** message appears in the multifunction display. The vehicle is not then locked.

When starting the engine and whilst driving, KEYLESS-GO also checks whether a valid SmartKey is in the vehicle by periodically establishing radio contact.

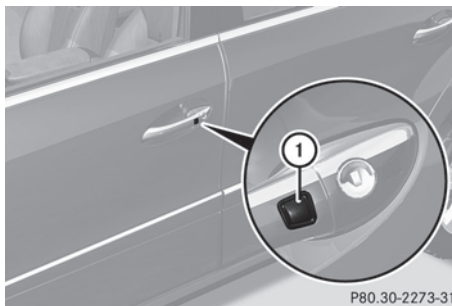



P80.30-2273-31

- ▶ **To unlock the vehicle:** touch the inner surface of the door handle.
- ▶ **To lock the vehicle:** press locking button ①.



If you pull on the handle of the tailgate, only the cargo compartment of the vehicle is unlocked.

### Changing the settings of the locking system

You can change the setting of the locking system in such a way that only the driver's door and the fuel filler flap are unlocked. This is useful if you frequently travel on your own.

- ▶ **To change the setting:** press and hold down the  and  buttons simultaneously for approximately six seconds until the battery check lamp (▷ page 76) flashes twice.



The SmartKey now functions as follows:

- ▶ **To unlock the driver's door:** press the  button once.
- ▶ **To unlock centrally:** press the  button twice.
- ▶ **To lock centrally:** press the  button.

The KEYLESS-GO function is changed as follows:

- ▶ **To unlock the driver's door:** touch the inner surface of the door handle on the driver's door.
- ▶ **To unlock centrally:** touch the inner surface of the door handle on the front-passenger door or the rear door.
- ▶ **To lock centrally:** press locking button ① on one of the door handles.

### Restoring the factory settings

- ▶ Press the  and  buttons simultaneously for approximately six seconds until the battery check lamp flashes twice.



### Mechanical key

#### General notes

If the vehicle can no longer be unlocked with the SmartKey, use the mechanical key.

If you use the mechanical key to unlock and open the driver's door, the anti-theft alarm system will be triggered (▷ page 69).

There are several ways to turn off the alarm:

- ▶ Press the  or  button on the SmartKey.
- or
- ▶ Insert the SmartKey into the ignition lock.
- or
- ▶ Press the Start/Stop button in the ignition lock. The SmartKey must be in the vehicle.
- or
- ▶ Lock or unlock the vehicle using KEYLESS-GO. The SmartKey must be outside the vehicle.

#### Removing the mechanical key

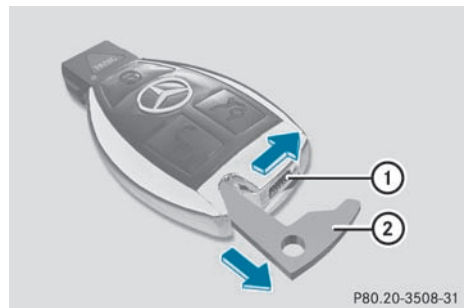

- ▶ Push release catch ① in the direction of the arrow and at the same time, remove mechanical key ② from the SmartKey.

### SmartKey battery

#### Important safety guidelines

It is advisable to have batteries replaced at a qualified specialist workshop, e.g. at an authorized Mercedes-Benz Center.

**Warning**

Batteries contain toxic and caustic substances. For this reason, keep batteries out of the reach of children.

If a battery has been swallowed, seek medical help immediately.

**Warning**



The SmartKey batteries contain perchlorate material, which may require special handling and regard for the environment. Observe government disposal guidelines. California residents, see [www.dtsc.ca.gov/HazardousWaste/Perchlorate/index.cfm](http://www.dtsc.ca.gov/HazardousWaste/Perchlorate/index.cfm).

**Checking the battery**

- ▶ Press the  or  button.

The SmartKey battery is working properly if battery charge indicator lamp ① lights up briefly.

If battery charge indicator lamp ① does not light up briefly during the test, the SmartKey battery is discharged.

- ▶ Replace the SmartKey battery (▷ page 76).
- i** You can obtain a SmartKey battery at any authorized Mercedes-Benz Center.
- i** If the SmartKey battery is checked within signal range of the vehicle, pressing the  or  button results in the vehicle being locked or unlocked respectively.

**Changing the battery**

You require a CR 2025 3 V cell battery.



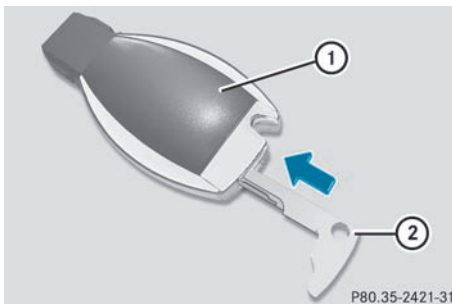

- ▶ Take the mechanical key out of the SmartKey (▷ page 75).

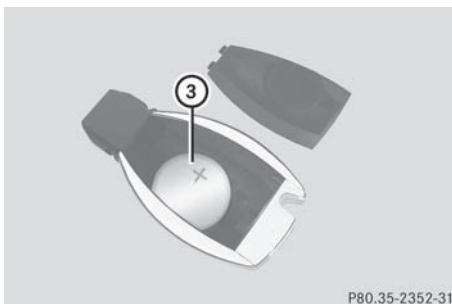

- ▶ Press mechanical key ② into the opening in the SmartKey in the direction of the arrow until battery tray cover ① opens. Do not hold the cover closed while doing so.



- ▶ Remove the cover of the battery tray.
- ▶ Repeatedly tap the SmartKey against your palm until battery ③ falls out.
- ▶ Insert the new battery with the positive pole facing upwards. Use a lint-free cloth to do so.
- ▶ Insert the front tabs of the battery tray's cover first and then press to close it.
- ▶ Check the function of all SmartKey buttons on the vehicle.

Problems with the SmartKey	
Problem	Possible causes/consequences and ► Solutions
You cannot lock or unlock the vehicle using the SmartKey.	<p>The SmartKey battery is discharged or nearly discharged.</p> <ul style="list-style-type: none"> <li>► Point the tip of the SmartKey at the driver's door handle from a distance of approximately 1.5 ft (50 cm) and try to unlock or lock the vehicle again.</li> </ul> <p>If this does not work:</p> <ul style="list-style-type: none"> <li>► Check the SmartKey battery and replace it if necessary (▷ page 76).</li> <li>► Lock (▷ page 80) or unlock (▷ page 80) the vehicle using the mechanical key.</li> </ul>
	<p>The SmartKey is faulty.</p> <ul style="list-style-type: none"> <li>► Lock (▷ page 80) or unlock (▷ page 80) the vehicle using the mechanical key.</li> <li>► Have the SmartKey checked at a qualified specialist workshop.</li> </ul>
You can no longer lock or unlock the vehicle using KEYLESS-GO.	<p>KEYLESS-GO is in standby mode because the vehicle has not been unlocked for an extended period.</p> <ul style="list-style-type: none"> <li>► Pull the door handle twice and then insert the SmartKey into the ignition lock.</li> </ul>
	<p>There is a malfunction with KEYLESS-GO.</p> <ul style="list-style-type: none"> <li>► Lock/unlock the vehicle using the remote control function of the SmartKey. Point the tip of the SmartKey at the driver's door handle from close range and press the  /  button.</li> <li>► Have the SmartKey checked at a qualified specialist workshop.</li> </ul>
	<p>There is interference from a powerful source of radio waves.</p> <ul style="list-style-type: none"> <li>► Lock/unlock the vehicle using the remote control function of the SmartKey. Point the tip of the SmartKey at the driver's door handle from close range and press the  /  button.</li> </ul>
You have lost the SmartKey.	<ul style="list-style-type: none"> <li>► Have the SmartKey canceled at an authorized Mercedes-Benz Center.</li> <li>► Report the loss immediately to the vehicle insurers.</li> <li>► If necessary, have the locks changed as well.</li> </ul>
You have lost the mechanical key.	<ul style="list-style-type: none"> <li>► Report the loss immediately to the vehicle insurers.</li> <li>► If necessary, have the locks changed as well.</li> </ul>

Problem	Possible causes/consequences and ► Solutions
The engine cannot be started using the SmartKey.	<p>The on-board voltage is too low.</p> <ul style="list-style-type: none"> <li>► Switch off non-essential consumers, e.g. seat heating or interior lighting, and try to start the engine again.</li> </ul> <p>If this does not work:</p> <ul style="list-style-type: none"> <li>► Check the starter battery and charge it if necessary (► page 312).</li> </ul> <p>or</p> <ul style="list-style-type: none"> <li>► Jump-start the vehicle (► page 315).</li> </ul> <p>or</p> <ul style="list-style-type: none"> <li>► Consult a qualified specialist workshop.</li> </ul>
The engine cannot be started using KEYLESS-GO. The SmartKey is in the vehicle.	<p>A door is open. Therefore, the SmartKey cannot be detected as easily.</p> <ul style="list-style-type: none"> <li>► Close the door and try to start the vehicle again.</li> </ul> <p>There is interference from a powerful source of radio waves.</p> <ul style="list-style-type: none"> <li>► Start your vehicle with the SmartKey in the ignition lock.</li> </ul>

## Doors

### Important safety guidelines

#### **Warning!**

When leaving the vehicle, always remove the SmartKey from the starter switch. Always take the SmartKey with you and lock the vehicle. Do not leave children unattended in the vehicle, even if they are secured in a child restraint system, or with access to an unlocked vehicle. A child's unsupervised access to a vehicle could result in an accident and/or serious personal injury. The children could

- injure themselves on parts of the vehicle
- be seriously or fatally injured through excessive exposure to extreme heat or cold
- injure themselves or cause an accident with vehicle equipment that can be operated even if the SmartKey is removed from the starter switch or removed from the vehicle, such as seat adjustment, steering wheel adjustment, or the memory function

If children open a door, they could injure other persons or get out of the vehicle and injure themselves or be injured by following traffic.

Do not expose the child restraint system to direct sunlight. The child restraint system's metal parts, for example, could become very hot, and the child could be burned by these parts.

#### **Warning!**

Do not carry heavy or hard objects in the passenger compartment or cargo compartment unless they are firmly secured in place.

Unsecured or improperly positioned cargo increases a child's risk of injury in the event of

- strong braking maneuvers
- sudden changes of direction
- an accident

### Unlocking and opening doors from the inside

You can open a door from inside the vehicle even if it has been locked, unless the child-proof locks have been activated (▷ page 63). Open the door only when the traffic conditions permit.

If the vehicle has been opened with the SmartKey or KEYLESS-GO key, opening from inside triggers the anti-theft alarm system. Switch off the alarm (▷ page 69).

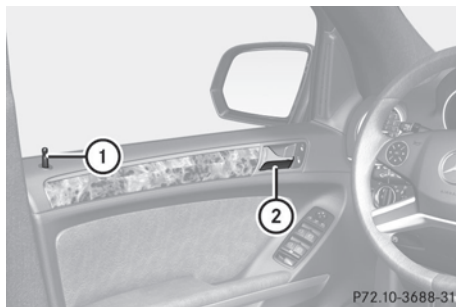

- ▶ Pull door handle ①.  
If the door is locked, locking knob ② pops up. The door is unlocked and can be opened.

### Centrally locking and unlocking the vehicle from the inside

You can centrally lock or unlock the vehicle from the inside. This feature may be useful if, for example, you wish to unlock the front-passenger door from the inside or lock the vehicle before you pull away.

The central locking/unlocking button does not lock or unlock the fuel filler flap.

The buttons are located on both front doors.

- ❗ You cannot unlock the vehicle centrally from the inside if the vehicle has been locked with the SmartKey or KEYLESS-GO.
- ❗ It is only possible to lock the vehicle centrally if the front-passenger door is closed.

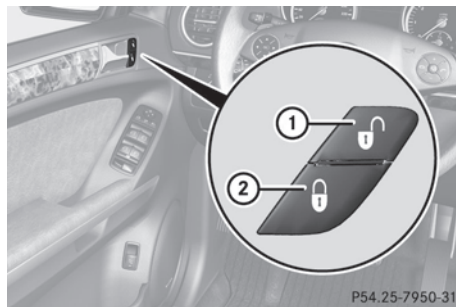

- ▶ **To lock:** press button ②.  
The vehicle locks itself when all doors and the tailgate are closed.
- ▶ **To unlock:** press button ①.

You can open a front door from inside the vehicle even if it has been locked. Open the door only when the traffic conditions permit. If the vehicle has been locked with the locking button for the central locking function:

- and the SmartKey has been reset to the factory settings, the complete vehicle is unlocked when a front door is opened from the inside
- and the SmartKey has been set to an individual setting, only the front door that is opened from the inside is unlocked

If the vehicle has been locked centrally with the SmartKey or with KEYLESS-GO, it is not unlocked if you use the unlocking button for the central locking system.

### Automatic locking

The vehicle locks automatically when the ignition is switched on and the wheels of the vehicle are moving at a speed above 9 mph (15 km/h). Therefore, there is a risk of being locked out when the vehicle is being pushed, towed or tested on a dynamometer.

You can switch the automatic locking function on and off using the on-board computer (▷ page 217).

### Unlocking the driver's door (mechanical key)

If the vehicle can no longer be unlocked centrally with the SmartKey or KEYLESS-GO:

- ▶ Take the mechanical key out of the SmartKey (▷ page 75).
- ▶ Insert the mechanical key into the lock of the driver's door as far as it will go.

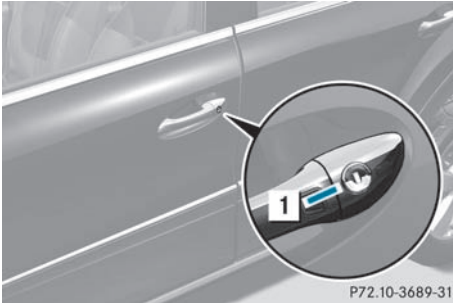

- ▶ Firmly turn the mechanical key counter-clockwise as far as it will go to position **1** and hold it in this position.
- ▶ Pull the door handle quickly. The locking knob pops up. The door is unlocked.
- ▶ Turn the mechanical key back and remove it.
- ▶ Pull the door handle again.

### Locking the vehicle

If the vehicle can no longer be locked centrally with the SmartKey or KEYLESS-GO:

- ▶ Close the front-passenger door, the rear door on the front-passenger side and the tailgate.
- ▶ Open the driver's door and the rear door on the driver's side.
- ▶ Press the locking button on the driver's door (▷ page 79). The locking knobs in the front-passenger door and in the rear doors drop down.

- ▶ Press down the locking knobs in the front-passenger and rear doors manually, if necessary.
- ▶ Close the driver's door from the outside.
- ▶ Press down the locking knob of the driver's door by reaching in through the open rear door.
- i** Make sure that you have the SmartKey on your person and that it has not been left in the vehicle.
- ▶ Close the rear door on the driver's side.
- ▶ Make sure that the doors and the tailgate are locked.
- i** If you lock the vehicle as described above, the fuel filler flap is not locked. The anti-theft alarm system is not primed.

## Cargo compartment

### Important safety guidelines

Do not leave the SmartKey in the cargo compartment. You could otherwise lock yourself out.

#### Warning

When leaving the vehicle, always remove the SmartKey from the ignition lock. Always take the SmartKey with you and lock the vehicle. Do not leave children unsupervised in the vehicle, even if they are secured in a child restraint system, and do not give them access to an unlocked vehicle. A child's unsupervised access to a vehicle could result in an accident and/or serious personal injury. They could:

- injure themselves on vehicle parts
- be seriously or fatally injured by extreme heat or cold
- injure themselves or have an accident with vehicle equipment that may still be in operation even after the SmartKey has been removed from the ignition, such as the seat adjustment, steering wheel adjustment or memory function.

If children open a door, they could cause severe or even fatal injury to other persons; if they get out of the vehicle, they could injure themselves when doing so or be seriously or even fatally injured by any passing traffic.

Do not expose the child restraint system to direct sunlight. The child restraint system's metal parts, for example, could become very hot, and a child could be burned on these parts.

### **Warning!**

Do not carry heavy or hard objects in the passenger compartment or cargo compartment unless they are firmly secured in place.

Unsecured or improperly positioned cargo increases a child's risk of injury in the event of

- strong braking maneuvers
- sudden changes of direction
- an accident

### **Warning!**

Make sure the tailgate is closed when the engine is running and while driving. Among other dangers, deadly carbon monoxide (CO) gases may enter vehicle interior resulting in unconsciousness and death.

 The tailgate swings upwards and to the rear when opened. Therefore, make sure that there is sufficient clearance above and behind the tailgate.

For the tailgate to be opened fully, there must be a minimum clearance from floor to ceiling of 7.20 ft (2.20 m).

The tailgate can be:

- opened and closed manually from outside
- opened and closed automatically from outside
- opened and closed automatically from inside

## Opening and closing from the outside

### Opening

You can only open the tailgate after unlocking it first.

- ▶ Press the  button on the SmartKey.



P72.20-2918-31

- ▶ Pull handle ①.
- ▶ Raise the tailgate.

### Closing

#### **Warning!**

To prevent possible personal injury, always keep hands and fingers away from the cargo compartment opening when closing the tailgate. Be especially careful when small children are around.



P72.20-2919-31

- ▶ Pull the tailgate down using recess ①.
- ▶ Push the tailgate closed from outside the vehicle.
- ▶ Lock the vehicle if necessary with the  button on the SmartKey or with KEYLESS-GO (▷ page 73).

### Automatic opening and closing from the outside

#### Important safety guidelines

##### Warning!

Make sure the tailgate is closed when the engine is running and while driving. Among other dangers, deadly carbon monoxide (CO) gases may enter vehicle interior resulting in unconsciousness and death.

**!** The tailgate swings upwards and to the rear when opened. Therefore, make sure that there is sufficient clearance above and behind the tailgate.

For the tailgate to be opened fully, there must be a minimum clearance from floor to ceiling of 7.20 ft (2.20 m).

#### Opening

You can open the tailgate automatically with the SmartKey or the handle in the tailgate.

▶ Press and hold the  button on the SmartKey until the tailgate opens.

or

▶ When the tailgate is unlocked, pull the handle and let it go again immediately.

#### Closing

##### Warning!

Monitor the closing procedure carefully to make sure no one is in danger of being injured. To prevent possible personal injury, always keep hands and fingers away from the cargo compartment opening when closing the tailgate. Be especially careful when small children are around. To stop the closing procedure, do one of the following:

- Press or pull the remote tailgate opening/closing switch on the driver's door.
- Press the tailgate closing switch.

- Press the KEYLESS-GO locking/closing switch.
- Pull outside handle on the tailgate.
- When no SmartKey is inserted in the starter switch (vehicles with KEYLESS-GO: Make sure the vehicle's on-board electronics have status **0**): Press button  on the SmartKey.

You can close the tailgate automatically using the SmartKey, the closing button<sup>6</sup> or the locking button<sup>7</sup>.



Closing button and locking button (example: vehicle with the EASY-PACK tailgate and KEYLESS-GO)

▶ **To close:** press closing button ① on the tailgate.

or

▶ Press and hold the  button on the SmartKey until the tailgate closes.

▶ **To close and lock simultaneously:** Press locking button ② on the tailgate.

**i** The tailgate can only be opened and closed with the SmartKey if there is no SmartKey in the ignition lock.

If the tailgate touches an object while closing, the closing procedure is interrupted and the tailgate reopens.

**i** Only with KEYLESS-GO: if you leave a KEYLESS-GO key in the cargo compartment, the tailgate will not lock.

<sup>6</sup> For vehicles with the EASY-PACK tailgate only.

<sup>7</sup> For vehicles with the EASY-PACK tailgate and KEYLESS-GO only.

The tailgate is not closed unless a KEYLESS-GO key is detected.

### Automatic opening and closing from the inside

#### **Warning!**

Maintain sight of the area around the rear of the vehicle while operating the tailgate with the door-mounted remote tailgate switch. Monitor the opening procedure carefully to make sure no one is in danger of being injured.

To interrupt the opening procedure, press or pull the door-mounted remote tailgate switch.

When the SmartKey is not inserted in the starter switch (vehicles with KEYLESS-GO: Make sure the vehicle's on-board electronics have status **0**): Press button  on the SmartKey.

#### **Warning!**

Maintain sight of the area around the rear of the vehicle while operating the tailgate with the door-mounted remote tailgate switch. Monitor the closing procedure carefully to make sure no one is in danger of being injured.

To interrupt the closing procedure, press or pull the door-mounted remote tailgate switch.

#### **Warning!**

To prevent possible personal injury, always keep hands and fingers away from the cargo compartment opening when closing the tailgate. Be especially careful when small children are around.

#### **Warning!**

Make sure the tailgate is closed when the engine is running and while driving. Among other dangers, deadly carbon monoxide (CO) gases may enter vehicle interior resulting in unconsciousness and death.

You can open/close the tailgate from the driver's seat when the vehicle is stationary.



- ▶ **To open:** pull remote operating switch ① for the tailgate until the tailgate opens.
- ▶ **To close:** turn the SmartKey to position **1** or **2** in the ignition lock.
- ▶ Press remote operating switch for tailgate ① until the tailgate is closed.

If the tailgate touches an object, the closing procedure is interrupted and the tailgate reopens.

- ▶ **To interrupt the closing procedure:** pull or push the remote operating switch for tailgate ①.

### Limiting the opening angle of the tailgate

#### Important safety guidelines

You can limit the opening angle of the tailgate in the top half of its opening range. This could be useful, for example, if there is insufficient space above the tailgate.

- ❗ Make sure there is sufficient clearance to open the tailgate fully when setting the opening angle. The tailgate could otherwise be damaged. Ideally, set the opening angle outside.

## Activating the tailgate

- ▶ **To open the tailgate:** pull the handle on the tailgate.
- ▶ **To stop the opening procedure at the desired position:** press the close button (> page 82) on the tailgate or pull the handle on the outside of the tailgate again.
- ▶ **To store the position:** press and hold the closing button on the tailgate until you hear a short tone.  
The opening angle limiter is activated. The tailgate will now stop in the stored position when opening.

## Deactivating the tailgate

- ▶ Press and hold the closing button (> page 82) in the tailgate until you hear two short tones.

## Tailgate emergency release

If the tailgate can no longer be opened from outside the vehicle, use the emergency release on the inside of the tailgate.

To open the tailgate completely, a minimum clearance of 7.20 ft (220 cm) above the ground is necessary.

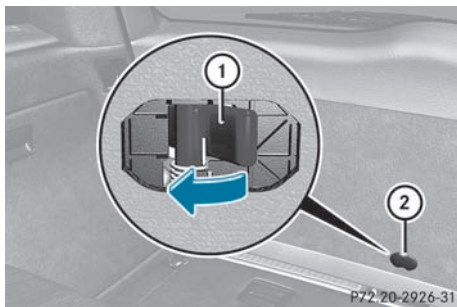

- ❗ The tailgate swings upwards and to the rear when opened. Therefore, make sure that there is sufficient clearance above and behind the tailgate.

- ▶ Pull cover (2) off the tailgate trim.
- ▶ Push release catch (1) to the left as far as the stop and open the tailgate.

## Side windows

### Important safety guidelines

#### Warning

When leaving the vehicle, always remove the SmartKey from the ignition lock. Always take the SmartKey with you and lock the vehicle. Do not leave children unsupervised in the vehicle, even if they are secured in a child restraint system, and do not give them access to an unlocked vehicle. A child's unsupervised access to a vehicle could result in an accident and/or serious personal injury. They could:

- injure themselves on vehicle parts
- be seriously or fatally injured by extreme heat or cold
- injure themselves or have an accident with vehicle equipment that may still be in operation even after the SmartKey has been removed from the ignition, such as the seat adjustment, steering wheel adjustment or memory function.

If children open a door, they could cause severe or even fatal injury to other persons; if they get out of the vehicle, they could injure themselves when doing so or be seriously or even fatally injured by any passing traffic.

Do not expose the child restraint system to direct sunlight. The child restraint system's metal parts, for example, could become very hot, and a child could be burned on these parts.

#### Warning!

Do not carry heavy or hard objects in the passenger or cargo compartment unless they are firmly secured in place.

Unsecured or improperly positioned cargo increases a child's risk of injury in the event of

- strong braking maneuvers
- sudden changes of direction
- an accident

### **Warning!**

When opening or closing the door windows, make sure there is no danger of anyone being harmed by the opening/closing procedure.

The door windows are equipped with the automatic operation and anti-entrapment features. If during automatic operation a door window encounters an obstruction that blocks its path, the anti-entrapment feature will stop the door window and open it slightly.

The door windows operate differently when the switch is pulled and held. See the "Closing when a door window is blocked" section in this chapter for details.

The closing of the door windows can be immediately halted by releasing the switch or, if the switch was pulled past the resistance point and released, by either pressing or pulling the respective switch.

If a door window encounters an obstruction that blocks its path in a circumstance where you are closing the door windows by pressing and holding button  on the SmartKey or by pressing and holding the lock button (vehicles with KEYLESS-GO) on an outside door handle, the anti-entrapment feature will not operate.

Activate the override switch when children are riding in the back seats of the vehicle. The children may otherwise injure themselves, e.g. by becoming trapped in the door window opening.

### **Warning!**

Do not keep any part of your body up against the window pane when opening a window. The downward motion of the pane may pull that part of your body down between the window

pane and the door frame and trap it there. If there is a risk of entrapment, release the switch and pull it to close the window.

## Opening and closing the side windows

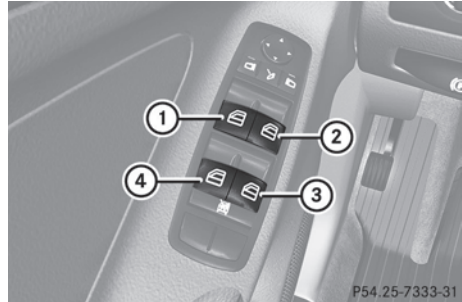

- ① Front left
- ② Front right
- ③ Rear right
- ④ Rear left

The switches for all side windows are located on the driver's door. There is also a switch on each door for the corresponding side window.

**i** It is not possible to operate the door windows from the rear compartment when the override feature is activated for the door windows.

- ▶ Turn the SmartKey to position **2** in the ignition lock.
- ▶ **To open:** press the corresponding switch.
- ▶ **To close:** pull the corresponding switch.

**i** If you press the switch beyond the point of resistance, an automatic opening/closing process is started in the corresponding direction. You can stop automatic operation by pressing again.

**i** You can continue to operate the side windows after you switch off the engine. This function remains active for five minutes or until one of the front doors is opened.



P54.25-7333-31

### Convenience opening

You can ventilate the vehicle before you start driving. To do this, you can use the SmartKey to simultaneously:

- open the side windows
- open the sliding sunroof
- switch on the seat ventilation of the driver's seat (Canada only)

**i** The convenience opening feature can only be operated using the SmartKey. The SmartKey must be close to the driver's door handle.

- ▶ Point the tip of the SmartKey at the driver's door handle.
- ▶ Unlock the vehicle by pressing the  button.
- ▶ Press and hold the  button until the side windows and the sliding sunroof are in the desired position.
- ▶ **To interrupt the convenience opening:** release the  button.

### Convenience closing

#### General information



When you lock the vehicle, you can simultaneously:

- close the side windows
- close the sliding sunroof

#### Warning

When closing the door windows and the sliding sunroof, make sure that there is no danger of anyone being harmed by the closing procedure.

If potential danger exists, proceed as follows:

- Release the  button to stop the closing procedure. To open, press and hold the  button. To continue the closing procedure after making sure that there is no danger of anyone being harmed by the



closing procedure, press and hold the  button.

Vehicles with KEYLESS-GO:

- Release the lock button on the outside door handle to stop the closing procedure.
- Immediately pull on the same outside door handle and hold firmly. The door windows and the sliding sunroof will open for as long as the door handle is held but the door is not opened.

### Using the SmartKey

**i** The SmartKey must be close to the driver's door handle.

- ▶ Point the tip of the SmartKey at the driver's door handle.
- ▶ Lock the vehicle by pressing the  button.
- ▶ Press and hold the  button until the side windows and the sliding sunroof are fully closed.
- ▶ Make sure that all the side windows and the sliding sunroof are closed.
- ▶ **To interrupt the convenience closing:** release the  button.

### Using KEYLESS-GO

The KEYLESS-GO key must be outside the vehicle but must not be further than 3 ft (1 m) from a door.

- ▶ Close all the doors.

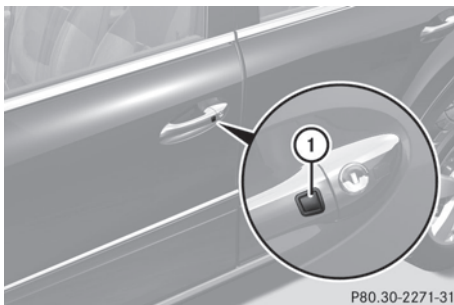

P80.30-2271-31

- ▶ Keep locking button ① on the door handle pressed until the side windows and the sliding sunroof are fully closed.
- ▶ Make sure that all the side windows and the sliding sunroof are closed.
- ▶ **To interrupt convenience closing:** release locking button ① on the door handle.

### Resetting the side windows

You must reset each side window if:

- the battery has been disconnected or has become discharged.
- the side window can no longer be fully opened or closed.
- ▶ Close all the doors.
- ▶ Turn the SmartKey to position **2** in the ignition lock.
- ▶ Pull the corresponding switch on the door control panel until the side window is completely closed. (▷ page 85)
- ▶ Hold the switch for an additional second.

If the side window opens again slightly:

- ▶ Immediately pull the corresponding switch on the door control panel until the side window is completely closed (▷ page 85).
- ▶ Hold the switch for an additional second.
- ▶ If the corresponding side window remains closed after the button has been released, the side window has been reset correctly. If this is not the case, repeat the steps above again.

### Problems with the side windows

**Problem: a side window cannot be closed because objects are trapped between the side window and the door frame.**

- ▶ Remove the objects.
- ▶ Close the side window.

**Problem: a side window cannot be closed because objects in the guide rail are preventing the window from being raised.**

- ▶ Remove the objects.
- ▶ Close the side window.

**Problem: a side window cannot be closed, and you cannot see the cause.**

#### Warning

Closing the side windows with increased force or without the anti-entrapment feature could lead to serious or even fatal injury. Make sure that nobody can become trapped when closing the side windows.

If a side window is obstructed during closing and reopens again slightly:

- ▶ Immediately after the window blocks, pull the corresponding switch again until the side window has closed.  
The side window is closed with increased force.

If a side window is obstructed again during closing and reopens again slightly:

- ▶ Immediately after the window blocks, pull the corresponding switch again until the side window has closed.  
The side window is closed without the anti-entrapment feature.

#### Warning!

Pulling and holding the switch to close the door window immediately after it had been blocked two times will cause the door window to close without the anti-entrapment feature for as long as you hold the switch.

## Sliding sunroof

### Important safety guidelines

#### Warning!

When leaving the vehicle, always remove the SmartKey from the starter switch. Always take the SmartKey with you and lock the vehicle. Do not leave children unattended in the vehicle, even if they are secured in a child restraint system, or with access to an unlocked vehicle. A child's unsupervised access to a vehicle could result in an accident and/or serious personal injury. The children could

- injure themselves on parts of the vehicle
- be seriously or fatally injured through excessive exposure to extreme heat or cold
- injure themselves or cause an accident with vehicle equipment that can be operated even if the SmartKey is removed from the starter switch or removed from the vehicle, such as seat adjustment, steering wheel adjustment, or the memory function

If children open a door, they could injure other persons or get out of the vehicle and injure themselves or be injured by following traffic.

Do not expose the child restraint system to direct sunlight. The child restraint system's metal parts, for example, could become very hot, and the child could be burned by these parts.

#### Warning!

Do not carry heavy or hard objects in the passenger or cargo compartment unless they are firmly secured in place.

Unsecured or improperly positioned cargo increases a child's risk of injury in the event of

- strong braking maneuvers
- sudden changes of direction
- an accident

#### Warning!

When opening or closing the tilt/sliding sunroof, make sure there is no danger of anyone being harmed by the opening/closing procedure.

The tilt/sliding sunroof is equipped with the automatic operation and anti-entrapment features. If the movement of the tilt/sliding sunroof is blocked during the closing procedure, the tilt/sliding sunroof will stop and open slightly.

The tilt/sliding sunroof operates differently when the sunroof switch is pressed and held. See the "Closing when the tilt/sliding sunroof is blocked" section for details.

The opening/closing procedure of the tilt/sliding sunroof can be immediately halted by releasing the sunroof switch or, if the sunroof switch was moved past the resistance point and released, by moving the sunroof switch in any direction.

#### Warning!

The tilt/sliding sunroof is made out of glass. In the event of an accident, the glass may shatter. This may result in an opening in the roof.

In a vehicle rollover, occupants not wearing their seat belts or not wearing them properly may be thrown out of the opening. Such an opening also presents a potential for injury for occupants wearing their seat belts properly as entire body parts or portions of them may protrude from the passenger compartment.

 Only open the sliding sunroof if it is free of snow and ice. Otherwise, malfunctions may occur.

Do not allow anything to protrude from the sliding sunroof. Otherwise, the seals could be damaged.

 If the sliding sunroof cannot be opened or closed due to a malfunction, contact a qualified specialist workshop, e.g. an authorized Mercedes-Benz Center.

**!** Do not forget that the weather can change abruptly. Make certain that the sliding sunroof is closed when you leave the vehicle. The vehicle electronics can be damaged if water enters the vehicle interior.

**i** Resonance noises can occur in addition to the usual airflow noises when the sliding sunroof is open. They are caused by minor pressure fluctuations in the vehicle interior. Change the position of the sliding sunroof or open a side window slightly to reduce or eliminate these noises.

## Operating the sliding sunroof

### Opening and closing

**i** You can still operate the tilt/sliding sunroof even if you switch off the engine or remove the SmartKey. This function remains active for five minutes or until one of the front doors is opened.

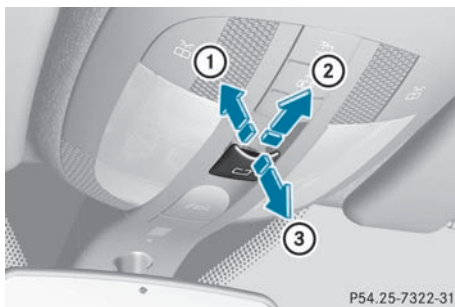

Overhead control panel

- ① To raise
- ② To open
- ③ To close

- ▶ Switch on the ignition.
- ▶ Push or pull the  switch in the corresponding direction.

**i** If you press the  switch beyond the point of resistance, an automatic opening/closing process is started in the

corresponding direction. You can stop automatic operation by pressing again.

Automatic opening/raising is only available if the tilt/sliding sunroof is in the closed position.

You can open/close the cover for the sunblind manually when the tilt/sliding sunroof is raised/closed.

### Resetting

Reset the tilt/sliding sunroof if it does not open smoothly, or if the battery has been disconnected or has become discharged.

**!** Contact a qualified specialist workshop if the tilt/sliding sunroof cannot be closed fully or reset.

- ▶ Remove the SmartKey from the ignition lock or turn to position **0** (KEYLESS-GO).
- ▶ Remove the fuse for the tilt/sliding sunroof from the main fuse box. To find out where the fuse is located, refer to the fuse allocation chart in the vehicle tool kit (▷ page 298).
- ▶ Reinsert the fuse.
- ▶ Switch on the ignition.
- ▶ Raise the tilt/sliding sunroof fully at the rear (▷ page 89).
- ▶ Keep the  switch pressed for another second.
- ▶ Make sure that the tilt/sliding sunroof can be opened or closed fully again using the opening/closing process (▷ page 89).
- ▶ If the tilt/sliding sunroof can be raised fully at the rear it is set correctly. If this is not the case, you must repeat the previously described steps.

### Problems with the sliding sunroof

**Problem: the sunroof cannot be closed and you cannot see the cause.**

 **Warning!**

You could be severely or even fatally injured when closing the sliding sunroof with increased closing force or if the anti-entrapment feature is deactivated. Make sure that nobody can become trapped when closing the sliding sunroof.

If the sliding sunroof is obstructed during closing:

- ▶ Immediately after the sliding sunroof blocks, pull the  switch in the overhead control panel down to the point of resistance and hold it until the sliding sunroof is closed.  
The sliding sunroof is closed with increased force.

If the sliding sunroof is obstructed during closing again:

- ▶ Immediately after the sliding sunroof blocks, pull the  switch in the overhead control panel down to the point of resistance and hold it until the sliding sunroof is closed.  
The sliding sunroof is closed without the anti-entrapment feature.

 **Warning!**

Pressing and holding the sliding sunroof switch to close the sliding sunroof immediately after it had been blocked two times will cause the sliding sunroof to close without the anti-entrapment feature for as long as you hold the switch.

Vehicle equipment .....	92
Correct driver's seat position .....	92
Seats .....	93
Steering wheel .....	99
Mirrors .....	101
Memory functions .....	103

## Vehicle equipment

**i** This manual describes all the standard and optional equipment of your vehicle which was available at the time of purchase. Country-specific differences are possible. Bear in mind that your vehicle may not feature all functions described here. This also refers to safety-related systems and functions.

## Correct driver's seat position

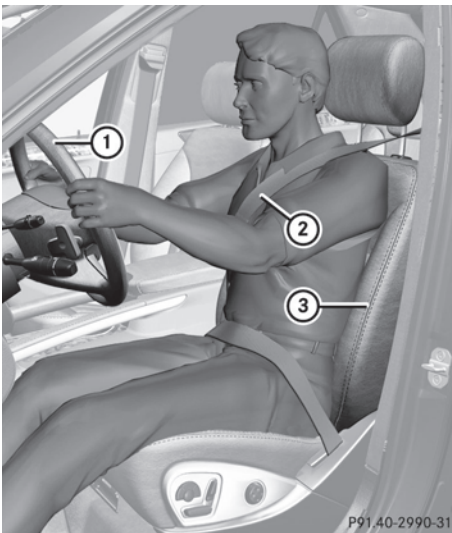

Observe the important safety notes on (▷ page 93).

► Check whether you have adjusted seat ③ properly.

Electrical seat adjustment (▷ page 94)

When adjusting the seat, make sure:

- you are as far away from the driver's air bag as possible.
- you are sitting in a normal upright position.
- you can fasten the seat belt properly.
- you have moved the backrest to an almost vertical position.

- you have set the seat cushion angle so that your thighs are gently supported.
- you can depress the pedals properly.

► Check whether the head restraint is adjusted properly (▷ page 95).

When doing so, make sure that you have adjusted the head restraint so that the back of your head is supported at eye level by the center of the head restraint.

Observe the important safety notes on (▷ page 99).

► Check whether steering wheel ① is adjusted properly.

Adjusting the steering wheel manually (▷ page 99)

Adjusting the steering wheel electrically (▷ page 100)

When adjusting the steering wheel, make sure:

- you can hold the steering wheel with your arms slightly bent.
- you can move your legs freely.
- you can see all the displays in the instrument cluster clearly.

Observe the important safety notes on (▷ page 53).

► Check whether you have fastened seat belt ② properly (▷ page 55).

The seat belt should:

- fit snugly across your body
- be routed across the middle of your shoulder
- be routed in your pelvic area across the hip joints

► Before starting off, adjust the rear-view mirror and the exterior mirrors

(▷ page 101) in such a way that you have a good view of road and traffic conditions.

► **Vehicles with memory function:** save the seat, steering wheel and exterior mirror settings (▷ page 103).

## Seats

### Important safety guidelines

#### Warning

In order to avoid possible loss of vehicle control, all seat, head restraint, steering wheel and rear view mirror adjustments, as well as fastening of seat belts, must be done before setting the vehicle in motion.

#### Warning

Do not adjust the driver's seat while driving. Adjusting the seat while driving could cause the driver to lose control of the vehicle.

Never travel in a moving vehicle with the seat backrest in an excessively reclined position as this can be dangerous. You could slide under the seat belt in a collision. If you slide under it, the seat belt would apply force at the abdomen or neck. This could cause serious or fatal injuries. The seat backrest and seat belts provide the best restraint when the wearer is in a position that is as upright as possible and seat belts are properly positioned on the body.

#### Warning

Your seat belt must be adjusted so that you can correctly fasten your seat belt.

Observe the following points:

- adjust the seat backrest until your arms are slightly angled when holding the steering wheel.
- adjust the seat to a comfortable seating position that still allows you to reach the accelerator/brake pedal safely. The position should be as far back as possible with the driver still able to operate the controls properly.
- adjust the head restraint so that it is as close to the head as possible and the center

of the head restraint supports the back of the head at eye level.

- never place hands under the seat or near any moving parts while a seat is being adjusted.

Failure to do so could result in an accident and/or serious personal injury.

#### Warning

The electrically adjustable seats can be operated at any time. Therefore, do not leave children unattended in the vehicle, or with access to an unlocked vehicle. A child's unsupervised access to a vehicle could result in an accident and/or serious personal injury.

#### Warning!

According to accident statistics, children are safer when properly restrained in the rear seating positions than in the front seating position. Thus, we strongly recommend that children be placed in the rear seats whenever possible. Regardless of seating position, children 12 years old and under must be seated and properly secured in an appropriately sized infant restraint, toddler restraint, or booster seat recommended for the size and weight of the child. For additional information, see "Children in the vehicle".

A child's risk of serious or fatal injuries is significantly increased if the child restraints are not properly secured in the vehicle and/or the child is not properly secured in the child restraint.

#### Warning

For your protection, drive only with properly positioned head restraints.

Adjust the head restraint so that it is as close to the head as possible and the center of the head restraint supports the back of the head at eye level. This will reduce the potential for injury to the head and neck in the event of an accident or similar situation.

Do not drive the vehicle without the seat head restraints. Head restraints are intended to help reduce injuries during an accident.



To avoid damage to the seats and the seat heating, observe the following information:

- do not spill any liquids on the seats. If liquid is spilled on the seats, dry them as soon as possible.
- if the seat covers are damp or wet, do not switch on the seat heating. The seat heating should also not be used to dry the seats.
- clean the seat covers as recommended; see the "Interior care" section.
- do not transport heavy loads on the seats. Do not place sharp objects on the seat cushions, e.g. knives, nails or tools. The seats should only be occupied by passengers, if possible.
- when the seat heating is in operation, do not cover the seats with insulating materials, e.g. covers, bags, seat covers, child seats or booster seats.

**!** When you move the seats, make sure that there are no objects in the footwell or behind the seats. Otherwise, you could damage the seats and the objects.

**!** When the rear bench seat is folded forwards, the front seats cannot be moved to their rearmost position. You could otherwise damage the seats and the rear bench seat.

**!** Make sure that the sun visor is folded up before adjusting the backrest and head restraint height. The head restraint and sun visor could otherwise collide when the head restraint is fully extended.

**i** The rear-compartment head restraints can be removed (> page 96). Please contact an authorized Mercedes-Benz Center for more information.

<sup>8</sup> Only for vehicles with the memory function.

**i** Related topics:

- Cargo compartment enlargement (folding the rear bench seat forwards) (> page 258)

### Adjusting the seats

**i** Vehicles without the memory function: the seats can be adjusted within five minutes of opening a front door.

The time span starts over if, within these five minutes, you:

- open or close a front door
- insert the key into or remove the key from the ignition lock
- switch the ignition on or off.

If the key is in position **2** in the ignition, you can adjust the seats at any time.

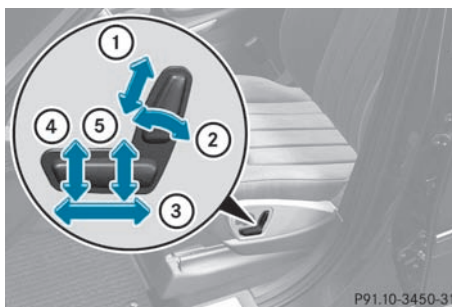

- ① Head restraint height<sup>8</sup>
- ② Backrest angle
- ③ Seat fore-and-aft adjustment
- ④ Seat cushion angle
- ⑤ Seat height

**i** Vehicles with the memory function: if PRE-SAFE<sup>®</sup> is triggered, the front-passenger seat will be moved to a better position if it was previously in an unfavorable position.

**i** You can store the seat settings using the memory function (> page 103).

P91.10-3450-31

## Adjusting the head restraints

### Adjusting the head restraints manually

#### Adjusting the head restraint height<sup>9</sup>

**!** The head restraints may only be removed in a qualified specialist workshop. Mercedes-Benz recommends that you go to an authorized Mercedes-Benz Center.

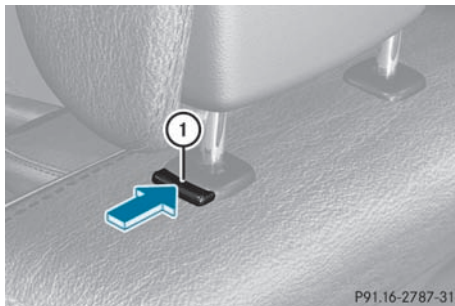

- ▶ If the head restraint is fully lowered, it is necessary to press release catch ①.
- ▶ **To raise:** pull the head restraint up to the desired position.
- ▶ **To lower:** press release catch ① in the direction of the arrow and push the head restraint down to the desired position.

#### Adjusting the angle of the head restraints

##### **⚠ Warning!**

Vehicles with Rear Seat Entertainment System: When adjusting the head restraint, make sure your fingers do not become caught between the head restraint cushion and the monitor. Failing to do so may lead to injury.



- ▶ Push or pull the lower edge of the head restraint in the direction of the arrow.

#### Adjusting the head restraints electrically<sup>10</sup>

- ▶ **To adjust the head restraint height:** slide the switch for head restraint adjustment (▷ page 94) up or down in the direction of the arrow.

#### Adjusting the luxury head restraints<sup>11</sup>

##### **⚠ Warning!**

When folding back the head restraint side bolsters, do not put your hands between the side bolster and the cushion holder. There is a danger of becoming trapped.

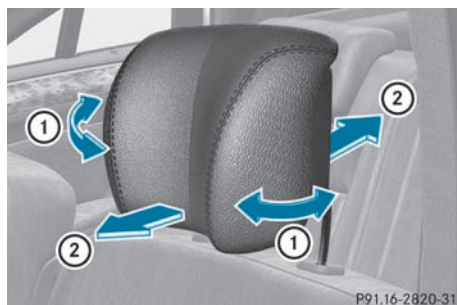

- ▶ **To adjust the side bolsters of the head restraint:** push or pull right and/or left-

<sup>9</sup> For vehicles without memory function only.

<sup>10</sup> Only for vehicles with memory function.

<sup>11</sup> Only for Canada.

hand side bolster ① into the desired position.

- ▶ **To adjust the angle of the head restraint:** push or pull the head restraint in the direction of arrow ②.

### Rear seat head restraints

#### **Warning!**

For your protection, drive only with properly positioned head restraints.

Adjust the head restraint in such a way that it is as close to the head as possible and the center of the head restraint supports the back of the head at eye level. This will reduce the potential for injury to the head and neck in the event of an accident or similar situation.

With a rear seat occupied, make sure to move the respective head restraint up from the lowest non-use position and have the occupant adjust the head restraint properly.

Do not drive the vehicle without the seat head restraints installed when the rear seats are occupied. Head restraints are intended to help reduce injuries during an accident.

### Adjusting the rear seat head restraint height

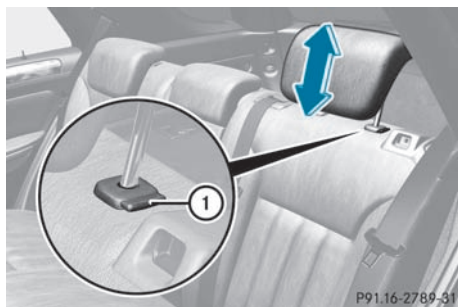

If the head restraint is fully lowered, it is necessary to press release catch ①.

- ▶ **To raise:** pull the head restraint up to the desired position.

- ▶ **To lower:** press release catch ① and push the head restraint down until it is in the desired position.

### Adjusting the rear seat head restraint angle

Adjust the head restraints so that they are as close as possible to your head.

You can only adjust the two outer head restraints.

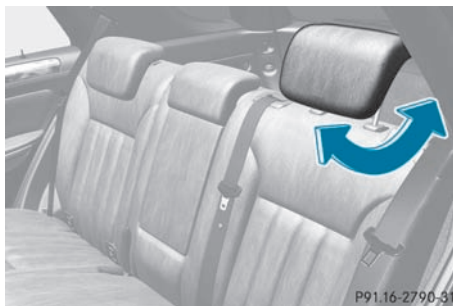

- ▶ Using both hands, reach backwards and grasp the sides of the head restraint.
- ▶ Pull the lower edge of the head restraint forwards or backwards until it is in the desired position.

### Removing and installing the rear head restraints

#### **Warning!**

Occupants should only travel sitting on seats which have the head restraints installed. In the event of an accident, this reduces the risk of injury for passengers seated in the rear compartment.

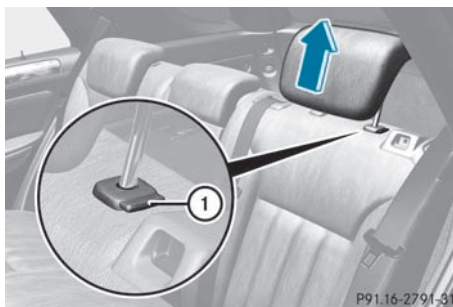

- ▶ **To remove:** pull the head restraint up to the stop.
- ▶ Press release catch ① and pull the head restraint out of the guides.
- ▶ **To re-install:** insert the head restraint so that the notches on the bar are on the left when viewed in the direction of travel.
- ▶ Push the head restraint down until you hear it engage in position.

### Adjusting the multicontour seat

You can adjust the contour of the front seats individually so as to provide optimum support for your back and sides.

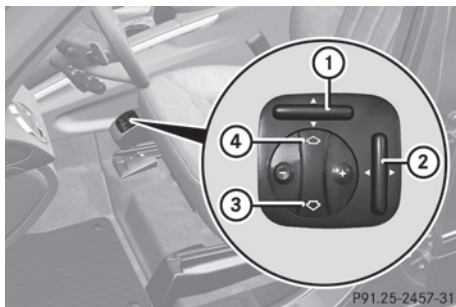

- ▶ Make sure that the key is in position **2** in the ignition lock.
- ▶ Use switch ① to move the thigh cushion into the desired position.
- ▶ Press the **+** or **-** button to adjust the contour of the backrest to suit your back.
- ▶ Press button ④ to move the point of greatest backrest curvature downwards to the lumbar region and press button ③ to move it upwards to the upper back region.
- ▶ Use button ② to adjust the side bolsters for optimal lateral support.

### Adjusting the four-way lumbar support

The lumbar support for the driver's seat can be individually adjusted to provide optimum support for your back.

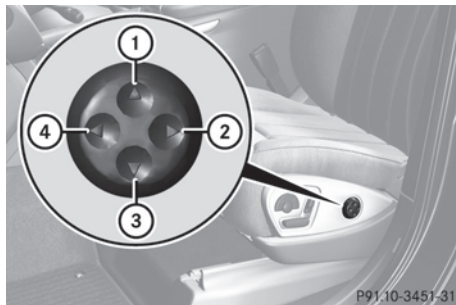

- ① To raise the backrest contour
- ② To soften the backrest contour
- ③ To lower the backrest contour
- ④ To harden the backrest contour

### Switching the seat heating on/off

#### Switching on/off

#### **Warning!**

Repeatedly setting the seat heating to level **3** may result in excessive seat temperatures. The health of passengers that have limited temperature sensitivity or a limited ability to react to excessively high temperatures may be affected or they may even suffer burn-like injuries. Therefore, do not use seat heating level **3** repeatedly.

The three red indicator lamps in the button indicate the heating level you have selected.

- i** If the battery voltage is too low, the seat heating may switch off. One or several indicator lamps in the seat heating button flash.



Driver's and front-passenger seat

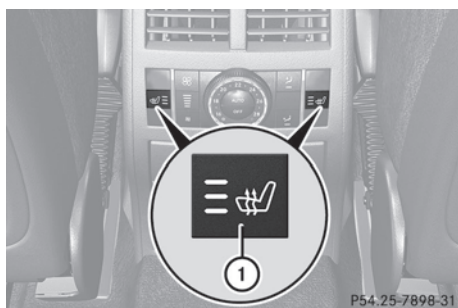

Rear compartment seats

The system automatically switches down from level **3** to level **2** after approximately five minutes.

The system automatically switches down from level **2** to level **1** after approximately ten minutes.

The system automatically switches off approximately 20 minutes after it is set to level **1**.

- ▶ Make sure that the key is in position **2** in the ignition lock.
- ▶ **To switch on:** press button ① repeatedly until the desired heating level is set.
- ▶ **To switch off:** press button ① repeatedly until all the indicator lamps go out.

## Problems with the seat heating

If one or all of the indicator lamps in the seat heating button are flashing, the seat heating has switched off automatically. The vehicle's electrical system voltage is too low because too many electrical consumers are switched on.

- ▶ Switch off electrical consumers which you do not need, such as the rear window defroster or interior lighting. Once the battery is sufficiently charged, the seat heating will switch back on automatically.

## Switching the seat ventilation on/off

### Switching on/off

The three blue indicator lamps in the buttons indicate the ventilation level you have selected.

- ❗ If the battery voltage is too low, the seat ventilation may switch off.

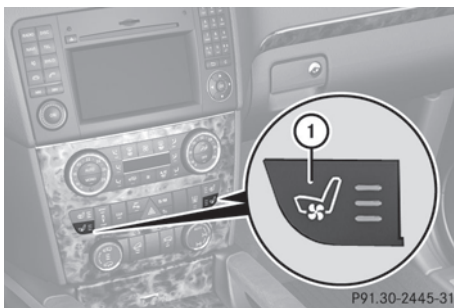

- ▶ Make sure that the key is in position **2** in the ignition lock.
- ▶ **To switch on:** press button ① repeatedly until the desired ventilation level is set.

- ❗ You can open the side windows and the tilt/sliding sunroof with the key (▷ page 86). The seat ventilation of the driver's seat automatically switches to the highest level.

- ▶ **To switch off:** press button ① repeatedly until all the indicator lamps go out.

### Problems with the seat ventilation

If one or all of the indicator lamps in the seat ventilation button are flashing, the seat ventilation has switched off automatically. The vehicle's electrical system voltage is too low because too many electrical consumers are switched on.

- ▶ Switch off electrical consumers which you do not need, such as the rear window defroster or interior lighting. Once the battery is sufficiently charged, the seat ventilation will switch back on automatically.

## Steering wheel

### Important safety guidelines

#### **Warning**

Do not adjust the steering wheel while driving. Adjusting the steering wheel while driving, or driving without the steering wheel adjustment feature locked could cause the driver to lose control of the vehicle.

The electrical steering wheel adjustment feature can be operated at any time. Therefore, do not leave children unattended in the vehicle, or with access to an unlocked vehicle. A child's unsupervised access to a vehicle could result in an accident and/or serious personal injury.

### Adjusting the steering wheel manually

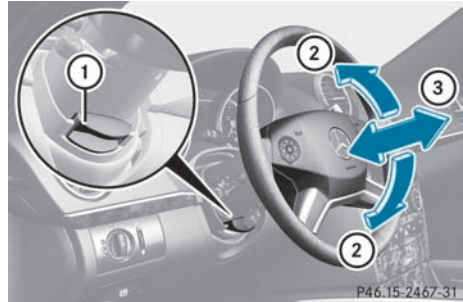

- ① Release handle
  - ② To adjust the steering wheel height
  - ③ To adjust the steering wheel position (fore-and-aft adjustment)
- ▶ Pull release handle ① out completely. The steering column is unlocked.
  - ▶ Adjust the steering wheel to the desired position.
  - ▶ Push release handle ① in completely until it engages fully. The steering column is locked.
  - ▶ Check if the steering column is locked. When doing so, try to push the steering wheel up or down or try to move it in the fore-and-aft direction.

### Adjusting the steering wheel electrically

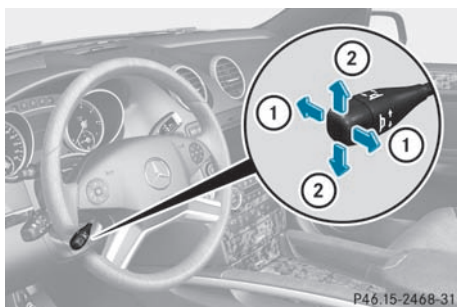

- ① To adjust the steering wheel position (fore-and-aft adjustment)
- ② To adjust the steering wheel height

#### **i** Related topics:

- EASY-ENTRY/EXIT feature (▷ page 100)
- storing settings (▷ page 103)

### Steering wheel heating

#### Switching on/off

The steering-wheel heating heats the leather areas of the steering wheel.

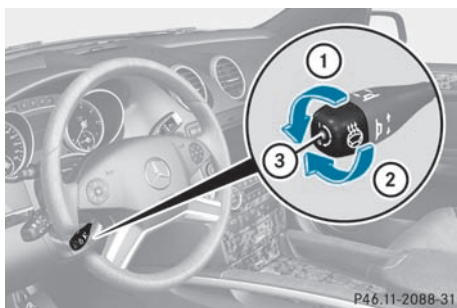

- ▶ Make sure that the key is in position **2** in the ignition lock.
- ▶ **To switch on/off:** turn the lever in the direction of arrow **①** or **②**. Indicator lamp **③** comes on or goes out.

### Problems with the steering wheel heating

If the steering wheel heating indicator lamp on the lower left lever of the steering column is flashing, the steering wheel heating has switched off automatically. The vehicle's electrical system voltage is too low because too many electrical consumers are switched on.

- ▶ Switch off electrical consumers which you do not need, such as the rear window defroster or interior lighting. Once the battery is sufficiently charged, the steering wheel heating will switch back on automatically.

### EASY-ENTRY/EXIT

#### **⚠ Warning**

You must make sure no one can become trapped or injured by the moving steering wheel when the easy-entry/exit feature is activated.

To stop steering wheel movement do one of the following:

- Move steering wheel adjustment stalk.
- Press one of the memory position buttons.
- Press memory button **M**.

Do not leave children unattended in the vehicle, or with access to an unlocked vehicle. Children could open the driver's door and unintentionally activate the easy-entry/exit feature, which could result in an accident and/or serious personal injury.

The EASY-ENTRY/EXIT feature makes getting in and out of your vehicle easier.

The steering wheel swings upwards when you:

- remove the key from the ignition lock.
- open the driver's door and KEYLESS-GO is in position **1**
- open the driver's door and the key is in position **0** or **1** in the ignition lock.

**i** The steering wheel only moves upwards if it has not already reached the upper end stop.

The steering wheel is moved to the last selected position when:

- the driver's door is closed, and
- you insert the key into the ignition lock. or
- in vehicles with KEYLESS-GO, you press the Start/Stop button once.

When you close the driver's door with the ignition switched on, the steering wheel is also automatically moved to the previously set position.

The last position of the steering wheel is stored when you switch off the ignition or when you store the setting with the memory function (> page 103).

You can activate and deactivate the EASY-ENTRY/EXIT feature in the on-board computer (> page 218).

**Warning**

Let the system complete the adjustment procedure before setting the vehicle in motion. All steering wheel adjustment must be completed before setting the vehicle in motion. Driving off with the steering wheel still adjusting could cause the driver to lose control of the vehicle.

**i** If the crash-responsive EASY-EXIT feature is triggered in an accident, the steering column will move upwards when the driver's door is opened. This occurs irrespective of the position of the key in the ignition lock. This makes it easier to exit the vehicle and rescue the occupants.

The crash-responsive EASY-EXIT feature is only operational after an accident if the EASY-EXIT/ENTRY feature is activated in the on-board computer.

**Mirrors**

**Rear-view mirror**

**Rear-view mirror (manual anti-glare)**

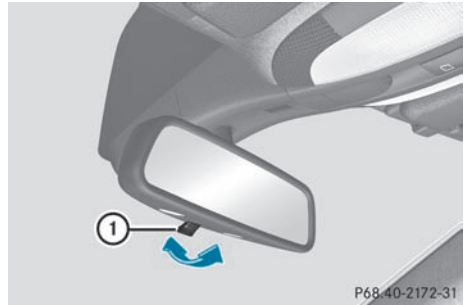

► **Anti-glare mode:** flick anti-glare switch ① forwards or back.

**Exterior mirrors**

**Adjusting the exterior mirrors**

**Warning**

Exercise care when using the passenger-side exterior rear view mirror. The mirror surface is convex (outwardly curved surface for a wider field of view). Objects in mirror are closer than they appear. Check your interior rear view mirror and glance over your shoulder before changing lanes.

The exterior mirrors are automatically heated if the rear window heating is switched on and the outside temperature is low.

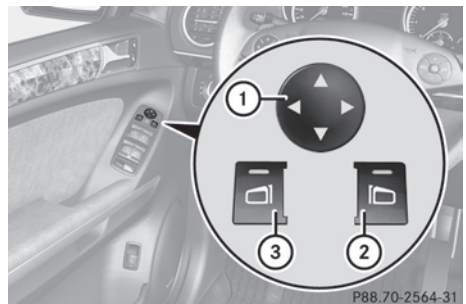

- ▶ Make sure that the SmartKey is in position **1** or **2** in the ignition lock.
- ▶ Press button **(2)** for the right-hand exterior mirror or button **(3)** for the left-hand exterior mirror.  
The indicator lamp in the corresponding button lights up in red.  
The indicator lamp goes out again after some time. You can adjust the selected mirror using adjustment button **(1)** as long as the indicator lamp is lit.
- ▶ Press adjustment button **(1)** up, down, to the right or to the left until the exterior mirror is set to a position that provides you with a good overview of traffic conditions.

### Folding the exterior mirrors in or out electrically

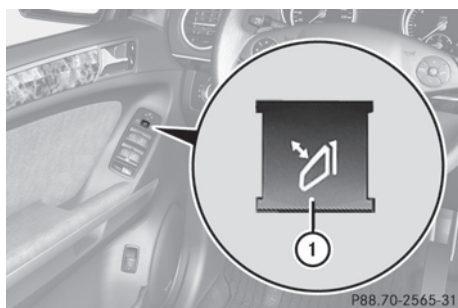

- ▶ Make sure that the SmartKey is in position **1** or **2** in the ignition lock.
- ▶ Briefly press button **(1)**.  
Both exterior mirrors fold in or out.
- i** Make sure that the exterior mirrors are always folded out fully while the vehicle is in motion, as they may otherwise vibrate.
- i** If you are driving faster than 30 mph (47 km/h), you can no longer fold in the exterior mirrors.

### Resetting the exterior mirrors

If the battery has been disconnected or completely discharged, the exterior mirrors must be reset. The exterior mirrors will

otherwise not fold in when you select the "Fold in mirrors when locking" function in the on-board computer (▷ page 218).

- ▶ Make sure that the SmartKey is in position **1** in the ignition lock.
- ▶ Briefly press button **(1)**.

### Folding the exterior mirrors in or out automatically

If the "Fold in mirrors when locking" function is activated in the on-board computer (▷ page 218):

- the exterior mirrors fold in automatically as soon as you lock the vehicle from the outside.
- the exterior mirrors fold out again automatically as soon as you unlock the vehicle and then open the driver's or front-passenger door.

- i** The mirrors do not fold out if they have been folded in manually.

### Exterior mirror out of position

If an exterior mirror has been pushed out of position, proceed as follows:

- ▶ **Vehicles without electrically folding exterior mirrors:** move the exterior mirror into the correct position manually.
- ▶ **Vehicles with electrically folding exterior mirrors:** press the mirror-folding button (▷ page 102) repeatedly until you hear the mirror engage in position.  
The mirror housing is engaged again and you can adjust the exterior mirrors as usual (▷ page 101).

### Automatic anti-glare mirrors

#### **Warning!**

The auto-dimming function does not react if incoming light is not aimed directly at sensors in the interior rear view mirror.

The interior rear view mirror and the exterior rear view mirror on the driver's side do not react, for example, when transporting cargo which covers the rear window.

Light hitting the mirror(s) at certain angles (incident light) could blind you. As a result, you may not be able to observe traffic conditions and could cause an accident.

The rear-view mirror and the exterior mirror on the driver's side automatically go into anti-glare mode if the ignition is switched on and incident light from headlamps strikes the sensor in the rear-view mirror.

The mirrors do not go into anti-glare mode if reverse gear is engaged or the interior lighting is switched on.

### Parking position for the exterior mirror on the front-passenger side

#### Setting and storing the parking position

You can position the front-passenger side exterior mirror in such a way that you can see the rear wheel on that side as soon as you engage reverse gear. You can store this position.

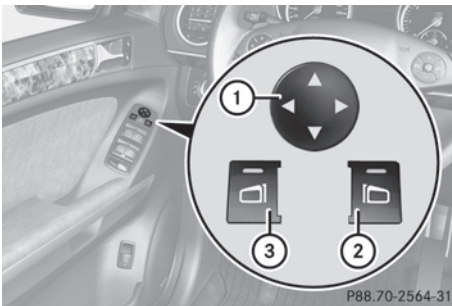

- ▶ Make sure that the vehicle is stationary and that the key is in position **2** in the ignition lock.
- ▶ Press button **2** for the exterior mirror on the front-passenger side.

- ▶ Engage reverse gear.  
The exterior mirror on the front-passenger side moves to the preset parking position.
- ▶ Use adjustment button **1** to adjust the exterior mirror to a position which allows you to see the rear wheel and the curb. The parking position is stored.

**i** If you shift the transmission to another position, the exterior mirror on the front-passenger side returns to the driving position.

#### Calling up a stored parking position setting

- ▶ With the key in position **2** in the ignition lock and the exterior mirror on the front-passenger side activated, engage reverse gear.  
The exterior mirror on the front-passenger side moves to the stored parking position.

The exterior mirror on the front-passenger side moves back to its original position:

- as soon as you exceed a speed of 6 mph (10 km/h)
- about ten seconds after you have disengaged reverse gear
- if you press button **3** for the exterior mirror on the driver's side

## Memory functions

### Storing settings

With the memory function, you can store up to three different settings, e.g. for three different people.

The following settings are stored as a single memory preset:

- position of the seat, backrest and head restraint
- driver's side: steering wheel position
- driver's side: position of the exterior mirrors on the driver's and front-passenger sides

### **Warning!**

The memory function can still be used when the key has been removed. For this reason, children should never be left unsupervised in the vehicle. They could otherwise become trapped when adjusting the seat or the steering wheel.

### **Warning!**

Only use the memory function on the driver's side when the vehicle is stationary. You could otherwise be distracted from the traffic conditions by the steering wheel and seat moving of their own accord, and as a result cause an accident.

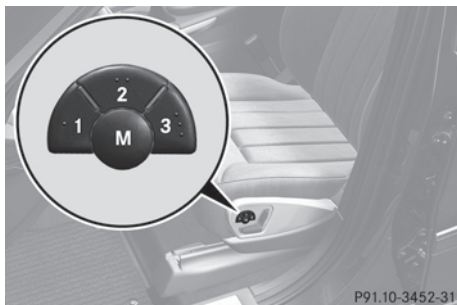

P91.10-3452-31

- ▶ Adjust the seat (> page 94).
- ▶ On the driver's side, adjust the steering wheel (> page 100) and the exterior mirrors (> page 101).
- ▶ Press memory button **M** and one of the storage position buttons **1**, **2** or **3** within three seconds.  
The settings are stored in the selected preset position. A tone sounds when the settings have been completed.

### Calling up a stored setting

- ▶ Press and hold the relevant storage position button **1**, **2** or **3**, until the seat, steering wheel and exterior mirrors are in the stored position.

- i** The setting procedure is interrupted as soon as you release the storage position button.

Vehicle equipment .....	106
Exterior lighting .....	106
Interior lighting .....	110
Changing bulbs .....	111
Windshield wipers .....	117

## Vehicle equipment

**i** This manual describes all the standard and optional equipment of your vehicle which was available at the time of purchase. Country-specific differences are possible. Bear in mind that your vehicle may not feature all functions described here. This also refers to safety-related systems and functions.

## Exterior lighting

### Important safety guidelines

For reasons of safety, Mercedes-Benz recommends that you drive with the lights switched on even during the daytime. In some countries, operation of the headlamps varies due to legal requirements and self-imposed obligations. In these countries, the daytime running lamps are automatically switched on when the engine is started.

### Notes on driving abroad

**Converting to symmetrical low beam when driving abroad:** switch the headlamps to symmetrical low beam in countries in which traffic drives on the opposite side of the road to the country where the vehicle is registered. This prevents oncoming traffic from being dazzled. Symmetrical lights do not illuminate as large an area of the edge of the carriageway.

Have the headlamps converted at a qualified specialist workshop, e.g. an authorized Mercedes-Benz Center, as close to the border as possible before driving in these countries.

**Converting to asymmetrical low beam after returning:** have the headlamps converted back to asymmetrical low beam at a qualified specialist workshop, e.g. an authorized Mercedes-Benz Center, as soon as possible after crossing the border when returning.

## Light switch

### Operation

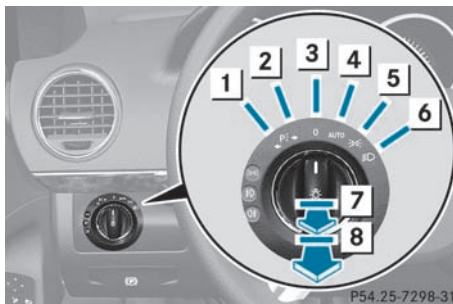

- |          |             |  |
|----------|-------------|--|
| <b>1</b> |             | Left-hand standing lamps                             |
| <b>2</b> |             | Right-hand standing lamps                            |
| <b>3</b> | <b>0</b>    | Lights off/daytime running lamps                     |
| <b>4</b> | <b>AUTO</b> | Automatic headlamp mode/daytime running lamps        |
| <b>5</b> |             | Parking lamps, license plate and instrument lighting |
| <b>6</b> |             | Low-beam/high-beam headlamps                         |
| <b>7</b> |             | Vehicles without front fog lamps: rear fog lamp      |
| <b>7</b> |             | Vehicles with fog lamps: front fog lamp              |
| <b>8</b> |             | Vehicles with fog lamps: rear fog lamp               |

The turn signals, high-beam headlamps and the high beam flasher are operated using the combination switch (▷ page 109).

**!** Switch off the parking lamps and standing lamps when you leave the vehicle. This prevents the battery from discharging.



The exterior lighting (except the parking lamps/standing lamps) switches off automatically if you:

- remove the key from the ignition lock
- open the driver's door with the key in position **0**

If you hear a warning tone when you leave the vehicle, the lights may still be switched on.

- ▶ Turn the light switch to **0** or **AUTO**.  
or
- ▶ If the rear fog lamp is switched on: press the light switch in to the stop.



### Low-beam headlamps

- ▶ **To switch on the low-beam headlamps:** turn the key in the ignition lock to position **2** or start the engine.
- ▶ Turn the light switch to .  
The  indicator lamp in the instrument cluster lights up.
- ▶ **To switch off the low-beam headlamps:** turn the light switch to **0**.

### Daytime running lamps

#### Daytime running lamps in Canada

In Canada, the "daytime running lamps" function is required by law. It can therefore not be deactivated.

- ▶ Turn the light switch to **0** or **AUTO**.  
With the engine running: depending on the ambient light, either the daytime running lamps or the low-beam headlamps are switched on.  
If the low-beam headlamps are switched on, the  indicator lamp on the light switch and the  indicator lamp in the instrument cluster light up.



If the light switch is set to **0** or **AUTO**, you cannot switch on the high-beam headlamps. Turn the light switch to  when driving at night. You can switch on the high-beam headlamps in this position.

With the engine running while the vehicle is stationary or if the parking brake is applied: the low-beam headlamps switch off after 3 minutes if you shift the selector lever to **P** from a driving position.

With the engine running while the vehicle is stationary: if you set the light switch to , the parking lamps and the low-beam headlamps switch on.



#### Daytime running lamps in the USA

The daytime running lamps are deactivated ex works on vehicles for the USA.

- ▶ **To switch on the daytime running lamps:** switch on the "daytime running lamps" function via the on-board computer (▷ page 215).
- ▶ Turn the light switch to **0** or **AUTO**.  
When the engine is running: the low-beam headlamps are switched on. The  indicator lamp on the light switch and the  indicator lamp in the instrument cluster light up.

You can only switch on the high-beam headlamps if there is little ambient light.

However, the headlamp flashers can always be applied.

If you set the light switch to  or  while the engine is running, the manual setting overrides the daytime running lamps.



#### Automatic headlamps

##### Warning!

If the light switch is set to **AUTO**, the low-beam headlamps will not come on automatically if it is foggy. This could endanger you and others. Therefore, turn the light switch to  in fog.

The automatic headlamp feature is only an aid. The driver is responsible for the vehicle's lighting at all times.

##### Warning

In low ambient lighting or foggy conditions, only switch from position **AUTO** to  with the vehicle at a standstill in a safe location. Switching from **AUTO** to  will briefly switch off the headlamps. Doing so while driving in low ambient lighting conditions may result in an accident.

- ▶ **To switch on automatic headlamp mode:** turn the light switch to **AUTO**.  
SmartKey in position **1** in the ignition lock: the parking lamps are switched on or off

automatically depending on the brightness of the ambient light.

With the engine running: depending on the brightness of the ambient light, the daytime running lamps<sup>12</sup> or the low-beam headlamps are switched on or off automatically.

When the low-beam headlamps are switched on, the  indicator lamp in the instrument cluster lights up.

## Fog lamps and rear fog lamps





### Front fog lamps



Only vehicles with front fog lamps have the "fog lamps" function.



#### Warning!

If you suspect that driving conditions will be foggy, turn the light switch to  before you start your journey. Otherwise, your vehicle may not be visible and you could endanger yourself and others.









#### Warning

In low ambient lighting or foggy conditions, only switch from position  to  with the vehicle at a standstill in a safe location. Switching from  to  will briefly switch off the headlamps. Doing so while driving in low ambient lighting conditions may result in an accident.

- ▶ **To switch on the front fog lamps:** turn the key in the ignition lock to position **2** or start the engine.
- ▶ Turn the light switch to  or . If the light switch is set to , you cannot switch on the fog lamps.

- ▶ Pull the light switch out to the first detent. The green  indicator lamp on the light switch lights up.
- ▶ **To switch off the front fog lamps:** press the light switch in as far as it will go. The green  indicator lamp on the light switch goes out.

### Rear fog lamp

- ▶ **To switch on (vehicles with front fog lamps):** turn the key in the ignition lock to position **2** or start the engine.
- ▶ Turn the light switch to  or . When the light switch is set to , you cannot switch on the rear fog lamp.
- ▶ Pull the light switch out to the second stop. The yellow  indicator lamp on the light switch lights up.
- ▶ **To switch off the rear fog lamp:** press the light switch in as far as it will go. The yellow  indicator lamp on the light switch goes out.
- ▶ **To switch on (vehicles without front fog lamps):** turn the key in the ignition lock to position **2** or start the engine.
- ▶ Turn the light switch to . When the light switch is set to , you cannot switch on the rear fog lamp.
- ▶ Pull the light switch out to the stop. The yellow  indicator lamp on the light switch lights up.
- ▶ **To switch off the rear fog lamp:** press the light switch in as far as it will go. The yellow  indicator lamp on the light switch goes out.

<sup>12</sup> Only if daytime running lamps have been activated via the on-board computer.

## Combination switch

### Turn signals

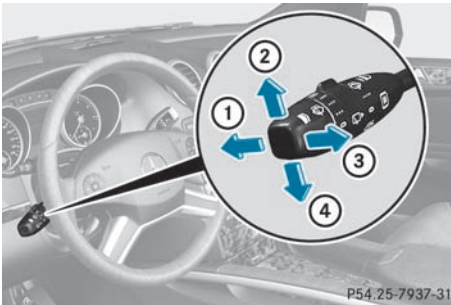

- ① High-beam headlamps
- ② Right turn signal
- ③ High beam flasher
- ④ Left turn signal

► **To indicate briefly:** press the combination switch briefly to the pressure point in the direction of arrow ② or ④.

The corresponding turn signal flashes three times.

► **To indicate:** press the combination switch beyond the pressure point in the direction of arrow ② or ④.

### High-beam headlamps

► **To switch on the high-beam headlamps:** turn the key in the ignition lock to position **2** or start the engine.

► Turn the light switch to .

► Press the combination switch beyond the pressure point in the direction of arrow ①.

The  indicator lamp in the instrument cluster lights up.

► **To switch off the high-beam headlamps:** move the combination switch back to its normal position.

The  indicator lamp in the instrument cluster goes out.

### High beam flasher

- **To switch on:** turn the key in the ignition lock to position **1** or **2** or start the engine.
- Pull the combination switch briefly in the direction of arrow ③.

### Hazard warning lamps



The hazard warning lamps automatically switch on:

- if an air bag is deployed
- the vehicle decelerates rapidly from a speed of more than 45 mph (70 km/h) and comes to a standstill.

► **To switch on the hazard warning lamps:** press button ①.

All turn signals flash. If you now switch on a turn signal using the combination switch, only the turn signal lamp on the corresponding side of the vehicle will flash.

► **To switch off the hazard warning lamps:** press button ①.

The hazard warning lamp switches off automatically after full brake application if the vehicle then reaches a speed above 6 mph (10 km/h) again.

**i** The hazard warning lamps still operate if the ignition is switched off.

### Headlamp cleaning system

The headlamps are cleaned automatically if the "Wipe with washer fluid" function is

operated five times while the lights are on and the engine is running (▷ page 117). When you switch off the ignition, the automatic headlamp cleaning system is reset and counting is resumed from 0.

### Cornering light function (Bi-Xenon headlamps)



The cornering light function improves the illumination of the road over a wide angle in the direction you are turning, enabling better visibility in tight bends, for example. It can only be activated when the low-beam headlamps are switched on.

**Active:** if you are driving at speeds below 25 mph (40 km/h) and switch on the turn signals or turn the steering wheel.

**Not active:** if you are driving at speeds above 25 mph (40 km/h) or switch off the turn signal or turn the steering wheel to the straight-ahead position.

The cornering light function may remain lit for a short time, but is automatically switched off after no more than three minutes.

### Headlamps fogged up on the inside

The headlamps may fog up on the inside if there is high atmospheric humidity.

- ▶ Drive with the headlamps switched on. The headlamps clear up after a short distance.

If the moisture does not disappear, the headlamp casing is not sealed correctly and moisture has been able to enter.



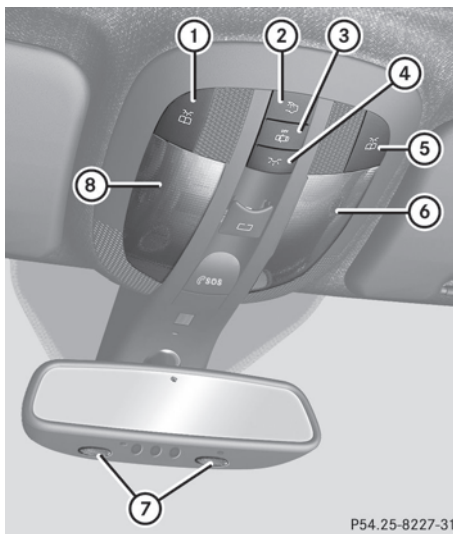

- ▶ Have the headlamps checked at a qualified specialist workshop.

## Interior lighting

### Overview of interior lighting



Overhead control panel

- ①  To switch the left-hand front reading lamp on/off
- ②  To switch the rear interior lighting on/off
- ③  To switch the automatic interior lighting control on/off
- ④  To switch the front interior lighting on/off
- ⑤  To switch the right-hand front reading lamp on/off
- ⑥ Front interior lighting
- ⑦ Front reading lamps
- ⑧ Front interior lighting

### Automatic interior lighting control

- ▶ **To switch on/off:** press the  button. When the automatic interior lighting control is activated, the button is flush with the overhead control panel.

The interior lighting automatically switches on if you:

- unlock the vehicle
- open a door
- remove the key from the ignition lock .

The interior lighting delayed switch-off must be activated (▶ page 217)

The interior lighting switches off after a delay. You can set the delayed switch-off using the on-board computer.



- i** The interior lighting switches off automatically after five minutes in certain conditions. This is the case when a door stays open and the key in the ignition lock is in position **0** or is removed.

### Manual interior lighting control

- !** If the interior lighting has been switched on manually, it will not be switched off automatically.

This can cause the battery to discharge.

Make sure that the interior lighting does not remain switched on too long after the engine has been switched off.

- ▶ **To switch the front interior lighting on/off:** press the  button.
- ▶ **To switch the rear interior lighting on/off:** press the  button.
- ▶ **To switch the reading lamps on/off:** press the  button.

### Crash-responsive emergency lighting

The interior lighting is activated automatically if the vehicle is involved in an accident.

- ▶ **To switch off the crash-responsive emergency lighting:** press the hazard warning lamp button.

or

- ▶ Lock and then unlock the vehicle using the key.

## Changing bulbs

### Important safety guidelines

#### Xenon bulbs

If your vehicle is equipped with Xenon bulbs, you can recognize this by the following: the cone of light from the Xenon bulbs moves from the top to the bottom and back again when you start the engine. For this to be observed, the lights must be switched on before starting the engine.

#### **Warning!**

Xenon bulbs carry a high voltage. You could get an electric shock and be seriously or even fatally injured if you touch the electric contacts on Xenon bulbs. Therefore, never remove the cover from Xenon bulbs.

Do not change Xenon bulbs yourself, but have them replaced at a qualified specialist workshop which has the necessary specialist knowledge and tools to carry out the work required.

Mercedes-Benz recommends that you use an authorized Mercedes-Benz Center for this purpose. In particular, work relevant to safety or on safety-related systems must be carried out at a qualified specialist workshop.

Bulbs and lamps are an important aspect of vehicle safety. You must therefore make sure that these function correctly at all times. Have the headlamp setting checked regularly.

## Other bulbs

### Warning!

Bulbs and lamps can be very hot. You should therefore allow them to cool down before you change them. Otherwise, you could be burned if you touch them.

Keep bulbs out of the reach of children. Otherwise, they could damage the bulbs, for example, and injure themselves.

Never use a bulb which has been dropped. Such a bulb may break or even explode and injure you.

Halogen bulbs are pressurized and can explode when you change them, particularly if they are very hot. You should therefore wear eye protection and gloves when you are changing them.

There are bulbs other than the Xenon bulbs that you cannot replace. Replace only the bulbs listed (> page 112). Have the bulbs that you cannot replace yourself changed at a qualified specialist workshop.

Mercedes-Benz recommends that you use an authorized Mercedes-Benz Center for this purpose. In particular, work relevant to safety or on safety-related systems must be carried out at a qualified specialist workshop.

If you require assistance changing bulbs, consult a qualified specialist workshop.

Do not touch the glass tube of new bulbs with your bare hands. Even minor contamination can burn into the glass surface and reduce the service life of the bulbs. Always use a lint-free cloth or only touch the base of the bulb when installing.

Only use bulbs of the correct type.

If the new bulb still does not light up, consult a qualified specialist workshop.

Bulbs and lamps are an important aspect of vehicle safety. You must therefore make sure that these function correctly at all times.

Have the headlamp setting checked regularly.

## Overview: changing bulbs/bulb types

You can change the following bulbs. The bulb type can be found in the legend.

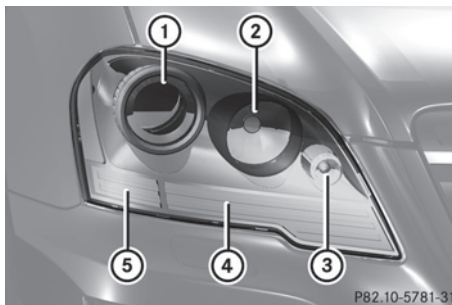

### Halogen headlamps

- ① Low-beam headlamp: H7 55 W
- ② High-beam headlamp: H7 55 W
- ③ Parking lamp/standing lamp: W 5 W
- ④ Turn signal lamp: 3457A
- ⑤ Side marker lamp: WY 5 W

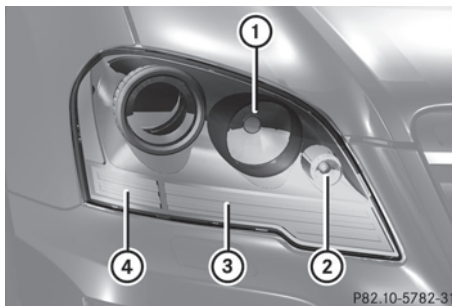

### Bi-Xenon headlamps

- ① High-beam headlamp: H7 55 W
- ② Parking lamp/standing lamp: W 5 W
- ③ Turn signal lamp: 3457A
- ④ Side marker lamp: WY 5 W

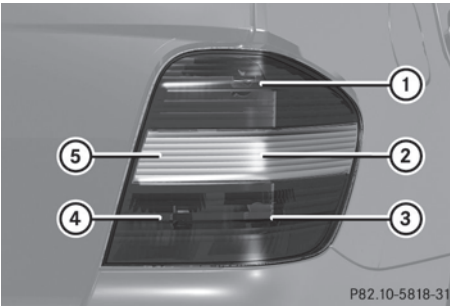

Tail lamps without LEDs

- ① Brake lamp: P 21 W
- ② Turn signal lamp: PY 21 W
- ③ Side marker lamp: P 21 W
- ④ Tail lamp/standing lamp/parking lamp/rear fog lamp (driver's side only): P 21 W
- ⑤ Backup lamp: P 21 W

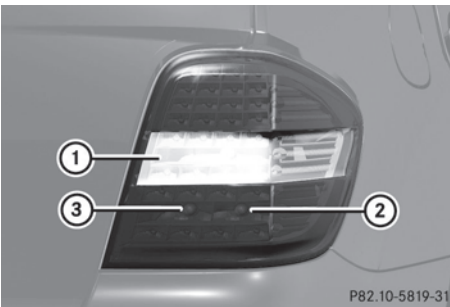

Tail lamps with LEDs

- ① Backup lamp: W 16 W
- ② Rear fog lamp: W 16 W (driver's side only)
- ③ Rear fog lamp: W 16 W (driver's side only)

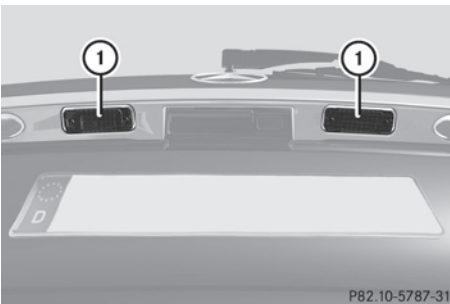

License plate lamp

- ① License plate lamp: W 5 W

### Changing the front bulbs

#### Low-beam headlamp (halogen headlamp)

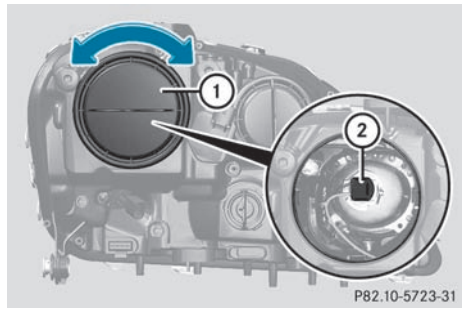

- ▶ Switch off the lights.
- ▶ Open the hood.
- ▶ Turn housing cover ① counter-clockwise and pull it out.
- ▶ Turn bulb holder ② counter-clockwise and pull it out.
- ▶ Take the bulb out of bulb holder ②.
- ▶ Insert the new bulb into bulb holder ②.
- ▶ Insert bulb holder ② into the lamp and turn it clockwise.
- ▶ Align housing cover ① and turn it clockwise until it engages.

#### High-beam headlamps

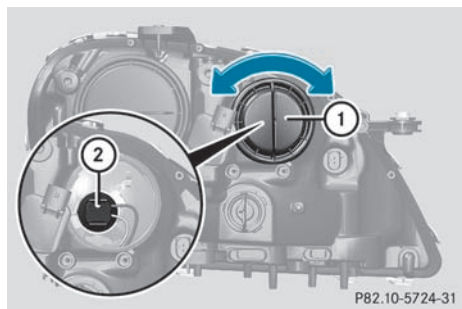

- ▶ Switch off the lights.
- ▶ Open the hood.
- ▶ Turn housing cover ① counter-clockwise and pull it out.

- ▶ Turn bulb holder ② counter-clockwise and pull it out.
- ▶ Take the bulb out of bulb holder ②.
- ▶ Insert the new bulb into bulb holder ②.
- ▶ Insert bulb holder ② into the lamp and turn it clockwise.
- ▶ Align housing cover ① and turn it clockwise until it engages.

## Standing lamps/parking lamps

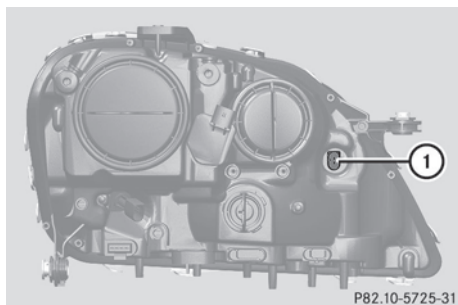

- ▶ Switch off the lights.
- ▶ Open the hood.
- ▶ Turn bulb holder ① counter-clockwise and pull it out.
- ▶ Take the bulb out of bulb holder ①.
- ▶ Insert the new bulb into bulb holder ①.
- ▶ Insert bulb holder ① into the lamp and turn it clockwise.

## Turn signal lamps/side marker lamps

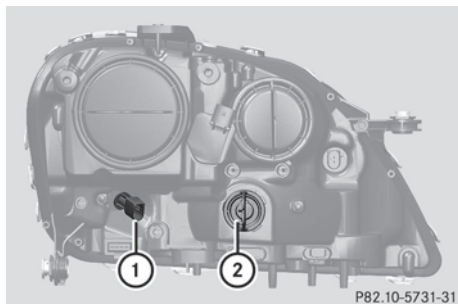

- ▶ Switch off the lights.
- ▶ Open the hood.

## Changing the rear bulbs

### Opening/closing the side trim

You must open the side trim panel in the cargo compartment before you can change the bulbs in the tail lamps.

#### Left-hand side trim panel

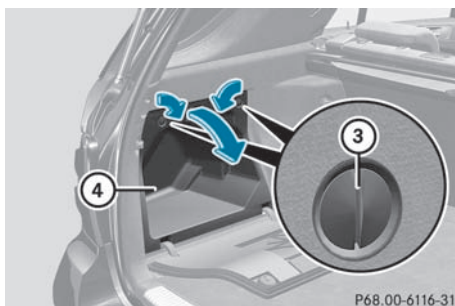
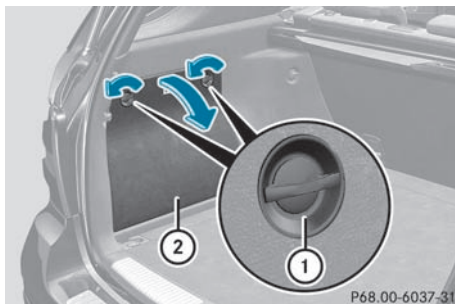

- ▶ **To open:** turn release knobs ① 90° in the direction of the arrow and remove side trim panel ②.
- ▶ Insert a suitable object, e.g. a coin, into the slots of release knobs ③.

- ▶ Turn release knobs ③ 90° in the direction of the arrow and remove stowage compartment ④.
- ▶ **To close:** insert stowage compartment ④ and turn release knobs ③ in the opposite direction to the arrow until the slots on the release knobs are in a vertical position.
- ▶ Insert side trim panel ② and turn release knobs ① 90° in the opposite direction to the arrow.

**Right-hand side trim panel**

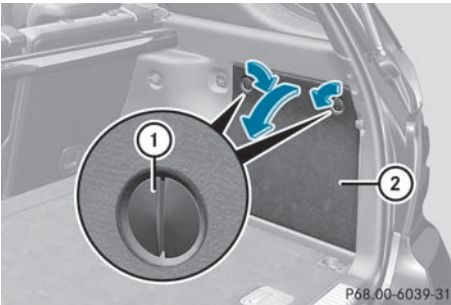

- ▶ **To open:** insert a suitable object, e.g. a coin, into the slots of release knobs ① on side trim panel ②.
- ▶ Turn release knobs ① 90° in the direction of the arrow and remove side trim panel ②.
- ▶ **To close:** insert side trim panel ② and turn release knobs ① 90° in the opposite direction to the arrow.

**Tail lamps without LEDs**

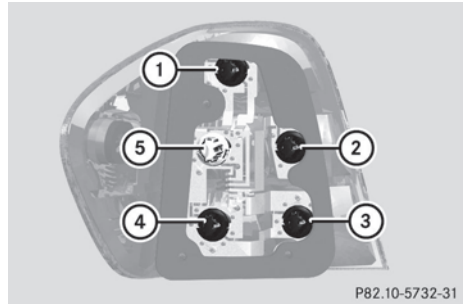

P82.10-5732-31

- ① Brake lamp
- ② Backup lamp
- ③ Fog lamp (left)/tail lamps/standing lamps/parking lamps
- ④ Side marker lamp
- ⑤ Turn signals
- ▶ Switch off the lights.
- ▶ Open the cargo compartment.
- ▶ Open the side trim panel (▷ page 114).
- ▶ Turn the corresponding bulb holder counter-clockwise and remove it.
- ▶ Remove the bulb from the bulb holder.
- ▶ Insert the new bulb into the bulb holder.
- ▶ Insert the bulb holder and turn it clockwise.
- ▶ Close the side trim panel (▷ page 114).

**Tail lamps with LEDs**

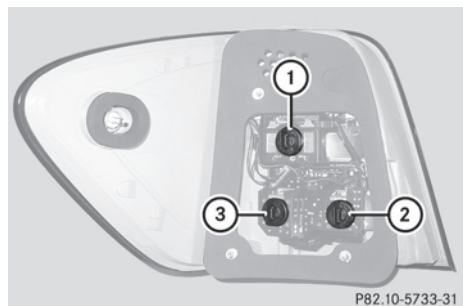

P82.10-5733-31

- ① Backup lamp
- ② Rear fog lamp
- ③ Rear fog lamp

- ▶ Switch off the lights.
- ▶ Open the cargo compartment.
- ▶ Open the side trim panel (▷ page 114).
- ▶ Turn the corresponding bulb holder counter-clockwise and remove it.
- ▶ Remove the bulb from the bulb holder.
- ▶ Insert the new bulb into the bulb holder.
- ▶ Insert the bulb holder and turn it clockwise.
- ▶ Close the side trim panel (▷ page 114).

### License plate lamp

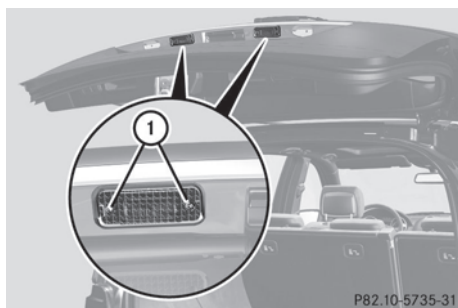

- ▶ Switch off the lights.
- ▶ Open the tailgate.
- ▶ Remove screws ①.
- ▶ Remove the license plate lamp.
- ▶ Replace the bulb.
- ▶ Insert the license plate lamp.
- ▶ Replace and tighten screws ①.

### Setting the headlamps

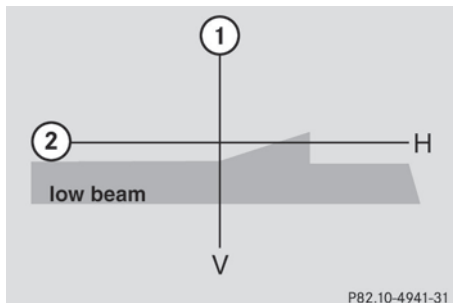

- ① V vertical axis
- ② H (horizontal) height, measured from the center

Setting the headlamps correctly is extremely important. Setting the high-beam headlamps also sets the low-beam headlamps. (The term headlamps covers both high and low beam.) To check and adapt the headlamp setting, proceed as follows:

- ▶ Park the vehicle on level ground at a distance of 25 feet (7.6 m) from a wall or similar.
- ▶ Make sure that the vehicle load is in the normal range.
- ▶ Switch on the  low-beam headlamps.

If the light of the headlamps is not distributed as shown in the illustration above, follow the instructions below:

- ▶ Open the hood (▷ page 282).

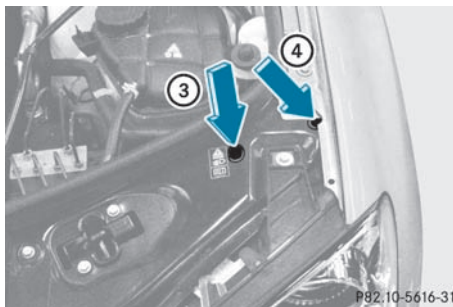

The adjustment screws are located under the cover.

- ▶ Insert a suitable tool into the openings in the cover. The directions of arrow ③ and ④ indicate the angle at which the tool needs to be inserted in order to reach the adjustment screws.
- ▶ Turn both screws uniformly until the vertical setting corresponds to ①. Turn the screws clockwise to adjust the headlamp upwards and counterclockwise to adjust it downwards.

Gradation:

- Screw at arrow ③: 0.67° angle of inclination
- Screw at arrow ④: 0.50° angle of inclination

The left and right headlamp need to be adjusted individually.

- i** If it is not possible to adjust the headlamps accurately, have the adjustment performed at an authorized Mercedes-Benz Center.

## Windshield wipers

### Important safety guidelines

#### **Warning!**

Wiper blades are components that are subject to wear and tear. Replace the wiper blades twice a year, preferably in the spring and fall. Otherwise the windows will not be wiped properly. As a result, you may not be able to observe surrounding traffic conditions and could cause an accident.





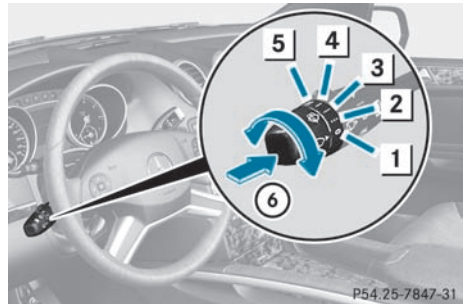

- !** Do not operate the windshield wipers when the windshield is dry, as this could damage the wiper blades. Moreover, dust that has collected on the windshield/rear window can scratch the glass if wiping takes place when the windshield/rear window is dry.

If it is necessary to switch on the windshield wipers in dry weather conditions, always use washer fluid when operating the windshield wipers.

### Switching the windshield wipers on/off





Combination switch

- 1  Windshield wipers off
- 2  Intermittent wipe, low<sup>13</sup>
- 3  Intermittent wipe, high<sup>14</sup>
- 4  Continuous wipe, slow
- 5  Continuous wipe, fast
- 6  Single wipe/  To wipe the windshield using washer fluid

- ▶ Switch on the ignition.
- ▶ Turn the combination switch to the corresponding position.

- !** Intermittent wiping with rain sensor: due to optical influences and the windshield becoming dirty in dry weather conditions, the windshield wipers may be activated inadvertently. This could then damage the windshield wiper blades or scratch the windshield.

For this reason, you should always switch off the windshield wipers in dry weather.

In the  or  position, the appropriate wiping frequency is set automatically according to the intensity of the rain. In

<sup>13</sup> Rain sensor set to low sensitivity.

<sup>14</sup> Rain sensor set to high sensitivity.

the **....** position, the rain sensor is more sensitive than in the **...** position, causing the windshield wiper to wipe more frequently. Intermittent wiping is interrupted when you stop the vehicle and open a front door. This prevents a person from being splashed inadvertently when getting into or out of the vehicle.

Intermittent wiping continues when all doors are closed and

- you shift the automatic transmission to drive position **D** or reverse gear **R** or
- you change the wipe setting on the combination switch.

**i** To prevent smearing on the windshield or noise when wiping, wipe the windshield occasionally with washer fluid.

### Switching the rear window wiper on/off

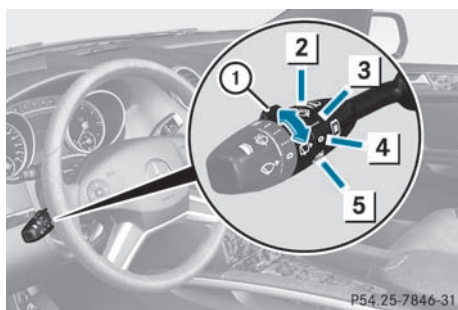

Combination switch

- ① Switch
- ② To wipe with washer fluid
- ③ To switch on intermittent wiping
- ④ To switch off intermittent wiping
- ⑤ To wipe with washer fluid

- ▶ Turn the key to position **1** or **2** in the ignition lock.
- ▶ Turn switch ① on the combination switch to the corresponding position. When the rear window wiper is switched on, the icon appears in the instrument cluster.

### Replacing the wiper blades

#### Important safety guidelines

##### Warning

For safety reasons, switch off the windshield wipers and remove the key from the ignition lock before changing the wiper blades (vehicles with KEYLESS-GO: make sure that the on-board electronics are in state **0**). Otherwise, the wiper motor could be switched on suddenly and cause injury.

- !** To avoid damaging the wiper blades, make sure that you touch only the wiper arm of the wiper.
- !** Never open the hood if a windshield wiper arm has been folded away from the windshield. Never fold a windshield wiper arm without a wiper blade back onto the windshield. Hold the windshield wiper arm firmly when you change the wiper blade. If you release the windshield wiper arm without a wiper blade and it falls onto the windshield, the windshield can be damaged by the force of the impact. Mercedes-Benz recommends that you have the wiper blades replaced by a qualified specialist workshop, e.g. at an authorized Mercedes-Benz Center.

## Replacing the windshield wiper blades

### Removing the wiper blades

- ▶ Remove the SmartKey from the ignition lock.
- ▶ Fold the wiper arm away from the windshield.

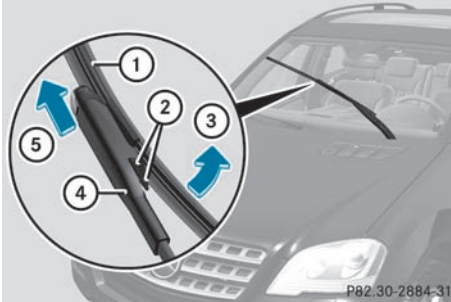

- ▶ Press both release clips (2).
- ▶ Fold wiper blade (1) in the direction of arrow (3) away from wiper arm (4).
- ▶ Remove wiper blade (1) in the direction of arrow (5).

### Installing the wiper blades

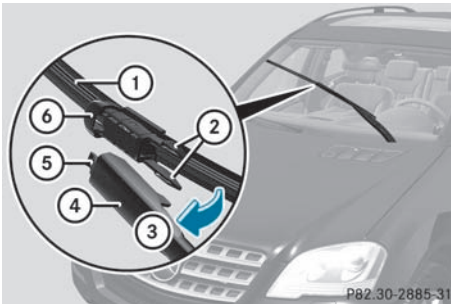

- ▶ Position the new wiper blade (1) with recess (6) on lug (5).
- ▶ Fold wiper blade (1) in the direction of arrow (3) onto the wiper arm, until retaining clips (2) engage in bracket (4).
- ▶ Make sure that wiper blade (1) is seated correctly.
- ▶ Fold the wiper arm back onto the windshield.

## Replacing the rear window wiper blade

### ⚠ Warning

The wiper arm could be set in motion and injure you if the windscreen wipers are switched on.

Remove the key from the ignition lock before replacing the wiper blade.

### Removing the wiper blade

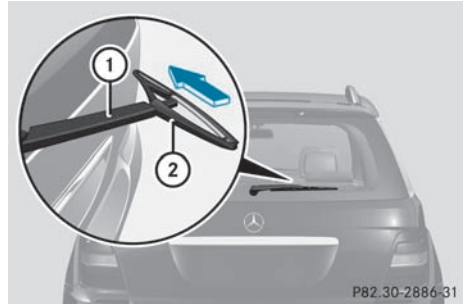

- ▶ Remove the key from the ignition lock.
- ▶ Fold wiper arm (1) away from the rear window until it engages.
- ▶ Position wiper blade (2) at a right angle to wiper arm (1).
- ▶ Hold wiper arm (1) and press wiper blade (2) in the direction of the arrow until it is released.
- ▶ Remove wiper blade (2).

### Installing the wiper blade

- ▶ Place new wiper blade (2) onto wiper arm (1).
- ▶ Hold wiper arm (1) and press wiper blade (2) in the opposite direction to the arrow until it engages.
- ▶ Make sure that wiper blade (2) is seated correctly.
- ▶ Position wiper blade (2) parallel to wiper arm (1).
- ▶ Fold wiper arm (1) back onto the rear window.

**Problems with the windshield wipers****The windshield wipers are obstructed**

Leaves or snow, for example, may be obstructing the windshield wiper movement. The wiper motor has been deactivated.

- ▶ For safety reasons, you should remove the key from the ignition lock.

or

- ▶ Switch off the engine using the Start/Stop button and open the driver's door.
- ▶ Remove the cause of the obstruction.
- ▶ Switch the windshield wipers back on.

**The windshield wipers are not working**

The windshield wiper drive is malfunctioning.

- ▶ Select another wiper speed on the combination switch.
- ▶ Have the windshield wipers checked at a qualified specialist workshop.

<b>Vehicle equipment .....</b>	<b>122</b>
<b>Overview of climate control systems .....</b>	<b>122</b>
<b>Operating the control systems .....</b>	<b>128</b>
<b>Setting the air vents .....</b>	<b>134</b>

## Vehicle equipment

**i** This manual describes all the standard and optional equipment of your vehicle which was available at the time of purchase. Country-specific differences are possible. Bear in mind that your vehicle may not feature all functions described here. This also refers to safety-related systems and functions.

## Overview of climate control systems

### Important safety guidelines

#### Warning

Severe conditions (e.g. strong air pollution) may require replacement of the filter before its scheduled replacement interval. A clogged filter will reduce the air volume to the interior and the windows could fog up, impairing visibility and endangering you and others. Have a clogged filter replaced as soon as possible at an authorized Mercedes-Benz Center.

#### Warning

Follow the recommended settings for heating and cooling given on the following pages. Otherwise, the windows could fog up, impairing visibility and endangering you and others.

Dual-zone automatic climate control/multi-zone automatic climate control<sup>15</sup> controls the temperature and the humidity of the vehicle interior and filters out undesirable substances from the air.

Dual-zone automatic climate control/multi-zone automatic climate control<sup>15</sup> is only operational when the engine is running<sup>16</sup>. Optimum operation is only achieved when you drive with the side windows and tilt/sliding sunroof closed.

<sup>15</sup> For Canada only.

<sup>16</sup> The "residual heat" function can only be switched on/off when the ignition is switched off.

- i** Ventilate the vehicle for a brief period during warm weather, e.g. using the convenience opening feature (> page 86). This will speed up the cooling process and the desired vehicle interior temperature will be reached more quickly.
- i** The integrated filter can filter out most particles of dust and completely filters out pollen. A clogged filter reduces the amount of air supplied to the vehicle interior. For this reason, you should always observe the interval for replacing the filter, which is specified in the Service Booklet. As it depends on environmental conditions, e.g. heavy air pollution, the interval may be shorter than stated in the Service Booklet.

Control panel for the dual-zone automatic climate control

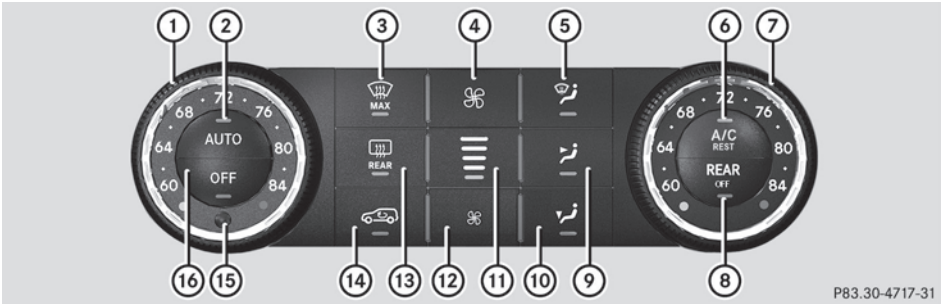

P83.30-4717-31

	Function	i Notes/tips
①	Sets the temperature, left	Set the temperature to 72 °F (22 °C).
②	Sets climate control to automatic	Activate climate control using the <b>AUTO</b> and <b>A/C REST</b> buttons. The indicator lamps in the <b>AUTO</b> and <b>A/C REST</b> buttons light up.
③	Defrosts the windshield	Only use the "defrosting" function briefly until the windshield is clear again.
④	Increases the airflow	
⑤	Directs the airflow through the defroster vents	
⑥	Switches cooling with air dehumidification on/off	Activate climate control using the <b>AUTO</b> and <b>A/C REST</b> buttons. The indicator lamps in the <b>AUTO</b> and <b>A/C REST</b> buttons light up.
	Switches the residual heat function on/off	Use the residual heat function if you want to heat or ventilate the vehicle interior when the ignition is switched off. The "residual heat" function can only be activated or deactivated with the ignition switched off.
⑦	Sets the temperature, right	Set the temperature to 72 °F (22 °C).
⑧	Switches rear-compartment climate control on/off	
⑨	Directs the airflow through the center and side air vents	
⑩	Directs the airflow to the footwells and side air vents	
⑪	Displays the airflow level	
⑫	Reduces the airflow	

	Function	Notes/tips
⑬	Switches the rear window heating on/off	
⑭	Activates/deactivates air-recirculation mode	Only use "air-recirculation" mode briefly, e.g. if there are unpleasant outside odors or when in a tunnel. The windows could otherwise fog up as, in air-recirculation mode, no fresh air is drawn into the vehicle.
⑮	Interior temperature sensor	
⑯	Switches climate control on/off	Activate climate control using the <b>AUTO</b> and <b>A/C REST</b> buttons. The indicator lamps in the <b>AUTO</b> and <b>A/C REST</b> buttons light up.



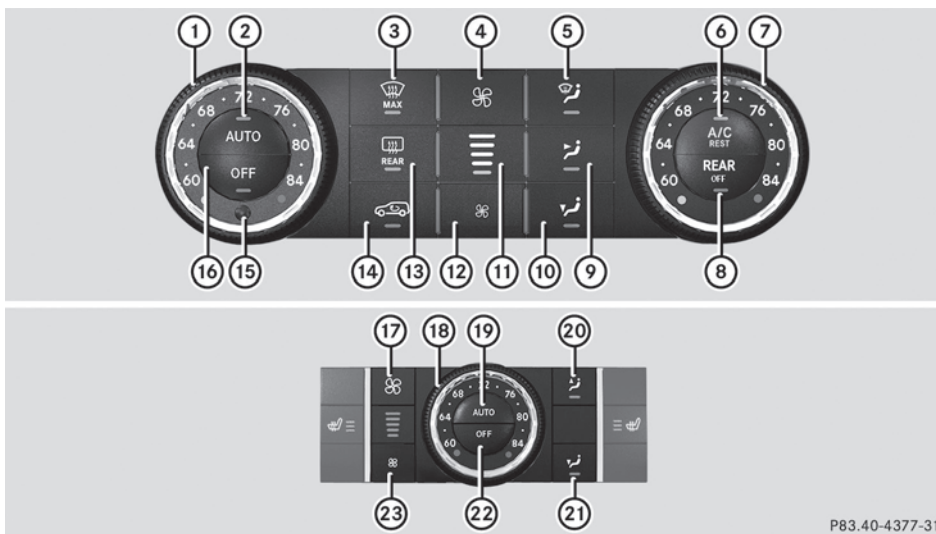





Control panel for the multi-zone automatic climate control



P83.40-4377-31

For USA only

	Function	Notes/tips
<b>Front control panel</b>		
①	Sets the temperature, left	Set the temperature to 72 °F (22 °C).
②	Sets climate control to automatic	Activate climate control using the <b>AUTO</b> and <b>A/C REST</b> buttons. The indicator lamps in the <b>AUTO</b> and <b>A/C REST</b> buttons light up.

	Function	 Notes/tips
③	Defrosts the windshield	Only use the "defrosting" function briefly until the windshield is clear again.
④	Increases the airflow	
⑤	Directs the airflow through the defroster vents	
⑥	Switches cooling with air dehumidification on/off	Activate climate control using the  and  buttons. The indicator lamps in the  and  buttons light up.
	Switches the residual heat function on/off	Use the residual heat function if you want to heat or ventilate the vehicle interior when the ignition is switched off. The "residual heat" function can only be activated or deactivated with the ignition switched off.
⑦	Sets the temperature, right	Set the temperature to 72 °F (22 °C).
⑧	Switches rear-compartment climate control on/off	
⑨	Directs the airflow through the center and side air vents	
⑩	Directs the airflow to the footwells and side air vents	
⑪	Displays the airflow level	
⑫	Reduces the airflow	
⑬	Switches the rear window heating on/off	
⑭	Activates/deactivates air-recirculation mode	Only use "air-recirculation" mode briefly, e.g. if there are unpleasant outside odors or when in a tunnel. The windows could otherwise fog up as, in air-recirculation mode, no fresh air is drawn into the vehicle.
⑮	Interior temperature sensor	
⑯	Switches climate control on/off	Activate climate control using the  and  buttons. The indicator lamps in the  and  buttons light up.
<b>Rear control panel</b>		
⑰	Increases the airflow	



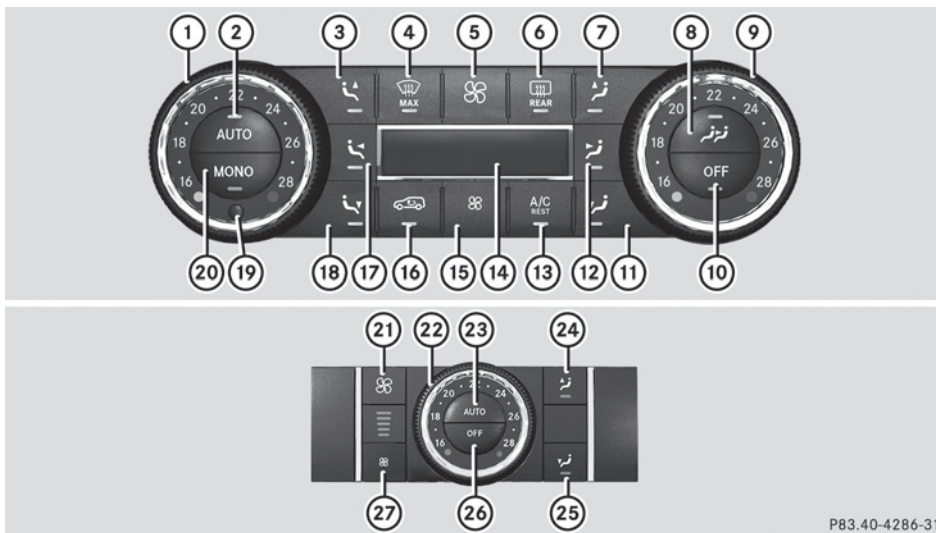





	Function	Notes/tips
18	Sets the temperature	Set the temperature to 72 °F (22 °C).
19	Sets the rear-compartment climate control to automatic	
20	Directs the airflow through the rear air vents	
21	Directs the airflow through the footwell vents	
22	Switches rear-compartment climate control on/off	
23	Reduces the airflow	



P83.40-4286-31

For Canada only

	Function	Notes/tips
<b>Front control panel</b>		
1	Sets the temperature, left	Set the temperature to 72 °F (22 °C).
2	Sets climate control to automatic	Activate climate control using the <b>AUTO</b> and <b>A/C REST</b> buttons. The indicator lamps in the <b>AUTO</b> and <b>A/C REST</b> buttons light up.
3	Directs the airflow through the defroster vents, left	

	Function	 Notes/tips
④	Defrosts the windshield	Only use the "defrosting" function briefly until the windshield is clear again.
⑤	Increases the airflow	
⑥	Switches the rear window heating on/off	
⑦	Directs the airflow through the defroster vents, right	
⑧	Operates the rear-compartment climate control via the front control panel	
⑨	Sets the temperature, right	Set the temperature to 72 °F (22 °C).
⑩	Switches climate control on/off	Activate climate control using the  and  buttons. The indicator lamps in the  and  buttons light up.
⑪	Directs the airflow to the footwells and side air vents, right	
⑫	Directs the airflow through the center and side air vents, right	
⑬	Switches cooling with air dehumidification on/off	Activate climate control using the  and  buttons. The indicator lamps in the  and  buttons light up.
	Switches the residual heat function on/off	Use the residual heat function if you want to heat or ventilate the vehicle interior when the ignition is switched off. The "residual heat" function can only be activated or deactivated with the ignition switched off.
⑭	Display	
⑮	Reduces the airflow	
⑯	Activates/deactivates air-recirculation mode	
⑰	Directs the airflow through the center and side air vents, left	
⑱	Directs the airflow to the footwells and side air vents, left	

	Function	 Notes/tips
⑰	Interior temperature sensor	
⑱	Switches the MONO function on/off	Use the MONO function if you want to adopt the temperature, air distribution and airflow settings from the driver's side for all climate control zones. The indicator lamp in the <b>MONO</b> button lights up.
<b>Rear control panel</b>		
⑳	Increases the airflow	
㉑	Sets the temperature	Set the temperature to 72 °F (22 °C).
㉒	Sets the rear-compartment climate control to automatic	
㉓	Directs the airflow through the rear air vents	
㉔	Directs the airflow through the footwell vents	
㉕	Switches rear-compartment climate control on/off	
㉖	Reduces the airflow	

## Operating the control systems

### Switching the control on/off

#### Important information

#### Warning!



When the climate control system is deactivated, the outside air supply and circulation are also deactivated. Only choose this setting for a short time. Otherwise the windows could fog up, impairing visibility and endangering you and others.

-  Activate climate control primarily using the **AUTO** button (▷ page 130).

#### Activating/deactivating the front climate control using the front control panel



- ▶ Turn the key to position **2** in the ignition lock.
  - ▶ **To activate:** press the **AUTO** button. The indicator lamp in the **AUTO** button lights up. Airflow and air distribution are set to automatic mode.
- or
- ▶ Press the **OFF** button. The indicator lamp in the **OFF** button goes out. The previously selected settings come into effect again.
  - ▶ **To deactivate:** press the **OFF** button. The indicator lamp in the **OFF** button lights up.

### Activating/deactivating the rear-compartment climate control using the front control panel (dual-zone automatic climate control)







- ▶ Turn the key to position **2** in the ignition lock.
- ▶ **To activate/deactivate:** press the  button (▷ page 123).  
The indicator lamp in the  button lights up or goes out.

### Activating/deactivating the rear-compartment climate control using the front control panel (multi-zone automatic climate control)





For USA only:

- ▶ Turn the key to position **2** in the ignition lock.
- ▶ **To activate/deactivate:** press the  button (▷ page 124).  
The indicator lamp in the  button lights up or goes out.

For Canada only:

- ▶ Turn the key to position **2** in the ignition lock.
- ▶ **To activate:** press the  button (▷ page 124).  
ON and MODE are shown in the multi-zone automatic climate control display behind the  symbol. The MODE display goes out after three seconds. The display switches back to the standard display.
- ▶ **To deactivate:** press the  button (▷ page 124).  
MODE is shown in the display behind the  symbol.
- ▶ Press the  button (▷ page 124).  
OFF is shown in the display behind the  symbol.

### Activating/deactivating the rear-compartment climate control using the rear control panel (multi-zone automatic climate control)

- ▶ Turn the key to position **2** in the ignition lock.
- ▶ Activate multi-zone automatic climate control with the front control panel.
- ▶ **To activate:** press the  button.  
The indicator lamp in the  button lights up.
- ▶ **To deactivate:** press the  button.  
The indicator lamp in the  button lights up.

### Switching cooling with air dehumidification on/off

#### Important information

The cooling with air dehumidification function is only available when the engine is running. The air inside the vehicle is cooled and dehumidified according to the temperature selected.

#### Warning

If you switch off the cooling function, the vehicle will not be cooled when weather conditions are warm. The windows can fog up more quickly. Window fogging may impair visibility and endanger you and others.



Condensation may drip from the underside of the vehicle when automatic climate control is in cooling mode. This is normal and not a sign that there is a malfunction.



- ❗ The cooling with air dehumidification function uses refrigerant R134a. This coolant does not contain chlorofluorocarbons, and therefore does not damage the ozone layer.

## Activating/deactivating

**!** If the cooling with air dehumidification does not switch on, it is possible that the climate control system has lost coolant.

Have the cooling with air dehumidification checked at a qualified specialist workshop.

▶ **To switch on:** press the  button. The indicator lamp in the  button lights up.

▶ **To switch off:** press the  button. The indicator lamp in the  button goes out. The cooling with air dehumidification function has a delayed switch-off feature.

## Problems with the "cooling with air dehumidification" function

If the indicator lamp in the  button does not go out when switched off, the cooling with air dehumidification function is switched off due to a malfunction. You can no longer activate the cooling with air dehumidification function.

▶ Consult a qualified specialist workshop.

## Setting climate control to automatic





### Warning

If you switch off the cooling function, the vehicle will not be cooled when weather conditions are warm. The windows can fog up more quickly. Window fogging may impair visibility and endanger you and others.









In automatic mode, the set temperature is maintained automatically at a constant level. The system automatically regulates the temperature of the dispensed air, the airflow and the air distribution.

Automatic mode will achieve optimal operation if cooling with air dehumidification is also activated. If desired, cooling with air dehumidification can be deactivated.





## Controlling the front climate control using the front control panel

- ▶ Turn the SmartKey to position **2** in the ignition lock.
- ▶ Set the desired temperature.
- ▶ **To activate:** press the  button. The indicator lamp in the  button lights up. Automatic air distribution and airflow are activated.
- ▶ **To deactivate:** press the  or  button. The indicator lamp in the  button goes out. Automatic airflow is deactivated and the airflow is controlled according to the level set. Automatic air distribution remains activated.

or



- ▶ Press the , , , , ,  or  button. The indicator lamp in the  button goes out. Automatic air distribution is deactivated. Air distribution is controlled according to the position set. Automatic airflow remains activated.

## Controlling the rear-compartment climate control automatically using the rear control panel

- ▶ Turn the SmartKey to position **2** in the ignition lock.
- ▶ Activate multi-zone automatic climate control using the front control panel.
- ▶ Set the desired temperature.
- ▶ **To activate:** press the  button. The indicator lamp in the  button lights up. Automatic air distribution and airflow are activated.
- ▶ **To deactivate:** press the  or  button. Automatic airflow is deactivated and the airflow is controlled according to the level

set. Automatic air distribution remains activated.



or

- ▶ Press one of the  or  buttons. Automatic air distribution is deactivated. Air distribution is controlled according to the position set. Automatic airflow remains activated.

### Setting the temperature

#### Dual-zone automatic climate control

Different temperatures can be set for the driver's and front-passenger sides.

- ▶ Turn the SmartKey to position **2** in the ignition lock.
- ▶ **To increase/reduce:** turn controls  and  clockwise or counter-clockwise (▷ page 123). Only change the temperature setting in small increments. Start at 72 °F (22 °C).

#### Multi-zone automatic climate control

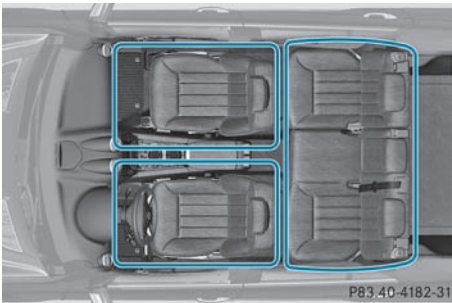



Climate zones of multi-zone automatic climate control



You can select different temperature settings for the driver's and front-passenger sides as well as for the rear compartment.

- ▶ **To increase/reduce the front-compartment temperature using the**





**front control panel:** turn the SmartKey in the ignition lock to position **2**.

- ▶ Turn thumbwheels  and <sup>17</sup>/<sup>18</sup> clockwise or counter-clockwise (▷ page 124). Only change the temperature setting in small increments. Start at 72 °F (22 °C).

For USA only:



- ▶ **To increase/reduce the rear-compartment temperature using the front control panel:** turn the SmartKey in the ignition lock to position **2**.
- ▶ Press the  button.
- ▶ Turn control  clockwise or counter-clockwise (▷ page 124). Only change the temperature setting in small increments. Start at 72 °F (22 °C).

For Canada only:

- ▶ **To increase/reduce the rear-compartment temperature using the front control panel:** turn the SmartKey in the ignition lock to position **2**.
- ▶ Press the  button. The display changes to rear-compartment climate control.
- ▶ Turn control  clockwise or counter-clockwise (▷ page 124). Only change the temperature setting in small increments. Start at 72 °F (22 °C).
-  To return to the standard display, press the  button.

-  The rear display changes to the standard display automatically after three seconds.

- ▶ **To increase/reduce the temperature in the rear compartment using the rear control panel:** turn the SmartKey in the ignition lock to position **2**.

- ▶ Turn thumbwheel <sup>17</sup>/<sup>18</sup> clockwise or counter-clockwise (▷ page 124). Only change the temperature setting in small increments. Start at 72 °F (22 °C).







<sup>17</sup> USA only.

<sup>18</sup> Canada only.









### Setting the air distribution

Multi-zone automatic climate control: you can set the air distribution individually for the driver's and front-passenger sides.<sup>19</sup>



#### Front control unit:

-  directs the airflow through the defroster vents
-  directs the airflow through the defroster vents
-  directs the airflow through the defroster vents
-  directs the airflow through the footwell and side air vents
-  directs the airflow through the footwell and side air vents
-  directs the airflow through the center and side air vents
-  directs the airflow through the center and side air vents

#### Rear control panel:

-  directs the airflow through the rear-compartment air vents
  -  directs the airflow through the footwell air vents
- Turn the key to position **2** in the ignition lock.
- Press the , , , , ,  or  button.

### Setting the airflow

- Turn the SmartKey to position **2** in the ignition lock.
- **To increase/reduce:** press the  or  button.



Vehicles with Voice Control System: when voice control is started, the airflow is restricted to 50%. After voice control is

finished, the airflow is adjusted back to the previous setting.

### Switching the MONO function on/off



Only multi-zone automatic climate control features the "MONO" function.<sup>20</sup>

You can use the MONO function to adopt the settings configured for temperature, air distribution and airflow on the driver's side for the front-passenger side and the rear compartment.



- Press the  button.  
The indicator lamp in the  button lights up or goes out.

### Defrosting the windshield

You can use this function to defrost the windshield or to defrost the inside of the windshield and the side windows.

- i** You should only select the defrosting function until the windshield is clear again.
- Turn the SmartKey to position **2** in the ignition lock.
- **To activate:** press the  button.  
The indicator lamp in the  button lights up.

The climate control system switches to the following functions:

- cooling with air dehumidification on
  - high airflow<sup>21</sup>
  - high temperature<sup>21</sup>
  - air distribution to the windshield and front side windows
  - air-recirculation mode off
- **To deactivate:** press the  button.  
The indicator lamp in the  button goes out. The previously selected settings come into effect again. The cooling with air

<sup>19</sup> Canada only.

<sup>20</sup> Canada only.

<sup>21</sup> Depending on the outside temperature.

dehumidification function remains on. Air-recirculation mode remains deactivated.

or

▶ Press the **OFF** button.

or

▶ Press the **AUTO** button.

or

▶ Turn the temperature control clockwise or counter-clockwise.

or

▶ Press the  or  button.





## Defrosting the windows

### Windows fogged up on the inside

- ▶ Activate the "cooling with air dehumidification" function .
- ▶ Activate automatic mode **AUTO**.
- ▶ If the windows continue to fog up, activate the defrosting function (▷ page 132).

**i** You should only select this setting until the windshield is clear again.

### Windows fogged up on the outside

- ▶ Switch on the windshield wipers.
- ▶ Press the  / <sup>22</sup> or  / <sup>22</sup> air distribution button.

**i** You should only select this setting until the windshield is clear again.

## Rear window heating

### Activating/deactivating

#### **Warning**

Any accumulation of snow and ice should be removed from the rear window before driving. Visibility could otherwise be impaired, endangering you and others.

The rear window heating has a high current draw. You should therefore switch it off as soon as the window is clear as it only switches off automatically after several minutes.

If the battery voltage is too low, the rear window heating may switch off.

▶ Turn the SmartKey to position **2** in the ignition lock.

▶ Press the  button.

The indicator lamp in the  button lights up or goes out.

### Problems with the rear window heating

If the indicator lamp in the  rear window heating button flashes, the on-board voltage is too low or the roof is open. The rear window heating has deactivated itself prematurely or cannot be activated.

- ▶ Switch off any consumers that are not required, e.g. reading lamps or interior lighting.  
When the battery is sufficiently charged, the rear window heating is activated again automatically.

### Activating/deactivating air-recirculation mode



You can deactivate the flow of fresh air if unpleasant odors are entering the vehicle from outside. The air already inside the vehicle will then be recirculated.

The operation of the air-recirculation mode is the same for all control panels.



#### **Warning**

Fogged windows impair visibility, endangering you and others. If the windows begin to fog on the inside, switching off the air recirculation mode immediately should clear interior window fogging. If interior window fogging persists, make sure the air conditioning is activated, or press the  button.

<sup>22</sup> Canada only.

- ▶ Turn the SmartKey to position **2** in the ignition lock.
- ▶ **To activate:** press the  button. The indicator lamp in the  button lights up.

**i** Air-recirculation mode is activated automatically at high outside temperatures. When air-recirculation mode is activated automatically, the indicator lamp in the  button is not lit. Outside air is added after about 30 minutes.

- ▶ **To deactivate:** press the  button. The indicator lamp in the  button goes out.

- i** Air-recirculation mode switches off automatically:
- after approximately five minutes if outside temperatures are under about 41 °F (5 °C)
  - after approximately five minutes if cooling with air dehumidification is deactivated
  - after approximately 30 minutes if outside temperatures are over about 41 °F (5 °C)
- i** The air-recirculation mode does not switch off automatically if outside temperatures exceed 79 °F (26 °C). After about 30 minutes, outside air will be added.<sup>23</sup>

### Switching the residual heat on/off



It is possible to make use of the residual heat of the engine to continue heating the stationary vehicle for up to 30 minutes after the engine has been switched off. The heating time depends on the temperature that has been set.



- i** The blower will run at a low speed regardless of the airflow setting.

<sup>23</sup> Vehicles with multi-zone automatic climate control.

- i** If you activate the "residual heat" function at high temperatures, only the ventilation will be activated. The blower runs at medium speed.

- ▶ Turn the SmartKey to position **0** in the ignition lock or remove it.

- ▶ **To switch on:** press the  button. The indicator lamp in the  button lights up.

- ▶ **To switch off:** press the  button. The indicator lamp in the  button goes out.

- i** Residual heat is deactivated automatically:
- after about 30 minutes
  - when the ignition is switched on
  - if the battery voltage drops
  - if the coolant temperature is too low

## Setting the air vents

### Important safety guidelines

#### Warning

When operating the climate control, the air that enters the passenger compartment through the air vents can be very hot or very cold (depending on the set temperature). This could cause burns or frostbite to unprotected skin in the immediate area of the air vents.

Always keep sufficient distance between unprotected parts of the body and the air vents. If necessary, use the air distribution adjustment to direct the air to air vents in the vehicle interior that are not in the immediate area of unprotected skin.

In order to ensure the direct flow of fresh air through the air vents into the vehicle interior, please observe the following notes:

- keep the air inlet grille on the hood free of blockages, such as ice, snow or leaves
  - never cover the vents or air inlet and outlet grilles in the vehicle interior.
- i** For virtually draft-free ventilation, adjust the sliders of the air vents to the center position.

### Setting the center air vents

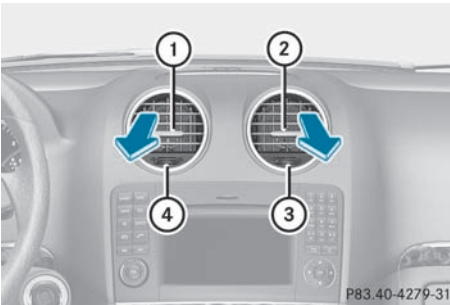

- ① Center air vent, left
- ② Center air vent, right
- ③ Center vent thumbwheel, right
- ④ Center vent thumbwheel, left

► **To open/close:** turn thumbwheels ③ and ④ to the right or left.

### Setting the side air vents

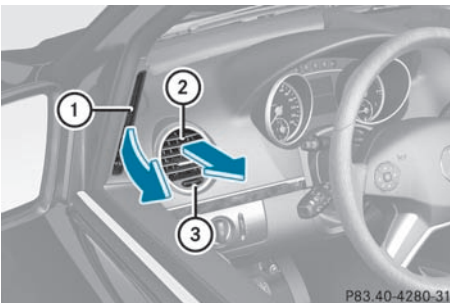

- ① Side air vent, left
- ② Side air vent, right

► **To open/close:** turn thumbwheel ③ to the left or right.

- i** Side window defroster vent ① is never completely shut, even if side air vent ② is shut.

### Setting the rear-compartment air vents

#### Setting the center vents in the rear compartment

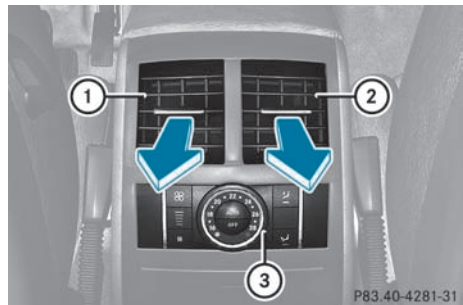

- ① Rear-compartment air vent, left
- ② Rear-compartment air vent, right
- ③ Rear control panel<sup>24</sup>

When the climate control panel is switched on/off, the air supply through the rear-compartment air vents is also switched on/off.

<sup>24</sup> Vehicles with multi-zone automatic climate control.



Vehicle equipment .....	138
Notes on breaking in a new vehicle	138
Driving .....	138
Automatic transmission .....	144
Refueling .....	151
Parking .....	158
Driving tips .....	160
Driving systems .....	171
Off-road driving systems .....	191
Towing a trailer .....	198

## Vehicle equipment

- i** This manual describes all the standard and optional equipment of your vehicle which was available at the time of purchase. Country-specific differences are possible. Note that your vehicle may not be equipped with all functions described.

## Notes on breaking in a new vehicle

### The first 1000 miles (1500 km)

The more you look after the engine when it is new, the happier you will be with its performance in the future.

- Drive at varying vehicle speeds and engine speeds for the first 1000 miles (1500 km) for this reason.
- Avoid overstraining the vehicle during this period, e.g. driving at full throttle.
- Change gear in good time, at the latest when the tachometer needle is  $\frac{2}{3}$  of the way to the red area in the tachometer display.
- Do not manually shift to a lower gear to brake the vehicle.
- If possible, do not depress the accelerator pedal past the point of resistance (kickdown).
- Only select shift ranges **3**, **2** or **1** when driving slowly, e.g. in mountainous terrain.

After 1000 miles (1500 km), you can increase the engine speed gradually and bring the vehicle up to full speed.

Additional breaking-in notes for AMG vehicles:

- do not drive faster than 85 mph (140 km/h) in the first 1000 miles (1500 km).
- only allow the engine to reach a maximum engine speed of 4500 rpm briefly.
- shift gear in good time.
- if possible, drive in drive program **C** for the first 1000 miles (1500 km).

- i** Also, observe these breaking-in notes when the vehicle's engine, front-axle transmission or differential have been replaced.

- i** Always observe the respective speed restrictions.

## Driving

### Important safety guidelines

#### Warning

Make sure absolutely no objects are obstructing the pedals' range of movement. Keep the driver's footwell clear of all obstacles. If there are any floor mats or carpets in the footwell, make sure the pedals still have sufficient clearance.

During sudden driving or braking maneuvers the objects could get caught between the pedals. You could then no longer brake or accelerate. This could lead to accidents and injury.

#### Warning

On slippery road surfaces, never downshift in order to obtain braking action. This could result in drive wheel slip and reduced vehicle control. Your vehicle's ABS will not prevent this type of loss of control.

#### Warning

It is dangerous to shift the automatic transmission out of parking position **P** or neutral position **N** if the engine speed is higher than idle speed. If your foot is not firmly on the brake pedal, the vehicle could accelerate quickly forward or in reverse. You could lose control of the vehicle and hit someone or something. Only shift into gear when the engine is idling normally and when your right foot is firmly on the brake pedal.

#### Warning!

HYBRID vehicles: It is imperative that you read the HYBRID Supplemental Operating

Instructions included in your vehicle literature portfolio. You may otherwise not receive all necessary safety information and warning for the operation of your vehicle.

**!** Warm up the engine quickly. Do not use the engine's full performance until it has reached operating temperature.

Only shift the automatic transmission to the desired drive position when the vehicle is stationary.

Where possible, avoid spinning the drive wheels when pulling away on slippery roads. You could otherwise damage the drive train.

**!** AMG vehicles: at low engine oil temperatures (below 68 °F (+20 °C), the maximum engine speed is restricted in order to protect the engine. To protect the engine and maintain smooth engine operation, avoid driving at full throttle when the engine is cold.

## SmartKey positions

### SmartKey

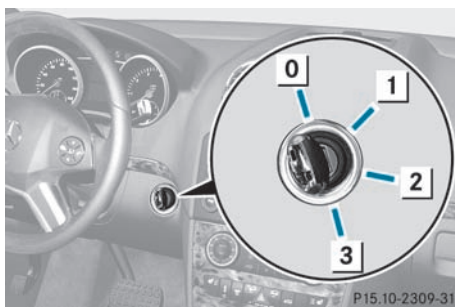

- 0** To remove the SmartKey
- 1** Power supply for some consumers, such as the windshield wipers
- 2** Ignition (power supply for all consumers) and drive position
- 3** To start the engine

As soon as the ignition is switched on, all the indicator lamps in the instrument cluster light

up. The indicator lamps of the low-beam headlamps, high-beam headlamps or the turn signal lamps only light up if the low-beam headlamps, high-beam headlamps or turn signal lamps are switched on. If an indicator lamp does not light up when the ignition is switched on, check it and replace it if necessary. If an indicator lamp does not go out after the engine is started or if it lights up while the vehicle is in motion, see (▷ page 247).

► Remove the SmartKey when the engine is switched off.

The battery may otherwise discharge.

If you cannot turn the SmartKey in the ignition lock, the vehicle battery may not be charged sufficiently.

► Check the vehicle battery and charge if necessary (▷ page 314).

or

► Jump-start the vehicle (▷ page 315).

**i** The SmartKey can be turned in the ignition lock even if it is not the correct SmartKey for the vehicle. The ignition is not switched on. The engine cannot be started.

## KEYLESS-GO

Vehicles with KEYLESS-GO are equipped with a SmartKey with an integrated KEYLESS-GO function and a detachable Start/Stop button. The Start/Stop button must be inserted in the ignition lock and the SmartKey must be in the vehicle.

Pressing the Start/Stop button several times in succession corresponds to the different key positions in the ignition lock. This is only the case if you are not depressing the brake pedal.

If you depress the brake pedal and press the Start/Stop button, the engine starts immediately.

The Start/Stop button can be removed from the ignition lock. Then you can insert the SmartKey in the ignition lock.

- i** You do not have to remove the Start/Stop button from the ignition lock when you leave the vehicle. However, you should always take the SmartKey with you when leaving the vehicle. The vehicle can be started with the Start/Stop button and the electrical equipment can be operated while the SmartKey is in the vehicle.

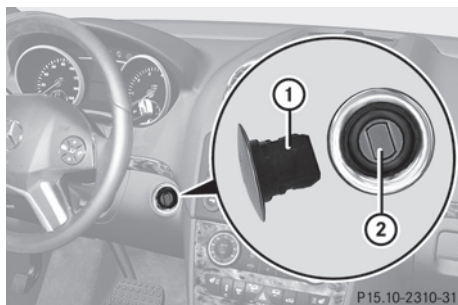

① Start/Stop button

② Ignition lock

- ▶ Insert Start/Stop button ① into ignition lock ②.

- i** When you insert Start/Stop button ① into ignition lock ②, the system requires a detection time of two seconds before you can use Start/Stop button ①.

- ▶ Shift the transmission to position **P**.
- ▶ Do not press the brake pedal.



Start/Stop button

③ USA only

④ Canada only

- ▶ Position **0**: if Start/Stop button ① has not yet been pressed, this corresponds to the SmartKey being removed from the ignition.
- ▶ Position **1**: press Start/Stop button ①. You can now activate the windshield wipers, for example.

- i** If you then open the driver's door when in this position, the power supply is deactivated.

- ▶ Position **2** (ignition): press Start/Stop button ① twice.

- i** If you press Start/Stop button ① once when in this position and the driver's door is open, the power supply is deactivated again.

As soon as the ignition is switched on, all the indicator lights in the instrument cluster light up. The indicator lamps of the low-beam headlamps, high-beam headlamps or the turn signal lamps only light up if the low-beam headlamps, high-beam headlamps or turn signal lamps are switched on. If an indicator lamp does not light up when the ignition is switched on, check it and replace it if necessary. If an indicator lamp does not go out after the engine is started or if it lights up while the vehicle is in motion, see (▷ page 247).

## Starting the engine

### Important safety instructions

#### Warning

Inhalation of exhaust gas is hazardous to your health. All exhaust gas contains carbon monoxide (CO), and inhaling it can cause unconsciousness and possible death.

Do not run the engine in confined areas (such as a garage) which are not properly ventilated. If you think that exhaust gas fumes are entering the vehicle while driving, have the cause determined and corrected immediately. If you must drive under these



conditions, drive only with at least one window fully open at all times.

- ❗ Do not depress the accelerator pedal when starting the engine.

### Automatic transmission

- ▶ Shift the transmission to position **P**.
- ❗ The transmission position display in the multifunction display shows **P**.

### Starting procedure with the SmartKey

- ▶ **To start a gasoline engine:** turn the SmartKey to position **3** in the ignition lock (▷ page 139) and release it as soon as the engine is running.
- ▶ **To start a diesel engine:** turn the SmartKey to position **2** in the ignition lock (▷ page 139).  
The  preglow indicator lamp in the instrument cluster lights up.
- ▶ When the  preglow indicator lamp goes out, turn the SmartKey to position **3** (▷ page 139) and release it as soon as the engine is running.
- ❗ You can start the engine without preglow if the engine is warm.

### Using KEYLESS-GO to start the engine

#### **Warning!**

As long as the SmartKey is in your vehicle, the vehicle can be started. Therefore, never leave children unattended in the vehicle, as they could otherwise accidentally start the engine.

When leaving the vehicle, always take the SmartKey with you and lock the vehicle. Do not leave children unattended in the vehicle, or with access to an unlocked vehicle. A child's unsupervised access to a vehicle could result in an accident and/or serious personal injury.

- ❗ The Start/Stop button can be used to start the vehicle without inserting the SmartKey in the ignition lock. The SmartKey must be in the vehicle.
- ▶ The Start/Stop button must be inserted in the ignition lock.
- ❗ To start the engine with the SmartKey instead of with KEYLESS-GO, remove the Start/Stop button from the ignition lock.
- ▶ Depress the brake pedal and keep it depressed.
- ▶ **To start a gasoline engine:** press the Start/Stop button (▷ page 139) once. The engine starts.
- ▶ **To start a diesel engine:** press the Start/Stop button (▷ page 139) once. Preglow is activated and the engine starts.
- ❗ If the engine is warm, the preglow time is shortened.

### Pulling away

#### Automatic transmission

##### **Warning**

It is dangerous to shift the automatic transmission out of parking position **P** or neutral position **N** if the engine speed is higher than idle speed. If your foot is not firmly on the brake pedal, the vehicle could accelerate quickly forward or in reverse. You could lose control of the vehicle and hit someone or something. Only shift into gear when the engine is idling normally and when your right foot is firmly on the brake pedal.

- ❗ It is only possible to shift the transmission from position **P** to the desired position if you depress the brake pedal. Only then is the parking lock released. If you do not depress the brake pedal, you can move the DIRECT SELECT selector lever but the parking lock remains engaged.

- ▶ Depress the brake pedal and keep it depressed.
  - ▶ Shift the transmission to position **D** or **R**.
  - ▶ Wait until the gear change is completed before pulling away.
  - ▶ Release the parking brake (▷ page 159).
  - ▶ Release the brake pedal.
  - ▶ Carefully depress the accelerator pedal.
- !** If a warning tone sounds and the Release Park. Brake message appears in the instrument cluster, the parking brake is still applied. Release the parking brake.
- i** The vehicle locks centrally once you have pulled away. The locking knobs in the doors drop down.  
You can open the doors from the inside at any time.  
You can also deactivate the automatic locking feature (▷ page 217).
- i** Upshifts take place at higher engine speeds after a cold start. This helps the catalytic converter to reach its operating temperature more quickly.

### Hill start assist

Hill start assist helps you when pulling away forwards or in reverse on an uphill gradient. It holds the vehicle for a short time after you have removed your foot from the brake pedal. This gives you enough time to move your foot from the brake pedal to the accelerator pedal and depress it before the vehicle begins to roll.

#### Warning

Never leave the vehicle when it is held by hill start assist. After approximately one second, hill start assist will no longer brake your vehicle and it could roll away.

- ▶ Take your foot off the brake pedal.
- i** Once you have taken your foot off the brake pedal, the vehicle is held for around one second.
- ▶ Pull away.

Hill start assist will not function if:

- you are pulling away on a level road or a downhill gradient.
- the transmission is in position **N**.
- the parking brake is applied.
- ESP<sup>®</sup> is malfunctioning.

Problems with the engine	
Problem	Possible causes/consequences and ► Solutions
The engine does not start. The starter motor can be heard.	<ul style="list-style-type: none"> <li>• There is a malfunction in the engine electronics.</li> <li>• There is a malfunction in the fuel supply.</li> </ul> <ul style="list-style-type: none"> <li>► Turn the SmartKey back to position <b>0</b> in the ignition lock before the next attempt to start with the SmartKey.</li> <li>► Before the next starting attempt with KEYLESS-GO: shut all open vehicle doors so that the signals from the SmartKey may be better received.</li> </ul> <p>or</p> <ul style="list-style-type: none"> <li>► Pull the Start/Stop button out of the ignition.</li> <li>► Use the SmartKey to start the engine, (► page 141) as external radio signals cause KEYLESS-GO to malfunction. Avoid excessively long and frequent attempts to start the engine as these will drain the battery.</li> </ul> <p>If the engine does not start after several attempts:</p> <ul style="list-style-type: none"> <li>► Consult a qualified specialist workshop.</li> </ul>
The engine does not start. You cannot hear the starter motor.	<p>The on-board voltage is too low because the starter battery is too weak or discharged.</p> <ul style="list-style-type: none"> <li>► Jump-start the vehicle (► page 315).</li> </ul> <p>If the engine does not start despite attempts to jump-start it:</p> <ul style="list-style-type: none"> <li>► Consult a qualified specialist workshop.</li> </ul> <p>The starter motor was exposed to a thermal load that was too high.</p> <ul style="list-style-type: none"> <li>► Allow the starter motor to cool down for approximately two minutes.</li> <li>► Try to start the engine again.</li> </ul> <p>If the engine still does not start:</p> <ul style="list-style-type: none"> <li>► Consult a qualified specialist workshop.</li> </ul>

Problem	Possible causes/consequences and ► Solutions
Vehicles with a gasoline engine: The engine is not running smoothly and is misfiring.	There is a malfunction in the engine electronics or a mechanical component of the engine management system. ► Only depress the accelerator pedal slightly. ► Have the cause rectified immediately at a qualified specialist workshop. Otherwise, non-combusted fuel may get into the catalytic converter and damage it.
The coolant temperature gauge shows a value above 248 °F(120 °C).	The coolant level is too low. The coolant is too hot and the engine is no longer being cooled sufficiently. ► Stop as soon as possible and allow the engine and the coolant to cool down. ► Check the coolant level (> page 285). Observe the warning notes as you do so and add coolant if necessary.

## Automatic transmission

### Important safety guidelines

#### ⚠ Warning

It is dangerous to shift the automatic transmission out of parking position **P** or neutral position **N** if the engine speed is higher than idle speed. If your foot is not firmly on the brake pedal, the vehicle could accelerate quickly forward or in reverse. You could lose control of the vehicle and hit someone or something. Only shift into gear when the engine is idling normally and when your right foot is firmly on the brake pedal.

#### ⚠ Warning!

Keep in mind that turning off the engine alone only will shift the automatic transmission into neutral position **N** automatically.

Always shift the automatic transmission into park position **P** before turning off the engine. Otherwise the vehicle could roll away which could result in an accident and/or serious personal injury.

#### ⚠ Warning!

HYBRID vehicles: It is imperative that you read the HYBRID Supplemental Operating Instructions included in your vehicle literature portfolio. You may otherwise not receive all necessary safety information and warning for the operation of your vehicle.

### DIRECT SELECT lever

#### Overview of transmission positions

The DIRECT SELECT lever is on the right of the steering column.

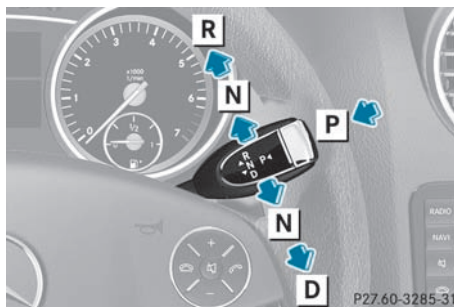

P Park position with parking lock

R Reverse

P27.60-3285-31

- N Neutral
- D Drive

**i** The DIRECT SELECT lever always returns to its original position. The current transmission position **P**, **R**, **N** or **D** appears in the transmission position display (▷ page 145) in the multifunction display.

### Engaging park position P

▶ Push the DIRECT SELECT lever in the direction of the arrow **P**.

**i** Vehicles with a production date as of 18 January 2010: if you open the driver's door when the vehicle is stationary or if the speed is very low, the automatic transmission shifts to park position **P** automatically.

**!** If the engine speed is too high or the vehicle is moving, do not shift the automatic transmission directly from **D** to **R**, from **R** to **D** or directly to **P**. The automatic transmission could otherwise be damaged.

### Engaging reverse gear R

**!** Only shift the automatic transmission to **R** when the vehicle is stationary.

▶ Push the DIRECT SELECT lever up past the first point of resistance.

### Shifting to neutral N

- ▶ When the vehicle is stationary, depress the brake pedal.
- ▶ Push the DIRECT SELECT lever up or down to the first point of resistance.

When the engine is switched off, the automatic transmission shifts to **N** automatically.

### Remaining in neutral N

If you wish to keep the automatic transmission in neutral **N**, e.g. to wash the

vehicle in a car wash with a towing device, observe the following:

#### Using the SmartKey:

- make sure the ignition is switched on.
- when the vehicle is stationary, depress the brake pedal and keep it depressed.
- shift to neutral **N**.
- release the brake pedal.
- if applied, release the parking brake.
- switch off the ignition and leave the SmartKey in the ignition lock.

#### Using KEYLESS-GO:

- make sure the ignition is switched on.
- when the vehicle is stationary, depress the brake pedal and keep it depressed.
- shift to park position **P**.
- release the brake pedal.
- remove the Start/Stop button from the ignition lock.
- insert the SmartKey into the ignition lock.
- switch on the ignition.
- depress the brake pedal and keep it depressed.
- shift to neutral **N**.
- release the brake pedal.
- if applied, release the parking brake.
- switch off the ignition and leave the SmartKey in the ignition lock.

### Shifting to transmission position D

▶ Push the DIRECT SELECT lever down past the first point of resistance.

#### Transmission position display

The current transmission position is shown in the multifunction display.

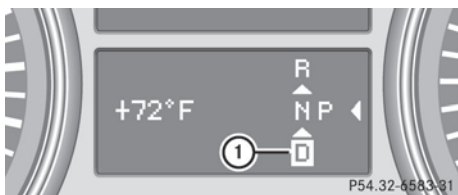

① Transmission position

**i** The arrows in the transmission position display show how and into which transmission positions you can change using the DIRECT SELECT lever.

**!** If the transmission position display in the multifunction display is not working, you should pull away carefully to check whether the desired transmission position is engaged. Ideally, you should select transmission position **D** and drive program **S**. On AMG vehicles, select drive program **C**. Do not restrict the shift range.

### Transmission positions

#### **P** Park position

Do not shift the transmission into position **P** unless the vehicle is stationary. The parking lock should not be used as a brake when parking. In addition to engaging the parking lock, you must always apply the parking brake to secure the vehicle.

In the event of a fault in the vehicle electronics, the transmission can be locked in position **P**.

Have the vehicle electronics checked immediately at a qualified specialist workshop, e.g. an authorized Mercedes-Benz Center.

#### **R** Reverse

Only shift the transmission to **R** when the vehicle is stationary.

#### **N** Neutral

Do not shift the transmission to **N** while driving. The transmission could otherwise be damaged.

No power is transmitted from the engine to the drive wheels.

Releasing the brakes will allow you to move the vehicle freely, e.g. to push it or tow it.

If ESP<sup>®</sup> is deactivated or faulty: only shift the transmission to position **N** if the vehicle is in danger of skidding, e.g. on icy roads.

**!** Driving in neutral **N** can damage the drive train.

#### **D** Drive

The automatic transmission changes gear automatically. All forward gears are available.

### Gearshifting

The automatic transmission shifts to the individual gears automatically when it is in transmission position **D**. This automatic gearshifting behavior is determined by:

- a shift range restriction, if selected
- the selected drive program
  - **C/S** or **M** (AMG vehicles) (▷ page 147)
- the position of the accelerator pedal
- the road speed

## Driving tips

### Kickdown

Use kickdown for maximum acceleration.

- ▶ **Vehicles for USA except AMG vehicles:** fully depress the accelerator pedal. The transmission shifts to a lower gear depending on the engine speed.
- ▶ **Vehicles for Canada except AMG vehicles:** depress the accelerator pedal beyond the pressure point. The transmission shifts to a lower gear depending on the engine speed.

### Rocking the vehicle free

Rocking the vehicle free by repeatedly shifting back and forth between transmission positions **D** and **R** can help to free a vehicle that has become stuck in mud or snow. The engine management system of the vehicle limits shifting back and forth between transmission positions **D** and **R** to a maximum speed of 5 mph (9 km/h). To shift back and forth between transmission positions **D** and **R**, move the selector lever up and down beyond the pressure point.

### Working on the vehicle

#### Warning

When working on the vehicle, engage the parking brake and shift the automatic transmission into park position **P**. Otherwise the vehicle could roll away which could result in an accident and/or serious personal injury.

### Trailer towing

- ▶ When towing a trailer and driving downhill, shift to a lower gear if the automatic transmission constantly shifts between two gears.
- ▶ Engaging a lower gear and reducing the speed reduces the risk of the engine overheating.

## Program selector button

The program selector button is only available for AMG vehicles.





Program selector button with manual drive program (AMG vehicles only)

<b>C</b> Comfort	Comfortable, economical driving
<b>S</b> Sport	Sporty driving style
<b>M</b> Manual	Manual gearshifting

-  For further information on "Drive program" (▷ page 148).

Only change from automatic drive program **C** or **S** to manual drive program **M** when the vehicle is stationary.

- ▶ Press program selector button  repeatedly until the letter for the desired gearshift program appears in the multifunction display.
-  The automatic transmission switches to automatic drive program **C** each time the engine is started.

## Steering wheel paddle shifters



- ① Left-hand steering wheel paddle shifter  
 ② Right-hand steering wheel paddle shifter

You can restrict or derestrict the shift range by using the steering wheel paddle shifter. You can change gear yourself by using the steering wheel paddle shifters in the manual drive program.

## Automatic drive program

Drive program **C** is characterized by the following:

- the vehicle pulling away more gently in forward and reverse gears, unless the accelerator pedal is depressed fully
- increased sensitivity; this improves driving stability on slippery road surfaces, for example.
- the automatic transmission shifting up sooner, which results in the vehicle being driven at lower engine speeds and the wheels being less likely to spin

In drive program **S**, the automatic transmission shifts up later.

## Shift ranges

### Introduction

When the automatic transmission is in position **D**, it is possible to restrict or derestrict the shift range (▷ page 148).

The shift range selected is shown in the multifunction display. The automatic transmission shifts only as far as the selected gear.

### Driving situations

- |          |   |
|----------|---|
| <b>3</b> | You can use the engine's braking effect.  |
| <b>2</b> | To use the braking effect of the engine on downhill gradients and for driving: <ul style="list-style-type: none"> <li>• on steep mountain roads</li> <li>• in mountainous terrain</li> <li>• in arduous conditions</li> </ul> |
| <b>1</b> | To use the braking effect of the engine on extremely steep downhill gradients and on long downhill stretches  |

## Restricting the shift range

- Pull the left-hand steering wheel paddle shifter.  
 The shift range is restricted.

- i** In order to prevent the engine from overrevving, the automatic transmission does not shift down when the engine speed is too high.
- i** If the maximum engine speed for the shift range is reached and you continue to accelerate, the automatic transmission shifts up in order to prevent the engine from overrevving, even if the shift range is restricted.

## Derestricting the shift range

- Pull the right-hand steering wheel paddle shifter.  
 The shift range is derestricted.

## Clearing the shift range restriction

- ▶ Pull and hold the right-hand steering wheel paddle shifter until **D** is shown again in the multifunction display.

The automatic transmission shifts from the current shift range directly to **D**.

## Selecting the ideal shift range

- ▶ Pull the left-hand steering wheel paddle shifter and hold it in position.

The automatic transmission shifts to the gear which allows ideal acceleration and deceleration. To do this, the automatic transmission shifts down one or more gears.

## Manual drive program

### Switching on the manual drive program

The manual drive program is only available for AMG vehicles.

Manual drive program **M** is different from drive program **S** with regard to spontaneity, responsiveness and smoothness of gear changes.

Manual drive program **M** can be selected using the program selector button. You can change gear using the steering wheel paddle shifters in manual drive program **M** if the transmission is in position **D**. The gear currently selected and engaged is shown in the multifunction display.

- ▶ Press program selector button (▷ page 147) repeatedly until **M** appears in the multifunction display.

### Upshifting

- ▶ Pull the right-hand steering wheel paddle shifter (▷ page 148).

The automatic transmission shifts up to the next gear.

- ! In manual drive program **M**, the automatic transmission does not shift up

automatically even when the engine limiting speed for the current gear is reached. When the engine limiting speed is reached, the fuel supply is cut to prevent the engine from overrevving. Always make sure that the engine speed does not reach the red area of the tachometer. There is otherwise a risk of engine damage.

Before the engine speed reaches the red area, you will see an upshift indicator in the multifunction display.

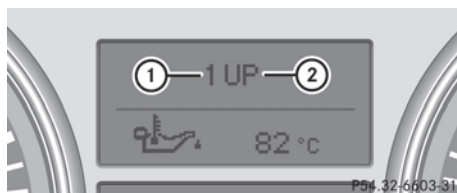

- ① Gear indicator
- ② Upshift indicator

- ▶ Pull the right-hand steering wheel paddle shifter.  
The automatic transmission shifts up to the next gear.

### Downshifting

- ▶ Pull the left-hand steering wheel paddle shifter (▷ page 148).  
The automatic transmission shifts down to the next gear.

- i If you brake the vehicle or stop without shifting down, the automatic transmission will shift down to a gear that will allow the vehicle to accelerate or pull away again.
- i For maximum acceleration, pull the left-hand steering wheel paddle shifter until the transmission selects the optimum gear for the current speed.

### Kickdown

- i Kickdown is not possible in manual drive program **M**.

### **Switching off the manual drive program**

- ▶ **AMG vehicles:** press the program selector button (▷ page 147) repeatedly until **C** or **S** appears in the multifunction display.

## Problems with the transmission

Problem	Possible causes/consequences and ► Solutions
<p>The acceleration ability is deteriorating.</p> <p>The transmission no longer changes gear.</p>	<p>The transmission is in emergency mode.</p> <p>It is only possible to shift into <b>2nd</b> gear and reverse gear.</p> <ul style="list-style-type: none"> <li>► Stop the vehicle.</li> <li>► Shift the transmission to position <b>P</b>.</li> <li>► Switch off the engine.</li> <li>► Wait at least 10 seconds before restarting the engine.</li> <li>► Shift the transmission to position <b>D</b> or <b>R</b>. If <b>D</b> is selected, the transmission shifts into <b>2nd</b> gear; if <b>R</b> is selected, the transmission shifts into reverse gear.</li> <li>► Have the transmission checked at a qualified specialist workshop immediately.</li> </ul>

## Transfer case

This section is only valid for vehicles with 4-wheel drive (4MATIC). Power is always transmitted to both axles.

**!** Performance tests may only be carried out on a 2-axle dynamometer. The brake system or transfer case could otherwise be damaged. Contact an authorized Mercedes-Benz Center for a performance test. Mercedes-Benz recommends that you use an authorized Mercedes-Benz Center for this purpose.

**!** If the parking brake is being tested on a brake dynamometer, the ignition must be switched off (SmartKey or Start/Stop button in position **0** or **1**), as ESP<sup>®</sup> will otherwise automatically intervene. The test must last a maximum of 10 seconds. The brake system could otherwise be damaged.

## Refueling

### Important safety guidelines

#### Warning!

Gasoline and diesel fuels are highly flammable and poisonous. They burn violently and can cause serious injury.

Never allow sparks, flames or smoking materials near gasoline or diesel fuel!

Turn off the engine before refueling.

Whenever you are around gasoline or diesel fuel, avoid inhaling fumes and any skin or clothing contact. Extinguish all smoking materials.

Direct skin contact with fuels and the inhalation of fuel vapors are damaging your health.

#### Warning

Overfilling of the fuel tank may create pressure in the system which could cause a gas discharge. This could cause the gasoline to spray back out when removing the fuel pump nozzle, which could cause personal injury.

**⚠ Warning!**

HYBRID vehicles: It is imperative that you read the HYBRID Supplemental Operating Instructions included in your vehicle literature portfolio. You may otherwise not receive all necessary safety information and warning for the operation of your vehicle.

**⚠ Warning!**

Do not fill diesel tanks with gasoline. Do not mix diesel fuel with gasoline. Otherwise the fuel system and engine could be damaged. In addition, the vehicle could catch fire.

**!** Do not use gasoline to refuel vehicles with a diesel engine. Do not use diesel to refuel vehicles with a gasoline engine. Even small amounts of the wrong fuel result in damage to the fuel system and engine.

**!** Do not start the engine if you accidentally refuel with the wrong fuel. Otherwise, the fuel could enter the fuel lines. This would require draining of the fuel tank and fuel lines. Notify a qualified specialist workshop and have the fuel tank and fuel lines drained completely.

**Gasoline****Fuel grade**

**!** You should only refuel with unleaded premium-grade gasoline as this avoids damaging the catalytic converter.

If engine running problems are apparent, have the cause checked immediately and repaired. Excess unburned fuel can otherwise enter the catalytic converter, leading to overheating and possibly causing a fire.

**i** Only refuel with unleaded premium-grade gasoline with a specified minimum octane number of 91 (average value of 96 RON/ 86 MON).

Usually you will find information about the fuel grade on the pump. If you cannot find

the label on the gasoline pump, ask the gas station staff.

You can find further information under "Fuel" (▷ page 358), by consulting an authorized Mercedes-Benz Center or visiting <http://www.mbusa.com> (USA only).

**Diesel****Fuel grade**

**!** Only refuel with ULTRA-LOW SULFUR DIESEL FUEL (ULSD, 15 ppm SULFUR MAXIMUM). Using other diesel fuels could result in increased wear and damage to the engine and/or exhaust system.

Never refuel with marine diesel or heating oil.

Do not mix these fuels with diesel fuels and do not use any special additives, as this may result in damage.

**!** When refueling using a fuel can, use a filter or use a clean cloth as a filter. Otherwise, particles from the fuel can may block the fuel lines and/or the diesel injection system.

**i** Refuel only with ULTRA-LOW SULFUR DIESEL FUEL (ULSD, 15 ppm SULFUR MAXIMUM).

Usually you will find information about the fuel grade on the pump. If you cannot find the label on the gasoline pump, ask the gas station staff.

You can find further information under "Fuel" (▷ page 358), by consulting an authorized Mercedes-Benz Center or by visiting <http://www.mbusa.com> (USA only).

**Low outside temperatures**

**!** Do not use gasoline to refuel vehicles with a diesel engine. Never mix diesel with gasoline or kerosene, as this may result in damage to the engine or fuel system.

Diesel fuel with improved cold flow properties is available during the winter months. Further information on fuel properties can be obtained from oil companies, e.g. at filling stations.

## Refueling

### Fuel filler flap

The fuel filler flap is unlocked or locked automatically when you open or close the vehicle with the SmartKey or using KEYLESS-GO.

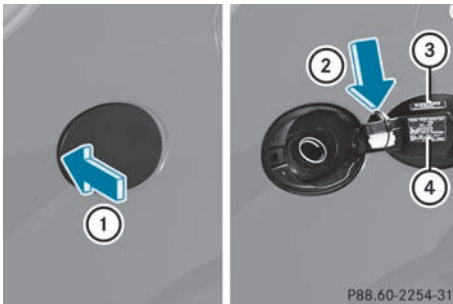

The position of the fuel filler flap is to the rear on the right. The position of the fuel filler cap is displayed in the instrument cluster . The arrow next to the filling pump indicates the side of the vehicle.



- ① To open the fuel filler flap
- ② To insert the fuel filler cap
- ③ Fuel type
- ④ Tire pressure table

### Opening

- ▶ Switch off the engine.

**i** When the engine is running and the fuel filler flap is open, the yellow reserve fuel warning lamp and the  (USA only) or  (Canada only) engine diagnostics warning lamp may light up.

For further information on warning and indicator lamps in the instrument cluster, see (▶ page 252).

- ▶ Remove the SmartKey from the ignition lock.  
KEYLESS-GO: the driver's door is open. This returns the ignition to position **0**, which corresponds to the SmartKey being removed. The driver's door can be closed again.
- ▶ Press the fuel filler flap in the direction of arrow ①.  
The fuel filler flap opens slightly.
- ▶ Open the fuel filler flap.
- ▶ Turn the fuel filler cap counter-clockwise and remove it.
- ▶ Insert the fuel filler cap into the holder bracket on the inside of filler flap ②.
- ▶ Completely insert the filler neck of the fuel pump nozzle into the tank and refuel.
- ▶ Only fill the tank until the pump nozzle switches off.

**!** Overfilling the fuel tank could damage the fuel system.

### Closing

- ▶ Replace the fuel filler cap and turn it clockwise. The fuel filler cap audibly engages.
- i** Close the fuel filler flap before locking the vehicle. A locking pin otherwise prevents the fuel filler flap from closing after the vehicle has been locked.
- ▶ Close the fuel filler flap.

### Emergency fuel filler flap release

#### **Warning!**

HYBRID vehicles: It is imperative that you read the HYBRID Supplemental Operating Instructions included in your vehicle literature portfolio. You may otherwise not receive all necessary safety information and warning for the operation of your vehicle.

**⚠ Warning!**

Avoid contact with the vehicle walls as they may contain sharp edges. Otherwise, you could injure yourself while releasing the fuel filler flap.

The emergency release is located behind the side trim panel in the cargo compartment.

- ▶ Open the tailgate.
- ▶ Open the right-hand side trim panel (▷ page 114).

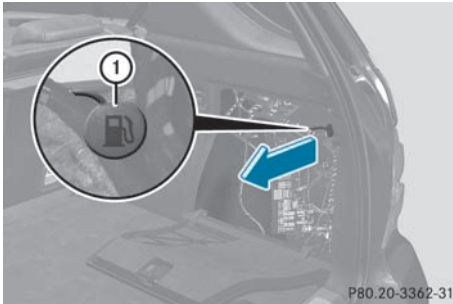

- ▶ Pull emergency release ① in the direction of the arrow.  
The fuel filler flap is unlocked.
- ▶ Open the fuel filler flap.

Problems with the fuel and fuel tank	
Problem	Possible causes/consequences and ► Solutions
Fuel is leaking from the vehicle.	<p> <b>Risk of explosion or fire</b></p> <p>The fuel line or fuel tank is defective.</p> <ul style="list-style-type: none"> <li>► Turn the SmartKey to position <b>0</b>(▷ page 139) in the ignition lock immediately and remove it.</li> <li>► Do not restart the engine under any circumstances.</li> <li>► Consult a qualified specialist workshop.</li> </ul>
The fuel filler flap cannot be opened.	<p>The fuel filler flap is not released.</p> <p>or</p> <p>The SmartKey batteries are discharged.</p> <ul style="list-style-type: none"> <li>► Unlock the vehicle using the mechanical key (▷ page 75).</li> <li>► Open the tailgate.</li> <li>► Manually unlock the fuel filler flap using the emergency release (▷ page 153).</li> </ul>
	<p>The fuel filler flap is released, but the opening mechanism is jammed.</p> <ul style="list-style-type: none"> <li>► Manually unlock the fuel filler flap using the emergency release (▷ page 153).</li> <li>► Consult a qualified specialist workshop.</li> </ul>
The fuel tank in a diesel engine vehicle has been run completely dry and the engine will not start.	<p>There is air in the fuel system.</p> <ul style="list-style-type: none"> <li>► Refuel the vehicle with at least 5.3 US qt (5 liters) of diesel.</li> <li>► Turn the ignition on for at least 10 seconds. Turn the SmartKey to position <b>2</b>(▷ page 139) in the ignition lock.</li> <li>► Start the engine continuously for up to 10 seconds until it runs smoothly.</li> </ul> <p>If the engine does not start:</p> <ul style="list-style-type: none"> <li>► Turn the ignition on again for approximately 10 seconds. Turn the SmartKey to position <b>2</b>(▷ page 139) in the ignition lock.</li> <li>► Start the engine again continuously for up to 10 seconds until it runs smoothly.</li> </ul> <p>If the engine does not start after three attempts:</p> <ul style="list-style-type: none"> <li>► Consult a qualified specialist workshop.</li> </ul>

## AdBlue®

## Important notes on use

BlueTEC exhaust gas aftertreatment<sup>25</sup> must be operated with AdBlue® reducing agent in order to function properly. Adding AdBlue® is one of the tasks performed during maintenance. Under normal operating conditions, a tank of AdBlue® lasts until the next service due date.

When the AdBlue® supply has almost run out, the Check Additive - See Operator's Manual message is shown in the multifunction display.

When the AdBlue® supply sinks to a minimum level, the Remaining Starts: 20 message is shown in the multifunction display.

**i** When the Remaining Starts: 20 message is shown in the multifunction display, you can start the engine 20 more times. If AdBlue® is not topped up, it is then not possible to start the engine again. Top up the AdBlue® tank with approximately 1 gallon (3.8 l) of AdBlue® or have the AdBlue® tank refilled at a qualified specialist workshop, e.g. an authorized Mercedes-Benz Center.

Use the special AdBlue® refill bottle when adding between maintenance intervals. For more information, please contact an authorized Mercedes-Benz Center or Roadside Assistance if applicable (▷ page 20).

Further information about BlueTEC exhaust gas aftertreatment and AdBlue® is available at any authorized Mercedes-Benz Center.

## Adding AdBlue®

 Warning!

Make sure

- AdBlue® does not come into contact with skin, eyes, or clothing
- to keep AdBlue® out of the reach of children

If you and/or others have come into contact with AdBlue®:

- If AdBlue® has gotten into contact with eyes, flush with plenty of water immediately and seek medical help.
- Clean affected skin immediately with plenty of water.
- If AdBlue® was swallowed, rinse mouth immediately with plenty of water and drink plenty of water. Consult a physician.

 Warning!

When opening the filler cap of the AdBlue® tank ammonia gas vapors may escape. Refill AdBlue® in a well ventilated area only. Ammonia gas vapors have a pungent odor and are particularly irritating for your skin, mucous membranes, and eyes. Inhaling ammonia gas vapors will cause burning eyes, nose, and throat, as well as coughing and watering eyes.

**!** Only use AdBlue® that complies with ISO 2224 1. Do not add any special additives to AdBlue® and do not thin AdBlue® with water. This could destroy the BlueTEC exhaust gas aftertreatment.

**!** Rinse surfaces that have come into contact with AdBlue® immediately with water or remove AdBlue® using a damp cloth and cold water. If the AdBlue® has already crystallized, use a sponge and cold water to clean it. AdBlue® residues crystallize after time and contaminate the affected surfaces.

<sup>25</sup> Only on BlueTEC vehicles.

**!** AdBlue® is not an additive and must not be added to the diesel tank. If AdBlue® is added to the diesel tank this could damage the engine.

**i** If you are adding between maintenance intervals, add approximately 1 gallon (3.8 l) of AdBlue® to the AdBlue® tank. 1 gallon (3.8 l) of AdBlue® is approximately 2 AdBlue® refill bottles.

Further information about AdBlue® (▷ page 360).

The AdBlue® filler neck is under the luggage compartment floor.

- ▶ Switch off the ignition.
- ▶ Open the tailgate.
- ▶ Lift the luggage compartment floor (▷ page 298).

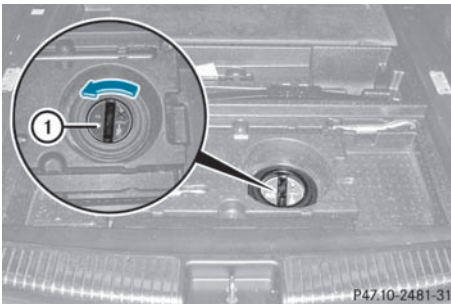

- ▶ Turn AdBlue® cap (1) anti-clockwise and remove it.

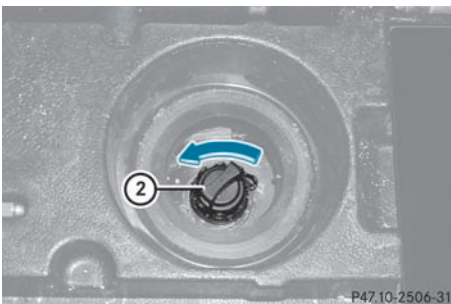

- ▶ Turn AdBlue® filler cap (2) anti-clockwise and open it. Filler cap (2) is secured with a plastic strap.

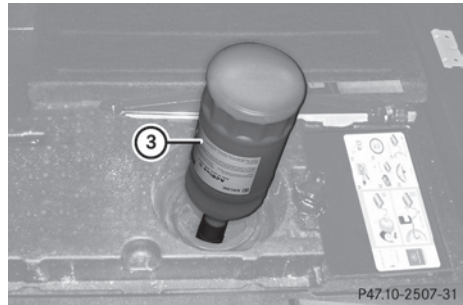

- ▶ Unscrew the covering cap from AdBlue® refill bottle (3).
- ▶ Place AdBlue® refill bottle (3) on the filler neck as shown and screw on clockwise hand-tight.
- !** Only screw on the AdBlue® refill bottle hand-tight. It could otherwise be damaged.
- ▶ Press AdBlue® refill bottle (3) down. The AdBlue® tank is filled. This may take up to one minute.

- i** If the AdBlue® refill bottle is no longer pressed down, the filling process stops and the partially emptied bottle can be removed.
- ▶ Release AdBlue® refill bottle (3).
- ▶ Turn AdBlue® refill bottle (3) anti-clockwise and remove it.
- ▶ Place AdBlue® filler cap (2) on the filler neck and turn it clockwise.

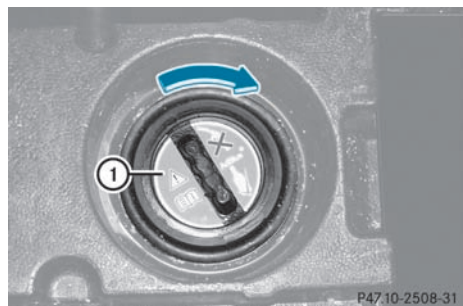

- ▶ Insert AdBlue® cap ① as shown and turn it clockwise as far as it will go.
- ▶ Fold the load compartment floor down.
- ▶ Close the tailgate.
- ▶ Drive at a speed above 10 mph (16 km/h). The Check Additive - See Operator's Manual disappears after approximately one minute.

**i** If the Check Additive - See Operator's Manual is still displayed in the multifunction display, top up with another bottle of AdBlue®.

**i** Then, have the AdBlue® supply checked and filled completely if necessary. Mercedes-Benz recommends that you use a qualified specialist workshop such as an authorized Mercedes-Benz Center for this purpose.

## Parking

### Important safety guidelines

#### Warning!

Do not park this vehicle in areas where combustible materials such as grass, hay or leaves can come into contact with the hot exhaust system. These materials could be ignited and cause a vehicle fire.

Vehicle movement may result in serious personal injury or damage to the vehicle or vehicle drivetrain. Therefore, always do the following before turning off the engine and leaving the vehicle:

- Keep right foot on the brake pedal.
- Engage the parking brake.
- Shift the automatic transmission into park position **P**.
- Slowly release the brake pedal.
- When parked on an incline, always turn the front wheels towards the road curb.
- Turn the SmartKey in the starter switch to position **0** and remove the SmartKey from

the starter switch, or press the KEYLESS-GO start/stop button.

- Take the SmartKey with you and lock the vehicle when leaving.

### Switching off the engine

#### Important safety instructions

#### Warning

Do not turn off the engine before the vehicle has come to a complete stop. With the engine not running, there is no power assistance for the brake and steering systems. In this case, it is important to keep in mind that a considerably higher degree of effort is necessary to brake and steer the vehicle.

- i** If you cannot turn off the engine as described here, see "Emergency engine shut down" (▷ page 322).

#### Vehicles with automatic transmission

#### Warning!

Keep in mind that turning off the engine alone only will shift the automatic transmission into neutral position **N** automatically.

Always shift the automatic transmission into park position **P** before turning off the engine. Otherwise the vehicle could roll away which could result in an accident and/or serious personal injury.

- ▶ Shift the transmission to position **P**.

#### Using the SmartKey

- ▶ Turn the SmartKey to position **0** in the ignition lock and remove it. The immobilizer is activated.
- ▶ Apply the parking brake firmly.

**i** If you turn off the engine with the SmartKey and then remove it from the ignition lock or open a front door, the automatic transmission switches to **P** automatically.

**Using KEYLESS-GO**

- ▶ Press the Start/Stop button (▷ page 139). When the driver's door is closed, the Start/Stop button is in position **1**. When the driver's door is opened, the Start/Stop button moves to position **0**. This corresponds to removing the SmartKey.
- ▶ Apply the parking brake firmly.
- i** If you turn off the engine with the Start/Stop button and open a front door, the automatic transmission switches to **P** automatically.
- i** The engine can be turned off while the vehicle is in motion by pressing and holding the Start/Stop button for three seconds.

If you have started the engine with the Start/Stop button and it cannot be switched off as described:

- ▶ remove the Start/Stop button from the ignition lock.
- ▶ insert the SmartKey into the ignition lock. The engine stops. The ignition lock is in position **0**.

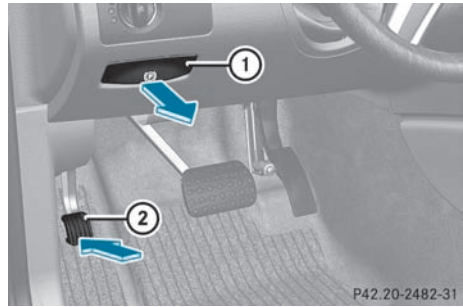

- ▶ **To apply:** depress parking brake **2** firmly. When the engine is running, the **BRAKE** (USA only) or **(P)** (Canada only) indicator lamp lights up in the instrument cluster.
- ▶ **To release:** depress the brake pedal and keep it depressed.
- ▶ Pull release handle **1**. When the ignition is switched on or the engine is running, the **BRAKE** (USA only) or **(P)** (Canada only) indicator lamp goes out in the instrument cluster.

**Parking brake**

**Warning**

Engaging the parking brake while the vehicle is in motion can cause the rear wheels to lock up. You could lose control of the vehicle and cause an accident. In addition, the vehicle's brake lights do not light up when the parking brake is engaged.

**Warning!**

When leaving the vehicle, always remove the SmartKey from the starter switch, take it with you, and lock the vehicle. Do not leave children unattended in the vehicle, or with access to an unlocked vehicle. Children could release the parking brake and/or shift the automatic transmission out of park position **P**, either of which could result in an accident and/or serious personal injury.

**Parking up the vehicle**

If you leave the vehicle parked up for longer than four weeks, the battery may be damaged by exhaustive discharge.

- ▶ Disconnect the battery or connect it to a trickle charger.
- i** You can obtain information about trickle chargers from a qualified specialist workshop, e.g. an authorized Mercedes-Benz Center.

If you leave the vehicle parked up for longer than six weeks, the vehicle may suffer damage as a result of lack of use.

- ▶ Visit a qualified specialist workshop and seek advice.

## Driving tips

### General driving tips

#### Important safety instructions

##### Warning!

Please do not forget that your primary responsibility is to drive the vehicle. A driver's attention to the road must always be his/her primary focus when driving. For your safety and the safety of others, we recommend that you pull over to a safe location and stop before placing or taking a telephone call.

If you choose to use the telephone<sup>26</sup> while driving, please use the hands-free device and only use the telephone when road, weather and traffic conditions permit. Some jurisdictions prohibit the driver from using a mobile telephone while driving a vehicle.

Only operate the COMAND<sup>26</sup> (Cockpit Management and Data System) if road, weather and traffic conditions permit. Otherwise, you may not be able to observe traffic conditions and could endanger yourself and others.

Bear in mind that at a speed of just 30 mph (approximately 50 km/h), your vehicle is covering a distance of 44 feet (approximately 14 m) every second.

#### Drive sensibly – save fuel

To save fuel, observe the following notes:

- ▶ Keep tires at the recommended inflation pressures.
- ▶ Remove unnecessary cargo.
- ▶ Remove the roof carrier when not in use.
- ▶ Maintain a low engine speed until the engine is warm.
- ▶ Avoid frequent acceleration and deceleration.
- ▶ Have all maintenance work performed at the service intervals specified in the

Service Booklet or indicated by the service interval indicator.

Fuel consumption is also increased by driving in cold weather, in stop-and-go traffic, on short trips and in mountainous areas.

#### Drinking and driving

##### Warning

Drinking and driving and/or taking drugs and driving are very dangerous combinations. Even a small amount of alcohol or drugs can affect your reflexes, perceptions and judgment.

The possibility of a serious or even fatal accident are greatly increased when you drink or take drugs and drive.

Do not drink or take drugs and drive or allow anyone to drive who has been drinking or taking drugs.

#### Pedals

##### Warning

Make sure absolutely no objects are obstructing the pedals' range of movement. Keep the driver's footwell clear of all obstacles. If there are any floor mats or carpets in the footwell, make sure that the pedals still have sufficient clearance.

During sudden driving or braking maneuvers, the objects could get caught between the pedals. You could then no longer brake or accelerate. This could lead to accidents and injury.

#### Coasting with the engine switched off

##### Warning!

There is no power assistance for the steering and the brake when the engine is not running. Steering and braking requires significantly more effort and you could lose control of the vehicle and cause an accident as a result.

<sup>26</sup> Observe all legal requirements.

Do not turn off the engine while the vehicle is in motion.

## Exhaust check

### Warning

Inhalation of exhaust gas is hazardous to your health. All exhaust gas contains carbon monoxide (CO), and inhaling it can cause unconsciousness and possible death.

Do not run the engine in confined areas (such as a garage) which are not properly ventilated. If you think that exhaust gas fumes are entering the vehicle while driving, have the cause determined and corrected immediately. If you must drive under these conditions, drive only with at least one window fully open at all times.

Certain engine systems are designed to keep the level of poisonous components in exhaust fumes within legal limits.

These systems only work optimally if they are maintained exactly in accordance with the manufacturer's specifications. For this reason, all work on the engine must be carried out by qualified and authorized Mercedes-Benz technicians.

The engine settings must not be changed in any circumstances. Furthermore, all specific service work must be carried out at regular intervals and in accordance with the Mercedes-Benz service requirements. Details can be found in the Service Booklet.

## Engine oil

### Vehicles with a diesel particle filter:

If the vehicle is mostly driven for short distances, it is possible that malfunctions may occur during the automatic cleaning of the diesel particle filter. This can lead to engine damage. Therefore, if you frequently drive short distances, make sure to drive on highways or country roads for 20 minutes at least every 500 km.

## Brakes

### Important safety guidelines

#### Warning

On slippery road surfaces, never downshift in order to obtain braking action. This could result in drive wheel slip and reduced vehicle control. Your vehicle's ABS will not prevent this type of loss of control.

#### Warning

Make sure that you do not endanger other road users when you apply the brakes.

### Downhill gradients

 On long and steep gradients, you must reduce the cargo on the brakes by shifting to a lower gear in good time. This allows you to take advantage of engine braking and helps you to avoid overheating the brakes and wearing them out excessively.

When you take advantage of engine braking, a drive wheel may not turn for some time, e.g. on a slippery road surface. This could cause damage to the drive train. Such damage is not covered by the Mercedes-Benz warranty.

### Heavy and light loads

#### Warning

Depressing the brake pedal constantly results in excessive and premature wear to the brake pads.

It may also cause the brakes to overheat, seriously impairing their effectiveness. It may then not be possible to stop the vehicle in sufficient time to avoid an accident.

If the brakes have been subjected to a heavy cargo, do not stop the vehicle immediately, but drive on for a short while. This allows the airflow to cool the brakes more quickly.

## Wet roads

### Warning

After driving in heavy rain for some time without applying the brakes or through water deep enough to wet brake components, the first braking action may be somewhat reduced. You have to depress the brake pedal more firmly. Maintain a safe distance from vehicles in front.

After driving on a wet road or having the vehicle washed, brake firmly while paying attention to the traffic conditions. This will warm up the brake discs, thereby drying them more quickly and protecting them against corrosion.

## Limited braking performance on salt treated roads

### Warning

The layer of salt on the brake discs and the brake pads/linings may cause a delay in the braking effect, resulting in a significantly longer braking distance, which could lead to an accident.

To avoid this danger, you should:

- occasionally brake carefully, without putting other road users at risk, when you are driving on salted roads. This helps to remove any salt that may have started to build up on the brake discs and the brake pads/linings.
- maintain a greater distance to the vehicle ahead and drive with particular care.
- carefully apply the brakes at the end of a trip and immediately after commencing a new trip, so that salt residues are removed from the brake discs.

## Maintenance of the brakes

 If the brake warning lamp lights up in the instrument cluster and you hear a warning tone, even though the parking brake has been released, the brake fluid level may be

too low. Observe additional warning messages in the multifunction display.

The brake fluid level may be too low due to brake pad wear or leaking brake lines.

Have the brake system checked immediately. This work should be carried out at an authorized Mercedes-Benz Center.

All checks and maintenance work on the brake system must be carried out at a qualified specialist workshop. Contact an authorized Mercedes-Benz Center.

Only install brake pads and use brake fluid recommended by Mercedes-Benz.

### Warning

If other than recommended brake pads are installed, or other than recommended brake fluid is used, the braking properties of the vehicle can be degraded to an extent that safe braking is substantially impaired. This could result in an accident.

 **Vehicles with 4MATIC:** a function or performance test may only be carried out on a two-axle dynamometer. If you are planning to have the vehicle tested on such a dynamometer, contact an authorized Mercedes-Benz Center to obtain further information first. Otherwise, the drive train or the brake system may suffer damage.

 **Vehicles with 4MATIC:** as the ESP<sup>®</sup> system operates automatically, the engine and the ignition system must be switched off (SmartKey in position **0** or **1** in the ignition lock or Start/Stop button in position **0** or **1**) when:

- testing the parking brake on a brake dynamometer.
- you intend to have the vehicle towed with one of the axles raised.

Braking maneuvers triggered automatically by ESP<sup>®</sup> may seriously damage the brake system.

**! Vehicles with 4MATIC:** as the ESP® system operates automatically, the engine and the ignition must be switched off (SmartKey in position **0** or **1** in the ignition lock or Start/Stop button in position **0** or **1**) while the parking brake is being tested on a brake dynamometer (maximum 10 seconds).

Braking maneuvers triggered automatically by ESP® may seriously damage the brake system.

If your brake system is only subjected to moderate loads, you should regularly test your brake system's function by forcefully depressing the brake pedal when driving at high speed. This also improves the brake pads' friction.

#### **Warning**

Make sure that you do not endanger other road users when you apply the brakes.

You can find a description of Brake Assist (BAS) on (▷ page 66).

### **High-performance brake system for AMG vehicles**

The high-performance brake system is only installed on the ML 63 AMG.

#### **Warning**

New vehicle brake pads and discs, and replacement brake pads and discs may take several hundred miles of driving until they provide optimum braking efficiency. Until that time, you may need to use increased brake pedal pressure while braking. Please be aware of this and adjust your driving and braking accordingly during this break-in period.

Excessive high-demand braking will cause correspondingly high brake wear. Please be attentive to the brake warning lamp in the instrument cluster and brake condition messages in the multifunction display. Especially for high performance driving, it is important to maintain and have the brake system checked regularly.

The high-performance brake system is designed for heavy loads. This may lead to noise when braking. This will depend on:

- speed
- braking force
- environmental conditions, such as temperature and humidity

The wear of individual components of the brake system, such as the brake pads/linings or brake discs, depends on the individual driving style and operating conditions.

### **Parking brake**

If you drive on wet roads or dirt-covered surfaces, road salt and/or dirt could get into the parking brake.

In order to prevent corrosion and a reduction in the braking power of the parking brake, observe the following:

- gently depress the parking brake from time to time before beginning the journey.
- drive approximately 110 yd (100 m) without exceeding a speed of 12 mph (20 km/h).

#### **Warning!**

While performing this procedure please assure that the vehicle is stopped before applying the parking brake. Otherwise the rear wheels could lock up. You could lose control of the vehicle and cause an accident. In addition, the vehicle's brake lights do not light up when the parking brake is engaged. Make sure not to endanger any other road users when you engage the parking brake.

### **Driving on wet roads**

#### **Hydroplaning**

If water has accumulated to a certain depth on the road surface, there is a danger of hydroplaning occurring, even if:

- you drive at low speeds
- the tires have adequate tread depth

For this reason, in the event of heavy rain or in conditions in which hydroplaning can occur you must drive in the following manner:

- Lower your speed
- Avoid ruts
- Brake carefully

### Driving on flooded roads

**!** Do not drive through flooded areas. Check the depth of any water before driving through it. Drive slowly through standing water. Otherwise, water may enter the vehicle interior or the engine compartment. This can damage the electronic components in the engine or the automatic transmission. Water can also be drawn in by the engine's air suction nozzles and this can cause engine damage.

**i** **Vehicles with the AIRMATIC package:** set the raised vehicle level before driving through standing water.

### Off-road fording



P00.00-4332-31

① Fording depth

	Fording depth
<b>Steel-spring vehicles</b>	20 in. (50 cm)
<b>Vehicles with the AIRMATIC package</b>	
Raised level	20 in. (50 cm)

- Establish how deep the water is and the characteristics of the body of water before fording.

- **Vehicles with the AIRMATIC package:** select the highest possible vehicle level.
- Select the off-road drive program (▷ page 193).
- Restrict the shift range to **1** or **2**.
- Avoid high engine speeds.
- Enter and exit the water at a flat place and at a steady walking pace.

**!** Under no circumstances should you accelerate before entering the water. The bow wave could cause water to enter and damage the engine and other assemblies.

- Drive slowly and at an even speed through the water.
- Do not stop.

**!** Do not open any of the vehicle's doors while fording. Otherwise, water could get into the vehicle interior and damage the vehicle's electronics and interior equipment.

- Water offers a high degree of resistance, and the ground is slippery and in some cases unstable. Therefore, it is difficult and dangerous to pull away in the water.
- Ensure that a bow wave does not form as you drive.
- Clean any mud from the tire tread after fording.
- Apply the brakes to dry them after fording.

### Winter driving

#### Important safety guidelines

Have your vehicle winterproofed at a qualified specialist workshop, e.g. at an authorized Mercedes-Benz Center, at the onset of winter.

Observe the notes in the "Winter operation" section (▷ page 166).

- i** Vehicles with a diesel engine: do not cover the radiator, e.g. with a protective cover. The measuring function of the Onboard Diagnosis System may otherwise provide inaccurate values. Some of these values are required by law and must therefore always be accurate.

## Winter tires

Use winter tires at temperatures below 45 °F (7 °C) and on snow or ice-covered roads. Only winter tires also bearing the  provide the best-possible grip in wintry road conditions. Only these tires will allow the ABS and ESP® driving systems to function optimally in winter, as these tires have been designed specifically for driving on snow. Use M+S tires of the same make and tread on all wheels to maintain safe handling characteristics.

### Warning

M+S tires with a tread depth of less than  $\frac{1}{6}$  inch (4 mm) must be replaced. They are no longer suitable for winter operation.

Always observe the maximum permissible speed specified for the M+S tires you have installed.

Once you have installed the winter tires:

- ▶ Check the tire pressures (▷ page 329).
- ▶ Restart the tire pressure monitor (▷ page 331).

### Warning

If you use your spare wheel when M+S tires are fitted on the other wheels, be aware that the difference in tire characteristics may very well impair turning stability and that overall driving stability may be reduced. Adapt your driving style accordingly.

Have the spare wheel replaced by a regular road wheel with an M+S tire at the nearest authorized Mercedes-Benz Center.

## Snow chains

For safety reasons, Mercedes-Benz recommends that you only use snow chains which have been specially approved for your vehicle by Mercedes-Benz, or are of a corresponding standard of quality.

- !** Vehicles with the Adaptive Damping System (ADS): do not drive in ADS SPORT mode if snow chains have been mounted. The vehicle may otherwise be damaged.

- !** There is not enough space for snow chains on some wheel sizes. Observe the information under "Tires and wheels" in the "Technical Data" section to avoid damage to the vehicle or the wheels.

- Only use snow chains when driving on an area completely covered by snow. Do not exceed the maximum permissible speed of 30 mph (50 km/h). Remove the snow chains as soon as possible when you are no longer driving on snow-covered roads.
- Local regulations may restrict the use of snow chains. Applicable regulations must be observed if you wish to mount snow chains.
- Snow chains must not be mounted on emergency spare wheels.

If you intend to mount snow chains, please bear the following points in mind:

- you may not attach snow chains to all wheel-tire combinations; see the "Tires and wheels" section in the "Technical data" chapter.
- mount snow chains only in pairs and only on the rear wheels. Observe the manufacturer's installation instructions.

- !** If snow chains are mounted on the front wheels, the snow chains could grind against the bodywork or components of the chassis. This could result in damage to the vehicle or the tires.

- !** Vehicles with steel wheels

If you wish to mount snow chains to steel wheels, make sure that you remove the

respective wheels' hubcaps first. The hubcaps may otherwise be damaged.

- i** You may wish to deactivate ESP® (▷ page 66) when pulling away with snow chains installed. This way you can allow the wheels to spin in a controlled manner, achieving an increased driving force (cutting action).

### Slippery road surfaces

#### Warning

If the vehicle becomes stuck in snow, make sure snow is kept clear of the exhaust pipe and from around the vehicle with the engine running. Otherwise, deadly carbon monoxide (CO) gases may enter vehicle interior resulting in unconsciousness and death.

To assure sufficient fresh air ventilation, open a window slightly on the side of the vehicle not facing the wind.

#### Warning!

The outside temperature indicator is not designed to serve as an ice-warning device and is therefore unsuitable for that purpose. Indicated temperatures just above the freezing point do not guarantee that the road surface is free of ice. The road may still be icy, especially in wooded areas or on bridges.

#### Warning

On slippery road surfaces, never downshift in order to obtain braking action. This could result in drive wheel slip and reduced vehicle control. Your vehicle's ABS will not prevent this type of loss of control.

You should drive particularly carefully on slippery road surfaces. Avoid sudden acceleration, steering and braking maneuvers. Do not use cruise control. If the vehicle threatens to skid or cannot be stopped when moving at low speed:

- ▶ Shift the transmission to position **N**.

- i** For more information on driving with snow chains, see (▷ page 165).

#### Warning

Make sure that you do not endanger other road users when you apply the brakes.

### Driving off-road

### Important safety guidelines

#### Warning!

Grains of sand, particles of dirt and other abrasive materials can enter the brake system. This can lead to excessive wear and unpredictable braking efficiency.

After the brakes have been exposed to dirty conditions, have them checked and cleaned at a qualified specialist workshop, e.g. an authorized Mercedes-Benz Center.

Otherwise, there is a risk that braking power may be insufficient in the event of an emergency, or that the braking effect may be unpredictable.

#### Warning!

Do not load items on the basic carrier bars. It may cause instability during some maneuvers which could result in an accident.

Drive slowly in unknown terrain. This will make it easier to recognize unexpected obstacles and avoid damage to the vehicle.

To help avoid the vehicle rolling over, never turn it around on steep inclines. If the vehicle cannot complete the attempted climb, back it down in reverse gear.

Do not drive along the side of a slope. The vehicle might otherwise rollover. If in doing so the vehicle begins to show a tendency to roll, immediately steer into a line of gravity (straight up or downhill).

Never let the vehicle roll backwards in idle. You may lose control of the vehicle if you use only the service brake. For information on driving downhill, see "Driving downhill".

**⚠ Warning!**

Vehicles with air suspension program: Please be aware that by raising the vehicle level, the center of gravity also rises. Therefore, always ensure that the vehicle level is as low as possible. With higher ride height the ESP® may activate earlier in certain situations.

**⚠ Warning!**

Do not reduce the tire inflation pressure before driving through sand. However, if you do so, remember to correct the tire inflation pressure before continuing your trip. Driving with reduced tire inflation pressure increases the risk of losing control of the vehicle and rolling over.

**General information**

Read this section before driving your vehicle off-road. Practice by traveling over more gentle off-road terrain first.

Familiarize yourself with the characteristics of your vehicle and the gear change process before driving through difficult terrain.

The following driving systems are specially adapted to off-road driving:

- off-road drive program (▷ page 193)
- off-road ABS (▷ page 66)
- off-road 4ETS (▷ page 67)
- off-road ESP® (▷ page 68)
- hill start assist
- AIRMATIC package (▷ page 183)
- DSR (Downhill Speed Regulation) (▷ page 192)

Observe the following notes:

- stop your vehicle and, if necessary, select the off-road drive program (▷ page 193) before driving off-road.
- vehicles with the AIRMATIC package: select a vehicle level that is suitable for the terrain. Make sure there is always sufficient ground clearance to prevent damage to the vehicle.

- make sure that items of luggage and cargo are stowed safely and are well secured (▷ page 260).
- always keep the engine running and in gear when driving on a downhill gradient. Activate DSR (▷ page 192).
- always keep the doors, tailgate, windows and the tilt/sliding sunroof closed while the vehicle is in motion.
- adapt the speed to suit the terrain conditions. The more uneven, worn or steeper the terrain is, the slower you should drive.
- drive slowly and at an even speed through the water. Ensure that a bow wave does not form as you drive.
- drive with extreme care on unfamiliar off-road routes where visibility is poor. For safety reasons, get out of the vehicle first and survey the off-road route.
- look out for obstacles, such as rocks, holes, tree stumps and furrows.
- check the depth of water before fording rivers and streams.
- do not stop in water and do not switch the engine off.
- drive quickly on sand to overcome the rolling resistance. Otherwise, the vehicle could dig itself into the sand.
- do not jump with the vehicle. This interrupts the vehicle's traction.
- always keep the engine running and in gear when driving on slopes.
- do not shift the automatic transmission to transmission position **N**.

**Check list before driving off-road**

- **Engine oil level:** check the engine oil and top it up if necessary.

The oil supply can only be guaranteed on steep slopes if the engine oil level is sufficient.

- ❗ If the engine oil warning lamp lights up while the vehicle is in motion, stop the

vehicle in a safe place as soon as possible. Check the engine oil level. The engine oil warning lamp warning must not be ignored. Continuing the journey while the symbol is displayed could lead to engine damage.

- ▶ **Wheel-changing tool kit:** check that the jack is working and make sure you have the wheelbrace, a robust tow cable and a folding spade in the vehicle.
- ▶ **Wheels and tires:** check the tire tread depth and tire pressure. A table with the recommended tire pressures can be found on the B-pillar on the driver's side of your vehicle.
- ▶ Check for damage and remove any foreign objects, e.g. small stones, from the wheels/tires.
- ▶ Replace any missing valve caps.
- ▶ Replace dented or damaged wheels.
- ▶ **Wheels:** dented or deformed wheels could result in a loss of tire pressure and damage the tire bead. Therefore, check the wheels before driving off-road and replace them if necessary.

### Check list after driving off-road

#### Warning

If you feel a sudden significant vibration or ride disturbance, or you suspect that possible damage to your vehicle has occurred, you should turn on the hazard warning flashers, carefully slow down, and drive with caution to an area which is a safe distance from the road.

Inspect the tires and the vehicle underbody for possible damage. If the vehicle appears unsafe, have the vehicle towed to the nearest authorized Mercedes-Benz Center or tire dealer for repairs.

Driving over rough terrain places greater demands on your vehicle than driving on normal roads. After driving off-road, check the vehicle. This allows you to detect damage promptly and reduce the risk of an accident to yourself and other road users.

- ▶ Deactivate the off-road drive program (▷ page 193).
- ▶ Deactivate DSR (▷ page 192).
- ▶ Vehicles with the AIRMATIC package: lower the vehicle to a level that suits the road conditions, e.g. highway/high-speed level.
- ▶ Clean the headlamps and rear lights and check for damage.
- ▶ Clean the front and rear license plates.
- ▶ Clean the wheels/tires, wheel arch and the underbody with a water jet. Check for damage and remove any foreign objects.
- ▶ After the trip, examine without fail the entire undercarriage, wheels, tires, brakes, bodywork structure, steering, chassis and exhaust system for damage.
- ▶ Check whether twigs or other parts of plants have become trapped. These increase the risk of fire and can damage fuel pipes, brake hoses or the rubber bellows of the axle joints and propeller shafts.
- ▶ After driving for extended periods across sand, mud, gravel, water or in similarly dirty conditions, have the brake discs, wheels, brake pads/linings and axle joints checked and cleaned.
- ▶ If you detect strong vibrations after off-road travel, check for foreign objects in the wheels and drive train and remove them if necessary. Foreign objects can disturb the balance and cause vibrations.
- ▶ Test the brakes.

### Driving on sand

#### Warning!

Do not reduce the tire inflation pressure before driving through sand. However, if you do so, remember to correct the tire inflation pressure before continuing your trip. Driving with reduced tire inflation pressure increases the risk of losing control of the vehicle and rolling over.

Observe the following rules when driving on sand:

- vehicles with the AIRMATIC package: select a raised vehicle level.
- avoid high engine speeds.
- select a shift range appropriate to the terrain.
- drive quickly to overcome the rolling resistance. Otherwise, the vehicle could dig itself into the sand.
- drive in the tracks of other vehicles if possible. Make sure that the ruts are not too deep, that the sand is firm enough and that your vehicle has sufficient ground clearance.

### Tire ruts and gravel roads

Observe the following rules when driving along ruts in off-road terrain or on roads with loose gravel:

- ❗ Check that the ruts are not too deep and that your vehicle has sufficient clearance. Otherwise, your vehicle could be damaged or bottom out and get stuck.
- select the off-road drive program (▷ page 193).
- vehicles with the AIRMATIC package: select a raised vehicle level.
- avoid high engine speeds.
- select shift range 1.
- drive slowly.
- where ruts are too deep, drive with the wheels on one side on the middle section of turf if possible.

### Crossing obstacles



P00.00-4333-31

❗ Obstacles could damage the floor of the vehicle or components of the chassis. Ask passengers for guidance when driving over large obstacles. The passenger should always keep a safe distance from the vehicle when doing so in order to avoid injury as a result of unexpected vehicle movements. After driving off-road or over obstacles, check the vehicle for possible damage, especially to the underbody and the components of the chassis.

Observe the following rules when driving over tree stumps, large stones and other obstacles:

- select the off-road drive program (▷ page 193).
- avoid high engine speeds.
- select shift range 1.
- drive very slowly.
- drive straight over the center of obstacles: front wheel first, then rear wheel.

## Driving in mountainous terrain

### Approach/departure angle

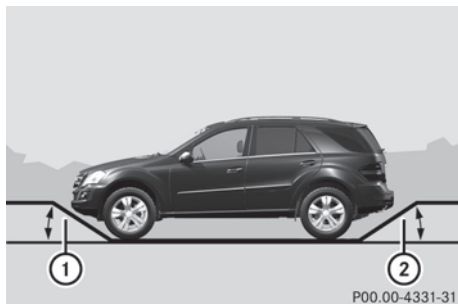

- ① Approach/departure angle, front  
 ② Approach/departure angle, rear

	①	① <sup>27</sup>	②
<b>Steel-spring vehicles</b>	27°	22°	26°

	①	① <sup>28</sup>	②
<b>Vehicles with the AIRMATIC package</b>			
Raised level	31°	25°	29°
Highway level	25°	18°	24°

	①	②
<b>AMG vehicles</b>		
Raised level	26°	28°
Highway level	21°	24°

- Comply with the rules for off-road driving.
- Do not drive at an angle on slopes, inclines or gradients, but instead follow the direct line of fall. The maximum gradient-climbing capability of your vehicle is 100%, which corresponds to an approach/departure angle of 45°. Note that the vehicle's

gradient-climbing capability depends on the off-road conditions.

- Before tackling steep downhill gradients, select shift range 1.
- Drive slowly.
- Avoid high engine speeds – drive at a suitable engine speed (maximum 3000 rpm).
- Use the braking power of the engine when driving down a slope. Observe the engine speed, do not overrev the engine.
- Check the brakes after driving off-road for a long time.

### **Warning!**

Never turn the vehicle around on steep inclines. The vehicle might roll over. If the vehicle cannot complete the attempted climb, back it down in reverse gear.

- i** Hill start assist will aid you when pulling away on a hill.

For more information, see "Hill start assist" (▷ page 142).

### **Maximum gradient climbing ability**

On good road surfaces, the maximum gradient climbing capability of your vehicle is 100%, which corresponds to an approach/departure angle of 45°. Note that the vehicle's gradient-climbing capability depends on the off-road conditions.

Accelerate carefully and make sure that the wheels do not spin when driving on steep terrain.

- i** If the load on the front axle is reduced when pulling away on a steep uphill slope, the front wheels have a tendency to spin. 4ETS recognizes this and brakes the wheels accordingly. The rear wheel torque is increased and it is easier to pull away.

<sup>27</sup> Vehicles with the AMG Sports package.

<sup>28</sup> Vehicles with the AMG Sports package.

## Hilltops

When driving up an uphill gradient, slightly reduce pressure on the accelerator immediately before reaching the brow of the hill. Make use of the vehicle's own impetus to travel over the brow.

This style of driving prevents:

- the vehicle from lifting off the ground on the brow of a hill
- loss of traction
- the vehicle from traveling too quickly down the other side

## Driving downhill

- Drive slowly.
  - Do not drive at an angle down steep inclines. Steer into the line of fall and drive with the front wheels aligned straight. Otherwise, the vehicle could slip sideways, tip and rollover.
  - Before tackling steep downhill gradients, select shift range **1**.
  - Activate DSR. If this is not sufficient, brake gently. When doing so, make sure that the vehicle is facing in the direction of the line of fall.
  - Check that the brakes are working normally after a long downhill stretch.
- i** The special off-road ABS setting enables the front wheels to be locked accurately, briefly and repeatedly, causing them to dig into the loose ground. Note that when the front wheels are fully braked, they slide easily over the ground surface and therefore steering is impaired.

## Driving abroad

An extensive Mercedes-Benz Service network is also available in other countries. The Service Hotline's current telephone numbers for use when you are abroad are to be found in the "Service24h" section of the Service Booklet.

## Driving systems

### Cruise control

#### Important safety guidelines

Cruise control maintains a constant road speed for you. It brakes automatically in order to avoid exceeding the set speed. On long and steep downhill gradients, especially if the vehicle is laden or towing a trailer, you must select shift range **1**, **2** or **3** in good time. By doing so, you will make use of the braking effect of the engine, which relieves the load on the brake system and prevents the brakes from overheating and wearing too quickly.

Use cruise control only if road and traffic conditions make it appropriate to maintain a steady speed for a prolonged period. You can store any road speed above 20 mph (30 km/h).

#### Warning

The cruise control is a convenience system designed to assist the driver during vehicle operation. The driver is and must always remain responsible for the vehicle's speed and for safe brake operation.

Only use the cruise control if the road, traffic, and weather conditions make it advisable to travel at a constant speed.

- The use of the cruise control can be dangerous on winding roads or in heavy traffic because conditions do not allow safe driving at a constant speed.
- The use of the cruise control can be dangerous on slippery roads. Rapid changes in tire traction can result in wheel spin and loss of control.
- Deactivate the cruise control when driving in fog.

The "Resume" function should only be operated if the driver is fully aware of the previously set speed and wishes to resume this particular preset speed.

**Warning**

When cruise control brakes, the brake pedal is pulled back (i.e. operated automatically). The area around the pedal must not be blocked by obstacles:

- Do not place any objects in the footwell.
- Ensure that floor mats and carpets are fixed securely. In particular, do not place several floor mats on top of one another.
- Do not place your foot under the brake pedal, as it could become trapped.

Non-compliance could lead you to cause an accident in which you and/or others could be seriously injured.

- i** Cruise control should not be activated during off-road driving.

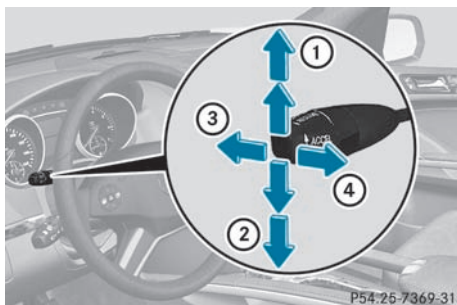
**Cruise control lever**

- ① To store the current speed or a higher speed
- ② To store the current speed or a lower speed
- ③ To deactivate cruise control
- ④ To store the current speed or to call up the last stored speed

When you activate cruise control, the stored speed is shown in the status indicator of the multifunction display:

- USA only: e.g. CRUISE 55 Miles
- Canada only: e.g.  90 Km/h

**Storing and maintaining the current speed**

You can store the current speed if you are driving faster than 20 mph (30 km/h).

- ▶ Accelerate the vehicle to the desired speed.
- ▶ Briefly press the cruise control lever up ① or down ② to the pressure point.
- ▶ Remove your foot from the accelerator pedal. Cruise control is activated. The vehicle automatically maintains the stored speed.

- i** Cruise control may be unable to maintain the stored speed on uphill gradients. The stored speed is resumed when the gradient evens out. Cruise control maintains the stored speed on downhill gradients by automatically applying the brakes.

**Storing the current speed or calling up the last speed stored****Warning**

The set speed stored in memory should only be set again if prevailing road conditions and legal speed limits permit. Possible acceleration or deceleration differences arising from returning to the preset speed could cause an accident and/or serious injury to you and others.

- ▶ Briefly pull the cruise control lever towards you ④.
- ▶ Remove your foot from the accelerator pedal. The first time cruise control is activated, it stores the current speed or regulates the speed of the vehicle to the previously stored speed.

## Setting a speed

### Warning

Keep in mind that it may take a brief moment until the vehicle has made the necessary adjustments.

Increase or decrease the set vehicle speed to a value that the prevailing road conditions and legal speed limits permit. Otherwise, sudden and unexpected acceleration or deceleration of the vehicle could cause an accident and/or serious injury to you and others.

- ▶ Press the cruise control lever to the pressure point, up ① for a higher speed or down ② for a lower speed.
  - ▶ Keep the cruise control lever pressed until the desired speed is reached.
  - ▶ Release the cruise control lever. The new speed is stored.
- i** Cruise control is not deactivated if you depress the accelerator pedal. For example, if you accelerate briefly to overtake, cruise control adjusts the vehicle's speed to the last speed stored after you have finished overtaking.

## Setting in 1 mph (Canada: 1 km/h) increments

- ▶ Briefly press the cruise control lever to the pressure point, up ① for a higher speed or down ② for a lower speed. The last speed stored is increased or reduced.

## Setting in 5 mph (Canada: 10 km/h) increments

- ▶ Briefly press the cruise control lever beyond the pressure point, up ① for a higher speed or down ② for a lower speed. The last speed stored is increased or reduced.

## Deactivating cruise control

There are several ways to deactivate cruise control:

- ▶ Briefly press the cruise control lever forwards ③.

or

- ▶ Brake.

Cruise control is automatically deactivated if:

- you depress the parking brake.
- you are driving below 20 mph (30 km/h).
- ESP® intervenes or you deactivate ESP®.
- you shift the transmission to position **N** while driving.

If cruise control is deactivated, you will hear a warning tone. You will see the Cruise control Off message in the multifunction display for approximately five seconds.

- i** The last speed stored is cleared when you switch off the engine.

## DISTRONIC

### Important safety guidelines

DISTRONIC regulates the speed and automatically helps you maintain the distance to the vehicle detected in front. It brakes automatically in order to avoid exceeding the set speed.

On long and steep downhill gradients, especially if the vehicle is laden or towing a trailer, you must select shift range **1**, **2** or **3** in good time. By doing so, you will make use of the braking effect of the engine, which relieves the load on the brake system and prevents the brakes from overheating and wearing too quickly.

If a slower-moving vehicle is detected in front, DISTRONIC causes your vehicle to brake and maintain the preset distance to the vehicle in front.

**⚠ Warning!**

The DISTRONIC requires familiarity with its operational characteristics. We strongly recommend that you review the following information carefully before operating the system.

**⚠ Warning!**

HYBRID vehicles: It is imperative that you read the HYBRID Supplemental Operating Instructions included in your vehicle literature portfolio. You may otherwise not receive all necessary safety information and warning for the operation of your vehicle.

**⚠ Warning**

When DISTRONIC brakes, the brake pedal is pulled back (i.e. operated automatically). The area around the pedal must not be blocked by obstacles:

- do not place any objects in the footwell.
- ensure that floor mats and carpets are fixed securely. In particular, do not place several floor mats on top of one another.
- do not place your foot under the brake pedal, as it could become trapped.

Non-compliance could lead you to cause an accident in which you and/or others could be seriously injured.

**⚠ Warning!**

The DISTRONIC is a convenience system. Its speed adjustment reduction capability is intended to make cruise control more effective and usable when traffic speeds vary. It is not however, intended to, nor does it, replace the need for extreme care.

The responsibility for the vehicle's speed, distance to the preceding vehicle and, most importantly, brake operation to ensure a safe stopping distance, always remains with the driver.

The DISTRONIC cannot take street and traffic conditions into account. Complex driving situations are not always fully recognized by

the DISTRONIC. This could result in wrong or missing distance warnings.

If there is no vehicle in front, DISTRONIC operates in the same way as cruise control in the speed range between 20 mph (30 km/h) and 120 mph (200 km/h). If there is a vehicle in front, DISTRONIC operates in the speed range between 0 mph (0 km/h) and 120 mph (200 km/h).

Do not use DISTRONIC while driving on roads with steep gradients.

**⚠ Warning**

DISTRONIC distance control is not a substitute for the driver's active involvement. It does not react to pedestrians or stationary objects and cannot detect or predict the road's course and the movements of the vehicles in front.

DISTRONIC can only brake using 40% of the vehicle's maximum possible braking force.

The driver must always pay attention to road, weather and traffic conditions. He must steer, brake and drive the vehicle so that he maintains control over it.

High-frequency sources such as toll stations, velocity measurement systems, etc. may cause DISTRONIC to malfunction.

**⚠ Warning!**

The DISTRONIC cannot take road and traffic conditions into account. Only use the DISTRONIC if the road, weather and traffic conditions make it advisable to travel at a constant speed.

**⚠ Warning!**

Use of the DISTRONIC can be dangerous on slippery roads. Rapid changes in tire traction can result in wheel spin and loss of control.

The DISTRONIC does not function in adverse sight and distance conditions. Do not use the DISTRONIC during conditions of fog, heavy rain, snow or sleet.

**⚠ Warning!**

The DISTRONIC cannot take weather conditions into account. Switch off the DISTRONIC or do not switch it on if:

- roads are slippery or covered with snow or ice. The wheels could lose traction while braking or accelerating, and the vehicle could skid.
- the DISTRONIC system sensor cover is dirty or visibility is diminished due to snow, rain or fog, for example. The distance control system functionality could be impaired.

Always pay attention to surrounding traffic conditions even while the DISTRONIC is switched on. Otherwise, you may not be able to recognize dangerous situations until it is too late. This could cause an accident in which you and/or others could be injured.

**⚠ Warning!**

The "Resume" function should only be operated if the driver is fully aware of the previously set speed and wishes to resume this particular preset speed.

**⚠ Warning!**

Close attention to road and traffic conditions is imperative at all times, regardless of whether or not the DISTRONIC is activated.

Use of the DISTRONIC can be dangerous on winding roads or in heavy traffic because conditions do not allow safe driving at a constant speed.

The DISTRONIC will not react to stationary objects in the roadway (e.g. a stopped vehicle in a traffic jam or a disabled vehicle). The DISTRONIC will also not respond to oncoming vehicles.

Switch off the DISTRONIC

- when changing from the left to the right lane if vehicles are moving more slowly in the left lane
- when entering a turn lane or highway off ramp
- in complex driving situations, such as in highway construction zones

In these situations, the DISTRONIC will continue to maintain the set speed unless deactivated.

The DISTRONIC is designed and intended only to maintain a set speed and keep a set distance from moving objects in front of it.

**i** This device has been approved by the FCC as a "Vehicular Radar System". The radar sensor is intended for use in an automotive radar system only. Removing, tampering with, or altering the device will void any warranties, and is forbidden by the FCC. Do not tamper with, alter or use in any non-approved way.

Any unauthorized modification to this device may invalidate the vehicle's general operating permit.

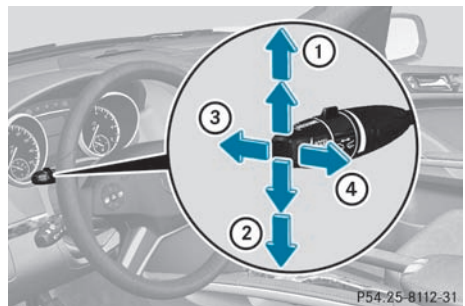
**Cruise control lever**

- ① To store the current speed or a higher speed
- ② To store the current speed or a lower speed
- ③ To deactivate DISTRONIC
- ④ To store the current speed or to call up the last stored speed

P54-25-8112-31

## Activating DISTRONIC, storing and maintaining the current speed

### Warning!





The vehicle can be braked when DISTRONIC is activated. For this reason, deactivate DISTRONIC if the vehicle is to be set in motion by other means (e.g. in a car wash or by towing).

You can activate DISTRONIC in the following circumstances:

- if the engine has been started and you have been driving for up to two minutes
- while driving, except if you brake
- if the parking brake is not applied
- if ESP® is activated
- if the transmission is in position **D**

## Activating while driving

When driving at speeds below 20 mph (30 km/h), you can only activate DISTRONIC PLUS if the vehicle in front has been detected and is shown in the multifunction display. If the vehicle in front is not shown in the multifunction display and is no longer being detected, because it has changed lanes, for example, DISTRONIC is deactivated and you hear a warning tone.

- ▶ Briefly pull the cruise control lever towards you  or press it up  or down  to the pressure point. DISTRONIC is activated.
- ▶ Keep the cruise control lever pressed up  or down  until the desired speed is set.
- ▶ Remove your foot from the accelerator pedal. Your vehicle adapts its speed to that of the vehicle in front, but only up to the desired stored speed.

- i** You can use the cruise control lever to set the stored speed and the thumbwheel on the cruise control lever to set the specified minimum distance (> page 177).

- i** If you do not fully release the accelerator pedal, the DISTRONIC Override message appears in the multifunction display. The set distance to a slower-moving vehicle in front will then not be maintained. You will be driving at the speed you determine by the position of the accelerator pedal.

## Driving

If there is no vehicle in front, DISTRONIC operates in the same way as cruise control.

If a slower-moving vehicle is detected in front, DISTRONIC causes your vehicle to brake and maintain the preset distance to the vehicle in front.

If DISTRONIC detects a faster-moving vehicle in front, it increases the driving speed, but only up to the desired speed you have stored.

### Warning!

If you depress the brake pedal, DISTRONIC is deactivated. DISTRONIC will then no longer brake your vehicle. In such cases, control the distance from vehicles traveling in front with the brake alone. You could otherwise cause an accident and thereby injure yourself and others. The driver remains fully responsible for the vehicle's distance from other vehicles, the speed being driven and for braking in good time.

## Stopping

### Warning!

DISTRONIC must never be operated, activated or deactivated by a passenger or from outside the vehicle.

If DISTRONIC detects that the vehicle in front is stopping, it brakes your vehicle until it is stationary.

- i** Depending on the specified minimum distance, your vehicle will come to a standstill at a sufficient distance behind the vehicle in front. The specified minimum distance is set using the thumbwheel on the cruise-control lever.

DISTRONIC is deactivated automatically when stopping:

- on flat stretches of road or on downhill gradients when the vehicle is stationary
- while the vehicle is still moving on uphill gradients, to prevent the vehicle from unexpectedly rolling back when DISTRONIC is deactivated

If DISTRONIC is deactivated, you will hear a warning tone.

- ▶ To prevent the vehicle from rolling away, apply the foot brake or parking brake.

### Setting a speed

#### Warning

Keep in mind that it may take a brief moment until the vehicle has made the necessary adjustments.

Increase or decrease the set vehicle speed to a value that the prevailing road conditions and legal speed limits permit. Otherwise, sudden and unexpected acceleration or deceleration of the vehicle could cause an accident and/or serious injury to you and others.

- ▶ Press the cruise control lever to the pressure point, up ① for a higher speed or down ② for a lower speed.
- ▶ Keep the cruise control lever pressed until the desired speed is reached.
- ▶ Release the cruise control lever. The new speed is stored. DISTRONIC is activated and adjusts the vehicle's speed to the new speed stored.

### Setting in 1 mph (Canada: 1 km/h) increments

- ▶ Briefly press the cruise control lever to the pressure point, up ① for a higher speed or down ② for a lower speed. The last speed stored is increased or reduced.

### Setting in 5 mph (Canada: 10 km/h) increments

- ▶ Briefly press the cruise control lever beyond the pressure point, up ① for a higher speed or down ② for a lower speed. The last speed stored is increased or reduced.

### Storing the current speed or calling up the last speed stored

#### Warning

The set speed stored in memory should only be set again if prevailing road conditions and legal speed limits permit. Possible acceleration or deceleration differences arising from returning to the preset speed could cause an accident and/or serious injury to you and others.

- ▶ Briefly pull the cruise control lever towards you ④.
- ▶ Remove your foot from the accelerator pedal. DISTRONIC is activated and accepts the current speed if it is activated for the first time, or adjusts the vehicle's speed to the last speed stored.

### Setting the specified minimum distance

You can set the specified minimum distance for DISTRONIC by varying the time span between one and two seconds. This time span determines the distance that DISTRONIC should maintain from the vehicle in front, depending on the road speed. You can see this distance in the multifunction display (▷ page 179).

#### Warning!

It is up to the driver to exercise discretion to select the appropriate setting given road conditions, traffic, driver's preferred driving style and applicable laws and driving recommendations for safe following distance.

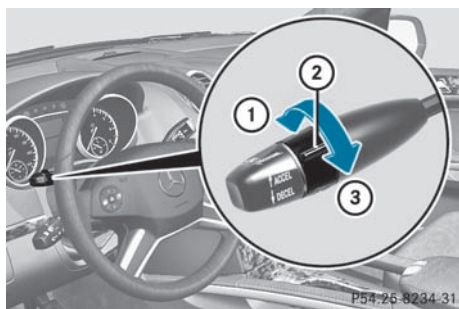

- ▶ **To increase:** turn thumbwheel ② towards ③.

DISTRONIC then maintains a greater distance between your vehicle and the vehicle in front.

- ▶ **To decrease:** turn thumbwheel ② towards ①.

DISTRONIC then maintains a shorter distance between your vehicle and the vehicle in front.

- ⓘ Make sure that you maintain the minimum distance to the vehicle in front as required by law. Adjust the distance to the vehicle in front if necessary.

### DISTRONIC displays in the speedometer



When DISTRONIC is activated, one or two segments in the set speed range light up.

- ⓘ For design reasons, the speed displayed in the speedometer may differ slightly from the speed set for DISTRONIC.

If DISTRONIC detects a vehicle in front, segments ② between the speed of the vehicle in front ① and stored speed ③ light up.

#### ⚠ Warning!

An intermittent warning sounds and the distance warning lamp  in the instrument cluster is illuminated if the DISTRONIC system calculates that the distance to the vehicle ahead and your vehicle's current speed indicate that the DISTRONIC will not be capable of slowing the vehicle sufficiently to maintain the preset following distance, which creates a danger of a collision.

Immediately brake the vehicle to increase your distance to the preceding vehicle. The warning sound is intended as a final caution in which you should intercede with your own braking inputs to avoid a potentially dangerous situation. Do not wait for the operation of the warning signal to intercede with your own braking. This will result in potentially dangerous emergency braking which will not always result in an impact being avoided.

Tailgating increases the risk of an accident.

#### ⚠ Warning



DISTRONIC brakes your vehicle with a maximum deceleration of 13 ft/s<sup>2</sup> (4 m/s<sup>2</sup>). This corresponds to approximately 40% of your vehicle's maximum possible braking power.

You must apply the brakes yourself to avoid a collision. DISTRONIC brakes the vehicle to restore the set distance to the vehicle in front or to restore the set speed. In this case, the brake pedal is depressed automatically, which can be seen by a movement of the brake pedal.

Always keep the driver's footwell clear, including the area under the brake pedal. Objects in this area may impair pedal movement and cause the DISTRONIC braking function to malfunction.

Do not place your foot under the brake pedal – your foot could become caught.

## DISTRONIC displays in the multifunction display

► Press the  or  button to select the DISTRONIC menu (► page 207).

### Display when DISTRONIC is switched off

When DISTRONIC is deactivated, you will see the following in the multifunction display:

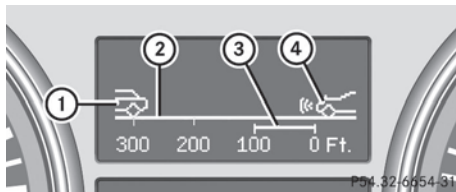

- ① Vehicle in front, if detected
- ② Distance indicator, displaying current distance to the vehicle in front
- ③ Specified minimum distance to the vehicle in front, adjustable
- ④ Own vehicle

### Display when DISTRONIC is activated

After this time, you will see the following in the multifunction display while DISTRONIC is activated:

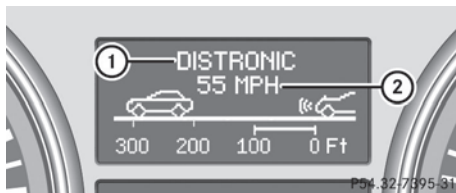

- ① DISTRONIC activated
- ② Stored speed

When activating DISTRONIC and when setting the speed, stored speed ② appears for around five seconds.

After approximately five seconds, current saved speed ② is shown in the status indicator in the multifunction display DTR XXX Miles.

## Deactivating DISTRONIC



There are a number of ways to deactivate DISTRONIC:

► Briefly press the cruise control lever forwards ①.

or

► Brake.

**i** The last speed stored remains stored until you switch off the engine.

**i** DISTRONIC is not deactivated if you depress the accelerator pedal. If you accelerate to overtake, DISTRONIC adjusts the vehicle's speed to the last speed stored after you have finished overtaking.

DISTRONIC is automatically deactivated if:

- you apply the parking brake.
- you are driving slower than 20 mph (25 km/h) and there is no vehicle in front, or if the vehicle in front is no longer detected.
- ESP® intervenes or if you deactivate ESP®.
- you shift the transmission to **P**, **R** or **N**.

If DISTRONIC is deactivated, you will hear a warning tone. You will see the DISTRONIC Off message in the multifunction display for approximately five seconds.

## Tips for driving with DISTRONIC

The following contains descriptions of certain road and traffic conditions in which you must be particularly attentive. In such situations,

brake if necessary. DISTRONIC is then deactivated.

### **Warning!**

The DISTRONIC works to maintain the speed selected by the driver unless a moving obstacle proceeding directly ahead of it in the same travel direction is detected (e.g. following another vehicle ahead of you at your set distance).

This means that:

- Your vehicle can pass another vehicle after you have changed lanes.
- While in a sharp turn or if the preceding vehicle is in a sharp turn, the DISTRONIC could lose sight of the preceding vehicle. Your vehicle could then accelerate to the previously selected speed.

The DISTRONIC regulates only the distance between your vehicle and those directly ahead of it, but does not register stationary objects in the road, e.g.:

- a stopped vehicle in a traffic jam
- a disabled vehicle
- an oncoming vehicle

The driver must always be alert, observe all traffic and intercede as required by means of steering or braking the vehicle.

### **Warning!**

The DISTRONIC should not be used in snowy or icy road conditions.

## Cornering, going into and coming out of a bend

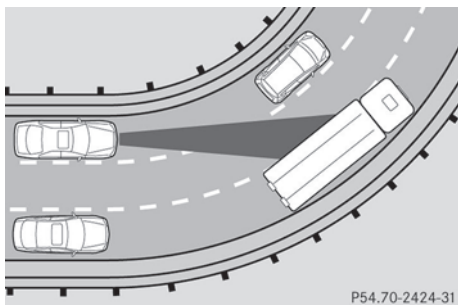

The ability of DISTRONIC to detect vehicles when cornering is limited. Your vehicle may brake unexpectedly or late.

## Vehicles traveling on a different line

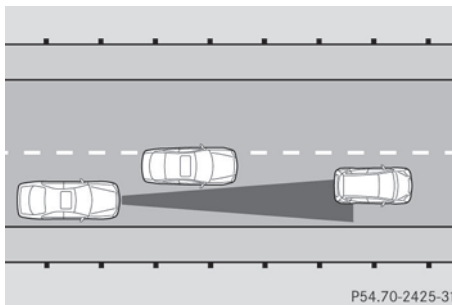

DISTRONIC may not detect vehicles traveling on a different line. The distance to the vehicle in front will be too short.

## Other vehicles changing lane

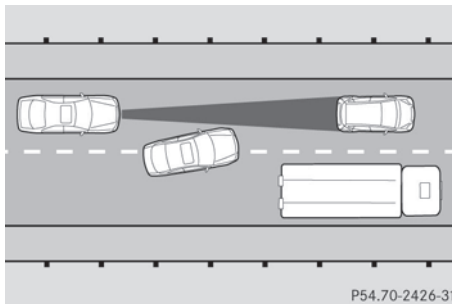

DISTRONIC has not detected the vehicle cutting in yet. The distance to this vehicle will be too short.

## Narrow vehicles

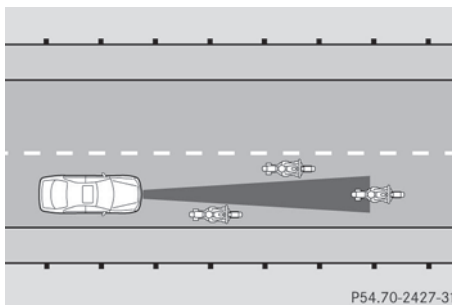

DISTRONIC has not yet detected the vehicle in front on the edge of the road, because of its narrow width. The distance to the vehicle in front will be too short.

### Obstructions and stationary vehicles

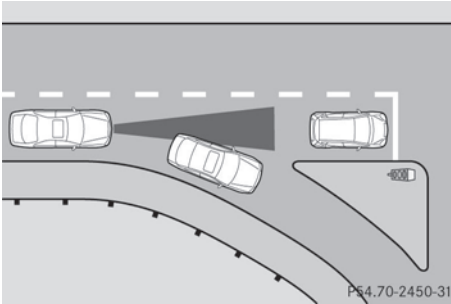

DISTRONIC does not brake for obstructions or stationary vehicles. If, for example, the detected vehicle turns a corner and reveals an obstacle or stationary vehicle, DISTRONIC will not brake for these.

### Crossing vehicles

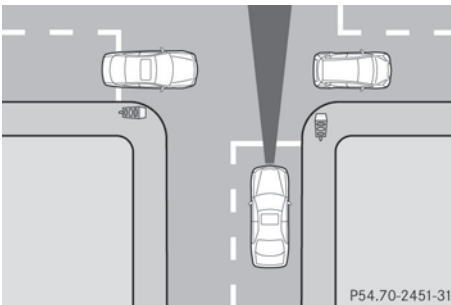

DISTRONIC may detect vehicles that are crossing your lane by mistake. Activating DISTRONIC at, for example, a traffic light with crossing traffic, could cause your vehicle to pull away at the wrong time.

## Level control

### Important safety guidelines

Level control automatically adapts the vehicle level to the current operating and driving

situation. This results in reduced fuel consumption and improved handling.

When you are driving in **ADS COMF** or **AUTO ADS** (▷ page 184), the vehicle is automatically lowered to high-speed level as the speed increases. As the vehicle speed decreases, the vehicle is raised back up to highway level.

In **ADS SPORT** (▷ page 184), the vehicle skips highway level and, depending on the basic setting, lowers directly to high-speed level (▷ page 182).

Make changes to the vehicle level while the vehicle is in motion. This enables the vehicle to adjust to the new level as quickly as possible.

The vehicle level may change visibly if you park the vehicle and the outside temperature changes. If the temperature drops, the vehicle level is lower; with an increase in temperature, the vehicle level rises.

When you unlock the vehicle or open a door, the vehicle begins to balance the load discrepancies while still parked. However, for significant level changes, e.g. after the vehicle has been stationary for a long period, the engine must be on. For safety reasons, the vehicle is only lowered when the doors are closed. Lowering is interrupted if a door is opened, and it continues once the door has been closed.

#### **Warning!**

Make sure that nobody is in the vicinity of the wheel arch or the underbody when changing the vehicle level. You could otherwise trap yourself or others.

#### **Warning!**

Always select as low a vehicle level as possible. If the vehicle level is high, the vehicle center of gravity shifts upwards. This increases the risk of the vehicle tipping over. Adapt your driving style to suit the vehicle level. ESP® cannot reduce the risk of an

accident if you drive too fast. ESP® cannot override the laws of physics.

**!** When driving on extremely rough terrain, select a high vehicle level in good time. Make sure that there is always sufficient ground clearance to prevent damage to the vehicle.

**!** Remove the key from the ignition before raising one or more wheels with the appropriate equipment.

Information on "Off-road driving"; see (▷ page 166).

## Level setting

### Basic settings, excluding AMG vehicles

The extent to which the vehicle is raised or lowered depends on the basic setting selected. Select raised level for off-road driving or highway/high-speed level for normal roads.

The individual vehicle levels differ from highway level as follows:

- +2.3 in (+ 60 mm) in raised level
- +/-0 in (+/-0 mm) in highway level
- -0.6 in (-15 mm) in high-speed level

**i** The high-speed level is not available when you are towing a trailer. Observe the notes on driving with a trailer (▷ page 198).

### Basic settings for AMG vehicles

The extent to which the vehicle is raised or lowered depends on the ADS setting selected. Select raised level for off-road driving or highway/high-speed level for normal roads.

In raised level, the vehicle is 2.9 in (73 mm) higher than in Highway level with **ADS AUTO**.

### Raised level

Only select raised level if this is appropriate for the road conditions. Otherwise, fuel

consumption may increase and handling may be affected.

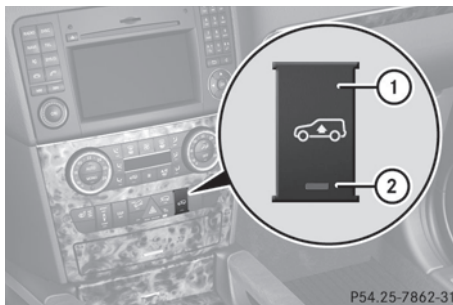

- ▶ Start the engine.
- ▶ Press button ①. Indicator lamp ② flashes. The vehicle rises to raised level.

While the adjustment is taking place, a message appears in the multifunction display, e.g.:

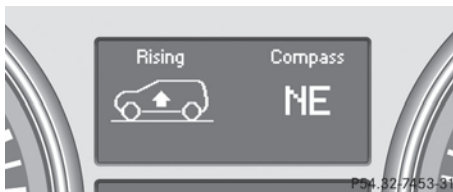

If you press the or button on the multifunction steering wheel, the message will disappear.

Once the vehicle has reached raised level, indicator lamp ② remains lit. You will see a message in the multifunction display, for example:



If you want to select raised level at a speed above 40 mph (64 km/h), the Level Selection Not Permitted message appears in the multifunction display.

### Highway/high-speed level

**!** Make sure that there is enough ground clearance when the vehicle is being lowered. It could otherwise hit the ground, damaging the underbody.

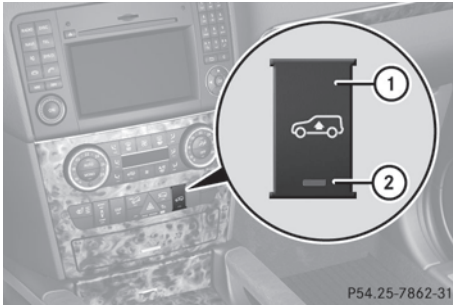





▶ Start the engine.

If indicator lamp ② is lit:

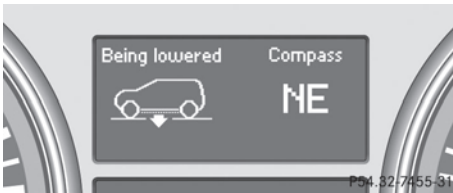
▶ Press button ①.  
Indicator lamp ② flashes. The vehicle is adjusting to highway/high-speed level.

While the adjustment is taking place, a message appears in the multifunction display, e.g.:



If you press the , ,  or  button on the multifunction steering wheel, the message will disappear.

Once highway level has been reached, indicator lamp ② goes out. You will see a message in the multifunction display, for example:

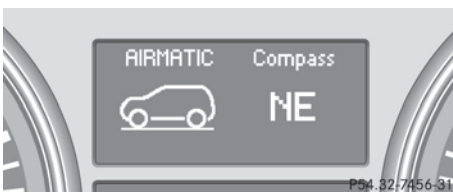

The vehicle is automatically lowered to high-speed level if you are driving at speeds above 55 mph (88 km/h) or for approximately 20 seconds between 40 mph (64 km/h) and 55 mph (88 km/h).

### AIRMATIC package

#### General notes

AIRMATIC enables a suspension tuning setting to be selected and regulates the damping behavior and level of your vehicle. The system comprises two components: ADS (Adaptive Damping System) (> page 184) and level control (> page 181).

Observe the notes on driving with a trailer (> page 198).

#### AMG vehicles

The AIRMATIC package is part of the standard equipment. Due to the sportier suspension tuning when compared to standard vehicles, the level positions in the ADS settings and the speed thresholds for raising and lowering the vehicle are different.

The vehicle is lowered from highway/high-speed level to **ADS Sport** level around 20 seconds after locking. The vehicle is not lowered from raised level after locking. When the engine is started, the previous setting, e.g. **ADS COMF**, is restored.

**!** Always keep in mind the differences in ground clearance and vehicle height when compared to standard vehicles. You could otherwise damage the vehicle.

You will find different values for ground clearance and vehicle height with regard to:

- off-road fording (> page 164)
- the general vehicle dimensions in the "Technical data" section

## ADS (Adaptive Damping System)

### General notes

ADS is continuously electronically controlled. It adapts the damping characteristics to the current operating and driving situation. Damping is controlled separately for each wheel. This increases driving safety and tire comfort.

This depends on:

- your driving style
- the road surface conditions
- the ADS setting
- the vehicle level setting

Your selection remains stored even if you remove the key from the ignition lock.

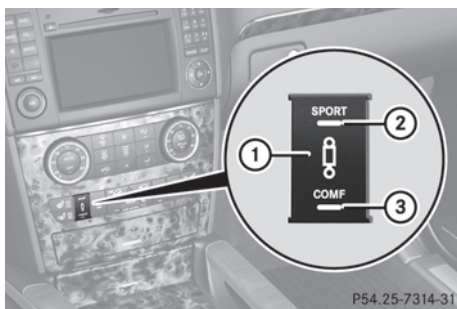

You can choose between the following ADS settings:

- **AUTO** for normal driving situations; indicator lamps ② and ③ are off.
  - **SPORT** for sporty driving; indicator lamp ② is on. In comparison to **AUTO** or **COMF**, the vehicle is 0.6 in (15 mm) lower. In comparison to **AUTO**, AMG vehicles are 0.3 in (8 mm) lower.
  - **COMF** for a more comfortable ride; indicator lamp ③ is on. In comparison to **AUTO**, AMG vehicles are 0.28 in (7 mm) higher.
- ▶ Start the engine.
- ▶ Press button ① repeatedly until the desired setting is selected.

## PARKTRONIC

### Important safety guidelines

#### ⚠ Warning!

The PARKTRONIC is a supplemental system. It is not intended to, nor does it replace, the need for extreme care. The responsibility during parking and other critical maneuvers always remains with the driver.

#### ⚠ Warning!

Make sure no persons or animals are in or near the area in which you are parking/maneuvering. Otherwise, they could be injured.

PARKTRONIC is an electronic parking aid with ultrasonic sensors. It indicates visually and audibly the distance between your vehicle and an object.

PARKTRONIC is activated automatically when you:

- switch on the ignition.
- shift the transmission to position **D**, **R** or **N**.
- release the parking brake.

PARKTRONIC is deactivated at speeds above 11 mph (18 km/h). It is reactivated at lower speeds.

PARKTRONIC monitors the area around your vehicle using six sensors in the front bumper and four sensors in the rear bumper.

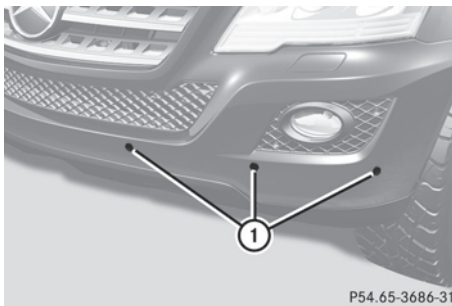

- ① Sensors in the front bumper, left-hand side (example)

## Range of the sensors

The sensors must be free of dirt, ice and slush; otherwise they may not function correctly. Clean the sensors regularly, taking care not to scratch or damage them (▷ page 291).

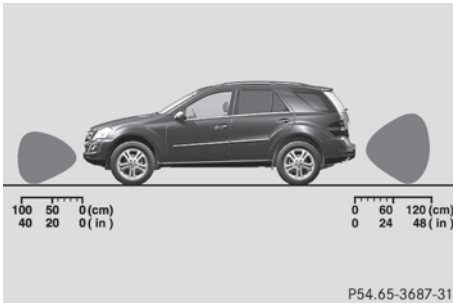

Side view

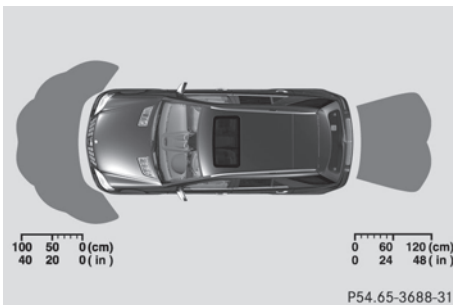

Top view

### Front sensors

Center	Approx. 40 in (100 cm)
Corners	Approx. 24 in (60 cm)

### Rear sensors

Center	Approx. 48 in (120 cm)
Corners	Approx. 32 in (80 cm)

**!** When parking, pay particular attention to objects above or below the sensors, such as flower pots or trailer drawbars. PARKTRONIC does not detect such objects when they are in the immediate vicinity of

the vehicle. You could damage the vehicle or the objects.

Ultrasonic sources such as an automatic car wash, a truck's compressed-air brakes or a pneumatic drill could cause PARKTRONIC to malfunction.

### Minimum distance

Center	Approx. 8 in (20 cm)
Corners	Approx. 6 in (15 cm)

If there is an obstacle within this range, all warning displays light up and a warning tone sounds. If the distance falls below the minimum, the distance may no longer be shown.

### Warning displays

The warning displays show the distance between the sensors and the obstacle. The warning display for the front area is located on the dashboard above the center air vents. The warning display for the rear area is in the roof lamp in the rear compartment.

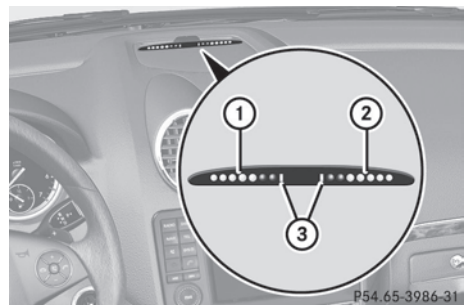

Warning display for the front area

- ① Segments on the left-hand side of the vehicle
- ② Segments on the right-hand side of the vehicle
- ③ Segments showing operational readiness

The warning display for each side of the vehicle is divided into five yellow and two red segments. PARKTRONIC is operational if

yellow segments showing operational readiness ③ light up.

The selected transmission position determines which warning display is active when the engine is running.

Transmission position	Warning display
D	Front area activated
R or N	Rear and front areas activated
P	No areas activated

One or more segments light up as the vehicle approaches an obstacle, depending on the vehicle's distance from the obstacle.

From the:

- sixth segment onwards, you will hear an intermittent warning tone for approximately two seconds.
- seventh segment onwards, you will hear a warning tone for approximately two seconds. This indicates that you have now reached the minimum distance.

### Deactivating/activating PARKTRONIC

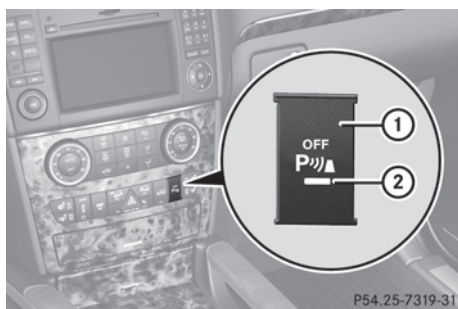

All models except ML 450 HYBRID (example)

- ① To deactivate/activate PARKTRONIC
- ② Indicator lamp

If indicator lamp ② lights up, PARKTRONIC is deactivated.

### Towing a trailer

PARKTRONIC is deactivated for the rear area when you establish an electrical connection between your vehicle and a trailer.

- ❗ Fold in the ball coupling if the trailer tow hitch is not required. PARKTRONIC measures the minimum detection range to an obstacle from the bumper, not the ball coupling.
- ❗ Vehicles with an exterior spare wheel: Remove the detachable ball coupling if the trailer tow hitch is not required. PARKTRONIC measures the minimum detection range to an obstacle from the bumper, not the ball coupling.

## Problems with PARKTRONIC

Problem	Possible causes/consequences and ► Solutions
Only the red segments in the PARKTRONIC warning displays are lit. You also hear a warning tone for approximately two seconds. PARKTRONIC is deactivated after approximately 20 seconds and the indicator lamp in the PARKTRONIC button lights up.	PARKTRONIC has malfunctioned and has switched off. ► If problems persist, have PARKTRONIC checked at a qualified specialist workshop.
Only the red segments in the PARKTRONIC warning displays are lit. PARKTRONIC is deactivated after approximately 20 seconds.	The PARKTRONIC sensors are dirty or there is interference. ► Clean the PARKTRONIC sensors (► page 291). ► Switch the ignition back on.  The problem may be caused by an external source of radio or ultrasound waves. ► See if PARKTRONIC functions in a different location.

### Rear view camera

#### Important safety guidelines

The rear view camera is an optical parking aid. It shows the area behind your vehicle in the COMAND APS display.

#### **Warning!**

Make sure no persons or animals are in or near the area in which you are parking/maneuvering. Otherwise, they could be injured.

The rear view camera is located in the handle strip of the tailgate.

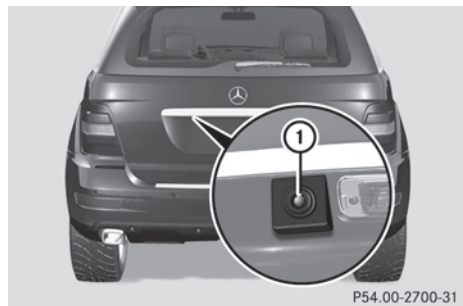

① Rear view camera

#### View through the camera

The area behind the vehicle is displayed as a mirror image, as in the rear-view mirror.

**⚠ Warning!**

The rear view camera is only an aid and may display obstacles

- from a distorted perspective
- inaccurately
- may not display obstacles at all

The rear view camera does not relieve you of the responsibility to be cautious. Take care and pay careful attention. The rear view camera may not show objects which are

- very close to the rear bumper
- under the rear bumper
- above the tailgate handle

You are responsible for safety at all times and must continue to pay attention to the immediate surroundings when parking and maneuvering. This includes the area behind, in front of, and beside the vehicle. Otherwise you could endanger yourself and/or others.

**⚠ Warning!**

The rear view camera either will not function or will not function to its full capability if

- the tailgate is open
- it is raining very hard, snowing or foggy
- it is night or you are parking/maneuvering your vehicle in an area where it is very dark
- the camera is exposed to a very bright white light
- the immediate surroundings are illuminated with fluorescent light (the display may flicker)
- there is a sudden change in temperature, e.g. if you drive into a heated garage from the cold (lens condensation)
- the camera lens is dirty or covered
- the rear of your vehicle is damaged

In this case, have the position and setting of the camera checked by a qualified specialist workshop. Mercedes-Benz recommends that you contact a Mercedes-Benz Center for this purpose.

Do not use the rear view camera in these situations. Otherwise you could injure yourself or others and/or damage property including your vehicle while parking/maneuvering.

**Activating the rear view camera**

- ▶ Make sure that the key is in position **2** in the ignition lock.
- ▶ Make sure that the "rear view camera" function is selected in COMAND APS; see the separate operating instructions for COMAND APS.
- ▶ Engage reverse gear.  
The area behind the vehicle is shown in the COMAND APS display with guide lines.

**Guide lines in the COMAND APS display****⚠ Warning!**

Use of rear view camera can be dangerous if you are color-blind or have impaired color vision.

Only use rear view camera if you can see and distinguish all colored guidelines shown by rear view camera on the COMAND system display.

**⚠ Warning**

Please note that objects that do not touch the ground may appear to be further away than they actually are, for example:

- the bumper of a vehicle parked behind you
- the trailer drawbar
- the ball coupling of a trailer tow hitch
- the rear end of a truck
- a slanted post

In such cases, you should not use the guide lines to judge the distance. You may misjudge the distance, which increases the risk of impacting the objects.

Even if the object you approach is directly on the ground, do not approach the object any closer than the red guide line.

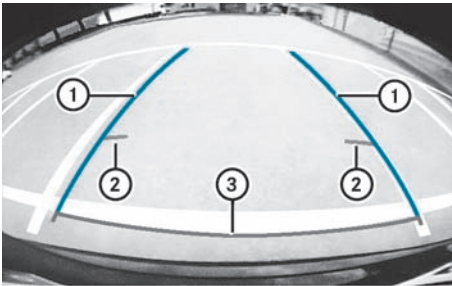

P54.65-3644-31

Guide lines ② and ③ show the approximate distance from the rear of the vehicle. Yellow guide line ② indicates a distance of approximately 3 ft (1 m) and red guide line ③ indicates a distance of approximately 10 in (0.25 m). The distance only applies to objects at ground level. Blue line ① depicts the width required for the vehicle. It is used to align the vehicle with the edge of the road, e.g. the curb.

## Blind Spot Assist

### Important safety guidelines

Blind Spot Assist uses a radar sensor system to monitor the areas on both sides of your vehicle. It is active at speeds above approximately 20 mph (30 km/h). A warning display in the exterior mirrors draws your attention to vehicles in the monitored area. If you then indicate a turn towards that side before changing lane, you will also receive visual and audible collision warnings. For this purpose, Blind Spot Assist uses sensors in the rear bumper.

### Warning

Blind Spot Assist is only an aid designed to assist driving. It may fail to detect some vehicles and is no substitute for attentive driving.

Blind Spot Assist cannot detect road and traffic conditions. It may fail to detect narrow vehicles, such as motorcycles or bicycles, or may only detect them too late.

Monitoring may be affected by dirty sensors, strong spray or poor visibility caused by snow, rain or mist, for example. In this case, vehicles are detected late or not at all.

Always pay attention to traffic conditions and your surroundings. Otherwise, you may fail to recognize dangers in time, cause an accident and injure yourself and others.

### USA only:

This device has been approved by the FCC as a "Vehicular Radar System." The radar sensor is intended for use in an automotive radar system only. Removing, tampering with, or altering the device will void any warranties, and is not permitted by the FCC. Do not tamper with, alter, or use in any non-approved way.

Any unauthorized modification to this device could void the user's authority to operate the equipment.

For Blind Spot Assist to assist you when driving, the radar sensor system must be switched on (> page 217) and operational.

### Monitoring range of the sensors

Blind Spot Assist monitors the area up to 10 ft (3 m) behind your vehicle and directly next to your vehicle as shown in the diagram.

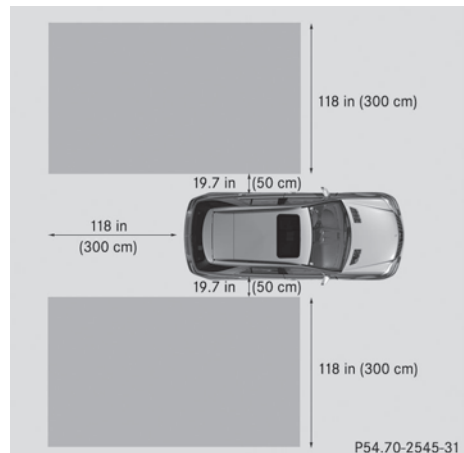

P54.70-2545-31

### Warning

Blind Spot Assist monitors certain areas in the immediate vicinity of your vehicle. Vehicles that approach and drive past at high speeds are not detected. There is no display and no warning.

If the lanes are very wide, it may not be possible to monitor the complete width of the neighboring lane. For this reason, vehicles in the next lane may not be detected, especially if they are driving in a staggered formation. This may be the case if vehicles are driving at that edge of their lane which is furthest away from your vehicle.

Always pay attention to traffic conditions and your surroundings. Otherwise, you may fail to recognize dangers in time, cause an accident and injure yourself and others.

If the lanes are narrow, the system may be unable to distinguish the neighboring lane from the one beyond it. For this reason, the system may indicate vehicles in the farther lane, especially if the vehicles are driving in a staggered formation in different lanes. In particular, this may be the case if the vehicles are driving at that edge of their lane which is nearest your vehicle.

Due to the nature of the system:

- warnings may be issued unnecessarily when driving close to crash barriers or similar solid lane borders.
- the warning may be interrupted when traveling next to long vehicles for extended periods.

The two sensors for Blind Spot Assist are integrated into the sides of the rear bumper. Make sure that the bumper is free of dirt, ice or slush around the sensors. For example, the radar sensors must not be covered by bicycle racks or overhanging loads. In the event of a severe impact or damage to the bumpers, have the function of the radar sensors checked at a qualified specialist workshop, e.g. an authorized Mercedes-Benz Center.

Blind Spot Assist may otherwise not work properly.

### Information and warning display

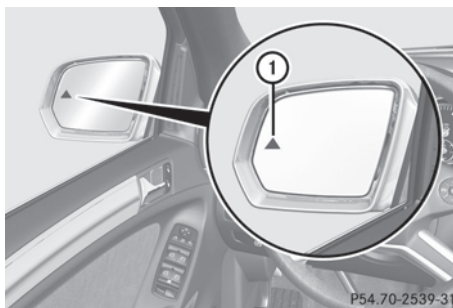

#### ① Yellow indicator lamp/red warning lamp

If Blind Spot Assist is switched on, indicator lamps ① in the exterior mirrors light up yellow up to a speed of 20 mph (30 km/h). At speeds above 20 mph (30 km/h), the indicator lamp goes out and Blind Spot Assist is operational.

If a vehicle is detected within the monitoring range of Blind Spot Assist at speeds above 20 mph (30 km/h), warning lamp ① on the corresponding side lights up red. This warning is always emitted when a vehicle enters the blind spot monitoring range from behind or from the side. When you overtake a vehicle, the warning only occurs if the difference in speed is less than 7 mph (12 km/h).

The yellow indicator lamp goes out if the reverse gear is engaged. In this event, Blind Spot Assist is no longer active.

The brightness of the indicator/warning lamps is adjusted automatically according to the ambient light.

### Warning

Blind Spot Assist is not active at speeds under approximately 20 mph (30 km/h). The indicator lamps in the exterior mirrors are yellow. Vehicles in the monitoring range are then not indicated.

Always pay attention to traffic conditions and your surroundings. Otherwise, you may fail to

recognize dangers in time, cause an accident and injure yourself and others.

### Collision warning

If a vehicle is detected in the monitoring range of Blind Spot Assist and you switch on the turn signal, a double warning tone sounds. Red warning lamp ① flashes. If the turn signal remains on, detected vehicles are indicated by the flashing of red warning lamp ①. There are no further warning tones.

### Switching on Blind Spot Assist

- ▶ Make sure that the radar sensor system (▷ page 217) and Blind Spot Assist (▷ page 219) are activated in the on-board computer.
- ▶ Turn the key to position **2** in the ignition lock.  
Warning lamps ① light up red in the exterior mirrors for approximately 1.5 seconds and then turn yellow.

### Towing a trailer

When you attach a trailer, make sure you have correctly established the electrical connection. This can be accomplished by checking the trailer lighting. In this event, Blind Spot Assist is deactivated. The indicator lamp lights up yellow in the exterior mirrors and the message: Blind Spot Assist Currently Unavailable See Operator's Manual appears in the multifunction display.

- ❗ The indicator lamps in the exterior mirrors can be switched off.  
To do this, you must deactivate Blind Spot Assist when:
  - the key is in position **2** in the ignition lock.
  - the engine is not running.
  - the electrical connection to the trailer has been established.

### Off-road driving systems

#### 4MATIC (permanent four-wheel drive)

4MATIC ensures that all four wheels are permanently driven. Together with ESP® and 4ETS, it improves the traction of your vehicle whenever a drive wheel spins due to insufficient grip.

#### Warning!

If a drive wheel is spinning due to insufficient traction:

- While driving off, apply as little throttle as possible.
- While driving, ease up on the accelerator pedal.
- Adapt your speed and driving style to the prevailing road conditions.

Failure to observe these guidelines could cause the vehicle to skid.

The 4MATIC cannot prevent accidents resulting from excessive speed.

- ❗ Never tow the vehicle with one axle raised. This may damage the transfer case. Damage of this sort is not covered by the Mercedes-Benz Limited Warranty. All wheels must remain either on the ground or be fully raised. Observe the instructions for towing the vehicle with all wheels in full contact with the ground.

- ❗ In wintry driving conditions, the maximum effect of 4MATIC can only be achieved if you use winter tires (M+S tires), with snow chains if necessary.

- ❗ When testing the parking brake, operate the vehicle only briefly (for a maximum of ten seconds) on a brake test dynamometer. When doing this, turn the key to position **0** or **1** in the ignition. Failure to do this can cause damage to the drive train or the brake system.

- ❗ Function or performance tests may only be performed on a 2-axle dynamometer. If you wish to operate the vehicle on such a

dynamometer, please consult an authorized Mercedes-Benz Center beforehand. You could otherwise damage the drive train or the brake system.

Information on "Off-road driving"; see (▷ page 166).

## DSR (Downhill Speed Regulation)

### Important safety guidelines

DSR is an aid to assist you when driving downhill. It keeps the speed of travel at the speed selected on the on-board computer. The steeper the downhill gradient, the greater the DSR braking effect on the vehicle. When driving on flat stretches of road or on an uphill gradient, the DSR braking effect is minimal or non-existent.

The speed is set to 4 mph (6 km/h) at the factory; you can adjust this in the on-board computer (▷ page 219).

#### Warning!

Downhill Speed Regulation (DSR) is a convenience system designed to assist the driver during vehicle operation. The system setting must be appropriate to the topographical and weather conditions encountered, which can change quickly. The driver is responsible for the vehicle speed and for safe brake operation at all times.

Depending on the programmed speed, actual vehicle speed and gradient, switching on DSR while driving can cause the vehicle to slow down rapidly, and you may hear a sound, caused by the activation of the vehicle's brake system through DSR. Sudden and unexpected deceleration can result in loss of vehicle control, causing an accident and/or serious personal injury to you and others. Do not switch on DSR in a situation where rapid deceleration could result in a loss of vehicle control.

DSR controls the set speed when it is active and the automatic transmission is in the **D**,

**R** or **N** position. You can drive at a higher or a lower speed than that set on the on-board computer at any time by accelerating or braking.

#### Warning!

If you depress the accelerator pedal with DSR activated, the vehicle can drive faster than the programmed set speed. You should therefore drive downhill with particular caution as it could lead to an accident and/or serious injury to you or others. Keep in mind that as soon as you remove your foot from the accelerator pedal with DSR switched on, DSR will start regulating the vehicle's speed including use of brakes if required. Depending on the programmed set speed, actual vehicle speed and gradient, DSR can cause the vehicle to slow down rapidly. Sudden and unexpected deceleration can result in loss of vehicle control, causing an accident and/or serious personal injury to you and others.

Information on "Off-road driving"; see (▷ page 166).

## Activating/deactivating DSR

### Activating

You can only activate DSR when driving at speeds below 20 mph (30 km/h).

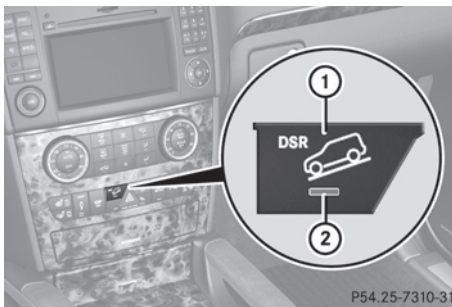

- ▶ Press button ①.
- Indicator lamp ② lights up.

The DSR symbol and a message such as the following appear in the multifunction display:

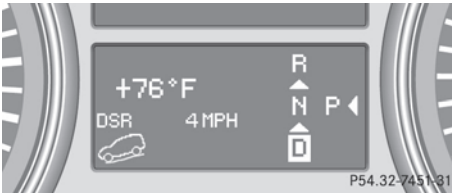

If the vehicle's speed is too high, the DSR symbol and the Max. Speed 20 mph (Canada: 30 km/h) message are shown in the multifunction display.

### Deactivating

- ▶ Press button ①.  
Indicator lamp ② goes out.  
The DSR symbol appears in the multifunction display with the Off message.

DSR switches off automatically when you drive at speeds over 21 mph (Canada: 35 km/h). The DSR symbol appears in the multifunction display with the Off message. You also hear a warning tone.

### Changing the set speed while the vehicle is in motion

When DSR is switched on, you can change the set speed to a value between 3 mph and 10 mph (Canada: between 4 km/h and 18 km/h) while the vehicle is in motion.

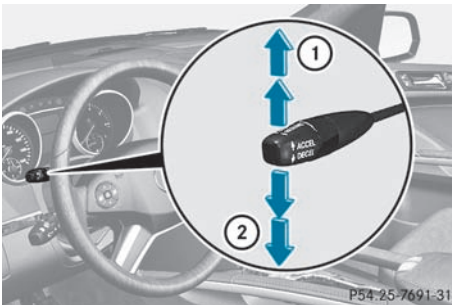

- ▶ To increase or reduce the set speed in 1 mph (Canada: 1 km/h) increments: briefly press the cruise control lever to the

pressure point, up ① for a higher set speed or down ② for a lower set speed. The set value appears in the multifunction display.

- ▶ To increase or reduce the set speed in 5 mph (Canada: 10 km/h) increments: briefly press the cruise control lever past the pressure point, up ① for a higher set speed or down ② for a lower set speed. The set value appears in the multifunction display.

## Off-road drive program

### General notes

The off-road drive program assists you in driving off-road. The engine's performance characteristics and the gearshifting characteristics of the automatic transmission are adapted for this purpose. ABS, ESP® and 4ETS programs especially adapted to off-road driving are also activated.

Do not use the off-road drive program on roads that are snowy or icy or if you have mounted snow chains to your vehicle.

Information on "Off-road driving"; see (▷ page 166).

### AMG vehicles

You can activate and deactivate the off-road drive program using the on-board computer (▷ page 211).

## All models except AMG vehicles

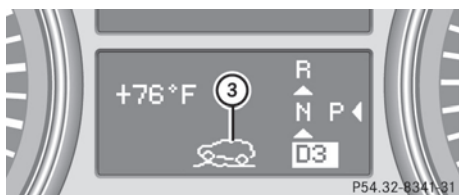
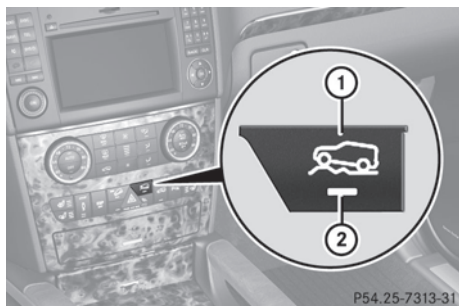

- ▶ **To activate:** press off-road button ①. Indicator lamp ② lights up. Off-road indicator ③ appears in the multifunction display.
- ▶ **To activate:** press off-road button ①. Indicator lamp ② and off-road indicator ③ go out.

## LOW RANGE off-road gear

## General notes

The LOW RANGE off-road gear assists you in driving off-road and when fording. When LOW RANGE is engaged, the engine's performance characteristics and the gearshifting characteristics of the automatic transmission are adapted for this purpose. ABS, ESP® and 4ETS programs especially adapted to off-road driving are also activated.

For information on "Off-road driving", see (▷ page 166). You will find information about driving safety systems in conjunction with LOW RANGE in the "Safety" section (▷ page 65).

## Shift ranges

<b>HIGH RANGE</b>	Road position for all normal driving situations
<b>LOW RANGE</b>	Off-road position for driving off-road and fording The gear ratio between the engine and wheels is only approximately one third of that in the HIGH RANGE road position. The drive torque is correspondingly higher as a result. Do not use LOW RANGE: <ul style="list-style-type: none"> <li>• on slippery road surfaces, e.g. in the case of slush</li> <li>• on snow or ice-covered roads</li> <li>• if you have mounted snow chains to your vehicle</li> </ul>

## ⚠ Warning!

Always wait until the procedure of shifting from HIGH RANGE to LOW RANGE – and from LOW RANGE to HIGH RANGE – has been entirely completed. During this procedure do not turn off the engine or shift the automatic transmission into another gear.

If you do not wait until the shifting procedure has been entirely completed then it might not be correctly performed. The transfer case might be in neutral, thus interrupting the transfer of power between the engine and the drive axle.

The vehicle is then freely movable, even if a gear has been selected, and could unintentionally be set into motion – particularly on up – or downhill grades. This could lead to an accident and cause injury to yourself and others.

Please observe related messages appearing in the multifunction display.

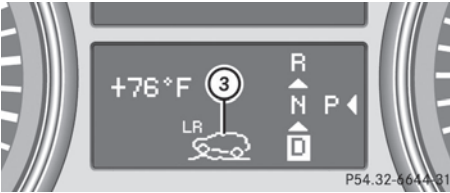
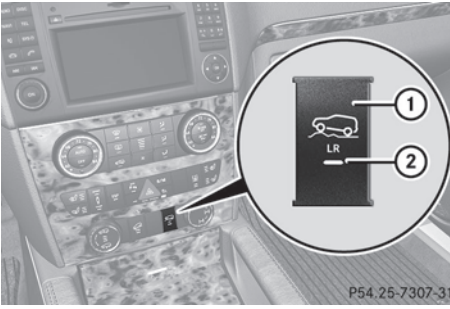

### From HIGH RANGE to LOW RANGE

**!** Only carry out the gear change process if:

- the engine is running
- the transmission is in position **N**
- you are not driving faster than 25 mph (40 km/h)

▶ Press LOW RANGE button ①.  
Indicator lamp ② flashes. LOW RANGE indicator ③ appears in the multifunction display.

When the gear change is complete, indicator lamp ② lights up.

While indicator lamp ② is flashing, you can cancel the gear change by pressing LOW RANGE button ① again.

### From LOW RANGE to HIGH RANGE

**!** Only carry out the gear change process if:

- the engine is running
- the transmission is in position **N**
- you are not driving faster than 43 mph (70 km/h)

▶ Press LOW RANGE button ①.  
Indicator lamp ② flashes.

If the gear change process has taken place, indicator lamp ② and LOW RANGE

indicator ③ in the multifunction display go out.

While indicator lamp ② is flashing, you can cancel the gear change by pressing LOW RANGE button ① again.

### Messages in the multifunction display

If a gear change process has not been successful, the following messages may be displayed in the multifunction display:

Max. Speed 25 Mph (Canada: 40 Km/h): you have been driving faster than 25 mph (40 km/h). Indicator lamp ② also flashes.

▶ Drive more slowly to carry out the gear change process.

Shift briefly into **N**: the transmission is in position **D** and you are driving slower than 25 mph (40 km/h).

▶ Shift the transmission to **N** to complete the gear change process.

Shifting Process Canceled

Reactivate: the shifting process has not been completed.

▶ Ensure that all gear change conditions are fulfilled and carry out the gear change process again.

Stop vehicle, engage parking brake: a warning tone is also heard. The gear change process has not been completed. LOW RANGE is in the neutral position. There is no connection between the engine and the drive wheels.

**!** Do not drive any further, otherwise you could damage the vehicle's drive train.

▶ Stop the vehicle. Take into account the road and traffic conditions when doing this.

▶ Depress the parking brake.

▶ Carry out the gear change process again. If the gear change process has been carried out, the Stop vehicle, engage parking brake message disappears.

## Differential lock

### General notes

**i** Differential locks are available only in vehicles with the Off-Road Pro engineering package.

Your vehicle is equipped with the following:

- A differential lock for the transfer box: this controls the balance between the front and rear axles.
- A differential lock for the rear axle: this controls the balance between the wheels and the rear axle.

Differential locks improve the vehicle's traction. 4ETS (> page 67) controls the balance between the wheels on the front axle. Information on "Off-road driving"; see (> page 166).

### Information about the differential and differential locks

When the vehicle is driving around a curve, the wheels on the outside of the curve have to cover a greater distance and therefore have to turn faster than the wheels on the inside. The differential, a transmission in the drive train, balances these different rotational speeds out, making cornering possible.

The disadvantage of a differential: the wheels with the least grip are driven the hardest. Example: one wheel on a driven axle is on a snow-covered surface and therefore has no traction. This wheel has the most driving force, since the differential distributes most of the force to the wheel with the least resistance. The wheel on the opposite side of this axle, which is on a solid surface and could therefore enable traction, does not have any driving force. 4ETS eliminates this disadvantage and ensures good steerability by braking the spinning wheel automatically and thereby directing more force to the wheel that is on a solid surface and can provide traction.

ESP® and 4ETS are traction systems that are ideally suited to road driving and driving on easily negotiable off-road terrain. The LOW RANGE off-road gear also improves off-road capability.

Difficult off-road conditions require additional measures, such as locking one or more differentials. Your vehicle has two differential locks: one (central) differential lock for the transfer case and one differential lock for the rear axle. Both differential locks can be activated using the selector wheel on the center console. When the (central) differential for the transfer case is locked, the speed of the front wheels is the same as the speed of the rear wheels. When the differential for the rear axle is locked, both of the rear wheels turn at the same speed, independent of their individual torques. Note that activating the differential locks significantly reduces the steerability of the vehicle.

For your safety, the safety of others and to prevent damage to the vehicle, the differential locks must not be activated on paved roads. Note that the differential function is necessary when driving on paved roads and that the differentials must never be locked on paved roads. Otherwise, the vehicle can no longer be steered. The differential locks must therefore only be activated when driving off-road, and then only if activating the other driving systems (4ETS, ESP® and LOW RANGE off-road gear) is no longer sufficient.

### Engaging the differential locks

**!** Drive off slowly when the differential locks are engaged.

Function or performance tests may only be performed on a 2-axle dynamometer. If you wish to operate the vehicle on such a dynamometer, please consult an authorized Mercedes-Benz Center beforehand. You could otherwise damage the drive train or the brake system.

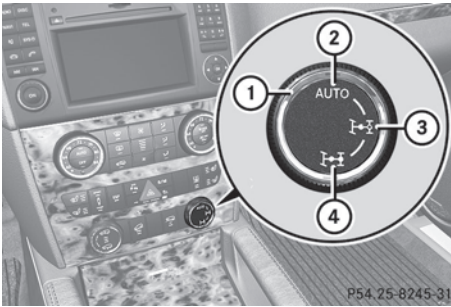

### Automatic mode

Use automatic mode ② for all driving situations, including driving off-road or when fording.

In automatic mode, the differential locks are engaged and disengaged according to driving requirements. This guarantees sufficient traction for most driving situations with unrestricted vehicle steerability.

#### ► Start the engine.

The differential locks are in automatic mode. The indicator lamp in selector wheel ① lights up above symbol for automatic mode ②.

### Engaging manually

#### **Warning!**

Never drive on a paved surface with the center and rear axle differential locks manually engaged. Ability to steer the vehicle is greatly reduced when the differential locks are manually engaged, increasing the risk of an accident.

For safety reasons, the locks are automatically released at a vehicle speed above 31 mph (50 km/h). Nevertheless, you should only manually lock the differential if absolutely necessary because engaged locks will restrict the vehicle drivetrain while cornering and cause the vehicle to chatter. This could cause you to lose control of the vehicle and cause an accident.

**!** The differential locks must not be activated when the vehicle is being towed or while the wheels are spinning.

Only engage the differential locks manually if traction in automatic mode is insufficient.

At speeds of up to 19 mph (30 km/h), you can engage the differential locks manually.

► Start the engine.

► Turn selector wheel ① to desired position ③ or ④.

The indicator lamp in selector wheel ① lights up at the corresponding symbol.

The engaged differential appears in the multifunction display:



⑤ The differential lock for the transfer case is locked.

If you have not previously selected the off-road menu (► page 213) in the on-board computer, the message disappears after about five seconds.

The differential locks are not controlled automatically. The steerability of the vehicle is restricted considerably. Drive carefully and accelerate gently for optimum traction.

**!** If the differential locks are activated manually, the wheels scuff on the road when cornering since the rotation difference between the wheels is no longer balanced out.

You can switch back to automatic mode at any time. For safety reasons, the differential locks disengage automatically at speeds above 31 mph (50 km/h). If you stop the vehicle and switch off the ignition for longer than ten seconds, the differential locks switch back to automatic mode.

**Message in the multifunction display**

Diff. Lock System Overheated -  
Wait briefly.

The differential lock system has overheated and briefly disengaged.

- ▶ Continue driving.  
The differential locks cool off and are soon available once again.

**Towing a trailer****Notes on towing a trailer****Important safety instructions****⚠ Warning!**

Failure to use proper equipment and driving technique can result in a loss of vehicle control when towing a trailer.

Improper towing or failure to follow the instructions in this manual can result in vehicle damage and/or serious personal injury. Follow the guidelines below carefully to assure safe trailer operation.

Contact an authorized Mercedes-Benz Center should you require an explanation of information contained in this manual.

**General information**

- Only install an approved trailer coupling on your vehicle.  
Further information on availability and on installation is available from any authorized Mercedes-Benz Center.
- The bumpers of your vehicle are not suitable for installing detachable trailer couplings.
- Do not install hired trailer couplings or other detachable trailer couplings on the bumpers of your vehicle.
- To reduce the risk of damage to the ball coupling, remove it from the ball coupling recess when not in use.

**Coupling up a trailer****⚠ Warning!**

Vehicles with air suspension program: While you are coupling or decoupling a trailer, make sure nobody locks or unlocks the vehicle and/or opens or closes doors or the tailgate.

The vehicle's level could change and you could endanger yourself and/or others as a result.

Make sure that you do not operate the ADS switch or the vehicle level control system when coupling/decoupling the trailer.

Observe the maximum permissible trailer dimensions (width and length).

Most federal states and all Canadian provinces require by law:

- safety chains between the towing vehicle and the trailer. The chains should be cross-wound under the trailer drawbar. They must be fastened to the vehicle's trailer coupling, not to the bumper or the axle.  
Allow for enough play in the chains to facilitate turning tight corners.
- a separate brake system for certain types of trailer.
- a safety switch for braked trailers. Check the specific legal requirements applicable to your federal state.

If the trailer detaches from the towing vehicle, the safety switch applies the trailer's brakes.

- ❗ Do not connect the trailer's brake system (if featured) to the hydraulic brake system of the towing vehicle, as the latter is equipped with an anti-lock brake system. Doing so will result in a loss of function of the brake systems of both the vehicle and the trailer.

- i The vehicle's wiring harness features a line to the brake indicator lamp.

- ▶ Make sure that the automatic transmission is set to position **P**.
- ▶ Apply the vehicle's parking brake.
- ▶ Start the engine.
- ▶ Vehicles with the AIRMATIC package: select highway level.
- ▶ Vehicles with the adaptive damping system: set ADS to **AUTO** or **COMF**.
- ▶ Switch off the engine.
- ▶ Close all doors and the tailgate.
- ▶ Couple up the trailer.
- ▶ Establish all electrical connections.

**i** Vehicles with the AIRMATIC package: with a trailer attached, the vehicle will always remain at highway level. When coupling up a trailer, please observe the following:

- if highway level has not been set manually, the vehicle will automatically sink to highway level as soon as it reaches a speed of 5 mph (8 km/h).
- high-speed level is not available.

These restrictions apply to all accessories powered through a connection to the trailer power socket of your vehicle, e.g. a bicycle carrier.

### Towing a trailer

There are numerous legal requirements concerning the towing of a trailer, e.g. speed restrictions. Make sure that your vehicle/trailer combination complies with the local requirements not only in your area of residence but also at any location to which you are traveling. The police and local authorities can provide reliable information. Please observe the following when towing a trailer:

- To acquaint yourself with driving with a trailer and with the resulting changes to handling, you should practice cornering,

stopping and reversing in a traffic-free location.

- Before driving, check:
  - the trailer coupling
  - the safety switch for braked trailers
  - the safety chains
  - the electrical connections
  - the lights
  - the wheels
- Adjust the exterior mirrors to provide an unobstructed view of the rear section of the trailer.
- If the trailer features electronically controlled brakes, pull away the vehicle/trailer combination carefully, manually brake using the brake controller, and check the brakes for correct function.
- Secure any objects on the trailer to prevent the cargo from slipping when the vehicle is in motion.
- If you couple up a trailer, regularly check the cargo for secure fastening and make sure that the trailer lamps and (if applicable) the trailer brakes are functioning correctly.
- Bear in mind that the handling will be less stable when towing a trailer than when driving without one. Avoid sudden steering movements.
- The vehicle/trailer combination is heavier, accelerates more slowly, has a decreased gradient climbing capability and a longer braking distance. It is more susceptible to side winds and requires more careful steering.
- If possible, avoid abrupt braking. Depress the brake pedal moderately at first, so that the trailer can activate its own brakes. Then increase the pressure on the brake pedal.
- If the automatic transmission continues to shift back and forth between two gears when driving up or downhill, restrict the shift range. Select shift range **4, 3, 2**, or **1**. A lower gear and lower speed reduce the risk of engine failure.

- On long and steep gradients that are difficult to drive down in shift range **1**, switch to the off-road drive program.
- When driving downhill, shift to a lower gear to utilize the engine's braking effect.  
Avoid continuous brake application as this may overheat the vehicle brakes and, if installed, the trailer brakes.
- If the coolant temperature increases dramatically while the air-conditioning system is switched on, switch off the air-conditioning system.  
Coolant heat can additionally be dissipated by opening the windows and by setting the blower fan and the interior temperature to maximum.
- When overtaking, pay particular attention to the extended length of your vehicle/trailer combination.  
Due to the length of your vehicle/trailer combination, you will have to travel an additional distance beyond the vehicle you are overtaking before returning to the previous lane.

### Decoupling a trailer

#### Warning!

Vehicles with air suspension program: While you are coupling or decoupling a trailer, make sure nobody locks or unlocks the vehicle and/or opens or closes doors or the tailgate.

The vehicle's level could change and you could endanger yourself and/or others as a result.

Make sure that you do not operate the ADS switch or the vehicle level control system when coupling/decoupling the trailer.

- ▶ Make sure that the automatic transmission is set to position **P**.
- ▶ Apply the vehicle's parking brake.
- ▶ Start the engine.
- ▶ Close all doors and the tailgate.
- ▶ Apply the trailer's parking brake.

#### Warning!

Vehicles with air suspension program: As soon as you disconnect the electrical connection between the trailer and the vehicle, the vehicle will lower. To help avoid personal injury, make sure no one is near the wheel housing or underneath the vehicle before the electrical connection is disconnected.

When you decouple the trailer, the vehicle is temporarily raised because the springs are relieved of load. Be especially careful during this process, as you could otherwise injure yourself and/or others. Make sure that any persons remaining in the vehicle do not press the switches for vehicle level control or the ADS.

- ▶ Detach the trailer cable and decouple the trailer.
- ▶ Detach the trailer cable and decouple the trailer.
- ▶ Switch off the engine.

### Permissible trailer load and drawbar noseweight

#### Weight specifications

The Gross Trailer Weight (GTW) is the combined weight of the trailer together with the cargo and equipment loaded on the trailer. Permissible gross weight:

- Vehicles with 4MATIC: 7200 lb (3265 kg)
- Vehicles without 4MATIC: 4630 lb (2100 kg)

The permissible Trailer drawbar Weight Rating (TWR) is the maximum weight permitted on the trailer drawbar:

- Vehicles with 4MATIC: 576 lb (261 kg) limit for Mercedes-Benz-approved trailer couplings
- Vehicles without 4MATIC: 370 lb (168 kg) limit for Mercedes-Benz-approved trailer couplings

## Loading a trailer

---

- When loading a trailer, please note that neither the permissible gross trailer weight nor the permissible Gross Vehicle Weight Rating (GVWR) may be exceeded. The permissible Gross Vehicle Weight Rating (GVWR) is specified on the type plate located on the B-pillar on the driver's side of your vehicle.  
You can find the maximum permissible values on the type plates of your vehicle and the trailer. Always observe the lowest respective value when determining the maximum weight with which you can load the vehicle and the trailer.
  - The drawbar noseweight acting on the ball coupling has to be added to the rear axle weight in order to prevent the permissible Gross Axle Weight Rating (GAWR) from being exceeded. The permissible Gross Vehicle Weight Rating (GVWR) is specified on the type plate located on the B-pillar on the driver's side of your vehicle.
- i** Mercedes-Benz recommends loading the trailer so that the drawbar noseweight remains between 8% and 15% of the permissible gross trailer weight.
- i** The weight of additional accessories, passengers, and cargo reduces the permissible trailer load and drawbar noseweight for your vehicle.

## Checking the vehicle and trailer weight

---

- To check that the weights of the towing vehicle and the trailer comply with the maximum permissible values, have the vehicle/trailer combination (including the driver, passengers, and cargo with a fully laden trailer) weighed on a calibrated weighbridge.
- Check the permissible axle weight of the front and rear axle, the Gross Trailer Weight (GTW), and the drawbar noseweight.

Check the permissible axle weight of the front and rear axle, the Gross Trailer Weight (GTW), and the drawbar noseweight.

### Trailer power supply

The trailer power socket of your vehicle is designed for connecting the 7-pin connector supplied as part of the Mercedes-Benz-approved trailer coupling.

- i** Depending on your trailer, you may need an adapter to connect your trailer to the vehicle.

Further information is available from any authorized Mercedes-Benz Center.



Vehicle equipment .....	204
Important safety guidelines .....	204
Displays and operation .....	204
Menus and submenus .....	207
Display messages .....	222
Warning and indicator lamps in the instrument cluster .....	247

## Vehicle equipment

- i** This manual describes all the standard and optional equipment of your vehicle which was available at the time of purchase. Country-specific differences are possible. Bear in mind that your vehicle may not feature all functions described here. This also refers to safety-related systems and functions.

## Important safety guidelines

You will find an illustration of the instrument cluster in the "At a glance" section (> page 28).

### Warning

A driver's attention to the road and traffic conditions must always be his/her primary focus when driving.

For your safety and the safety of others, selecting features through the multifunction steering wheel should only be done by the driver when traffic and road conditions permit it to be done safely.

Bear in mind that at a speed of just 30 mph (approximately 50 km/h), your vehicle is covering a distance of 44 feet (approximately 14 m) every second.

### Warning!

No messages will be displayed if either the instrument cluster or the multifunction display is inoperative.

As a result, you will not be able to see information about your driving conditions, such as

- speed
- outside temperature
- warning/indicator lamps
- malfunction/warning messages
- failure of any systems

Driving characteristics may be impaired.

If you must continue to drive, do so with added caution. Contact an authorized Mercedes-Benz Center as soon as possible.

### Warning!

HYBRID vehicles: It is imperative that you read the HYBRID Supplemental Operating Instructions included in your vehicle literature portfolio. You may otherwise not receive all necessary safety information and warning for the operation of your vehicle.

### Warning

Malfunction and warning messages are only indicated for certain systems and are intentionally not very detailed. The malfunction and warning messages are simply a reminder with respect to the operation of certain systems. They do not replace the owner's and/or driver's responsibility to maintain the vehicle's operating safety. Have all required maintenance and safety checks performed on the vehicle. Bring the vehicle to an authorized Mercedes-Benz Center to address the malfunction and warning messages.

## Displays and operation

### Tachometer

The red band in the tachometer indicates the engine's overrevving range.

- !** Do not drive in the overrevving range, as this could damage the engine.

The fuel supply is interrupted to protect the engine when the red band is reached.

### Outside temperature display

The outside temperature display is in the multifunction display.

**Warning!**

The outside temperature indicator is not designed to serve as an ice-warning device and is therefore unsuitable for that purpose. Indicated temperatures just above the freezing point do not guarantee that the road surface is free of ice. The road may still be icy, especially in wooded areas or on bridges.

Changes in the outside temperature are displayed after a short delay.









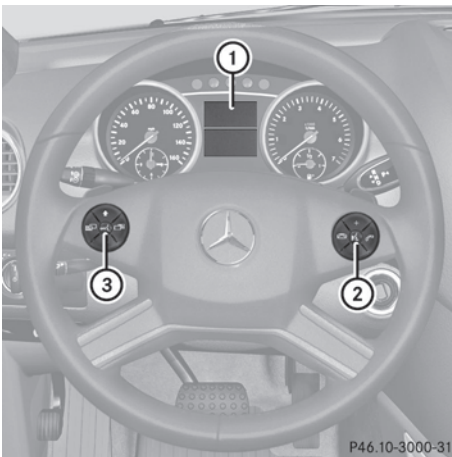

**Speedometer with segments**

The segments in the speedometer indicate which speed range is available. DISTRONIC mode: One or two segments around the stored speed light up.

**Operating the on-board computer**

The on-board computer is activated as soon as you turn the SmartKey to position **1** in the ignition lock. You can control the multifunction display and the settings in the on-board computer using the buttons on the multifunction steering wheel.



①	Multifunction display
②	 Makes/accepts or rejects/ends a call  Selects submenus in the Settings menu  Changes values Adjusts the volume Operates RACETIMER in AMG vehicles  Switches on the Voice Control System; see the separate operating instructions
③	 Selects a menu: scrolls back and forth  Switches off the Voice Control System; see the separate operating instructions
	 <b>Press briefly:</b>  Scrolls back and forth within a menu In the <b>Audio</b> menu: selects a stored station, an audio track or a video scene In the <b>Telephone</b> menu: switches to the phone book and selects a name or a telephone number
	 <b>Press and hold:</b>  In the <b>Audio</b> menu: selects the previous/next station or selects an audio track using rapid scrolling In the <b>Telephone</b> menu: starts rapid scrolling through the phone book

P46.10-3000-31

### Multifunction display

To activate the multifunction display:

- switch on the ignition.
- switch on the lights.
- open the driver's door.
- press the **R** reset button in the instrument cluster.

Values and settings as well as display messages are shown in the multifunction display.

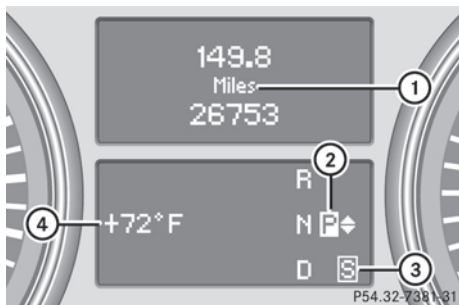

- ① Display area for menus or submenus
- ② Gear indicator
- ③ Transmission mode display
- ④ Status bar with outside temperature or speed (▷ page 214)

Further information on the gear indicator (▷ page 145).

## Menus and submenus

### Menu overview

The number of menus shown depends on the optional equipment in the vehicle.

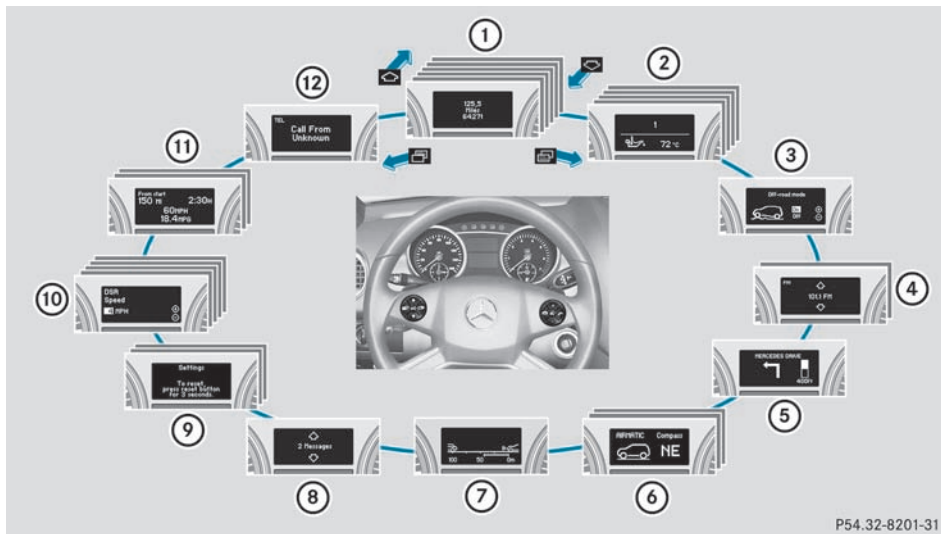

P54.32-8201-31

	Function
①	<b>Standard display</b> menu (▷ page 208) <ul style="list-style-type: none"> <li>• tire pressure loss warning system (Canada only) (▷ page 329)</li> <li>• tire pressure monitor (USA only) (▷ page 331)</li> <li>• ASSYST PLUS service interval display (▷ page 287)</li> </ul>
②	<b>AMG</b> menu in AMG vehicles (▷ page 209)
③	<b>Offroad mode</b> menu (▷ page 211)
④	<b>Audio</b> menu (▷ page 211)
⑤	<b>Navigation</b> menu (▷ page 212)
⑥	<b>Offroad</b> menu (▷ page 213) <ul style="list-style-type: none"> <li>• level control (▷ page 181)</li> <li>• compass display (▷ page 279)</li> <li>• differential locks (status indicator) (▷ page 196)</li> </ul>
⑦	<b>DISTRONIC</b> menu (▷ page 173)
⑧	<b>Message memory</b> <sup>29</sup> menu (▷ page 222)
⑨	<b>Settings</b> menu (▷ page 213)

<sup>29</sup> The menu is only visible when there is a display message.

## Function

- ⑩ **Additional functions** menu (▷ page 219)
- ⑪ **Trip computer** menu (▷ page 219)
- ⑫ **Telephone** menu (▷ page 220)

## Standard display menu

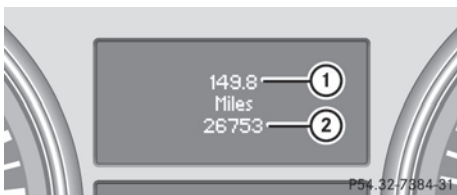

### Standard display

- ▶ Press  or  on the steering wheel to select the standard display.



Standard display

- ① Trip odometer
- ② Odometer

You can select the following functions in the **Standard display** menu by pressing  or :

- tire pressure loss warning system (▷ page 329) (Canada only)
- tire pressure monitor (▷ page 331) (USA only)
- coolant temperature (▷ page 208)
- digital speedometer or outside temperature (▷ page 208)
- ASSYST PLUS service interval display (▷ page 287)
- ▶ **To reset the trip odometer:** press and hold the  reset button in the instrument cluster until the trip odometer is reset.

### Displaying the coolant temperature





#### **Warning**

Driving when your engine is overheated can cause some fluids which may have leaked into

the engine compartment to catch fire. You could be seriously burned.

Steam from an overheated engine can cause serious burns which can occur just by opening the engine hood. Stay away from the engine if you see or hear steam coming from it.

Stop the vehicle in a safe location away from other traffic. Turn off the engine, get out of the vehicle and do not stand near the vehicle until the engine has cooled down.

- ▶ Press  or  on the steering wheel to select the standard display.
- ▶ Press the  or  button to select the coolant temperature.

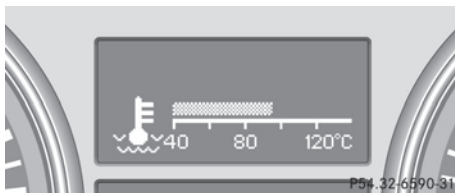





Under normal driving conditions, with the correct anti-corrosion and antifreeze additive concentration, the reading may rise to 248 °F(120 °C).

- ❗ If the coolant temperature exceeds 248 °F(120 °C) do not continue driving. The engine will otherwise be damaged.

### Displaying the digital speedometer or outside temperature

If you have selected the digital speedometer for the status line (▷ page 214), the outside temperature will be displayed here.

- ▶ Press  or  on the steering wheel to select the standard display.
- ▶ Press the  or  button to select digital speedometer or the outside temperature.



Digital speedometer

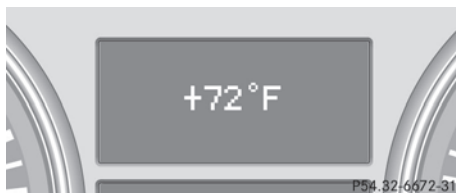

Outside temperature

### AMG menu in AMG vehicles

#### AMG displays

- ▶ Press  or  on the steering wheel to select the **AMG** menu.

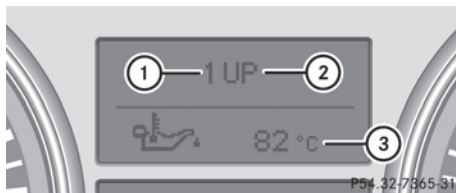



- ① Gear indicator
- ② Upshift instruction
- ③ Engine oil temperature

If the engine reaches the overrevving range in the manual gearshift program, the menu is displayed in red. You will also see shift up instruction ②. Shift up instruction ② overrides other messages in the multifunction display until you have shifted up.

When the engine temperature is below 80 °C, the oil temperature gauge flashes. Avoid driving at full engine output during this time.

#### Displaying the on-board voltage

- ▶ Press  or  on the steering wheel to select the **AMG** menu.
- ▶ Press the  button repeatedly until the on-board voltage is shown.



- ① Gear indicator
- ② On-board voltage



### RACETIMER



#### Displaying and starting RACETIMER

##### Warning

The RACETIMER feature is only for use on roads and in conditions where high speed driving is permitted. Racing on public roads is prohibited under all circumstances. The driver is and must always remain responsible for following posted speed limits.

You can use the RACETIMER to store lap times.

When RACETIMER is displayed, you cannot adjust the volume using the  and  buttons on the steering wheel.

- ▶ Press  or  on the steering wheel to select the **AMG** menu.
- ▶ Press the  button repeatedly until the RACETIMER is shown.



- ① Gear indicator
- ② RACETIMER
- ③ Lap

You can start the RACETIMER when the engine is running or if the SmartKey is in position **2** in the ignition lock.

- ▶ **To start:** press the button to start the RACETIMER.
- ▶ **To display the intermediate time:** press to show the intermediate time. The intermediate time is displayed for five seconds.
- ▶ **To stop:** press the button to stop the RACETIMER.

The RACETIMER interrupts timing when you stop the vehicle and turn the SmartKey to position **1** in the ignition lock. When you turn the SmartKey to position **2** or **3** and then press the button, timing is continued.

### Storing the lap time and starting a new lap

It is possible to store a maximum of nine laps.

- ▶ Press the button on the steering wheel to show the intermediate time during timing. The intermediate time is displayed for five seconds.
- ▶ Press the button again within five seconds. The displayed intermediate time is stored as a lap time. Timing starts for a new lap. The new lap is timed from when the intermediate time is called up.



- ① Gear indicator
- ② RACETIMER
- ③ Fastest lap time (best lap)
- ④ Lap

### Resetting the current lap

- ▶ Press the button on the steering wheel to stop the RACETIMER.
- ▶ Press to reset the lap time to "0".

### Deleting all laps

If you switch off the engine, the RACETIMER is reset to "0" after 30 seconds. All laps are deleted.

You cannot delete individual stored laps.

- ▶ Press the button on the steering wheel to stop the RACETIMER.
- ▶ Press the reset button on the instrument cluster twice.
- ▶ Press the button to start the RACETIMER. All laps are deleted.

### Overall evaluation

This function is shown if you have stored at least one lap and stopped the RACETIMER.

- ▶ Press or on the steering wheel to select the **AMG** menu.
- ▶ Press the button repeatedly until the overall evaluation is shown.

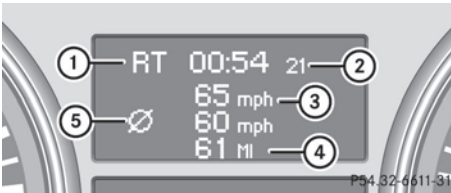

- ① RACETIMER overall evaluation
- ② Total time driven
- ③ Top speed
- ④ Distance covered
- ⑤ Average speed

### Lap evaluation

This function is only available if you have stored at least two laps and have stopped the RACETIMER.

- ▶ Press or on the steering wheel to select the **AMG** menu.
- ▶ Press the button repeatedly until the lap evaluation is shown. Each lap is shown in a separate submenu. The fastest lap is indicated by flashing symbol ①.

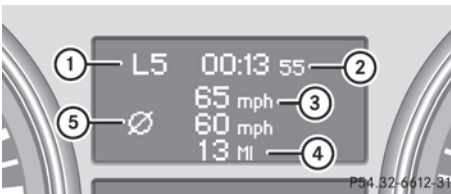

- ① Lap
- ② Lap time
- ③ Top speed during lap
- ④ Lap length
- ⑤ Average lap speed
- ▶ Press the or button to select a different lap evaluation.

### Off-road mode menu in AMG vehicles

In the Off-road Mode menu you can switch the off-road drive program (▷ page 193) on or off.

- ▶ Press the or button on the steering wheel to select the Off-road Mode menu.
- ▶ Press the or button to switch Off-road Mode on or off.

- ❗ The setting will remain stored after you switch off the engine.

If the off-road drive program is switched on, you will see off-road display ① in the multifunction display.

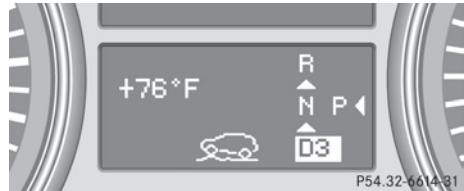

- ① Off-road display

### Audio menu

#### Selecting a radio station

- ❗ SIRIUS XM satellite radio acts like a normal radio.

For more information on satellite radio operation, see the separate operating instructions.

You can only change the waveband and store new stations using COMAND APS.

- ▶ Switch on COMAND APS and select Radio (see the separate operating instructions).
- ▶ Press or on the steering wheel to select the **Audio** menu.

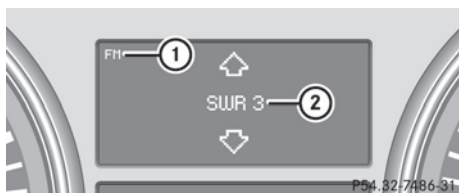

- ① Waveband<sup>30</sup>
- ② Current channel

- ▶ **To select a stored channel:** briefly press the or button.
- ▶ **To select a channel from the channel list:** press and briefly hold the or button.
- ▶ **To select a station using the station search<sup>31</sup>:** press and briefly hold the or button.

### Audio player or audio media operation

Audio data from various audio devices or media can be played, depending on the equipment installed in the vehicle.

- ▶ Switch on COMAND APS and select the audio player or medium (see the separate operating instructions).
- ▶ Press or on the steering wheel to select the **Audio** menu.



- CD changer display (example)
- ① Current CD (for CD/DVD changer)
- ② Current track

- ▶ **To select the next/previous track:** briefly press the or button.
- ▶ **To select a track from the track list (rapid scrolling):** press and briefly hold the or button.

The current track will not be displayed in audio AUX mode (**A**uxiliary audio mode: external audio source connected).

### Video DVD operation

- ▶ Switch on COMAND APS and select video DVD (see the separate operating instructions).
- ▶ Press or on the steering wheel to select the **Audio** menu.

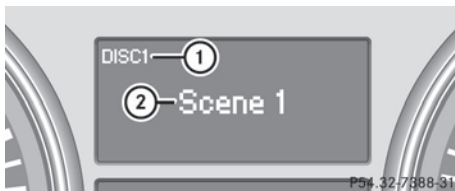

DVD changer display (example)

- ① Current DVD (for DVD changer)
- ② Current scene
- ▶ Press the or button to select a scene.

### Navigation menu

#### Displaying navigation instructions

In the **Navigation** menu, the instructions from the navigation system appear in the multifunction display. For more information, see the separate operating instructions.

- ▶ Switch on COMAND APS (see the separate operating instructions).
- ▶ Press or on the steering wheel to select the **Navigation** menu.

<sup>30</sup> When current channel ② has been stored, the memory position will also be displayed.

<sup>31</sup> Only if no station list is received.

### Route guidance inactive

The direction of travel appears in the multifunction display. If the name of the street is part of the navigation system data, this will also be displayed.



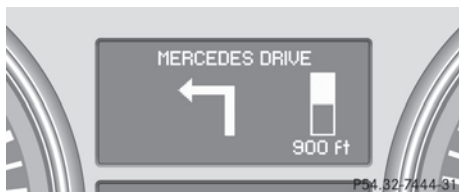

### Route guidance active

The multifunction display shows navigation instructions, for example:



### Off-road menu

Depending on your vehicle's optional equipment, you can set the following current settings to be shown in the **Off-road** menu:

- level control (▷ page 181)
  - compass (▷ page 279)
  - differential locks (▷ page 196)
- i** Large buildings, power cables or powerful transmission masts as well as metallic objects on or in the vehicle may interfere with the compass display.
- ▶ Press  or  on the steering wheel to select the **Offroad** menu.

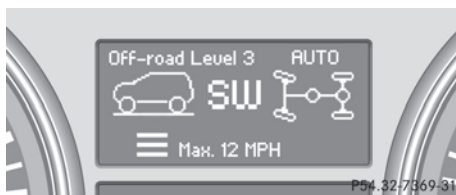

Example display for vehicles with the Off-Road Pro engineering package

### Settings menu

#### Introduction

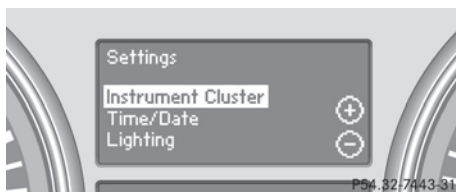





The Settings menu allows you to:

- Restoring the factory settings
- Changing the instrument cluster settings
- Changing the time/date settings<sup>32</sup>
- Changing the lighting settings
- Changing the vehicle settings
- Changing the convenience settings

#### Resetting to factory settings

For safety reasons, the Daytime Running Lamps function in the Lighting submenu is only reset if the vehicle is stationary.



- ▶ Press  or  on the steering wheel to select the Settings menu.
- ▶ Press and hold the  reset button on the instrument cluster for approximately three seconds.

A prompt appears in the multifunction display asking you to confirm by pressing the  reset button again.

<sup>32</sup> This function is not available in vehicles with the navigation module.

- ▶ Press the **R** reset button again.  
The settings of most functions are restored to the factory settings.

or

- ▶ If you want to retain the settings, do not press the **R** reset button a second time. After approximately five seconds, the Settings menu appears again.
- ▶ Press  or  to select a different menu.











## Instrument cluster

### Selecting the unit of measurement for distance











This function is only available in Canada.

The Display Unit Speedometer/Odometer function allows you to choose whether certain displays appear in km/h or mph.

The selected unit of measurement for distance applies to:











- the analog speedometer
- the odometer and the trip odometer
- the trip computer
- the navigation instruction in the **Navigation** menu
- DISTRONIC
- ▶ Press  or  on the steering wheel to select the Settings menu.
- ▶ Press  to call up the selection of submenu.
- ▶ Press  or  to select the Instrument Cluster submenu.
- ▶ Press  to select Display Unit Speedometer/Odometer.
- ▶ Press the  or  button to select Km or Miles as the unit of measurement for distance.
- ▶ Press the ,  or  button to select a different display.

### Selecting the unit of distance for the digital speedometer







- ▶ Press  or  on the steering wheel to select the Settings menu.
- ▶ Press  to call up the selection of submenu.
- ▶ Press the  or  button to select the Instrument Cluster submenu.
- ▶ Press the  button to display Display Unit Digital speedometer.
- ▶ Press the  or  button to select Km or Miles as the unit of measurement for distance.
- ▶ Press the ,  or  button to select a different display.





### Selecting the language

The Language function allows you to select the language for the instrument cluster.

- ▶ Press  or  on the steering wheel to select the Settings menu.
- ▶ Press  to call up the selection of submenu.
- ▶ Press  or  to select the Instrument Cluster submenu.
- ▶ Press the  button to select Language.
- ▶ Press the  or  button to select the desired language.
- ▶ Press the ,  or  button to select a different display.

### Selecting the status line display







- ▶ Press  or  on the steering wheel to select the Settings menu.
- ▶ Press  to call up the selection of submenu.
- ▶ Press  or  to select the Instrument Cluster submenu.
- ▶ Press  to select Status Line Display.

- ▶ Press  or  to select the display in the status line: speed (Speed) or outside temperature (Outside Temperature). The selected display now appears constantly in the lower multifunction display. When you scroll through the **Standard display** menu (> page 208), you will see the display you have not selected.
- ▶ Press the ,  or  button to select a different display.







## Time/date

Only vehicles without the navigation module have this submenu. To set the time and date on vehicles without the navigation module, see the separate operating instructions.

In the Time / Date submenu, you can set the time and date.

- ▶ Press  or  on the steering wheel to select the Settings menu.
- ▶ Press  to call up the selection of submenu.
- ▶ Press the  or  button to select the Time / Date submenu.
- ▶ **To set the clock:** press  on the steering wheel to select Clock Set hour or Clock Set Minute(s).

or

- ▶ **To set the date:** press  to select Date Set day, Date Set Month or Date Set Year.
- ▶ Press  or  to set a value.
- ▶ Press the ,  or  button to select a different display.











## Lighting

### Switching the daytime running lamps on/off

This function is not available in Canada.

If you have activated the daytime running lamps function and the light switch is in the  or **AUTO** position, the daytime running lamps are switched on automatically when the engine is running.

In the dark, the following also light up:

- the low-beam headlamps
  - the parking lamps
  - the tail lamps
  - the license plate lamp
  - the side marker lamps
- ▶ Press  or  on the steering wheel to select the Settings menu.
  - ▶ Press  to call up the selection of submenu.
  - ▶ Press the  or  button to select the Lighting submenu.
  - ▶ Press  to select Daytime Running Lamps.
  - ▶ Press  or  to set daytime running lamps to On or Off.
  - ▶ Press the ,  or  button to select a different display.

### Switching the surround lighting on/off











If you activate the surround lighting function and the light switch is set to **AUTO**, the following will light up if it is dark and you unlock the vehicle using the SmartKey:

- the parking lamps
- the license plate lamp
- the tail lamps
- the fog lamps<sup>33</sup>
- the low-beam headlamps<sup>34</sup>
- the side marker lamps

The surround lighting switches off automatically after 40 seconds or when the driver's door is opened.











<sup>33</sup> Only for vehicles with front fog lamps.

<sup>34</sup> Only for vehicles without front fog lamps.

- ▶ Press  or  on the steering wheel to select the Settings menu.
- ▶ Press  to call up the selection of submenu.
- ▶ Press the  or  button to select the Lighting submenu.
- ▶ Press  to select Surround Lighting Function.
- ▶ Press the  or  button to activate or deactivate the Surround Lighting function.
- ▶ When leaving the vehicle, turn the light switch to position **AUTO**. The surround lighting is activated.
- ▶ Press the ,  or  button to select a different display.

### Setting the ambient lighting

This function is only available in the "Grand Edition" model.











- ▶ Press  or  on the steering wheel to select the Settings menu.
- ▶ Press  to call up the selection of submenu.
- ▶ Press the  or  button to select the Lighting submenu.
- ▶ Press the  button to select Ambient Light.
- ▶ Press  or  to adjust the brightness to any level from Level 0 (off) to Level 5 (bright).
- ▶ Press the ,  or  button to select a different display.

### Activating/deactivating the exterior lighting delayed switch-off

When you activate the Headlamp Delayed Shut-off function and the light switch is set to **AUTO**, the exterior lighting remains on for another 15 seconds after closing the doors when it is dark.

If the engine is switched off and then none of the doors are opened, or if an open door is not closed, the exterior lighting goes out after 60 seconds.

If you have activated the delayed switch-off function, the light switch is set to **AUTO** and you switch off the engine, the following remain lit:

- the parking lamps
  - the license plate lamp
  - the tail lamps
  - the fog lamps<sup>35</sup>
  - the low-beam headlamps<sup>36</sup>
  - the side marker lamps
- ▶ Press  or  on the steering wheel to select the Settings menu.
  - ▶ Press  to call up the selection of submenu.
  - ▶ Press the  or  button to select the Lighting submenu.
  - ▶ Press the  button to select Headlamp Delayed Shut-off.
  - ▶ Press the  or  button to activate or deactivate the Headlamp Delayed Shut-off function.
  - ▶ Before switching off the engine, turn the light switch to position **AUTO**. The exterior lighting delayed shut-off is activated.
  - ▶ Press the ,  or  button to select a different display.

To deactivate the delayed shut-off temporarily:

- ▶ Before leaving the vehicle, turn the SmartKey to position **0** in the ignition lock.
- ▶ Turn the SmartKey to position **2** in the ignition lock and back to position **0**. The delayed shut-off is deactivated.











The delayed shut-off is reactivated the next time you start the engine.

<sup>35</sup> Only for vehicles with front fog lamps.

<sup>36</sup> Only for vehicles without front fog lamps.

### Activating/deactivating the interior lighting delayed switch-off











When you activate the Interior Lighting Delayed Shut-off function and remove the SmartKey from the ignition lock, the interior lighting remains on for 10 seconds.

- ▶ Press  or  on the steering wheel to select the Settings menu.
- ▶ Press  to call up the selection of submenu.
- ▶ Press the  or  button to select the Lighting submenu.
- ▶ Press the  button to select Interior Lighting Delayed Shut-off.
- ▶ Press the  or  button to activate or deactivate the Interior Lighting Delayed Shut-off function.
- ▶ Press the ,  or  button to select a different display.

## Vehicle

### Activating/deactivating the automatic locking feature

When you activate the Automatic Door Locking function, your vehicle will be centrally locked above a speed of approximately 9 mph (15 km/h).

- i** Further information on the automatic locking feature (▷ page 79).
- ▶ Press  or  on the steering wheel to select the Settings menu.
- ▶ Press  to call up the selection of submenu.
- ▶ Press the  or  button to select the Vehicle submenu.
- ▶ Press  to select Automatic Door Locking.
- ▶ Press  or  to switch Automatic Door Locking on or off.
- ▶ Press the ,  or  button to select a different display.

### Activating/deactivating the radar sensor system

If the radar sensor system is switched off, Blind Spot Assist (▷ page 189) is deactivated.











- i** USA only: This device has been approved by the FCC as a “Vehicular Radar System”. The radar sensor is intended for use in an automotive radar system only. Removal, tampering, or altering of the device will void any warranties, and is not permitted by the FCC. Do not tamper with, alter, or use in any non-approved way.  
Any unauthorized modification to this device could void the user’s authority to operate the equipment.

- i** Canada only:

This device complies with RSS-210 of Industry Canada. Operation is subject to the following two conditions:

1. This device may not cause interference, and
2. This device must accept any interference received, including interference that may cause undesired operation of the device.

Any unauthorized modification to this device could void the user’s authority to operate the equipment.

- ▶ Press  or  on the steering wheel to select the Settings menu.
- ▶ Press  to call up the selection of submenu.
- ▶ Press the  or  button to select the Vehicle submenu.
- ▶ Press the  button to select Radar Sensor (See Operator's Manual).
- ▶ Press the  or  button to activate or deactivate the Radar Sensor (See Operator's Manual).
- ▶ Press the ,  or  button to select a different display.

## Convenience

### Activating/deactivating the EASY-ENTRY/EXIT feature

You can use the Easy-entry Function to activate or deactivate the easy-entry/exit feature (▷ page 100).











#### Warning

You must make sure no one can become trapped or injured by the moving steering wheel when the easy-entry/exit feature is activated.

To stop steering wheel movement do one of the following:











- Move steering wheel adjustment stalk.
- Press one of the memory position buttons.
- Press memory button **M**.

Do not leave children unattended in the vehicle, or with access to an unlocked vehicle. Children could open the driver's door and unintentionally activate the easy-entry/exit feature, which could result in an accident and/or serious personal injury.

- ▶ Press  or  on the steering wheel to select the Settings menu.
- ▶ Press  to call up the selection of submenu.
- ▶ Press the  or  button to select the Comfort submenu.
- ▶ Press  to select the Easy-entry Function function.
- ▶ Press the  or  to activate or deactivate the Easy-entry Function function.
- ▶ Press the ,  or  button to select a different display.

### Switching the belt adjustment on/off











Further information on belt adjustment (▷ page 56).

- ▶ Press  or  on the steering wheel to select the Settings menu.
- ▶ Press  to call up the selection of submenu.
- ▶ Press the  or  button to select the Comfort submenu.
- ▶ Press the  button to select Belt Adjustment.
- ▶ Press the  or  button to activate or deactivate Belt Adjustment.
- ▶ Press the ,  or  button to select a different display.

### Switching the fold in mirrors when locking function on/off

When you activate the Fold In Mirrors When Locking function, the exterior mirrors are folded in when the vehicle is locked. When you switch on the ignition, the exterior mirrors fold out again.







If you have switched the function on and you fold the exterior mirrors in using the button on the door (▷ page 102), they will not fold out automatically. The exterior mirrors can then only be folded out using the button on the door.

- ▶ Press  or  on the steering wheel to select the Settings menu.
- ▶ Press  to call up the selection of submenu.
- ▶ Press the  or  button to select the Comfort submenu.
- ▶ Press  to select Fold In Mirrors When Locking.
- ▶ Press  or  to activate/deactivate the Fold In Mirrors When Locking function.
- ▶ Press the ,  or  button to select a different display.

## Additional functions menu

### Switching the distance warning function on/off

This function is only available with DISTRONIC.









- ▶ Press  or  on the steering wheel to select the **Additional functions** menu.
- ▶ Press the  or  button to select the Distance Warning function.
- ▶ Press the  or  button to activate or deactivate the Distance Warning system.

When the distance warning function (▷ page 69) is activated, the  symbol is shown in the lower multifunction display.

- ▶ Press the ,  or  button to select a different display.









### Activating/deactivating Blind Spot Assist

Further information about Blind Spot Assist (▷ page 189).

- ▶ Press  or  on the steering wheel to select the **Additional functions** menu.
- ▶ Press the  or  button to select the Blind Spot Assist function.
- ▶ Press  or  to switch the Blind Spot Assist function on or off.
- ▶ Press the ,  or  button to select a different display.

### Setting DSR





The DSR Speed function allows you to set the threshold speed (vehicle speed for driving downhill) of the DSR (▷ page 192) to a value between 3 mph (Canada: 4 km/h) and 10 mph (Canada: 18 km/h). The adjustment is carried out in increments of 1 mph (Canada: 2 km/h).

- ▶ Press  or  on the steering wheel to select the **Additional functions** menu.
- ▶ Press the  or  button to select the DSR Speed function.
- ▶ Press the  or  button to set the desired threshold speed.
- ▶ Press the ,  or  button to select a different display.

## Trip computer menu

### Trip computer "From start" or "From reset"

The values in the From Start submenu refer to the start of your journey, while those in the From Reset submenu refer to the last time you reset this submenu.

- ▶ Press  or  on the steering wheel to select the **trip computer** menu.
- ▶ Press  or  to select From Start or From Reset.

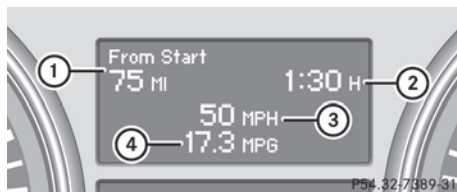

Trip computer "After start" (example)

- ① Distance
- ② Time
- ③ Average speed
- ④ Average fuel consumption





The From Start trip computer is reset automatically when

- the ignition has been switched off for more than 4 hours.
- 999 hours have been exceeded.
- 9999 miles have been exceeded.





The From Reset trip computer is automatically reset if the trip exceeds 9999 hours or 99,999 miles.

You can select Km or Miles as the unit of measurement for distance (▷ page 214).





### Resetting values

- ▶ Press  or  on the steering wheel to select the **trip computer** menu.
- ▶ Press  or  to select the function that you wish to reset.
- ▶ Press and hold the (R) reset button on the instrument cluster until the values have reverted to "0".

### Calling up the range

- ▶ Press  or  on the steering wheel to select the **trip computer** menu.
- ▶ Press  or  to select Range: . The multifunction display shows the estimated range of the vehicle, based on the current driving style and the fuel level. If there is only a small amount of fuel remaining in the fuel tank, a vehicle refueling  appears instead of the range.

### Displaying the current fuel consumption

- ▶ Press  or  on the steering wheel to select the **trip computer** menu.
- ▶ Press  or  to select Consumption. The current fuel consumption is displayed<sup>37</sup>.

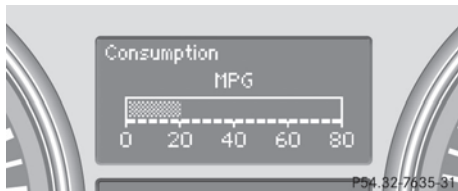



## Telephone menu

### Introduction

You can establish a Bluetooth® wireless connection to COMAND APS (see the separate operating instructions).

#### Warning

A driver's attention to the road must always be his/her primary focus when driving. For your safety and the safety of others, we recommend that you pull over to a safe location and stop before placing or taking a telephone call. If you choose to use the telephone while driving, please use the hands-free device and only use the telephone when weather, road and traffic conditions permit. Some jurisdictions prohibit the driver from using a mobile phone while driving a vehicle. Bear in mind that at a speed of just 30 mph (approximately 50 km/h), your vehicle is covering a distance of 44 feet (approximately 14 m) every second.

- ▶ Switch on the mobile phone and COMAND APS (see the separate operating instructions).
- ▶ Press  or  on the steering wheel to select the **Telephone** menu.

You will see one of the following display messages in the multifunction display:

- Ready or the name of the network provider: the mobile phone has found a network and is ready to receive.
- No Service: No network is available.

### Accepting a call

If someone calls you when you are in the **Telephone** menu, a display message appears in the multifunction display, for example:

<sup>37</sup> Not in AMG vehicles.

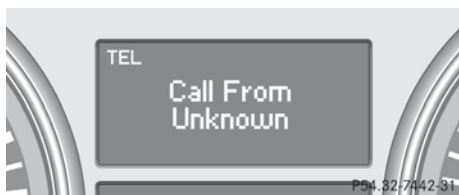

- ▶ Press  on the steering wheel to accept an incoming call.

If you are not in the **Telephone** menu, you can still accept a call.





### Rejecting or ending a call



- ▶ Press the  button on the steering wheel.

If you are not in the **Telephone** menu, you can still accept a call.

### Dialing a number from the phone book

You can enter new telephone numbers into the phone book via the mobile phone (see the separate operating instructions). If your mobile phone is operational, you can select and dial a number from the phone book at any time.

- ▶ Press  or  on the steering wheel to select the **Telephone** menu.
- ▶ Press the  or  button to select the desired name.

To start scrolling rapidly, press and hold the  or  button for longer than one second.







- ▶ Press  to start dialing.

or

- ▶ If you do not want to make a call, press the  button.

### Redialing

The on-board computer saves the last names or numbers dialed in the redial memory.

- ▶ Press  or  on the steering wheel to select the **Telephone** menu.
- ▶ Press the  button to switch to the redial memory.
- ▶ Press the  or  button to select the desired name or number.
- ▶ Press  to start dialing.

## Display messages





### Hiding display messages

#### Warning

All categories of messages contain important information which should be taken note of and, where a malfunction is indicated, addressed as soon as possible at an authorized Mercedes-Benz Center.

Failure to repair the condition noted may cause damage not covered by the Mercedes-Benz Limited Warranty, or result in property damage or personal injury.

Display messages appear in the multifunction display.

- ▶ Press the , ,  or  button on the steering wheel to select another display.
- or
- ▶ Press reset button  on the instrument cluster (▶ page 28).  
The display message is cleared.

The multifunction display shows high-priority display messages in red.

You cannot hide display messages of the highest priority. The multifunction display shows these messages continuously until the causes for the messages have been remedied.





Certain display messages are accompanied by an audible warning tone or a continuous tone.

Please respond in accordance with the display messages and follow the additional notes in this Operator's Manual.





### Message memory menu





The on-board computer saves certain display messages. You can call up the display messages in the **message memory** menu.

The **message memory** menu is only shown if any display messages have been stored.

- ▶ Press the  or  button repeatedly, until either the original menu or the **message memory** menu is shown.  
If there are display messages, the multifunction display shows, for example, 2 messages.
- ▶ Using  or  scroll through the display messages.

When the ignition is switched off, all display messages are deleted apart from some high-priority display messages. Once the causes of the high-priority display messages have been rectified, the corresponding display messages are also deleted.



Safety systems	
Display messages	Possible causes/consequences and ► Solutions
ESP Unavailable See Operator's Manual	<p> <b>Risk of accident</b></p> <p>ESP® (Electronic Stability Program) and therefore also PRE-SAFE® are temporarily unavailable. The self-diagnosis function might not be complete, for example. BAS (Brake Assist System) has also been deactivated.</p> <p>The brake system continues to function normally, but without the functions listed above.</p> <ul style="list-style-type: none"> <li>► Carefully drive a short distance making slight steering movements at a speed above 12 mph (20 km/h) If the display message disappears, the functions mentioned above are available again.</li> </ul> <p>If the display message continues to be displayed:</p> <ul style="list-style-type: none"> <li>► Drive on carefully.</li> <li>► Visit a qualified specialist workshop.</li> </ul>
	<p>ESP® and therefore also BAS and PRE-SAFE® are not available due to undervoltage.</p> <p>The brake system continues to function normally, but without the functions listed above.</p> <ul style="list-style-type: none"> <li>► Drive on carefully.</li> <li>► Visit a qualified specialist workshop immediately.</li> </ul>
	<p>If the display message is shown during the journey and the  warning lamp is flashing, then 4ETS (Electronic Traction System) is deactivated. The brakes on the drive wheels could otherwise overheat.</p> <ul style="list-style-type: none"> <li>► Let the brakes cool down until the display message disappears and the  warning lamp goes out. 4ETS is activated again.</li> </ul>
ESP Inoperative See Operator's Manual	<p> <b>Risk of accident</b></p> <p>ESP® and therefore also Brake Assist and PRE-SAFE® are not available due to a malfunction. The  warning lamp also lights up in the instrument cluster.</p> <p>The brake system continues to function normally, but without the functions listed above.</p> <ul style="list-style-type: none"> <li>► Drive on carefully.</li> <li>► Visit a qualified specialist workshop immediately.</li> </ul>

Display messages	Possible causes/consequences and ► Solutions
 Tele Aid Inoperative	<p>USA only: one or more main functions in the mbrace system are malfunctioning.</p> <p>Canada only: one or more main functions in the Tele Aid system are malfunctioning.</p> <ul style="list-style-type: none"> <li>► USA only: have the mbrace system checked at a qualified specialist workshop.</li> <li>► Canada only: have the Tele Aid system checked at a qualified specialist workshop.</li> </ul>
PRE-SAFE Inoperative See Operator's Manual	<p> <b>Risk of injury</b></p> <p>Important functions of PRE-SAFE® have failed. All other occupant safety systems, e.g. air bags, remain available.</p> <ul style="list-style-type: none"> <li>► Visit a qualified specialist workshop immediately.</li> </ul>
 Restraint Sys. Malfunction Service Required	<p> <b>Risk of injury</b></p> <p>The restraint systems are malfunctioning.</p> <ul style="list-style-type: none"> <li>► Visit a qualified specialist workshop immediately.</li> </ul>

 **Warning**

In the event a malfunction of the SRS is indicated as outlined above, the SRS may not be operational.

For your safety, we strongly recommend that you contact an authorized Mercedes-Benz Center immediately to have the system checked. Otherwise the SRS may not be activated when needed in an accident, which could result in serious or fatal injury, or it might deploy unexpectedly and unnecessarily which could also result in injury.



Display messages	Possible causes/consequences and ► Solutions
<p>Front Passenger Airbag Enabled See Operator's Manual</p>	<p>The front-passenger air bag is enabled during the journey, although:</p> <ul style="list-style-type: none"> <li>• there is a child, a small adult or an object weighing less than the system's weight threshold is on the front-passenger seat.</li> <li>• the front-passenger seat is unoccupied</li> </ul> <p>The system may detect the additional weight of objects on the seat or forces acting on the seat.</p> <ul style="list-style-type: none"> <li>► Pull over and stop the vehicle safely as soon as possible, paying attention to road and traffic conditions.</li> <li>► Engage the parking brake.</li> <li>► Switch off the ignition.</li> <li>► Open the front-passenger door.</li> <li>► Remove the child and the child restraint system from the front-passenger seat.</li> <li>► If necessary, secure the child in a child restraint system on a suitable rear seat.</li> <li>► Make sure that no forces are acting on the seat, such as: <ul style="list-style-type: none"> <li>• trapped books, bags, etc. lying on, behind or beside the seat</li> <li>• head restraints pressing against the headliner</li> </ul> </li> </ul> <p>The system may otherwise detect these forces and interpret the seat occupant's weight as greater than it actually is.</p> <ul style="list-style-type: none"> <li>► Make sure that the seat is unoccupied and has no objects placed on it, close the front-passenger door, and switch on the ignition.</li> </ul> <p>Observe the  <b>PASS AIR BAG OFF</b> indicator lamps (► page 42) and the multifunction display and check the following:</p> <p>Seat unoccupied and ignition switched on:</p> <ul style="list-style-type: none"> <li>• the  <b>PASS AIR BAG OFF</b> indicator lamp must light up and remain lit. When the indicator lamp is on, OCS (► page 42) has disabled the front-passenger air bag.</li> <li>• the display messages <b>Front Passenger Airbag Enabled See Operator's Manual</b> or <b>Front Passenger Airbag Disabled See Operator's Manual</b> must not appear in the multifunction display. Wait for a period of at least 60 seconds until the necessary system checks have been completed and to make sure that the display messages do not appear in the multifunction display.</li> </ul> <p>If these conditions are met, the front-passenger seat can be occupied again. Whether the  <b>PASS AIR BAG OFF</b> indicator lamp remains lit or goes out depends on how OCS classifies the occupant.</p> <p>If the conditions are not met, the system is not operating correctly.</p>

**Display messages****Possible causes/consequences and ► Solutions**

► Visit a qualified specialist workshop immediately.

 **Warning**

If the  **PASS AIR BAG OFF** indicator lamp remains off even after performing the above corrective steps, do not have any children 12 years old and under and other small individuals use the front-passenger seat until the system has been repaired.

Display messages	Possible causes/consequences and ► Solutions
<p>Front Passenger Airbag Disabled See Operator's Manual</p>	<p>The front-passenger air bag is disabled during the journey even though an adult or a person larger than a certain size is occupying the front-passenger seat. If additional forces are applied to the seat, the weight the system detects may be too low.</p> <ul style="list-style-type: none"> <li>► Pull over and stop the vehicle safely as soon as possible, paying attention to road and traffic conditions.</li> <li>► Engage the parking brake.</li> <li>► Switch off the ignition.</li> <li>► Have the occupant get out of the vehicle.</li> <li>► Set the seat higher (► page 94).</li> <li>► Make sure that no objects are exerting force on the seat, e.g. books, bags, etc. lying under, behind or beside the seat. These forces may otherwise cause the system to detect too low a weight and interpret the seat occupant's weight as less than it actually is.</li> <li>► Make sure that the seat is unoccupied and has no objects placed on it, close the front-passenger door, and switch on the ignition.</li> </ul> <p>Observe the  <b>PASS AIR BAG OFF</b> (► page 42) indicator lamps and the multifunction display and check the following:</p> <p>Seat unoccupied and ignition switched on:</p> <ul style="list-style-type: none"> <li>• the  <b>PASS AIR BAG OFF</b> indicator lamp must light up and remain lit. When the indicator lamp is on, OCS (► page 42) has disabled the front-passenger air bag.</li> <li>• the display messages Front Passenger Airbag Enabled See Operator's Manual or Front Passenger Airbag Disabled See Operator's Manual cannot appear in the multifunction display. Wait for a period of at least 60 seconds until the necessary system checks have been completed and to make sure that the display messages do not appear in the multifunction display.</li> </ul> <p>If these conditions are met, the front-passenger seat can be occupied again. Whether the  <b>PASS AIR BAG OFF</b> indicator lamp remains lit or goes out depends on how OCS classifies the occupant.</p> <p>If the conditions are not met, the system is not operating correctly.</p> <ul style="list-style-type: none"> <li>► Visit a qualified specialist workshop immediately.</li> </ul>

### Warning

If the  **PASS AIR BAG OFF** indicator lamp remains lit with an adult occupant on the front-passenger seat even after performing the above corrective steps, do not have any passenger use the front-passenger seat until the system has been repaired.

## Brakes

## Display messages

## Possible causes/consequences and ► Solutions

ABS  
ABS, ESP  
Unavailable See  
Operator's Manual

 **Risk of accident**

ABS (Anti-lock Brake System) and ESP® (Electronic Stability Program) and therefore also PRE-SAFE® are temporarily unavailable. The self-diagnosis function might not be complete, for example.

The brake system continues to function normally, but without the functions listed above. The wheels could therefore lock if you brake hard, for example.

- Carefully drive a short distance making slight steering movements at a speed above 12 mph (20 km/h)  
If the display message disappears, the functions mentioned above are available again.

If the display message continues to be displayed:

- Drive on carefully.
- Visit a qualified specialist workshop.

 **Risk of accident**

ABS, ESP® and therefore also PRE-SAFE® are not available due to undervoltage. BAS has also been deactivated.

The brake system continues to function normally, but without the functions listed above. The wheels could therefore lock if you brake hard, for example.

- Drive on carefully.
- Visit a qualified specialist workshop immediately.







ABS  
ABS, ESP  
Inoperative See  
Operator's Manual

 **Risk of accident**

ABS, ESP® and therefore also PRE-SAFE® are not available due to a malfunction. BAS has also been deactivated.

The brake system continues to function normally, but without the functions listed above. The wheels could therefore lock if you brake hard, for example.

- Drive on carefully.
- Visit a qualified specialist workshop immediately.

Display messages	Possible causes/consequences and ► Solutions
<p><b>BRAKE</b> (USA only)</p>  <p>(Canada only) EBV, ABS, ESP Inoperative See Operator's Manual</p>	<p> <b>Risk of accident</b></p> <p>EBD (Electronic Brake-force Distribution), ABS (Anti-lock Brake System), ESP® (Electronic Stability Program) and therefore also PRE-SAFE® are not available due to a malfunction. BAS (Brake Assist) is also deactivated.</p> <p>The brake system continues to function normally, but without the functions listed above. The wheels could therefore lock if you brake hard, for example.</p> <ul style="list-style-type: none"> <li>► Drive on carefully.</li> <li>► Visit a qualified specialist workshop immediately.</li> </ul>
 <p>Brake Wear</p>	<p>The brake pads/linings have reached their wear limit.</p> <ul style="list-style-type: none"> <li>► Visit a qualified specialist workshop.</li> </ul>
<p><b>BRAKE</b> (USA only)</p>  <p>(Canada only) Release Parking Brake</p>	<p>You are driving with the parking brake engaged. A warning tone also sounds.</p> <ul style="list-style-type: none"> <li>► Release the parking brake.</li> </ul>
<p><b>BRAKE</b> (USA only)</p>  <p>(Canada only) Check Brake Fluid Level</p>	<p> <b>Risk of accident</b></p> <p>There is insufficient brake fluid in the brake fluid reservoir. In addition, the red warning lamp <b>BRAKE</b>(USA only) or  (Canada only) in the instrument cluster lights up and a warning tone sounds.</p> <ul style="list-style-type: none"> <li>► Pull over and stop the vehicle safely as soon as possible, paying attention to road and traffic conditions. Do not continue driving under any circumstances.</li> <li>► Engage the parking brake.</li> <li>► Consult a qualified specialist workshop.</li> <li>► Do not add brake fluid. This will not rectify the malfunction.</li> </ul>

 **Warning**







Driving with the message Check Brake Fluid Level displayed can result in an accident. Have your brake system checked immediately.







Do not add brake fluid before checking the brake system. Overfilling the brake fluid reservoir can result in spilling brake fluid on hot engine parts and the brake fluid catching fire. You can be seriously burned.







## Lights





**i** Display messages about LEDs:

This display message will only appear if all LEDs have failed.

Display messages	Possible causes/consequences and ► Solutions
 Cornering Lamp Left or Cornering Lamp Right	The left or right-hand cornering light is faulty. ► Check whether you are permitted to change the bulb yourself (▷ page 111). or ► Visit a qualified specialist workshop.
 Low Beam Left or Low Beam Right	The left or right-hand low-beam headlamp is faulty. ► Check whether you are permitted to change the bulb yourself (▷ page 111). or ► Visit a qualified specialist workshop.
 Trailer Tail Lamp Left or Trailer Tail Lamp Right	The left or right-hand trailer tail light is faulty. ► Check whether you are permitted to change the bulb yourself. or ► Visit a qualified specialist workshop.
 Trailer Turn Signal Left or Trailer Turn Signal Right	The left or right-hand trailer turn signal lamp is faulty. ► Check whether you are permitted to change the bulb yourself. or ► Visit a qualified specialist workshop.
 Trailer Brake Lamp	The trailer brake lamp is faulty. ► Check whether you are permitted to change the bulb yourself. or ► Visit a qualified specialist workshop.
 Turn Signal Rear Left or Turn Signal Rear Right	The rear left-hand or rear right-hand turn signal is faulty. ► Check whether you are permitted to change the bulb yourself (▷ page 111). or ► Visit a qualified specialist workshop.

Display messages	Possible causes/consequences and ► Solutions
 <p>Turn Signal Front Left or Turn Signal Front Right</p>	<p>The front left-hand or front right-hand turn signal is faulty.</p> <ul style="list-style-type: none"> <li>► Check whether you are permitted to change the bulb yourself (▷ page 111).</li> </ul> <p>or</p> <ul style="list-style-type: none"> <li>► Visit a qualified specialist workshop.</li> </ul>
 <p>Turn Signal Left Mirror or Turn Signal Right Mirror</p>	<p>The turn signal in the left-hand and/or right-hand exterior mirror is faulty.</p> <ul style="list-style-type: none"> <li>► Check whether you are permitted to change the bulb yourself (▷ page 111).</li> </ul> <p>or</p> <ul style="list-style-type: none"> <li>► Visit a qualified specialist workshop.</li> </ul>
 <p>3rd Brake Lamp</p>	<p>The high-mounted brake lamp is faulty.</p> <ul style="list-style-type: none"> <li>► Check whether you are permitted to change the bulb yourself (▷ page 111).</li> </ul> <p>or</p> <ul style="list-style-type: none"> <li>► Visit a qualified specialist workshop.</li> </ul>
 <p>Brake Lamp Left or Brake Lamp Right</p>	<p>The left or right-hand brake lamp is faulty.</p> <ul style="list-style-type: none"> <li>► Check whether you are permitted to change the bulb yourself (▷ page 111).</li> </ul> <p>or</p> <ul style="list-style-type: none"> <li>► Visit a qualified specialist workshop.</li> </ul>
 <p>Tail Lamp Left or Tail Lamp Right</p>	<p>The left or right-hand tail lamp is faulty.</p> <ul style="list-style-type: none"> <li>► Check whether you are permitted to change the bulb yourself (▷ page 111).</li> </ul> <p>or</p> <ul style="list-style-type: none"> <li>► Visit a qualified specialist workshop.</li> </ul>
 <p>High Beam Left or High Beam Right</p>	<p>The left or right-hand high beam is faulty.</p> <ul style="list-style-type: none"> <li>► Check whether you are permitted to change the bulb yourself (▷ page 111).</li> </ul> <p>or</p> <ul style="list-style-type: none"> <li>► Visit a qualified specialist workshop.</li> </ul>

Display messages	Possible causes/consequences and ► Solutions
 License Plate Lamp Left or License Plate Lamp Right	The left or right-hand license plate lamp is faulty. The left or right-hand license plate lamp is faulty. ► Check whether you are permitted to change the bulb yourself (> page 111). or ► Visit a qualified specialist workshop.
 Front Foglamp Left or Front Foglamp Right	The left-hand or right-hand front fog lamp is faulty. The left-hand or right-hand front fog lamp is faulty. ► Check whether you are permitted to change the bulb yourself (> page 111). or ► Visit a qualified specialist workshop.
 Foglamp Rear Left or Foglamp Rear Right	The left-hand or right-hand rear fog lamp is faulty. ► Check whether you are permitted to change the bulb yourself (> page 111). or ► Visit a qualified specialist workshop.
 Parking Lamp Front Left or Parking Lamp Front Right	The front left or front right standing lamp is faulty. ► Check whether you are permitted to change the bulb yourself (> page 111). or ► Visit a qualified specialist workshop.
 Reverse Lamp Left or Reverse Lamp Right	The left or right-hand backup lamp is faulty. ► Check whether you are permitted to change the bulb yourself (> page 111). or ► Visit a qualified specialist workshop.
 Marker Lamp Front Left or Marker Lamp Front Right	The front left or right side marker lamp is faulty. ► Check whether you are permitted to change the bulb yourself (> page 111). or ► Visit a qualified specialist workshop.

Display messages	Possible causes/consequences and ► Solutions
 Daytime Running Light Left or Daytime Running Light Right	The left or right-hand daytime running light is defective. <ul style="list-style-type: none"> <li>► Check whether you are permitted to change the bulb yourself (▷ page 111).</li> </ul> or <ul style="list-style-type: none"> <li>► Visit a qualified specialist workshop.</li> </ul>
 Active Headlamps Inoperative	The active light function is faulty. <ul style="list-style-type: none"> <li>► Visit a qualified specialist workshop.</li> </ul>
 AUTO Light Inoperative	The light sensor is faulty. The low-beam headlamps are switched on. <ul style="list-style-type: none"> <li>► USA only: switch off daytime driving lights in the on-board computer (▷ page 215).</li> <li>► Switch the lights on and off using the light switch.</li> <li>► Visit a qualified specialist workshop.</li> </ul>
 Switch Off Lights	The lights are still switched on when you leave the vehicle. A warning tone also sounds. <ul style="list-style-type: none"> <li>► Turn the light switch to <input type="checkbox"/> 0 or <input type="checkbox"/> A.</li> </ul> or <ul style="list-style-type: none"> <li>► If the rear fog lamp is switched on: press the light switch in to the stop.</li> </ul>

## Engine

Display messages	Possible causes/consequences and ► Solutions
 Top Up Coolant See Operator's Manual	The coolant level is too low. <ul style="list-style-type: none"> <li>► Add coolant, observing the warning notes before doing so (▷ page 285).</li> <li>► If coolant needs adding more often than usual, have the engine coolant system checked at a qualified specialist workshop.</li> </ul>

### Warning

Do not spill antifreeze on hot engine parts. Antifreeze contains ethylene glycol which may burn if it comes into contact with hot engine parts. You could be seriously burned.

**!** The coolant level is too low. Avoid making long journeys with too little coolant in the cooling system. The engine will otherwise be damaged.

The display messages and the corresponding symbol that indicate that the coolant level is too low must not be ignored.

Display messages	Possible causes/consequences and ► Solutions
 <p data-bbox="84 300 330 355">Coolant Stop car. switch engine off</p>	<p data-bbox="341 244 1002 276">The coolant is too hot.</p> <ul style="list-style-type: none"> <li data-bbox="341 284 1002 339">► Pull over and stop the vehicle safely and switch off the engine, paying attention to road and traffic conditions.</li> <li data-bbox="341 347 1002 403">► Make sure that the air supply to the radiator is not blocked, e.g. by snow, slush or ice.</li> <li data-bbox="341 411 1002 467">► Wait until the display message disappears before restarting the engine. Otherwise, there is a risk of engine damage.</li> <li data-bbox="341 475 1002 507">► Pay attention to the coolant temperature display.</li> <li data-bbox="341 515 1002 571">► If the temperature increases again, visit a qualified specialist workshop immediately.</li> </ul> <p data-bbox="341 595 1002 627">The poly-V-belt may have torn.</p> <ul style="list-style-type: none"> <li data-bbox="341 635 1002 691">► Pull over and stop the vehicle safely and switch off the engine, paying attention to road and traffic conditions.</li> <li data-bbox="341 699 1002 730">► Open the hood.</li> <li data-bbox="341 738 1002 770">► Check whether the poly-V-belt is torn.</li> </ul> <p data-bbox="341 778 1002 810"><b>If the poly-V-belt is torn:</b></p> <ul style="list-style-type: none"> <li data-bbox="341 818 1002 850">! Do not continue driving. The engine could otherwise overheat.</li> <li data-bbox="341 858 1002 890">► Consult a qualified specialist workshop.</li> </ul> <p data-bbox="341 898 1002 930"><b>If the poly-V-belt is OK:</b></p> <ul style="list-style-type: none"> <li data-bbox="341 938 1002 994">► Wait until the display message disappears before restarting the engine. Otherwise, there is a risk of engine damage.</li> <li data-bbox="341 1002 1002 1034">► Pay attention to the coolant temperature display.</li> <li data-bbox="341 1042 1002 1066">► Visit a qualified specialist workshop.</li> </ul>





### Warning

Driving when your engine is overheated can cause some fluids which may have leaked into the engine compartment to catch fire. You could be seriously burned.

Steam from an overheated engine can cause serious burns which can occur just by opening the engine hood. Stay away from the engine if you see or hear steam coming from it.

Stop the vehicle in a safe location away from other traffic. Turn off the engine, get out of the vehicle and do not stand near the vehicle until the engine has cooled down.









**!** If the coolant temperature exceeds 248 °F (120 °C) do not continue driving. The engine will otherwise be damaged.







Display messages	Possible causes/consequences and ► Solutions
	<p>The engine fan is faulty.</p> <ul style="list-style-type: none"> <li>► At coolant temperatures under 248 °F(120 °C), drive to the next qualified specialist workshop.</li> <li>► Avoid subjecting the engine to heavy loads, e.g. driving in mountainous terrain, and stop-start driving.</li> </ul>
	<p>The battery is not being charged.</p> <p>Possible causes are:</p> <ul style="list-style-type: none"> <li>• a faulty alternator</li> <li>• a torn poly-V-belt</li> <li>• a malfunction in the electronics</li> </ul> <ul style="list-style-type: none"> <li>► Pull over and stop the vehicle safely and switch off the engine, paying attention to road and traffic conditions.</li> <li>► Open the hood.</li> <li>► Check whether the poly-V-belt is torn.</li> </ul> <p><b>If the poly-V-belt is torn:</b></p> <p><b>!</b> Do not continue driving. The engine could otherwise overheat.</p> <ul style="list-style-type: none"> <li>► Consult a qualified specialist workshop.</li> </ul> <p><b>If the poly-V-belt is OK:</b></p> <ul style="list-style-type: none"> <li>► Visit a qualified specialist workshop.</li> </ul>
 <p>Battery/ Alternator Stop Vehicle</p>	<p>The battery is faulty.</p> <ul style="list-style-type: none"> <li>► Pull over and stop the vehicle safely as soon as possible, paying attention to road and traffic conditions. Do not continue driving under any circumstances.</li> <li>► Engage the parking brake.</li> <li>► Consult a qualified specialist workshop.</li> </ul>
 <p>Check engine oil level at next refueling</p>	<p>The oil level is too low.</p> <ul style="list-style-type: none"> <li>► Check the oil level (▷ page 283).</li> <li>► If necessary, add the engine oil (▷ page 284).</li> <li>► Have the engine checked for leaks if engine oil has to be added more often than usual.</li> </ul>









Information on approved engine oils can be obtained from any qualified specialist workshop or on the Internet at <http://www.mbusa.com> (USA only).





**!** The oil level is too low. Avoid long journeys with too little engine oil. There is a risk of engine damage.

The display messages and the corresponding symbol that indicate that the oil level is too low must not be ignored.

Display messages	Possible causes/consequences and ► Solutions
	There is only a small amount of fuel in the fuel tank. ► Refuel at the nearest gas station.
 Reserve Fuel	The fuel level has fallen below the reserve range. The fuel tank must be filled up to at least the reserve fuel level; otherwise, engine running may be impaired. ► Refuel at the nearest gas station.
 Gas Cap Open	The fuel system pressure is too low. The fuel filler cap is not closed correctly or the fuel system is leaking. ► Check that the fuel filler cap is correctly closed. ► <b>If the fuel filler cap is not correctly closed:</b> close the fuel filler cap. ► <b>If the fuel filler cap is closed:</b> visit a qualified specialist workshop.
 Ultra Low-sulfur Diesel Fuel Only	Vehicles with a diesel engine: the fuel level has fallen below the reserve range. ► Check that the fuel filler cap is correctly closed. ► Refuel at the nearest gas station. ► Only use commercially available vehicular ULTRA-LOW SULFUR DIESEL FUEL (ULSD, 15 ppm SULFUR MAXIMUM).
 Replace air filter	Vehicles with a diesel engine: the engine air filter is contaminated and must be replaced. ► Visit a qualified specialist workshop.
 Clean Fuel Filter	Vehicles with a diesel engine: there is water in the fuel filter. The water must be drained off. ► Visit a qualified specialist workshop.
 Check Additive See Operator's Manual	The AdBlue® tank is empty. ► Have the AdBlue® tank filled as soon as possible at a qualified specialist workshop (► page 156). Visit a qualified specialist workshop.
 Remaining Starts: 20	The AdBlue® level has fallen to a minimum. ► Have the AdBlue® tank filled as soon as possible at a qualified specialist workshop (► page 156). Visit a qualified specialist workshop.

Driving systems	
Display messages	Possible causes/consequences and ► Solutions
 Level Selection Not Permitted	You cannot change the vehicle level, because: <ul style="list-style-type: none"> <li>• you are exceeding the permissible speed for the selected vehicle level.</li> <li>• you are towing a trailer.</li> <li>• the trailer-coupling socket is being used, e.g. for a bicycle rack.</li> </ul> ► Drive more slowly and then select the desired vehicle level again (► page 184). ► Observe the notes on towing a trailer (► page 198).
 Compressor Cooling Down	You have selected a higher vehicle level. The compressor first needs to cool down because of frequent level changes. <ul style="list-style-type: none"> <li>► Drive in a manner appropriate for the current vehicle level.</li> <li>► Make sure that there is sufficient ground clearance.</li> <li>► Allow the compressor to cool down.</li> </ul> When the compressor has cooled down, the display message disappears. The vehicle then continues rising to the selected level.
 Malfunction	Level control is faulty. <ul style="list-style-type: none"> <li>► Do not drive faster than 50 mph(80 km/h).</li> <li>► Make sure that there is sufficient ground clearance.</li> <li>► Have the vehicle checked at a qualified specialist workshop.</li> </ul>
 Rising Max. 12 MPH	The vehicle is being adjusted to off-road level 3. The display message informs you of the maximum speed permissible for off-road level 3. <ul style="list-style-type: none"> <li>► Do not drive faster than 12 mph(20 km/h).</li> </ul>
 Max. 12 MPH	You are driving in off-road level 3. The display message informs you of the maximum speed permissible for off-road level 3. <ul style="list-style-type: none"> <li>► Do not drive faster than 12 mph(20 km/h).</li> </ul>
 Being lowered Max. 12 MPH	The vehicle is being lowered from off-road level 3 to off-road level 2. The display message informs you of the maximum speed permissible for off-road level 3. <ul style="list-style-type: none"> <li>► Do not driver faster than 12 mph(20 km/h) until off-road level 2 is reached.</li> </ul>

Display messages	Possible causes/consequences and ► Solutions
 <p>Reduce speed to under 12 MPH</p>	<p> <b>Risk of accident</b></p> <p>You are exceeding the speed permissible for the selected off-road level.</p> <ul style="list-style-type: none"> <li>► Adjust your driving style to the altered handling characteristics.</li> <li>► Only make slight steering movements and avoid fast steering movements.</li> <li>► Take account of the altered handling characteristics.</li> <li>► Do not driver faster than 12 mph(20 km/h).</li> </ul>
 <p>Locking System Inoperative Service Required</p>	<p>The differential locks are faulty.</p> <ul style="list-style-type: none"> <li>► Do not drive faster than 50 mph (80 km/h).</li> <li>► Have the vehicle checked at a qualified specialist workshop.</li> </ul>
 <p>Diff. Lock System Overheated - Wait briefly</p>	<p>The differential locks are too hot and have been disengaged.</p> <ul style="list-style-type: none"> <li>► Drive on carefully.</li> <li>► Allow the differential locks to cool down. The differential locks reengage as soon as they have cooled down.</li> </ul>
 <p>Stop vehicle, engage parking brake</p>	<p>A gearshift process has been canceled. LOW RANGE is in the neutral position. There is no connection between the engine and the drive wheels.</p> <ul style="list-style-type: none"> <li>► Pull over and stop the vehicle safely as soon as possible, paying attention to road and traffic conditions.</li> <li>► Engage the parking brake. Do not continue driving under any circumstances.</li> <li>► Repeat the gearshift process.</li> </ul>
 <p>Service Required If parked engage pk. brake</p>	<p>The LOW RANGE system is malfunctioning.</p> <ul style="list-style-type: none"> <li>► Do not drive faster than 50 mph (80 km/h).</li> <li>► Engage the parking brake to park.</li> <li>► Have the vehicle checked at a qualified specialist workshop.</li> </ul>
 <p>Max. Speed 25 MPH</p>	<p>You have exceeded the maximum speed for the gearshift process.</p> <ul style="list-style-type: none"> <li>► Drive slower. The gearshift process is carried out.</li> </ul>
 <p>Max. Speed 40 MPH</p>	<p>You have exceeded the maximum speed for the gearshift process.</p> <ul style="list-style-type: none"> <li>► Drive slower. The gearshift process is carried out.</li> </ul>

Display messages	Possible causes/consequences and ► Solutions
 <p>Shift briefly into N</p>	<p>You have reduced the vehicle speed, but the automatic transmission is not in position <b>N</b>.</p> <p>► Briefly shift the automatic transmission to position <b>N</b>.</p>
 <p>Shifting Process Canceled Reactivate</p>	<p>The gearshift process has been canceled.</p> <p>► Repeat the gearshift process.</p>
 <p>Inoperative</p>	<p>DSR (Downhill Speed Regulation) is deactivated due to a malfunction.</p> <p>► Have DSR checked at a qualified specialist workshop.</p>
<p>Blind Spot Assist Currently Unavailable See Operator's Manual</p>	<p>Blind Spot Assist is temporarily inoperative if:</p> <ul style="list-style-type: none"> <li>• the sensors are dirty.</li> <li>• its function is impaired due to heavy rain or snow.</li> <li>• the radar sensor system is outside the operating temperature range.</li> <li>• the radar sensor system is temporarily inoperative, e.g. due to electromagnetic radiation emitted by nearby TV or radio stations or other sources of electromagnetic radiation.</li> <li>• the on-board voltage is too low.</li> </ul> <p>The yellow  indicator lamps also light up in the exterior mirrors.</p> <p>Blind Spot Assist is operational again and the display message disappears when:</p> <ul style="list-style-type: none"> <li>• the dirt (e.g. slush) drops away while the vehicle is in motion.</li> <li>• the system detects that the sensors are fully available again.</li> <li>• the radar sensor system is back within the operating temperature range.</li> </ul> <p>If the display message continues to be displayed:</p> <p>► Clean the sensors (▷ page 291).</p> <p>► Restart the engine.</p>
<p>Blind Spot Assist Inoperative</p>	<p>Blind Spot Assist is faulty.</p> <p>The yellow  indicator lamps also light up in the exterior mirrors.</p> <p>► Visit a qualified specialist workshop.</p>
<p>Cruise Control Inoperative</p>	<p>Cruise control is faulty.</p> <p>► Visit a qualified specialist workshop.</p>

Display messages	Possible causes/consequences and ► Solutions
Cruise Control --- mph	<p>A condition for activating cruise control has not been met. You wanted to save a speed of less than 20 mph (30 km/h).</p> <ul style="list-style-type: none"> <li>► If the situation allows, drive faster than 20 mph (30 km/h) and save the speed.</li> <li>► Check the activation conditions for cruise control (► page 171).</li> </ul>
DISTRONIC --- MPH	<p>An activation condition for DISTRONIC is not fulfilled.</p> <ul style="list-style-type: none"> <li>► If the situation allows, drive faster than 20 mph (30 km/h) and save the speed.</li> <li>► Check activation conditions for DISTRONIC (► page 173).</li> </ul>
DISTRONIC Override	<p>DISTRONIC is no longer controlling the speed of the vehicle.</p> <ul style="list-style-type: none"> <li>► Take your foot off the accelerator pedal.</li> </ul>
DISTRONIC Inoperative	<p>DISTRONIC is faulty or the display has failed.</p> <ul style="list-style-type: none"> <li>► Visit a qualified specialist workshop.</li> </ul>
DISTRONIC Currently Unavailable See Operator's Manual	<p>DISTRONIC is deactivated and is temporarily inoperative if:</p> <ul style="list-style-type: none"> <li>• the DISTRONIC cover in the radiator grill is dirty.</li> <li>• its function is impaired due to heavy rain, snow or fog.</li> <li>• the radar sensor system is temporarily inoperative, e.g. due to electromagnetic radiation emitted by nearby TV or radio stations or other sources of electromagnetic radiation.</li> <li>• the radar sensor system has not detected any vehicles or stationary objects, e.g. traffic signs, for a long time.</li> <li>• the system is outside the operating temperature range.</li> </ul> <p>DISTRONIC becomes available again and the display message disappears when:</p> <ul style="list-style-type: none"> <li>• the dirt (e.g. slush) drops away while the vehicle is in motion.</li> <li>• the system detects that the sensors are fully available again.</li> <li>• the system is within the operating temperature range.</li> </ul> <p>If the display message continues to be displayed:</p> <ul style="list-style-type: none"> <li>► Clean the DISTRONIC cover in the radiator grill (► page 291).</li> <li>► Restart the engine.</li> </ul>

### Warning

DISTRONIC cannot take weather conditions into account. Switch off DISTRONIC or do not turn it on if the sensor is dirty or visibility is diminished as a result of snow, rain or fog. The distance control may be impaired even before the system is able to detect a dirty sensor. The DISTRONIC

Currently Unavailable See Operator's Manual message will be displayed in the multifunction display and DISTRONIC will be turned off.

**Tires**

 **Warning**

Do not drive with a flat tire. A flat tire affects the ability to steer or brake the vehicle. You may lose control of the vehicle. Continued driving with a flat tire will cause excessive heat build-up and possibly a fire.



 **Warning**





Follow recommended tire inflation pressures.

Do not underinflate tires. Underinflated tires wear excessively and/or unevenly, adversely affect handling and fuel economy, and are more likely to fail from being overheated.

Do not overinflate tires. Overinflated tires can adversely affect handling and ride comfort, wear unevenly, increase stopping distance, and result in sudden deflation (blowout) because they are more likely to become punctured or damaged by road debris, potholes etc.





Display messages	Possible causes/consequences and ► Solutions
Tire Pressure Check Tires	<p> <b>Risk of accident</b></p> <p>The tire pressure loss warning system has detected a significant loss in pressure.</p> <ul style="list-style-type: none"> <li>► Stop the vehicle without making any sudden steering or braking maneuvers. Pay attention to the traffic conditions as you do so.</li> <li>► Check the tires and, if necessary, change the wheel (▷ page 340).</li> <li>► Check the tire pressures and, if necessary, set to the correct tire pressure.</li> <li>► Restart the tire pressure loss warning system when the tire pressure is correct (▷ page 329).</li> </ul>
Check tires, then restart Run Flat Indicator	<p>A display message for the tire pressure loss warning system was shown.</p> <ul style="list-style-type: none"> <li>► Set the correct tire pressure in all four tires.</li> <li>► Restart the tire pressure loss warning system (▷ page 329).</li> </ul>
Run Flat Indicator Inoperative	<p>The tire pressure loss warning system is faulty.</p> <ul style="list-style-type: none"> <li>► Visit a qualified specialist workshop.</li> </ul>
Tire pressure displayed after driving for a few minutes	<p>The tire pressure monitor is measuring the tire pressure.</p> <ul style="list-style-type: none"> <li>► Drive on.</li> </ul> <p>The tire pressures appear in the multifunction display after you have been driving for a few minutes.</p>



Display messages	Possible causes/consequences and ► Solutions
Tire Pressure Monitor Inoperative	The TPMS is faulty. ► Visit a qualified specialist workshop.
Tire Pressure Monitor Inoperative No Wheel Sensors	The wheels mounted do not have a suitable tire pressure sensor. The tire pressure monitor is deactivated. ► Mount wheels with suitable tire pressure sensors. The TPMS is activated automatically after driving for a few minutes.
Check Tire(s)	 <b>Risk of accident</b> The tire pressure in one or more tires has dropped significantly. The wheel position is displayed in the multifunction display. ► Stop the vehicle without making any sudden steering or braking maneuvers. Pay attention to the traffic conditions as you do so. ► Correct the tire pressure (▷ page 331). ► If necessary, change the wheel (▷ page 340).
Caution: Tire Defect	 <b>Risk of accident</b> The tire pressure in one or more tires has dropped suddenly. The wheel position is displayed in the multifunction display. ► Stop the vehicle without making any sudden steering or braking maneuvers. Pay attention to the traffic conditions as you do so. ► If necessary, change the wheel (▷ page 340).
Tire pressure(s) Please Correct	The tire pressure is insufficient in at least one of the tires or the tire pressure difference between the wheels is too great. The wheel position is displayed in the multifunction display. ► Check the tire pressures at the next opportunity. If necessary, correct the tire pressure (▷ page 331). ► Restart the tire pressure monitor (▷ page 333).
Tire Pressure Monitor Wheel Sensor Missing	There is no signal from the tire pressure sensor of one or several wheels. The pressure of the affected tire is not displayed in the multifunction display. ► Have the faulty tire pressure sensor replaced at a qualified specialist workshop.

Display messages	Possible causes/consequences and ► Solutions
Tire Pressure Monitor Currently Unavailable	Due to a source of radio interference no signals can be received from the wheel sensors. The tire pressure monitor is temporarily malfunctioning. ► Drive on. The TPMS restarts automatically as soon as the problem has been solved.
 Tire Pressure Caution: Tire Defect	 <b>Risk of accident</b> The tire pressure in one or more tires has dropped suddenly. ► Stop the vehicle without making any sudden steering or braking maneuvers. Pay attention to the traffic conditions as you do so. ► If necessary, change the wheel (▷ page 340).
 Tire Pressure Check Tires	 <b>Risk of accident</b> The tire pressure in one or more tires has dropped significantly. ► Stop the vehicle without making any sudden steering or braking maneuvers. Pay attention to the traffic conditions as you do so. ► If necessary, change the wheel (▷ page 340). ► Check the tire pressure. If necessary, correct the tire pressure (▷ page 331).
 Please correct the tire pressures	The tire pressure is insufficient in at least one of the tires or the tire pressure difference between the wheels is too great. ► Check the tire pressures at the next opportunity. If necessary, correct the tire pressure (▷ page 331).





## Vehicle





Display messages	Possible causes/consequences and ► Solutions
Shift to P or N to start engine	You have attempted to start the engine with the transmission in position <b>R</b> or <b>D</b> . ► Shift the transmission to position <b>P</b> or <b>N</b> .
Auxiliary Battery Malfunction	The auxiliary battery for the automatic transmission is no longer being charged. ► Visit a qualified specialist workshop.
Depress brake to shift out of P	You have attempted to move the transmission selector lever to position <b>D</b> , <b>R</b> or <b>N</b> without depressing the brake pedal. ► Depress the brake pedal.

Display messages	Possible causes/consequences and ► Solutions
Door Open Vehicle Not In Park	The driver's door is open and the transmission is in position <b>R</b> , <b>N</b> or <b>D</b> . ► Shift the transmission to position <b>P</b> . ► Engage the parking brake.
Drive to workshop without shifting gears	You cannot change the transmission position due to a malfunction. If transmission position <b>D</b> is selected: ► Drive to a qualified specialist workshop without shifting the transmission from position <b>D</b> . If transmission position <b>R</b> , <b>N</b> or <b>P</b> is selected: ► Notify a qualified specialist workshop or breakdown service.
Only shift to P when vehicle is at a standstill	The vehicle is moving. ► Pull over and stop the vehicle safely as soon as possible, paying attention to road and traffic conditions. ► Shift the transmission to position <b>P</b> .
	 <b>Risk of accident</b> The hood or the tailgate is open. ► Pull over and stop the vehicle safely as soon as possible, paying attention to road and traffic conditions. ► Engage the parking brake. ► Close the hood or tailgate.  You have attempted to lock the vehicle with KEYLESS-GO while the tailgate or door is open. ► Close all doors and/or the tailgate.
	At least one door is open. ► Close all doors.
 Power Steering Malfunction See Operator's Manual	 <b>Risk of accident</b> The power steering assistance is faulty. You will need to use more force to steer. ► Check whether you are able to apply the extra force required. ► <b>If you are able to steer safely:</b> carefully drive on to a qualified specialist workshop. ► <b>If you are unable to steer safely:</b> do not drive on. Contact the nearest qualified specialist workshop.

Display messages	Possible causes/consequences and ► Solutions
No Service	Your vehicle is outside the network provider transmitter/receiver range. ► Wait until the mobile phone operational readiness symbol appears in the multifunction display.
 Bluetooth Ready	The Bluetooth® connection between your mobile phone and COMAND is not activated. ► If desired, activate the Bluetooth® connection between the mobile phone and COMAND (see the separate operating instructions).
 Top Up Washer Fluid	The washer fluid level has dropped to approximately 1/3 of the total reservoir capacity. ► Add washer fluid (► page 286).





**SmartKey**

Display messages	Possible causes/consequences and ► Solutions
 Please replace key	The SmartKey needs to be replaced. ► Visit a qualified specialist workshop.
 Remove key	The SmartKey is in the ignition lock. ► Remove the SmartKey.
 Don't Forget Your Key	The display message is shown for a maximum of 60 seconds and is only a reminder. You are opening the driver's door with the engine switched off. The SmartKey is not in the ignition lock. ► Take the SmartKey with you when you leave the vehicle.
 Key Does Not Belong To Vehicle	You have put the wrong key in the ignition lock. ► Use the correct key.
 Change Key Batteries	The batteries of the KEYLESS-GO key are discharged. ► Change the batteries (► page 75).

Display messages	Possible causes/consequences and ► Solutions
 <p>Key Not Detected (red display message)</p>	<p>The KEYLESS-GO key is not in the vehicle.</p> <p>If the engine is switched off, you can no longer lock the vehicle centrally or start the engine.</p> <ul style="list-style-type: none"> <li>► Pull over and stop the vehicle safely as soon as possible, paying attention to road and traffic conditions.</li> <li>► Engage the parking brake.</li> <li>► Locate the KEYLESS-GO key.</li> </ul> <p>The KEYLESS-GO key is not detected while the engine is running because there is interference from a strong source of radio waves.</p> <ul style="list-style-type: none"> <li>► Pull over and stop the vehicle safely as soon as possible, paying attention to road and traffic conditions.</li> <li>► Engage the parking brake.</li> <li>► Operate the vehicle with the SmartKey in the ignition lock if necessary.</li> </ul>
 <p>Key Not Detected (white display message)</p>	<p>The KEYLESS-GO key cannot be detected at present.</p> <ul style="list-style-type: none"> <li>► Change the location of the SmartKey with the KEYLESS-GO functions in the vehicle.</li> </ul> <p>If the KEYLESS-GO key is still not detected:</p> <ul style="list-style-type: none"> <li>► Change the location of the SmartKey with the KEYLESS-GO functions in the vehicle.</li> <li>► Operate the vehicle with the key in the ignition lock if necessary.</li> </ul>
 <p>Key Detected In Vehicle</p>	<p>The KEYLESS-GO key has been detected inside the vehicle during locking.</p> <ul style="list-style-type: none"> <li>► Remove the KEYLESS-GO key from the vehicle.</li> </ul>
 <p>Pull starting button out then insert key</p>	<p>The KEYLESS-GO key can continuously not be detected.</p> <ul style="list-style-type: none"> <li>► Insert the SmartKey into the ignition lock and turn it to the desired position.</li> <li>► Visit a qualified specialist workshop.</li> </ul>

## Warning and indicator lamps in the instrument cluster









## Brakes





Problem	Possible causes/consequences and ► Solutions
<p> (USA only)   (Canada only)</p> <p>The red brake system warning lamp comes on while the vehicle is moving. A warning tone also sounds.</p>	<p>You are driving with the parking brake engaged.</p> <ul style="list-style-type: none"> <li>► Release the parking brake.</li> </ul> <p>The warning lamp goes out and the warning tone ceases.</p>
<p> (USA only)   (Canada only)</p> <p>The red brake system warning lamp comes on while the engine is running. A warning tone also sounds.</p>	<p> <b>Risk of accident</b></p> <p>There is insufficient brake fluid in the fluid reservoir.</p> <ul style="list-style-type: none"> <li>► Pull over and stop the vehicle safely as soon as possible, paying attention to road and traffic conditions. Do not continue driving under any circumstances.</li> <li>► Engage the parking brake.</li> <li>► Consult a qualified specialist workshop immediately.</li> <li>► Observe the additional display messages in the multifunction display.</li> </ul> <p>Do not add brake fluid. This will not rectify the malfunction.</p>









 **Warning**







Driving with the brake warning lamp illuminated can result in an accident. Have your brake system checked immediately if the brake warning lamp stays on. Do not add brake fluid before checking the brake system.

Overfilling the brake fluid reservoir can result in spilling brake fluid on hot engine parts and the brake fluid catching fire. You can be seriously burned.

Seat belts	
Problem	Possible causes/consequences and ► Solutions
 <p>After starting the engine, the red seat belt warning lamp lights up for 6 seconds.</p>	<p>The seat belt warning lamp reminds the driver and front passenger to fasten their seat belts.</p> <ul style="list-style-type: none"> <li>► Fasten your seat belt (▷ page 53).</li> </ul>
 <p>After starting the engine, the red seat belt warning lamp lights up. In addition, a warning tone sounds for up to 6 seconds.</p>	<p> <b>Risk of injury</b></p> <p>The driver's seat belt is not fastened.</p> <ul style="list-style-type: none"> <li>► Fasten your seat belt (▷ page 53). The warning tone ceases.</li> </ul>
 <p>The red seat belt warning lamp lights up after the engine starts, as soon as the driver's or the front-passenger door is closed.</p>	<p> <b>Risk of injury</b></p> <p>The driver or front passenger has not fastened their seat belt.</p> <ul style="list-style-type: none"> <li>► Fasten your seat belt (▷ page 53). The warning lamp goes out.</li> </ul>
	<p> <b>Risk of injury</b></p> <p>There are objects on the front-passenger seat.</p> <ul style="list-style-type: none"> <li>► Remove the objects from the front-passenger seat and stow them in a secure place. The warning lamp goes out.</li> </ul>
 <p>The red seat belt warning lamp flashes and an intermittent audible warning sounds.</p>	<p> <b>Risk of injury</b></p> <p>The driver or front passenger has not fastened their seat belt. In addition, you are driving faster than 15 mph (25 km/h) or you have briefly driven faster than 15 mph (25 km/h).</p> <ul style="list-style-type: none"> <li>► Fasten your seat belt (▷ page 53). The warning lamp goes out and the intermittent audible warning ceases.</li> </ul>
	<p> <b>Risk of injury</b></p> <p>There are objects on the front-passenger seat. In addition, you are driving faster than 15 mph (25 km/h) or you have briefly driven faster than 15 mph (25 km/h).</p> <ul style="list-style-type: none"> <li>► Remove the objects from the front-passenger seat and stow them in a secure place. The warning lamp goes out and the intermittent audible warning ceases.</li> </ul>

Safety systems	
Problem	Possible causes/consequences and ► Solutions
 <p>The yellow ABS warning lamp is lit while the engine is running.</p>	<p> <b>Risk of accident</b></p> <p>ABS (Anti-lock Brake System) is deactivated due to a malfunction. Therefore, BAS (Brake Assist), ESP® (Electronic Stability Program), EBD (Electronic Brake-force Distribution) and PRE-SAFE® are also deactivated.</p> <p>The brake system continues to function normally, but without the functions listed above. The wheels could therefore lock if you brake hard, for example.</p> <ul style="list-style-type: none"> <li>► Observe the additional display messages in the multifunction display.</li> <li>► Drive on carefully.</li> <li>► Visit a qualified specialist workshop.</li> </ul> <p>If the ABS control unit is faulty, there is also a possibility that other systems, such as the navigation system or the automatic transmission, will not be available.</p>
 <p>The yellow ABS warning lamp is lit while the engine is running.</p>	<p> <b>Risk of accident</b></p> <p>The on-board voltage is too low. ABS has been deactivated due to undervoltage.</p> <p>Therefore, ESP®, BAS and PRE-SAFE® are also deactivated.</p> <p>The brake system continues to function normally, but without the functions listed above. The wheels could therefore lock if you brake hard, for example.</p> <ul style="list-style-type: none"> <li>► Switch off consumers that are not required, e.g. the rear window defroster or interior lighting. ABS will be available again as soon as the vehicle's on-board electrical system voltage increases.</li> </ul> <p>If the warning lamp is still on:</p> <ul style="list-style-type: none"> <li>► Have the battery and alternator checked at a qualified specialist workshop.</li> </ul>
 <p>The yellow ABS warning lamp is lit while the engine is running.</p>	<p>Self diagnosis is not yet complete.</p> <ul style="list-style-type: none"> <li>► Carefully drive a suitable distance making slight steering movements at a speed above 12 mph (20 km/h).</li> </ul>





Problem	Possible causes/consequences and ► Solutions
<p>  (USA only)   (Canada only)    </p> <p>The red brake warning lamp, the yellow ESP<sup>®</sup> and ESP<sup>®</sup> OFF warning lamps and the yellow ABS warning lamp are lit while the engine is running. A warning tone also sounds.</p>	<p>  <b>Risk of accident</b> </p> <p>EBD is faulty. Therefore, ABS, BAS, PRE-SAFE<sup>®</sup>, hill start assist and ESP<sup>®</sup> trailer stabilization are also not available due to a malfunction.</p> <p>The brake system continues to function normally, but without the functions listed above. The wheels could therefore lock if you brake hard, for example.</p> <ul style="list-style-type: none"> <li>► Observe the additional display messages in the multifunction display.</li> <li>► Drive on carefully.</li> <li>► Visit a qualified specialist workshop.</li> </ul>
<p>  </p> <p>The yellow ESP<sup>®</sup> warning lamp flashes while the vehicle is in motion.</p>	<p>  <b>Risk of accident</b> </p> <p>ESP<sup>®</sup> or traction control has intervened because there is a risk of skidding or at least one wheel has started to spin. Cruise control or DISTRONIC is deactivated.</p> <ul style="list-style-type: none"> <li>► Only depress the accelerator pedal as far down as necessary when pulling away.</li> <li>► Release the accelerator pedal while the vehicle is in motion.</li> <li>► Adapt your driving style to suit the road and weather conditions.</li> <li>► Do not deactivate ESP<sup>®</sup>.</li> </ul> <p>Exceptions: (► page 66).</p>
<p>  </p> <p>The yellow ESP<sup>®</sup> warning lamp flashes while the vehicle is in motion.</p>	<p>At least one wheel is spinning and ETS (Electronic Traction System) is deactivated to prevent the brakes on the drive wheels from overheating.</p> <ul style="list-style-type: none"> <li>► Observe the additional display messages in the multifunction display.</li> </ul> <p>ETS switches back on again as soon as the brakes have cooled down.</p> <p>The display message disappears and the  warning lamp goes out.</p>



Problem	Possible causes/consequences and ► Solutions
 The yellow ESP® warning lamp is lit while the engine is running.	 <b>Risk of accident</b> ESP® and ESP® trailer stabilization are deactivated. ESP® will not stabilize the vehicle if it starts to skid or if a wheel starts to spin. <ul style="list-style-type: none"> <li>► Reactivate ESP®. Exceptions: (► page 66).</li> <li>► Adapt your driving style to suit the road and weather conditions.</li> </ul> If ESP® cannot be activated: <ul style="list-style-type: none"> <li>► Have ESP® checked at a qualified specialist workshop.</li> </ul>
 The yellow ESP® warning lamp is lit while the engine is running.	 <b>Risk of accident</b> ESP® is not available due to a malfunction. ESP® will not stabilize the vehicle if it starts to skid or if a wheel starts to spin. The brake system continues to function normally, but without the functions listed above. <ul style="list-style-type: none"> <li>► Observe the additional display messages in the multifunction display.</li> <li>► Drive on carefully.</li> <li>► Visit a qualified specialist workshop.</li> </ul>
 The red SRS warning lamp is lit while the engine is running.	 <b>Risk of injury</b> The restraint systems are malfunctioning. The air bags or Emergency Tensioning Devices may either be triggered unintentionally or, in the event of an accident, not be triggered at all. <ul style="list-style-type: none"> <li>► Drive on carefully.</li> <li>► Visit a qualified specialist workshop immediately.</li> </ul>



 **Warning**

In the event a malfunction of the SRS is indicated as outlined above, the SRS may not be operational.

For your safety, we strongly recommend that you contact an authorized Mercedes-Benz Center immediately to have the system checked. Otherwise the SRS may not be activated when needed in an accident, which could result in serious or fatal injury, or it might deploy unexpectedly and unnecessarily which could also result in injury.

Engine	
Problem	Possible causes/consequences and ► Solutions
<p> (USA only)   (Canada only)</p> <p>The yellow engine diagnostics warning lamp lights up while the engine is running.</p>	<p>There may be a malfunction, for example:</p> <ul style="list-style-type: none"> <li>• in the engine management</li> <li>• in the fuel injection system</li> <li>• in the exhaust system</li> <li>• in the ignition system (for vehicles with gasoline engines)</li> </ul> <p>The emission limit values may have been exceeded and the engine may be breaking in emergency mode.</p> <p>► Have the vehicle checked as soon as possible at a qualified specialist workshop.</p> <p><b>i</b> In some states, you are required to visit a qualified specialist workshop as soon as the yellow engine diagnostics warning lamp lights up due to the relevant applicable legislation. If necessary, check whether this is the case in the state you are in.</p>
<p> (USA only)   (Canada only)</p> <p>The yellow engine diagnostics warning lamp lights up while the engine is running.</p>	<p>The fuel system pressure is too low. The fuel filler cap is not closed correctly or the fuel system is leaking.</p> <p>► Check that the fuel filler cap is correctly closed.</p> <p>► <b>If the fuel filler cap is not correctly closed:</b> close the fuel filler cap.</p> <p>► <b>If the fuel filler cap is closed:</b> visit a qualified specialist workshop.</p>
	<p>Vehicles with a diesel engine: the fuel tank has been run completely dry and the engine will not start. There is air in the fuel system (► page 155).</p>
<p>The yellow reserve fuel warning lamp lights up while the engine is running.</p>	<p>The fuel level has fallen below the reserve range.</p> <p>The fuel tank must be filled at least to the reserve fuel level to prevent impairment to the running of the engine.</p> <p>► Refuel at the nearest gas station.</p>

Driving systems	
Problem	Possible causes/consequences and ► Solutions
 <p>The red DTR distance warning lamp lights up while the vehicle is in motion. A warning tone also sounds.</p>	<p> <b>Risk of accident</b></p> <p>A warning is issued if:</p> <ul style="list-style-type: none"> <li>• you are approaching a vehicle in front at too great a speed</li> <li>• DISTRONIC has detected a stationary obstacle in your line of travel</li> </ul> <p>► Be prepared to brake immediately.</p> <p>► Pay careful attention to the traffic situation. You may have to brake or take evasive action.</p>

Tires	
Problem	Possible causes/consequences and ► Solutions
 <p>USA only: The yellow combination low tire pressure telltale/TPMS malfunction telltale for the TPMS is on.</p>	<p> <b>Risk of accident</b></p> <p>The TPMS has detected a loss of pressure in at least one of the tires.</p> <ul style="list-style-type: none"> <li>► Stop the vehicle without making any sudden steering or braking maneuvers. Pay attention to the traffic conditions as you do so.</li> <li>► Observe the additional display messages in the multifunction display.</li> <li>► Check the tire pressure. If necessary, correct the tire pressure (▷ page 331).</li> <li>► If necessary, change a wheel (▷ page 340).</li> </ul>
 <p>USA only: The yellow combination low tire pressure telltale/TPMS malfunction telltale for the TPMS flashes for 60 seconds and then remains illuminated.</p>	<p>The TPMS is faulty.</p> <ul style="list-style-type: none"> <li>► Observe the additional display messages in the multifunction display.</li> <li>► Visit a qualified specialist workshop.</li> </ul>

### **Warning**

Each tire, including the spare (if provided), should be checked every other week when cold and inflated to the inflation pressure recommended by the vehicle manufacturer on the Tire and Loading Information placard on the driver's door B-pillar or, if available, the tire inflation pressure label on the inside of the fuel filler flap. If your vehicle has tires of a different size than the size

indicated on the Tire and Loading Information placard or, if available, the tire inflation pressure label, you should determine the proper tire inflation pressure for those tires.

As an added safety feature, your vehicle has been equipped with a tire pressure monitoring system (TPMS) that illuminates a low tire pressure warning lamp when one or more of your tires are significantly underinflated. Accordingly, when the low tire pressure warning lamp illuminates, you should stop and check your tires as soon as possible, and inflate them to the proper pressure. Driving on a significantly underinflated tire causes the tire to overheat and can lead to tire failure.

Underinflation also reduces fuel efficiency and tire tread life, and may affect the vehicle's handling and stopping ability. Please note that the TPMS is not a substitute for proper tire maintenance, and it is the driver's responsibility to maintain correct tire pressure, even if underinflation has not reached the level to trigger illumination of the TPMS low tire pressure warning lamp.

Your vehicle has also been equipped with a TPMS malfunction indicator to indicate when the system is not operating properly. The TPMS malfunction indicator is combined with the low tire pressure warning lamp. When the system detects a malfunction, the warning lamp will flash for approximately one minute and then remain continuously illuminated. This sequence will continue upon subsequent vehicle start-ups as long as the malfunction exists. When the malfunction indicator is lit, the system may not be able to detect or signal low tire pressure as intended.

TPMS malfunctions may occur for a variety of reasons, including the installation of incompatible replacement or alternate tires or wheels on the vehicle that prevent the TPMS from functioning properly. Always check the TPMS malfunction warning lamp after replacing one or more tires or wheels on your vehicle to ensure that the replacement or alternate tires and wheels allow the TPMS to continue to function properly.

Vehicle equipment .....	256
Loading guidelines .....	256
Stowage compartments .....	256
Stowage areas .....	258
Features .....	265

## Vehicle equipment

**i** This manual describes all the standard and optional equipment of your vehicle which was available at the time of purchase. Country-specific differences are possible. Bear in mind that your vehicle may not feature all functions described here. This also refers to safety-related systems and functions.

## Loading guidelines

### Warning!

Always fasten items being carried as securely as possible. Use cargo tie-down rings and fastening materials appropriate for the weight and size of the load.

In an accident, during hard braking or sudden maneuvers, loose items will be thrown around inside the vehicle. This can cause injury to vehicle occupants unless the items are securely fastened in the vehicle.

To help avoid personal injury during a collision or sudden maneuver, exercise care when transporting cargo. Do not pile luggage or cargo higher than the seat backrests.

The cargo compartment is the preferred place to carry objects. Always use cargo tie-down rings, and if so equipped, always use the cargo net when transporting cargo.

Never drive a vehicle with the tailgate open. Deadly carbon monoxide (CO) gases may enter vehicle interior resulting in unconsciousness and death.

The gross vehicle weight (GVW) is the weight of the vehicle including fuel, the vehicle tool kit, spare tire, any installed accessories, vehicle occupants and luggage/cargo.

The load limit and the gross vehicle weight rating (GVWR) of your vehicle must never be exceeded. The load limit and the GVWR are stated on the vehicle identification plate on

the B-pillar on the driver's side (▷ page 334).

Additionally, the cargo must be distributed so that the weight on each axle never exceeds the maximum gross axle weight rating (GAWR) for the front and rear axles. The data on GVWR and GAWR is stated on the vehicle identification plate on the B-pillar on the driver's side (▷ page 334).

Further information can be found in the "Loading the vehicle" section (▷ page 334).

The handling characteristics of a laden vehicle are dependent on the distribution of the load within the vehicle. For this reason, you should observe the following notes when transporting a load:

- Position heavy loads as far forwards as possible and as low down in the cargo compartment as possible.
- The load must not protrude above the upper edge of the seat backrests.
- always place the load against the rear or front seat backrests. Make sure that the seat backrests are securely locked into place.
- Hook in the cargo net when loading.
- Always place the load behind unoccupied seats if possible.
- Secure the load with sufficiently strong and wear-resistant tie down. Pad sharp edges for protection.

## Stowage compartments

### Important safety guidelines

#### Warning!

To help avoid personal injury during a collision or sudden maneuver, exercise care when storing objects in the vehicle. Put luggage or cargo in the cargo compartment if possible. Do not pile luggage or cargo higher than the seat backrests.

If so equipped, always use the cargo net when transporting cargo. The cargo net cannot secure hard or heavy objects.

Parcel nets cannot secure hard or heavy objects.

Keep compartment lids closed. This will help to prevent stored objects from being thrown about and injuring vehicle occupants during

- braking
- vehicle maneuvers
- an accident

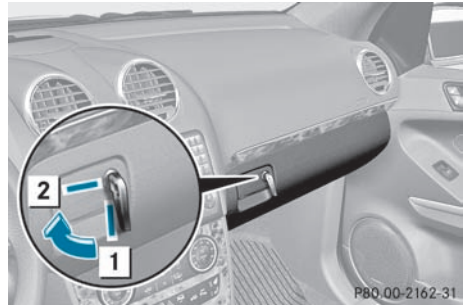

- 1 glove box unlocked
- 2 glove box locked

## Stowage compartments in the front

### Glove box

**i** Depending on the vehicle equipment, there is an AUX-IN connection or a Media Interface installed in the glove box. Media Interface is a universal interface for mobile audio equipment, e.g. for an iPod® or USB devices; see separate COMAND APS operating instructions.

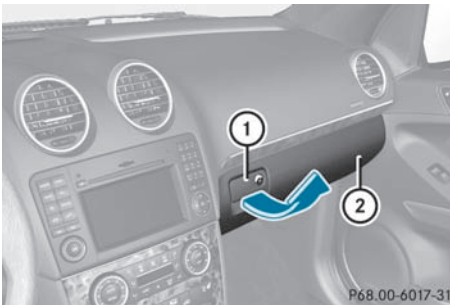

- ▶ **To open:** pull handle ① and open glove box flap ②.
- ▶ **To close:** fold glove box flap ② upwards until it engages.

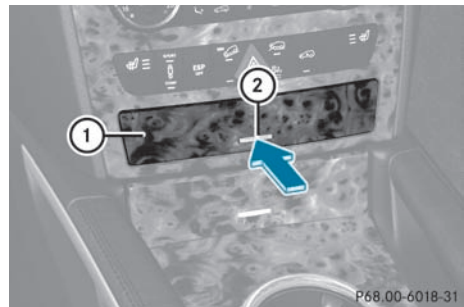

The glove box can only be locked and unlocked using the mechanical key.

## Stowage compartments in the center console



- ▶ **To open:** briefly press marking ②.
- ▶ **To close:** push stowage compartment ① in the direction of the arrow until it engages.

## Stowage compartment under the armrest

- i** The Roadside Assistance  (▷ page 272) and MB info call  (▷ page 273) buttons are located in the stowage compartment under the armrest.

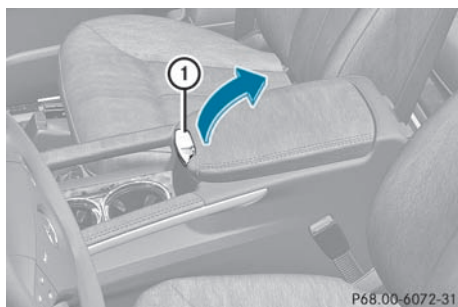

- **To open:** pull handle ① and fold the armrest upwards.

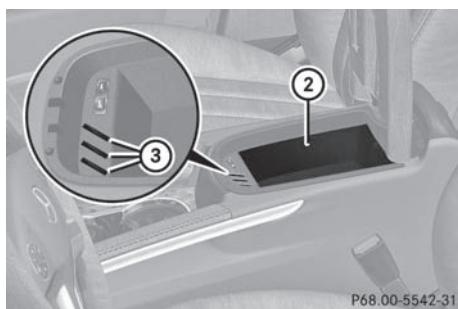

Coin holder ③ is located in front of stowage compartment ②.

## Storage compartments in the rear

### Stowage compartment in the rear center console

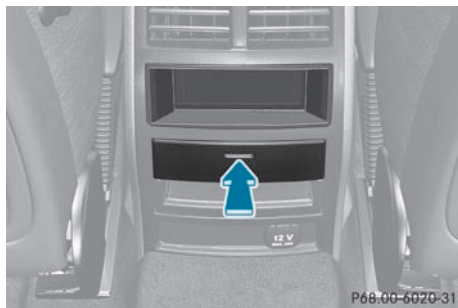

- **To open:** press lightly on the top of the stowage compartment. The stowage compartment moves out automatically.

## Stowage areas

### Parcel nets

#### **Warning!**

Vehicles with Occupant Classification System (OCS)

Do not place objects with a combined weight of more than 4.4 lbs (2 kg) into the parcel net on the back of the front passenger seat. Otherwise, the OCS may not be able to properly approximate the occupant weight category.

#### **Warning!**

Parcel nets are intended for storing light-weight items only, such as road maps, mail, etc.

Heavy objects, objects with sharp edges, or fragile objects may not be transported in the parcel nets. In an accident, during hard braking, or sudden maneuvers, they could be thrown around inside the vehicle and cause injury to vehicle occupants.

Parcel nets cannot protect transported goods in the event of an accident.

Parcel nets are located in the front-passenger footwell and on the back of the driver's and the front-passenger seats.

### Enlarging the luggage compartment

### Important safety guidelines

#### **Warning!**

When expanding the cargo volume, always fully fold the corresponding seats and, if so equipped, always use the cargo net when transporting cargo.

Unless you are transporting cargo, the seat backrests must remain properly locked in the upright position.

In an accident, during hard braking or sudden maneuvers, loose items will be thrown around inside the vehicle. This can cause injury to

vehicle occupants unless the items are securely fastened in the vehicle. Always use the cargo tie-down rings.

**Warning!**

Never drive a vehicle with the tailgate open. Deadly carbon monoxide (CO) gases may enter vehicle interior resulting in unconsciousness and death.

- ❗ Release and fold the seat cushion upwards before folding the rear bench seat forward. Otherwise, the backrests may be damaged.

When the backrest is folded forwards, the front seats cannot be moved to their rearmost position. Otherwise, the front seats and the rear bench seat could be damaged.

The left-hand and right-hand rear seat backrests can be folded forwards separately to increase the cargo compartment capacity.

**Folding the rear bench seat forward**

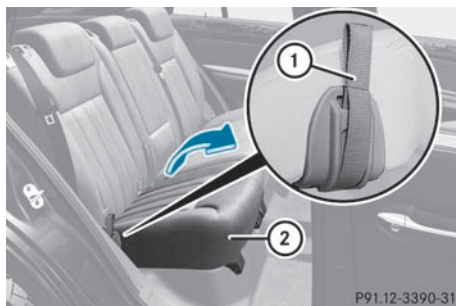

- i If the driver's or front-passenger seat is set for a larger person, it may not be possible to fold the rear bench seat forwards. In this case, move the front seats as far forward as possible.
- ▶ Move the head restraints to the lowest position (▷ page 96).
- ▶ Pull release loop (1) of seat cushion (2). Seat cushion (2) is released.
- ▶ Fold seat cushion (2) upwards.

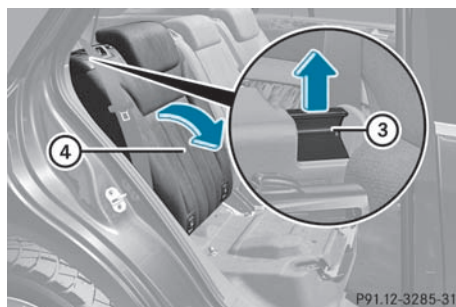

- ▶ Pull release lever (3) on left or right backrest (4) in the direction of the arrow. Red safety tab (5) appears and seat backrest (4) is unlocked.

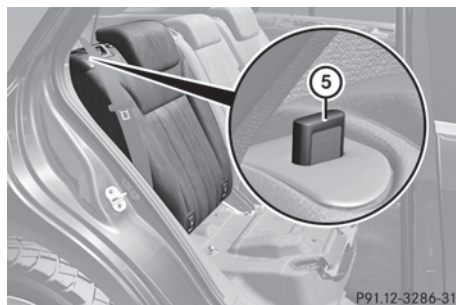

- ❗ The backrest is heavy. Therefore, take care when folding it down. Make sure that the head restraints are pushed all the way in so that the backrests and seat cushions are not damaged.
- ▶ Fold backrest (4) forwards until it engages in the cargo compartment position.

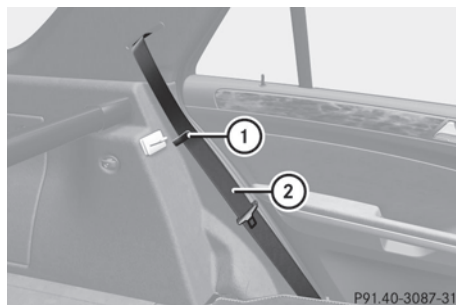

- ▶ Guide seat belts (2) under respective clips (1).

### Folding the rear bench seat back

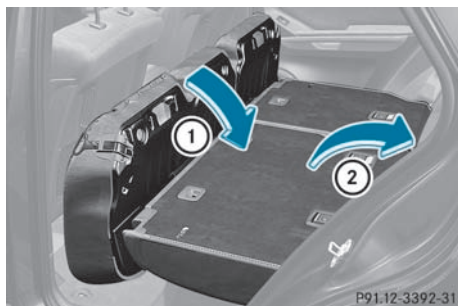

- ▶ Fold backrest ② backwards until it engages, making sure not to trap the seat belts while doing so. The red safety tab is no longer visible.
- ▶ Fold seat cushion ① backwards and push until you hear it engage.
- ▶ Pull up and adjust the head restraints if necessary (▶ page 96).

#### Warning!

If a red indicator is visible with the seat backrest up, then the seat backrest is not properly locked into position.

Always lock seat backrest in its upright position when the rear seats are occupied, or the extended cargo compartment is not in use. Check for secure locking by pushing and pulling on the seat backrest.

### Securing cargos

#### Lashing eyelets

Observe the following notes on securing loads:

- secure the load using the cargo tie down rings.
- do not use elastic straps or nets to secure a load, as these are only intended as an anti-slip protection for light loads.
- do not route tie downs across sharp edges or corners.
- pad sharp edges for protection.

### Footwell of the 2nd row of seats

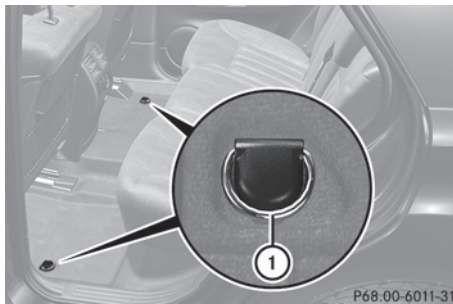

There is one cargo tie-down ring ① in the footwell behind the driver's seat and one in the footwell behind the front-passenger seat.

### Cargo compartment

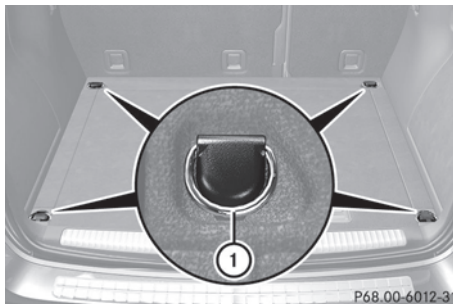

There are four cargo tie down rings ① in the cargo compartment.

### Mounting hooks

Only use the mounting hooks to secure items of luggage up to maximum of 9 lbs (4 kg) in weight.

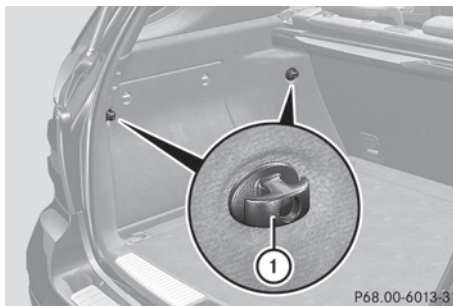

There are two securing hooks ① on each side of the cargo compartment.

### Luggage compartment cover

#### Important safety guidelines

❗ When loading the vehicle, make sure that you do not stack the load in the cargo compartment higher than the lower edge of the side windows. Do not place heavy objects on top of the cargo compartment cover.

The cargo compartment cover is located behind the rear bench seat backrest.

#### Extending/retracting the luggage compartment cover

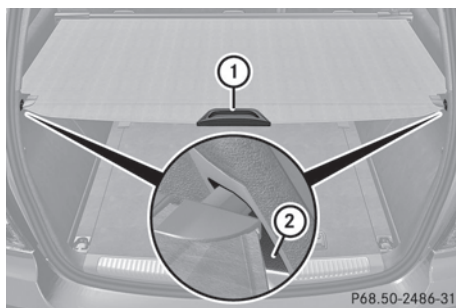

- ▶ **To extend:** pull the cargo compartment cover back by grab handle ① and clip it into retainers ② on the left and right.
- ▶ **To retract:** unhook the cargo compartment cover from retainers ② on the left and right and guide it forwards by grab handle ① until it is fully retracted.

#### Removing/installing the luggage compartment cover

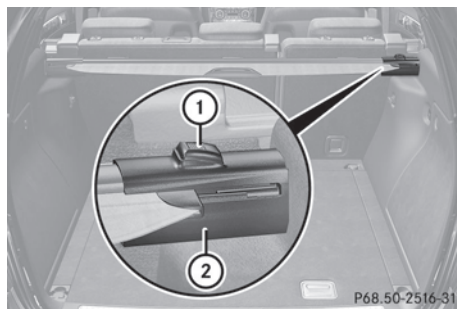

- ▶ **To remove:** make sure that cargo compartment cover ② is rolled up.
- ▶ Press button ①.
- ▶ Move cargo compartment cover ② to the left.
- ▶ Remove cargo compartment cover ②.
- ▶ **To install:** with the handle of the cargo compartment pointing to the rear and button ① facing upwards, insert cargo compartment cover ② into the recess of the side trim on the left-hand side.
- ▶ Guide cargo compartment cover ② in front of the recess on the right.
- ▶ Press button ① and insert the right-hand side section into the recess of the side trim.

### Cargo net

#### Important safety guidelines

##### ⚠ Warning!

Make sure the cargo net is properly engaged at top and bottom position and the tightening belts are securely fastened.

Never use a damaged cargo net.

Always use cargo net when transporting cargo. This helps to avoid personal injury from smaller objects being thrown around in the occupant compartment during a collision or sudden maneuver.

The cargo net cannot prevent the movement of large, heavier objects into the passenger compartment in an accident. Such items must be properly secured using the cargo tie-down rings in the cargo compartment floor.

Passenger use of seats behind installed cargo net is restricted because of the footwell being taken up by the net.

When the vehicle is loaded with objects that extend beyond the seat backrests, using a cargo net is particularly important. For reasons of safety, a cargo net should always be used when transporting cargo.

### Preparing the cargo net

The cargo net can be used in two different positions (behind the B-pillar or the C-pillar).



- The brackets behind B-pillar ① are required for the cargo compartment enlargement (▷ page 258).  
The corresponding cargo tie down rings to tighten the net are located in the footwell of the rear bench seat (▷ page 260).
- The brackets behind C-pillar ② are required for the cargo compartment behind the rear bench seat.  
The corresponding cargo tie down rings to tension the net are located in the cargo compartment (▷ page 260).

- ▶ Undo the two Velcro fasteners of the safety-net stowage.
- ▶ Unroll and unfold the cargo net.  
The upper and lower guide rods must engage audibly.

### Attaching the cargo net

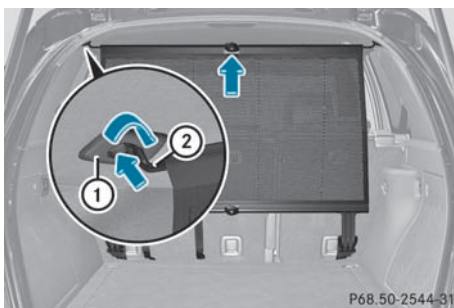

Cargo net attached behind the C-pillar

- ▶ Insert guide rod ② into retainer ① in the direction of the arrow.
- ▶ Slide guide rod ② forwards into retainer ① in the direction of the arrow.

### Tightening the cargo net

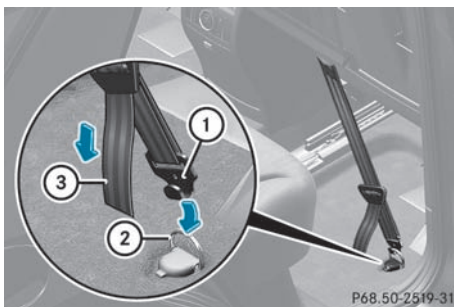

Seat belt reel holder behind the front seats

- ▶ Insert belt hook ① into cargo tie-down ring ② in the direction of the arrow.
- ▶ Pull tensioning strap ③ by the loose end in the direction of the arrow until the cargo net is tight.
- ▶ After driving a short distance, check the tension of the cargo net and retighten it if necessary.

### Releasing the cargo net

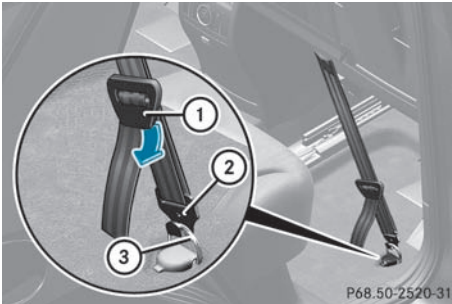

Seat belt reel holder behind the front seats

- ▶ Pull belt adjuster ① upwards in the direction of the arrow to reduce the tension on the tensioning strap.
- ▶ Unhook belt hook ② from cargo tie-down ring ③.

### Detaching and storing the cargo net

- ▶ Detach guide rod ② from bracket ① (> page 262).
- ▶ Press the red button on the upper and lower guide rods.
- ▶ Fold the cargo net and roll it up.
- ▶ Close the two Velcro fasteners on the cargo net holder.

## EASY-PACK load-securing kit

### Components and stowage

The EASY-PACK load-securing kit allows you to use your cargo compartment for a variety of purposes. You can keep the EASY-PACK load-securing kit in the bag supplied and store it together with the telescopic rod under the trunk floor.

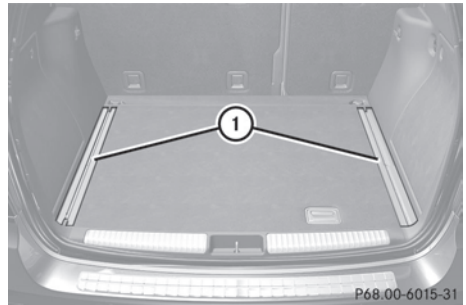



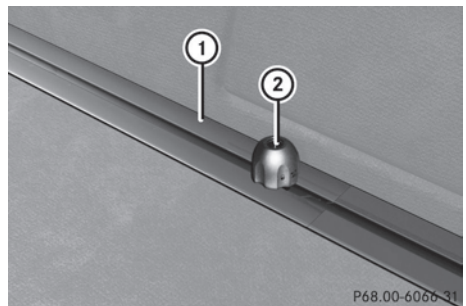

① Loading rails



### Inserting the mounting elements into the loading rail



You can slide mounting element ② in loading rail ① to various detents and secure it. These detents are marked and positioned at 5-cm intervals along loading rail ①.

You can turn mounting element ② of loading rail ① to four positions:

-  To lock the mounting element
-  To release the cargo tie-down ring, the inertia reel or the telescopic rod
-  To remove the mounting element
-  To push the mounting element to the next detent

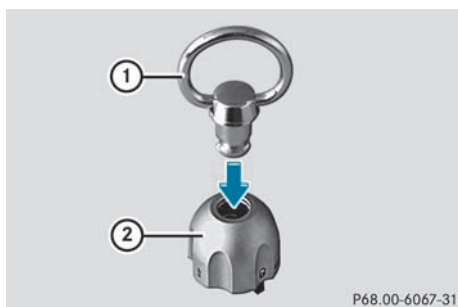

- ▶ Turn mounting element ② to .
- ▶ Insert mounting element ② into loading rail ①.
- ▶ Turn mounting element ② to  until you feel it clearly engage in loading rail ①.

## Inserting the lashing eyelets into the mounting



### ⚠ Warning!

Distribute the load on the cargo tie down rings evenly. Please observe the loading guidelines.

- ▶ Turn mounting element ② in the loading rail to .
- ▶ Insert cargo tie-down ring ① into mounting element ②.
- ▶ Turn mounting element ② to  until you feel it clearly engage in the loading rail.

## Belt retractor

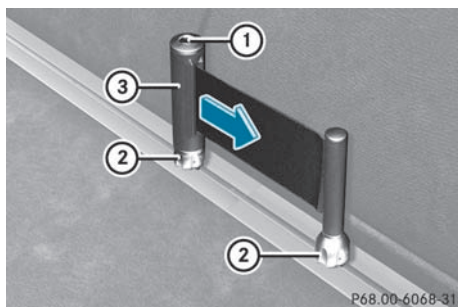

The inertia reel can be used to secure light loads against the side wall of the cargo compartment to prevent them from moving around.



- ▶ Insert two mounting elements ② into a loading rail.
- ▶ Turn mounting elements ② in the loading rail to .

- ▶ Insert inertia reel ③ into mounting elements ②.
- ▶ Turn mounting element ② to  until you feel it clearly engage in the loading rail.
- ▶ Press unlocking button ① on inertia reel ③ and pull the cargo net out in the direction of the arrow.
- ▶ Place the load between the securing net and the cargo compartment side wall.
- ▶ Using one hand, press locking button ① of inertia reel ③.
- ▶ With your other hand, slowly extend the net around the load until it is secure.

## Telescopic rod

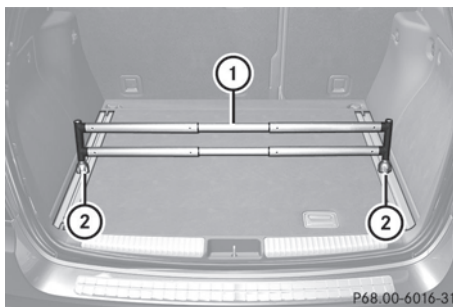
The telescopic rod can be used to secure the load against the rear seats to prevent it from moving around.



- ▶ Insert one mounting element ② into each loading rail.
- ▶ Turn mounting elements ② in the loading rail to .
- ▶ Insert telescopic rod ① into mounting elements ②.
- ▶ Turn mounting element ② to  until you feel it clearly engage in the loading rail.

**Roof carrier**

**Important safety guidelines**

**Warning!**

Only use carriers when the basic carrier bars have been completely mounted. The left and right roof rails are only stabilized by means of the basic carrier bars mounted.

Follow the manufacturer's installation instructions. Otherwise, an improperly attached carrier or its load could become detached from the vehicle.

Do not exceed the maximum roof load of 220 lb (100 kg).

Take into consideration that when the roof is loaded, the handling characteristics are different from those when operating the vehicle without the roof loaded.

**!** Mercedes-Benz recommends that you only use roof carriers that have been tested and approved for Mercedes-Benz vehicles. This helps to prevent damage to the vehicle.

Position the cargo on the roof rack in such a way that the vehicle will not sustain damage even when it is in motion.

Depending on the vehicle equipment, ensure that when the roof carrier is installed you can:

- raise the tilt/sliding sunroof fully
- open the tailgate fully

**Fastening the roof carrier**



- ▶ Secure the roof carrier to roof rails ①.
- ▶ Observe the manufacturer's installation instructions.

**Features**

**Cup holder**

**Points to observe before use**

**Warning**

In order to help prevent spilling liquids on vehicle occupants and/or vehicle equipment, only use containers that fit into the cup holder. Use lids on open containers and do not fill containers to a height where the contents, especially hot liquids, could spill during braking, vehicle maneuvers, or in an accident. Liquids spilled on vehicle occupants may cause serious personal injury. Liquids spilled on vehicle equipment may cause damage not covered by the Mercedes-Benz Limited Warranty.

When not in use, keep the cup holder closed. An open cup holder may cause injury to you or others when contacted during braking, vehicle maneuvers, or in an accident.

Keep in mind that objects placed in the cup holder may come loose during braking, vehicle maneuvers, or in an accident and be thrown around in the vehicle interior. Objects thrown around in the vehicle interior may cause an accident and/or serious personal injury.

**Cup holder in the center console**

In the upper center console, there is a cup holder and a removable support with a card holder

You can remove the cup holder to clean it. Clean the cup holder with clear, lukewarm water only.

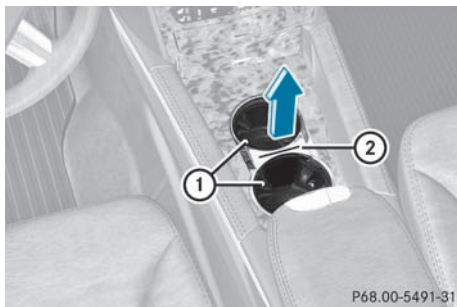

- ▶ **To remove:** hold cup holder ① by support ② and pull out in the direction of the arrow.
- ▶ **To install:** place the cup holder into the guides and insert.

### Cup holder in the rear seat armrest

❗ Do not sit or lean your bodyweight on the armrests when they are folded out as you could damage them.



- ▶ Fold down the armrest.

### Sun visors

#### ⚠ Warning

Do not use the vanity mirror while driving. Keep the vanity mirrors in the sun visors closed while the vehicle is in motion. Reflected glare can endanger you and others.

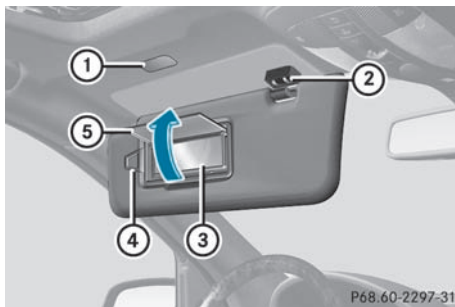

- ① Mirror light
- ② Bracket
- ③ Vanity mirror
- ④ Retaining clip, e.g. for a car park ticket
- ⑤ Mirror cover

### Vanity mirror in the sun visor

Mirror light ① only functions if the sun visor is clipped into retainer ② and mirror cover ⑤ has been folded up.

### Glare from the side

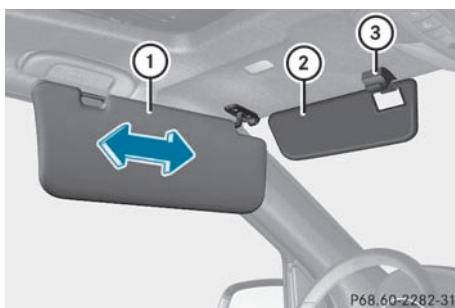

- ▶ Fold down sun visor ①.
- ▶ Pull sun visor ① out of retainer ③.
- ▶ Swing sun visor ① to the side.
- ▶ **Vehicles with a sliding sunroof:** slide sun visor ① horizontally as desired.
- ▶ **Vehicles with a sliding sunroof:** fold down additional sun visor ② to the windshield.

## Ashtray

### Ashtray in the cockpit

- i** There is a stowage space under the ashtray.
- !** The stowage space under the ashtray is not heat resistant. Before placing lit cigarettes in the ashtray, make sure that the ashtray is properly engaged. Otherwise, the stowage space could be damaged.

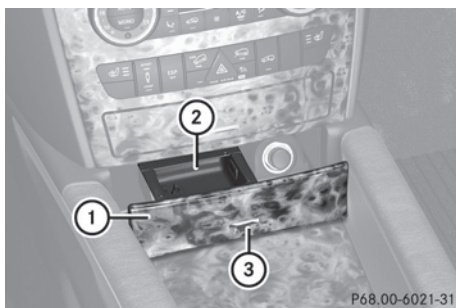

- ▶ To open:** briefly press marking ③. Ashtray ① opens.
- ▶ To remove the insert:** lift insert ② up and out.
- ▶ To refit the insert:** press insert ② into the holder until it engages.

### Ashtray in the rear compartment

- !** Close the ashtray when it is not in use and before you fold the rear seats forward. You can otherwise damage the ashtray.

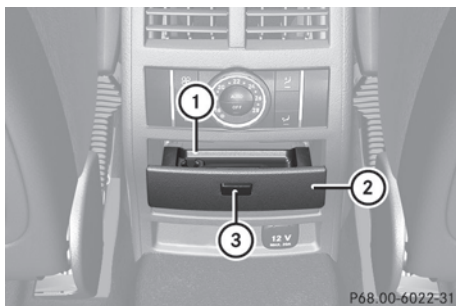

- ▶ To open:** briefly press marking ③. Ashtray ② opens.
- ▶ To remove the insert:** lift insert ① up and out.
- ▶ To re-insert the insert:** replace insert ① from above.
- ▶ Press insert ① into the holder until it engages.**

## Cigarette lighter

### Warning

When leaving the vehicle, always remove the SmartKey from the ignition lock. Always take the SmartKey with you and lock the vehicle. Do not leave children unattended in the vehicle, even if they are secured in a child restraint system, or with access to an unlocked vehicle. A child's unsupervised access to a vehicle could result in an accident and/or serious personal injury. The children could:

- injure themselves on parts of the vehicle
- be seriously or fatally injured through excessive exposure to extreme heat or cold
- injure themselves or cause an accident with vehicle equipment that can be operated even if the SmartKey is removed from the ignition lock or removed from the vehicle, such as seat adjustment, steering wheel adjustment, or the memory function

If children open a door, they could injure other persons or get out of the vehicle and injure themselves or be injured by following traffic. Do not expose the child restraint system to direct sunlight. The child restraint system's metal parts, for example, could become very hot, and the child could be burned on these parts.

### Warning

Never touch the heating element or sides of the lighter; they are extremely hot. Hold the knob only.

Make sure any children traveling with you do not injure themselves or start a fire with the hot cigarette lighter.

- !** The 12 V socket in the cigarette lighter can be used for accessories (up to a maximum of 180 W) as long as they have the standard socket type for cigarette lighters. Note that the socket in the cigarette lighter can be damaged when connecting accessories, for example by frequent insertion and removal or by sockets that do not fit correctly. A damaged socket can cause the cigarette lighter to stop working.

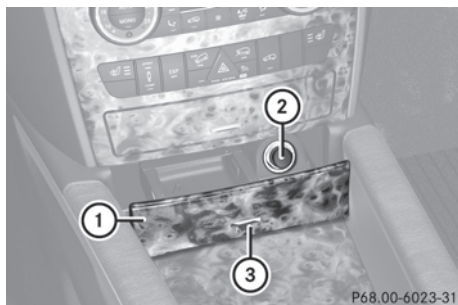

Center console, front

- ▶ Turn the key to position **2** in the ignition lock.
- ▶ Press marking **3**.  
Ashtray **1** opens.
- ▶ Press in cigarette lighter **2**.  
Cigarette lighter **2** will pop out automatically when the heating element is red-hot.

## 12 V sockets

### Points to observe before use

- !** If you are using all sockets in the vehicle, make sure that you do not exceed the maximum current draw of 55 A. Otherwise, you will overload the fuses.
- !** Only use the 12 V socket on the center console to connect the electric air pump.

You could otherwise damage the vehicle's electrics.

The socket can be used for accessories with a maximum power consumption of 180 W, e.g. lamps or chargers for mobile phones.

If you use the socket for long periods when the engine is switched off, the battery may discharge.

- ▶ Turn the key to position **2** in the ignition lock.

### Socket in the front-passenger footwell



- ▶ Lift up the cover of socket **1**.

### Socket in the cockpit

**!** If accessories are connected, make sure that a maximum current draw of 15 A is not exceeded. Otherwise, you will overload the fuse.

**!** The socket is not suitable for operating the electric air pump.

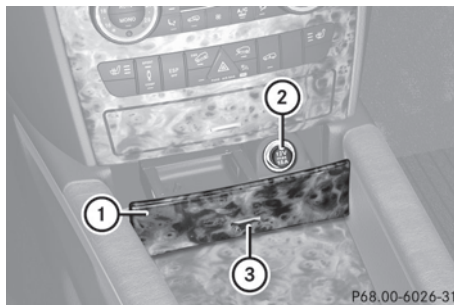

- ▶ Press marking ③.  
Stowage compartment ① opens.
- ▶ Remove cover from socket ②.
- i** On vehicles with the smoker's package, you must remove the cigarette lighter in order to use the socket (▶ page 267).

### Socket in the rear compartment

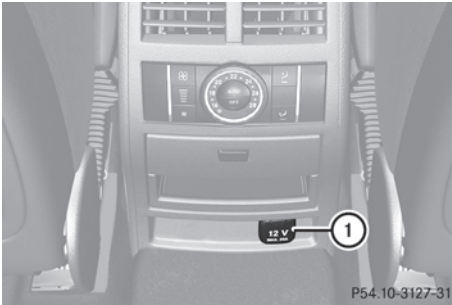

- ▶ Lift up the cover of socket ①.

### Socket in the cargo compartment

The socket is located in the cargo compartment on the right-hand side trim.

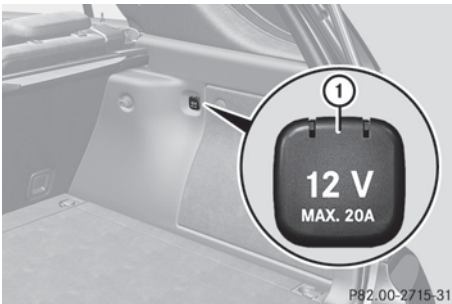

- ▶ Lift up the cover of socket ①.
- i** You can also use the socket when the ignition is switched off. An emergency cut-out ensures that the on-board voltage does not drop too low. If the on-board voltage is too low, the power to the sockets is automatically cut. This ensures that there is sufficient power to start the engine.

### 115 V socket

#### **Warning!**

The 115V AC socket operates at high voltage. Use the 115V AC socket in the vehicle with the same caution and prudence that you exercise when using power outlets at home. Keep any fluids away from the 115V AC socket. Do not clean the socket with fluids or tapered objects. Keep the 115V AC socket cover in the closed position, when not in use. Otherwise, you could suffer an electric shock and be seriously or even fatally injured.

#### **Warning!**

A device that you connect must have a suitable plug that complies with U.S. standards. Never pull on the cable to unplug a plug from the 115V AC socket. Do not use a damaged connection cable. The 115V AC socket may not be connected to another 115V AC power source. Do not use converters to a grounding plug with the 115V AC socket. This could cause serious personal injury to you and/or others.

#### **Warning!**

If the 115V AC socket is damaged or torn out of the trim, do not use or touch the 115V AC socket. Using a 115V AC socket that is damaged or torn out of the trim could cause serious personal injury to you and/or others.

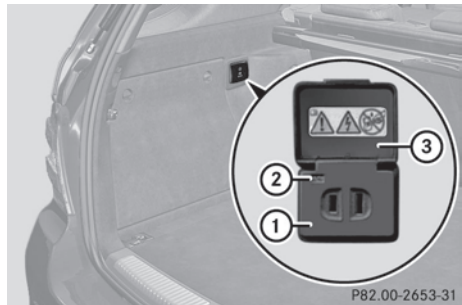

The 115 V AC power socket ① provides an alternating voltage of 115 V, so that small electronic devices can be connected. These

devices, such as games consoles, chargers and laptops, should not consume more than a maximum of 150 W altogether.

Requirements for operation of these devices:

- 12 V power sockets in the footwell of the second row of seats and in the stowage compartment must be functioning correctly (▷ page 268).
  - the plug of the electronic device is plugged into the 115 V power socket ①.
  - the on-board voltage is within a permissible voltage range.
  - the maximum wattage of the device to be connected must not exceed 150 W.
- ▶ Open flap ③.
- ▶ Insert the plug of the electrical device into the 115 V power socket ①.  
Indicator lamp ② lights up.

If indicator lamp ② does not light up, please read the chapter on malfunctions.

- ▶ **To turn off:** disconnect the plug from the 115 V power socket ①.  
Ensure that you do not pull on the cord.
- ▶ Close flap ③.

Possible causes of malfunction:

- the on-board voltage of the vehicle is not within the permissible voltage range.
- the temperature of the DC/AC converter is momentarily too high.
- some small electronic devices have a constant nominal power of less than 150 W, but a very high inrush current.  
These devices will not work. If you connect such a device, the 115 V power socket ① will not supply it with power.

If indicator lamp ② still does not light up, consult a specialist workshop, e.g. an authorized Mercedes-Benz Center.

## mbrace<sup>38</sup>

### Important safety guidelines

**!** A license agreement must exist in order to activate the mbrace service. Make sure that your system is activated and ready for use, and press the  MB info call button to register. If you cannot carry out any of the steps mentioned, the system may not be activated.

If you have any questions concerning activation, please contact one of the following service hotlines:

- **USA:** Response Center under 866-990-9007
- **Canada:** Customer Service under 1-888-923-8367

Shortly after successfully registering with the mbrace service, a user ID and password will be sent to you by post. You can use this password to log in to the mbrace section under "Owners Online" at <http://www.mbusa.com><sup>39</sup>.

The mbrace system is available if:

- it has been activated and is operational.  
Activation requires an available cellular phone network, a valid SIM card and a service subscription to a surveillance service provider.
  - the battery is sufficiently charged.
  - the corresponding cellular phone network is available for transmitting data to the customer center.
- i** Determining the location of the vehicle on a map is only possible if there is sufficient GPS reception and the vehicle position can be forwarded to the customer center.

<sup>38</sup> The system is called TELEAID in Canada.



<sup>39</sup> USA only.

## The mbrace system

The mbrace system provides three different services:

- automatic and manual emergency call
- Roadside Assistance call
- MB info call

To control the volume during an mbrace call, proceed as follows:

▶ Press the  or  button on the multifunction steering wheel.

or

▶ Use the volume controller of the audio system/COMAND.





You can find information and a description of all available features under "Owners Online" at <http://www.mbusa.com><sup>40</sup>

## System self-test

After you have switched on the ignition, the system carries out a self-diagnosis.

### Warning

A malfunction in the system has been detected if any or all of the following conditions occur:

- The indicator lamp in the SOS button does not come on during the system self-test.
- The indicator lamp in Roadside Assistance button  does not come on during the system self-test.
- The indicator lamp in Information button  does not come on during the system self-test.
- The indicator lamp in the SOS button, Roadside Assistance button , or Information button  remains illuminated constantly in red after the system self-test.
- The message Tele Aid Inoperative or Tele Aid Not Activated appears in the

multifunction display after the system self-test.



If a malfunction is indicated as outlined above, the system may not operate as expected. In case of an emergency, help will have to be summoned by other means.

Have the system checked at the nearest authorized Mercedes-Benz Center or contact the following service hotlines:

- **USA:** Response Center under the number 866-990-9007
- **Canada:** Customer Service under 1-888-923-8367

## Emergency call

### Important safety notes

 A license agreement must exist in order to activate the mbrace service. Make sure that your system is activated and ready for use, and press the  MB info call button to register. If you cannot carry out any of the steps mentioned, the system may not be activated.

If you have any questions concerning activation, please contact one of the following service hotlines:

- **USA:** Response Center under 866-990-9007
- **Canada:** Customer Service under 1-888-923-8367

An emergency call is dialed automatically if an air bag or Emergency Tensioning Device is triggered.

 An automatically dialed mbrace emergency call cannot be canceled.

An emergency call can also be dialed manually.

Once the emergency call is in progress, the indicator lamp in the SOS button flashes. The Connecting Call message appears in the multifunction display.

<sup>40</sup> USA only.

COMAND is muted.

Once a connection has been established, the Call Connected message appears in the multifunction display.

All important information on the emergency is compiled, for example:

- current location of the vehicle (as determined by the GPS system)
- vehicle model
- vehicle color
- vehicle identification number

A voice connection between the Response Center and the occupants of the vehicle will be established automatically soon after the emergency call has been initiated. If the vehicle occupants are able to respond, the Response Center will attempt to obtain more detailed information on the emergency.

- ❗ If no vehicle occupant answers, an ambulance is immediately sent to the vehicle.

#### ⚠ Warning

If the indicator lamp in the SOS button is flashing continuously and there was no voice connection to the Response Center established, then the mbrace system could not initiate an emergency call (e.g. the relevant cellular phone network is not available).

The message Call Failed appears in the multifunction display for approximately 10 seconds.

Should this occur, assistance must be summoned by other means.

## Making an emergency call

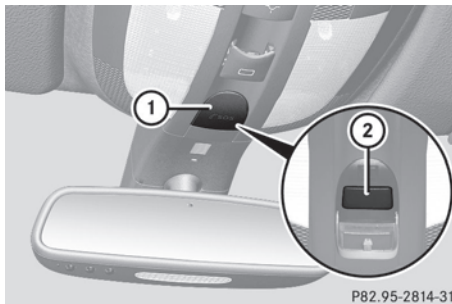

- ▶ **To initiate an emergency call manually:** press cover ① briefly to open.
- ▶ Press SOS button ② briefly. The indicator lamp in SOS button ② flashes until the emergency call is ended.
- ▶ Wait for the voice connection with the Response Center.
- ▶ After the emergency call is ended, close cover ①.

#### ⚠ Warning

If you feel at any way in jeopardy when in the vehicle (e.g. smoke or fire in the vehicle, vehicle in a dangerous road location), please do not wait for voice contact after you have pressed the SOS button. Carefully leave the vehicle and move to a safe location. The Response Center will automatically contact local emergency officials with the vehicle's approximate location if they receive an automatic SOS signal and cannot make voice contact with the vehicle occupants.

## Roadside Assistance call button

- ▶ Open the stowage compartment under the armrest (▷ page 257).

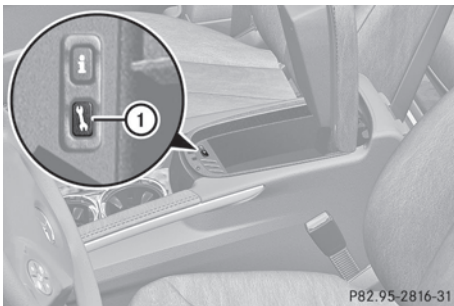

- ▶ Press and hold Roadside Assistance button ① for more than two seconds. A call to a Mercedes-Benz Roadside Assistance Representative is initiated. The indicator lamp in Roadside Assistance button ① flashes while the call is active. The Connecting Call message appears in the multifunction display and COMAND is muted.

If a connection can be established, the Call Connected message appears in the multifunction display.

If a mobile phone network is available and there is sufficient GPS reception, the mbrace system transmits data to the Response Center, for example:

- current location of the vehicle
- vehicle identification number
- vehicle model
- vehicle color

- ❗ The COMAND display shows that an mbrace call is active. You can switch to the navigation menu by pressing the NAVI button on COMAND during the call. Spoken commands are not available.

A voice connection is established between the Mercedes-Benz Roadside Assistance Representative and the vehicle occupants.

- ▶ Describe the type of assistance needed.

The Mercedes-Benz Roadside Assistance Representative either sends a qualified Mercedes-Benz technician or organizes for

your vehicle to be transported to the nearest authorized Mercedes-Benz Center. You may be charged for services such as repair work and/or towing. Further details are available in your mbrace manual.

- ❗ If the indicator lamp in MB info call button ① flashes continuously and it was not possible to establish a voice connection to the Response Center, then the mbrace system has failed to initiate a Roadside Assistance call (e.g. the corresponding cellular phone network is not available). The Call Failed message appears in the multifunction display.

- ▶ **To end a call:** press the  button on the multifunction steering wheel.

or

- ▶ Press the corresponding button for ending a phone call on COMAND.



- ❗ Sign and Drive services<sup>41</sup>: you are not charged for services such as jump-starting, providing a few gallons of fuel for a fuel tank that has been run dry or changing a flat tire with the vehicle's own spare tire.

### MB Info call button

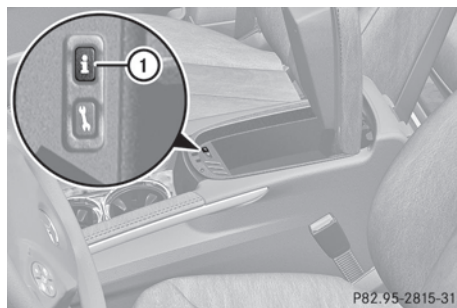
- ▶ The stowage compartment under the armrest (▷ page 257).



<sup>41</sup> USA only.

- ▶ Press and hold MB info call button  for more than two seconds. A call to the Response Center is initiated. MB info call button indicator lamp  flashes while the connection is being established. The Connecting Call message appears in the multifunction display and COMAND is muted.



If a connection can be established, the Call Connected message appears in the multifunction display.

If a mobile phone network is available and there is sufficient GPS reception, the mbrace system transmits data to the Response Center, for example:

- current location of the vehicle
- vehicle identification number
- vehicle model
- vehicle color

 The COMAND display shows that an mbrace call is active. You can switch to the navigation menu by pressing the NAVI button on COMAND during the call. Spoken commands are not available.

A voice connection between the Response Center and the vehicle occupants is established. You can obtain information on how to operate your vehicle's systems, on the location of the nearest authorized Mercedes-Benz Center, and on further products and services offered by Mercedes-Benz USA. Further details on the mbrace system can be found under <http://www.mbusa.com><sup>42</sup>. Log in under "Owners Online".

 If the indicator lamp in MB info call button  flashes continuously and no voice connection to the Response Center has been established, then the mbrace system has failed to initiate an MB info call (e.g. the corresponding mobile phone network is not available). The Call Failed message appears in the multifunction display.

- ▶ **To end a call:** press the  button on the multifunction steering wheel.
- or
- ▶ Press the corresponding button for ending a phone call on COMAND.

### Call priority

---

An emergency call can still be initiated even if a service call is currently active, e.g. the Roadside Assistance call or the MB info call. In this case, an emergency call will take priority and override all other active calls.

The indicator lamp of the respective button flashes until the call is ended. An emergency call can only be ended by the Mercedes-Benz Customer Assistance Center. All other calls can be ended by pressing the  button on the multifunction steering wheel or the corresponding button for ending a telephone call on COMAND.

 When an mbrace call has been initiated, COMAND is muted. The cellular phone is no longer connected to COMAND. If you must use your mobile phone, we recommend that you do this only when the vehicle is stationary and in a safe location.

### Downloading destinations in COMAND

---

 Information on the components and operating principles of COMAND can be found in the separate COMAND operating instructions.

Destination Download gives you access to a database with over 10 million points of interest (POIs) which can be downloaded onto the navigation system of your vehicle. If you know the destination, you can download the address or obtain the location of points of interest (POIs) or important destinations in the surrounding area.

<sup>42</sup> USA only.

You are prompted to confirm route guidance to the entered address.

- ▶ Select Yes using the ◀ button or select ▶ on COMAND.
- ▶ Press the (OK) button on COMAND to confirm.

The system calculates the route and subsequently starts the route guidance with the address entered.

- i** If you select No, the address can be stored in the address book.
- i** The Destination Download function is available if the corresponding cellular phone network is available and data transfer is possible.

### Search & Send

---

"Search & Send" is a destination entry service. You can find further information on "Search & Send" in the separate COMAND operating instructions.

### Vehicle remote opening

---

If you have unintentionally locked your vehicle (e.g. the SmartKey is inside the vehicle) and a replacement key is not available:

- ▶ Contact the following service hotlines:
  - **USA:** Response Center under the number 866-990-9007
  - **Canada:** Customer Service under 1-888-923-8367

You will be asked for your password.
- ▶ Return to your vehicle at the time arranged with the Response Center.
- ▶ Pull the tailgate handle for at least 20 seconds until the indicator lamp in the SOS button (▷ page 271) flashes. The Connecting Call message appears in the multifunction display.

Alternatively, the vehicle can also be opened via the Internet in the "Owners Online" section using your ID number and password<sup>43</sup>.

- i** Vehicle remote unlocking is only possible if the corresponding cellular phone network is accessible.

The SOS button flashes and the Call Connected message appears in the multifunction display to confirm that the command for vehicle remote unlocking has been received.

If you pull the tailgate handle for more than 20 seconds before receiving authorization for remote unlocking from the Response Center, you must wait 15 minutes before you can pull on the handle of the tailgate again.

### Stolen Vehicle Recovery Services

---

If your vehicle has been stolen:

- ▶ Contact the police.
  - The police will issue an incident report. This report has a number.
- ▶ This number will be forwarded to the Response Center together with your PIN. The Response Center will then attempt to covertly contact the mbrace system. The Response Center contacts you and the local law enforcement authority if the vehicle is located. However, only the law enforcement authority is informed of the location of the vehicle.
- i** If the anti-theft alarm system remains activated for longer than thirty seconds, mbrace is automatically connected to the Customer Assistance Center.

<sup>43</sup> USA only.

## Garage door opener

### Important safety guidelines

Up to three different door and gate systems can be operated using the remote control integrated in the overhead control panel.

**i** Certain garage door openers are not compatible with the integrated remote control. If you experience difficulties with the programming of the integrated remote control, contact an authorized Mercedes-Benz Center or call the following telephone assistance service:

- **USA:** Mercedes-Benz Customer Assistance Center on 1-800-FOR-MERCEdes
- **Canada:** Customer Service on 1-800-387-0100

#### Warning

Before programming the integrated remote control to a garage door opener or gate operator, make sure people and objects are out of the way of the device to prevent potential harm or damage. When programming a garage door opener, the door moves up or down. When programming a gate operator, the gate opens or closes.

Do not use the integrated remote control with any garage door opener that lacks safety stop and reverse features as required by U.S. federal safety standards (this includes any garage door opener model manufactured before April 1, 1982). A garage door that cannot detect an object - signaling the door to stop and reverse - does not meet current U.S. federal safety standards.

When programming a garage door opener, park vehicle outside the garage.

Do not run the engine while programming the integrated remote control. Inhalation of exhaust gas is hazardous to your health. All exhaust gas contains carbon monoxide (CO), and inhaling it can cause unconsciousness and possible death. All exhaust gas contains

carbon monoxide (CO), and inhaling it can cause unconsciousness and possible death.

**i** USA only:

This device complies with part 15 of the FCC rules. Operation is subject to the following two conditions:

1. The device must not cause harmful interference.
2. The device must withstand any interference received, including interference that may cause undesired operation.

Unauthorized modification of this device could void the device's operating permit.

**i** Canada only:

This device complies with the RSS-210 requirements of Industry Canada. Operation is subject to the following two conditions:

1. The device must not cause harmful interference.
2. The device must accept any interference received, including interference that may cause undesired operation.

Unauthorized modification of this device could void the user's authority to legally operate the device.

## Programming the remote control

### Programming

#### Warning!

Only press the transmitter button on the integrated remote control if there are no persons or objects present within the sweep of the garage door. People could otherwise be injured by the movement of the door.

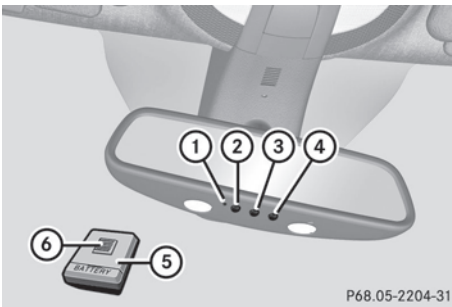

Remote control in the rear-view mirror

Garage door remote control ⑤ is not part of the garage door opener.

**i** To achieve the best result, insert new batteries in garage door remote control ⑤ of your garage door drive before programming.

- ▶ Erase the memory of the integrated remote control (▶ page 279) before programming it for the first time.
- ▶ Turn the SmartKey to position **2** in the ignition lock.
- ▶ Press and hold one of transmitter buttons ② to ④ on the integrated remote control.

After a short time, indicator lamp ① will start flashing. It flashes about once per second.

**i** Indicator lamp ① flashes immediately the first time that the transmitter button is programmed. If this transmitter button has already been programmed, indicator lamp ① will only start flashing at a rate of once per second after 20 seconds have elapsed.

- ▶ Keep the transmitter button depressed.
- ▶ Point transmitter button ⑥ of garage door remote control ⑤ towards the transmitter buttons on the rear-view mirror from a distance of 2 to 12 inches (5 to 20 cm).

**i** The distance between garage door remote control ⑤ and the integrated garage door opener depends on the system of the garage door drive. You might require

several attempts. You should test every position for at least 20 seconds before trying another position.

- ▶ Keep transmitter button ⑥ on garage door remote control ⑤ pressed until indicator lamp ① starts to flash rapidly. The programming has been successful if indicator lamp ① flashes rapidly.
- ▶ Release transmitter buttons ②, ③ or ④ on the integrated remote control or transmitter button on the garage door remote control ⑥.

If indicator lamp ① goes out after approximately 20 seconds and has not flashed rapidly:

- ▶ Release transmitter buttons ②, ③ or ④ on the integrated remote control or transmitter button on the garage door remote control ⑥.
- ▶ Repeat the procedure for the other transmitter buttons. When doing so, vary the distance between the garage door's remote control and the transmitter buttons in the rear-view mirror.

**i** If the garage door system works with a rolling code, you must synchronize the remote control integrated into the rear-view mirror with the garage door system receiver after programming.

You will find further information in the garage door opening system's operating instructions, e.g. the sections on "Synchronizing the transmitter" or "Registering a new transmitter". You can also call the hotline mentioned above.

**Notes on programming the remote control**

Canadian radio frequency laws require transmitter signals to "time-out" (or quit) after several seconds of transmission. This may not be long enough for the integrated signal transmitter to pick up the signal during programming. Similar to this Canadian law,

some U.S. gate operators are designed to "time-out" in the same manner.

If you live in Canada or have difficulties programming the garage door opener (regardless of where you live) when using the programming steps (see above), proceed as follows:

- ▶ Press transmitter button (②, ③ or ④) and hold it down during the following steps until the setup has been completed successfully.
- ▶ At the same time, press transmitter button ⑥ of the garage door remote control for two seconds, then release it for two seconds, then press it again for two seconds.
- ▶ Repeat this sequence on transmitter button ⑥ of the garage door remote control until the frequency signal has been learned.
- ▶ If the setup procedure is successful, indicator lamp ① flashes once slowly and goes out after a few seconds.
- ▶ Continue with the other programming steps (see above).

### Problems when programming

If you have problems when programming the integrated remote control, please note the following:

- check the transmitter frequency of garage door remote control ⑤ (which can usually be found on the rear of the remote control). The integrated remote control is compatible with equipment that operates in the frequency range 280 to 390 MHz.
- replace the batteries in garage door remote control ⑤. This increases the likelihood of garage door remote control ⑤ sending a strong and precise signal to the integrated remote control on the rear-view mirror.
- When aiming the garage door remote control at the transmitter buttons on the rear-view mirror, hold garage door remote control ⑤ at differing distances and angles

from the transmitter button that you are programming. Try different angles from a distance of 2 to 12 inches (5 to 30 cm) or the same angle from differing distances.

- If there is another garage door remote control for the same device, perform the programming steps again using the remote control. Before performing these steps, make sure that new batteries have been installed in the garage door remote control.
- Align the antenna cable of the garage door opener unit. This can improve signal reception/transmission.

### Opening or closing the garage door

Once programmed, the integrated remote control will assume the function of the garage door system's remote control. Please also read the operating instructions for the garage door system.



- ▶ Turn the SmartKey to position **2** in the ignition lock.
- ▶ Press transmitter button ②, ③ or ④ in the overhead control panel that you have programmed to operate the garage door.
  - Garage door system with fixed code: indicator lamp ① lights up continuously.
  - Garage door system with rolling code: indicator lamp ① flashes briefly and then lights up for approximately two seconds. This is repeated for up to 20 seconds.
- ① The transmitter will transmit a signal for as long as the transmitter button is being pressed. The transmission will be halted after a maximum of 20 seconds and indicator lamp ① will flash. Press the transmitter button again, if necessary.

### Clearing the remote control memory

- ▶ Turn the SmartKey to position **2** in the ignition lock.
- ▶ Press and hold transmitter buttons **②** and **④** for approximately 20 seconds until indicator lamp **①** flashes rapidly. The memory is cleared.

**i** You should clear the remote control memory before selling the vehicle.

### Compass

- ▶ **To call up the compass:** press the  or  button on the multifunction steering wheel repeatedly until the AIRMATIC/Compass menu appears in the multifunction display. The compass indicates the direction in which the vehicle is currently driving: N, NE, E, SE, S, SW, W or NW.

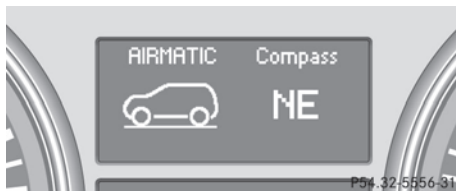

**i** If your vehicle is not equipped with the AIRMATIC package, the multifunction display only shows the compass.

### Floormat on the driver's side

#### **Warning!**

Whenever you are using a floormat, make sure there is enough clearance and that the floormat is securely fastened.

The floormat should always be securely fastened using the fastening equipment. Before driving off, check that the floormat is securely in place and adjust it if necessary. A loose floormat could slip and hinder proper functioning of the pedals.

Do not place several floormats on top of each other as this may impair pedal movement.

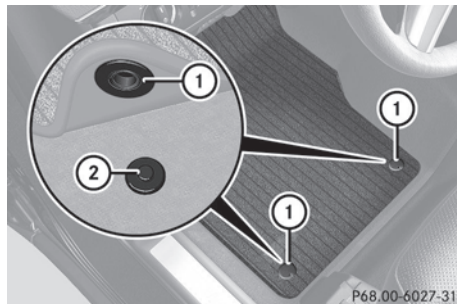

- ▶ Slide seat backwards.
- ▶ **To install:** place the floormat in position.
- ▶ Press floormat eyelets **①** onto retainer pins **②**.
- ▶ **To remove:** pull the floormats off their retainers **②**.
- ▶ Remove the floormat.

### Infrared-reflecting windshield

The infrared reflecting glass prevents the vehicle interior from becoming too hot. It also blocks radio waves up into the gigahertz range.

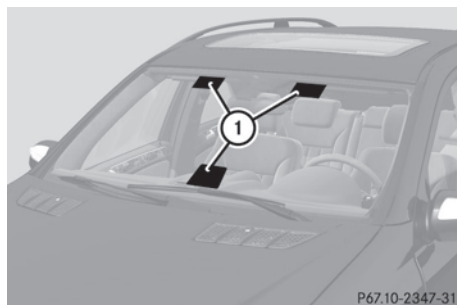

In order to operate radio-controlled equipment, e.g. toll systems, there are areas **①** on the windshield that are permeable to radio waves. In these areas, you can install radio-controlled systems. These areas can best be seen from outside the

vehicle by observing the light reflected off the windshield.

Vehicle equipment .....	282
Engine compartment .....	282
Maintenance .....	287
Care .....	288

## Vehicle equipment

**i** This manual describes all the standard and optional equipment of your vehicle which was available at the time of purchase. Country-specific differences are possible. Bear in mind that your vehicle may not feature all functions described here. This also refers to safety-related systems and functions.

## Engine compartment

### Hood

#### Opening the hood

##### **Warning**

Do not pull the release lever while the vehicle is in motion. Otherwise, the hood could be forced open by passing air flow.

This could cause the hood to come loose and injure you and/or others.

##### **Warning!**

HYBRID vehicles: It is imperative that you read the HYBRID Supplemental Operating Instructions included in your vehicle literature portfolio. You may otherwise not receive all necessary safety information and warning for the operation of your vehicle.

##### **Warning!**

Do not open the hood when the engine is overheated. You could be seriously injured. Observe the coolant temperature display to determine whether the engine may be overheated. If you see flames or smoke coming from the engine compartment, move away from the vehicle. Wait until the engine has cooled. If necessary, call the fire department.

##### **Warning!**

There is a risk of injury if the hood is open, even if the engine is not running.

Some engine components can become very hot.

To avoid the risk of burns, only touch those components described in the Operator's Manual and observe the relevant safety notes.

##### **Warning**

To help prevent personal injury, stay clear of moving parts when the hood is open and the engine is running.

The radiator fan may continue to run for approximately 30 seconds or may even restart after the engine has been turned off. Stay clear of fan blades.

##### **Warning!**

Vehicles with gasoline engine:  
The engine is equipped with a transistorized ignition system. Because of the high voltage it is dangerous to touch any components (ignition coils, spark plug sockets, diagnostic socket) of the ignition system

- with the engine running
- while starting the engine
- when the ignition is switched on and the engine is turned manually

##### **Warning!**

Vehicles with diesel engine:  
The engine is equipped with a high-voltage electronic control unit for the injection system. Because of the high voltage it is dangerous to touch any components of the injection system (injectors, electrical wires)

- with the engine running
- while starting the engine
- when the ignition is switched on

- ▶ Make sure that the windshield wipers are switched off.

##### **Warning!**

The windshield wipers and wiper linkage could be set in motion.

When the hood is open, you or others could be injured by the wiper linkage.

Make sure that the windshield wipers are switched off. Remove the SmartKey or make sure that no ignition position has been selected with KEYLESS-GO. All indicator lamps must be off in the instrument panel.

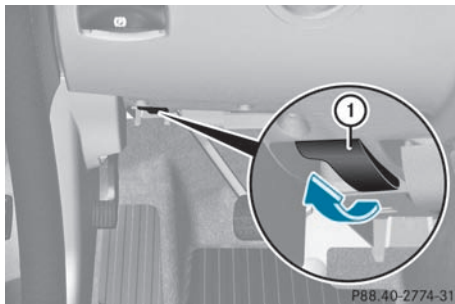

P88.40-2774-31

- ▶ Pull release lever ① on the hood. The hood is released.

**!** Make sure that the windshield wipers are not folded away from the windshield. You could otherwise damage the windshield wipers or the hood.

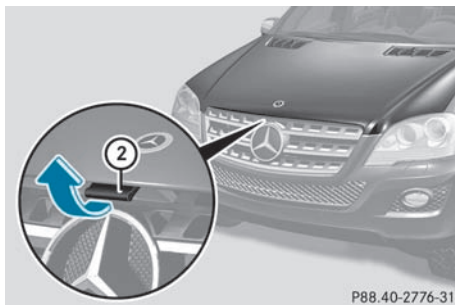

P88.40-2776-31

- ▶ Reach into the gap, pull hood catch handle ② up and lift the hood.

### Closing the hood

**⚠ Warning**

When closing the hood, use extreme caution not to catch hands or fingers. Be careful that you do not close the hood on anyone.

Make sure the hood is securely engaged before driving off. Do not continue driving if the hood can no longer engage after an accident, for example. The hood could otherwise come loose while the vehicle is in motion and injure you and/or others.

- ▶ Lower the hood and let it fall from a height of approximately 8 inches (20 cm).
- ▶ Check that the hood has engaged properly. If the hood can be raised slightly, it is not properly engaged. Open it again and close it with a little more force.

### Radiator

**i Vehicles with a diesel engine:** do not cover the radiator, for example with a winter front or bug cover. Otherwise, the readings of the on-board-diagnostic system may be inaccurate. Some of these readings are required by law and must be accurate at all times.

### Engine oil

#### Notes on the oil level

**⚠ Warning!**

HYBRID vehicles: It is imperative that you read the HYBRID Supplemental Operating Instructions included in your vehicle literature portfolio. You may otherwise not receive all necessary safety information and warning for the operation of your vehicle.

Depending on the driving style, the vehicle consumes up to 0.9 US qt (0.8 l) of oil over a distance of 600 miles (1000 km). The oil consumption may be higher than this when the vehicle is new or if you frequently drive at high engine speeds.

When checking the oil level:

- park the vehicle on a level surface.
- the engine should be switched off for at least five minutes if the engine is at normal operating temperature.
- the engine should be switched off for at least 30 minutes if it is not at normal operating temperature (i.e. if you only start the engine briefly).

### Checking the oil level using the oil dipstick

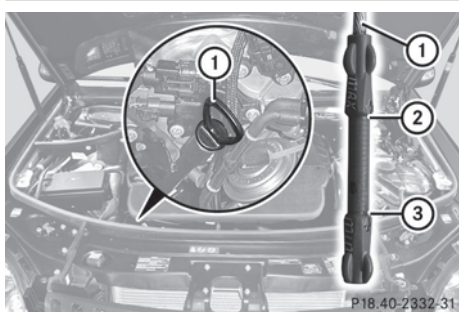

Example: vehicles with a gasoline engine

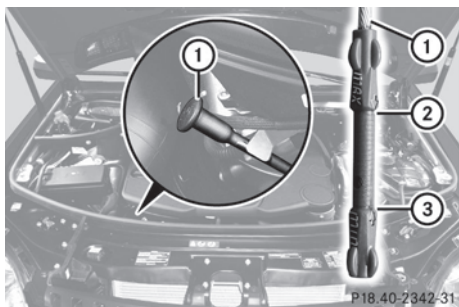

Example: vehicles with a diesel engine

- ▶ Pull oil dipstick ① out of the dipstick guide tube.
- ▶ Wipe off oil dipstick ①.
- ▶ Slowly insert oil dipstick ① into the dipstick guide tube to the stop, and take it out again.  
The oil level is correct if the level is between MIN mark ③ and MAX mark ②.
- ▶ Add oil if necessary.

### Adding engine oil

#### 🌱 Environmental note

When adding oil, take care not to spill any. If oil enters the soil or waterways, it is harmful to the environment.

⚠ Only use engine oils and oil filters which have been approved for vehicles with a service system. A list of the engine oils and oil filters that have been tested and approved according to the Mercedes-Benz specifications for service products can be found on the Internet at <http://www.mbusa.com> (USA only). Further information on tested and approved engine oils and oil filters can be obtained from any authorized Mercedes-Benz Center.

The following causes engine failure or damage to the exhaust system:

- using engine oils and oil filters that are not specifically approved for the service system
- replacing the engine oil and oil filter later than the specified replacement interval required by the service system
- using engine oil additives



Example: engine oil cap

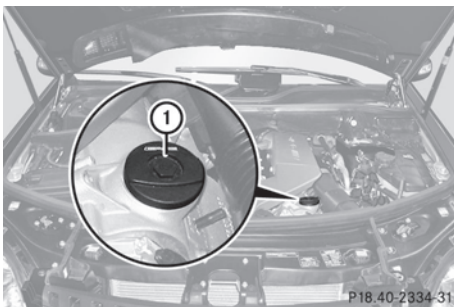

Engine oil cap (AMG vehicles)

- ▶ Turn cap ① counter-clockwise and remove it.
- ▶ Add the amount of oil required.

Fill carefully to the maximum mark on the oil dipstick.

**i** The difference in quantity between the MIN mark and the MAX mark on the dipstick is (depending on the engine) approximately 1.6 to 2.1 US qt. (1.5 to 2 l).

**!** Do not add too much oil. If the oil level is above the MAX mark on the dipstick, too much oil has been added. This can lead to damage to the engine or the catalytic converter. Have excess oil siphoned off.

Further information on engine oil (▷ page 361).

- ▶ Replace cap ① on the filler neck and tighten clockwise. Ensure that the cap locks into place securely.

### Checking and adding other service products

#### Checking the coolant level

Only check the coolant level when the vehicle is on a level surface and the engine has cooled down.

- ▶ Turn the SmartKey to position 2 (▷ page 139) in the ignition lock.

On vehicles with KEYLESS-GO, press the Start/Stop button twice (▷ page 139).

- ▶ Check the coolant temperature gauge in the multifunction display. The coolant temperature must be below 158 °F (70 °C).

#### **⚠ Warning**

In order to avoid any potentially serious burns:

- use extreme caution when opening the hood if there are any signs of steam or coolant leaking from the cooling system, or if the coolant temperature display indicates that the coolant is overheated.
- do not remove the pressure cap on the coolant reservoir if the coolant temperature is above 158 °F (70 °C). Allow the engine to cool down before removing the cap. The coolant reservoir contains hot fluid and is under pressure.
- using a rag, slowly turn the cap approximately  $1/2$  turn to relieve excess pressure. If opened immediately, scalding hot fluid and steam will be blown out under pressure.
- do not spill antifreeze on hot engine parts. Antifreeze contains ethylene glycol which may burn if it comes into contact with hot engine parts.

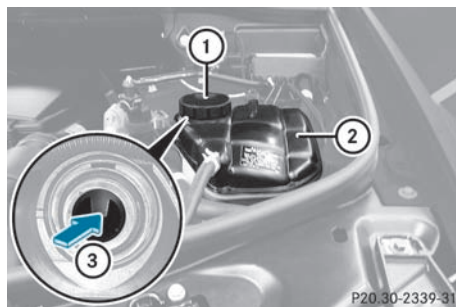

- ▶ Slowly turn cap ① half a turn counter-clockwise and allow excess pressure to escape.
- ▶ Turn cap ① further counter-clockwise and remove it.  
If the coolant is at the level of marker bar ③ in the filler neck when cold, there is enough coolant in coolant expansion tank ②.  
If the coolant is approximately 0.6 in (1.5 cm) higher when warm, there is enough coolant in coolant expansion tank ②.
- ▶ If necessary, add coolant which has been tested and approved by Mercedes-Benz.
- ▶ Replace cap ① and turn it clockwise as far as it will go.

For further information on coolant, see (▷ page 362).

### Windshield washer system/headlamp cleaning system

The washer fluid reservoir is used for both the windshield washer system and the headlamp cleaning system.

#### Warning

Washer solvent/antifreeze is highly flammable. Do not spill washer solvent/antifreeze on hot engine parts, because it may ignite and burn. You could be seriously burned.

- ❗ At temperatures below freezing, always fill the washer fluid container with a mix of windshield washer concentrate and antifreeze additive. There is otherwise a risk of damaging the windshield washer system/headlamp cleaning system.
- ❗ Only use washer fluid concentrate which is suitable for plastic lenses. Unsuitable washer fluid concentrate could damage the plastic lenses of the headlamps.
- ❗ Do not add distilled or de-ionized water to the washer fluid container. Otherwise, the

fluid level measuring gauge could be damaged.

- ❗ Add windshield washer concentrate, e.g. MB SummerFit, to the washer fluid all year round.

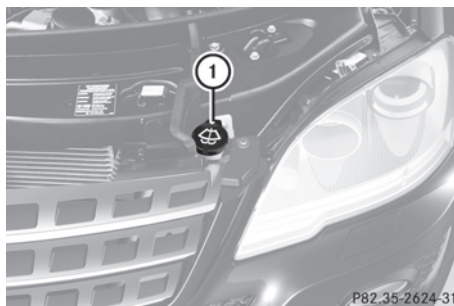

Example: washer fluid reservoir

- ▶ Mix the windshield washer fluid in a container beforehand.
- ▶ **At temperatures above freezing:** fill the washer fluid reservoir with a mix of water and windshield washer concentrate (e.g. MB SummerFit).
- ▶ **At temperatures below freezing:** fill the washer fluid reservoir with a mix of water and MB SummerFit windshield washer concentrate. For information on the mixing ratio, see (▷ page 363) or use the premixed windshield washer solution with antifreeze available in specialist stores.
- ▶ **To open:** pull cap ① upwards by the tab.
- ▶ Add the premixed washer fluid.
- ▶ **To close:** press cap ① onto the filler neck until it engages.

### Brake fluid level

- ❗ If you discover that the brake fluid level in the brake fluid reservoir has fallen to the MIN mark or below, check the brake system for leaks immediately. Also check the brake lining thickness. Contact a qualified specialist workshop, e.g. an authorized Mercedes-Benz Center immediately.

Do not top up the brake fluid. This will not rectify the malfunction.

Only check the brake fluid level when the vehicle is stationary and on a level surface.

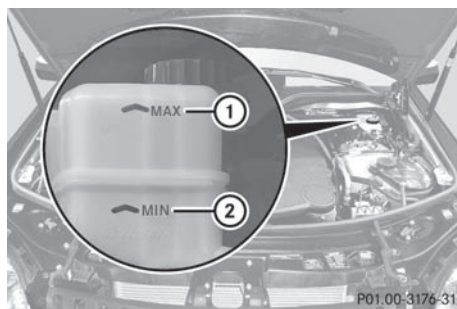

The brake fluid level is correct if it is between MIN marking ② and MAX marking ① on the brake fluid reservoir.

## Maintenance

### Service interval display

#### Service messages

Information on the type of service and service intervals (see separate Service Booklet).

You can obtain more information at an authorized Mercedes-Benz Center or at [www.mbusa.com](http://www.mbusa.com) (USA only).

The service interval display informs you of the next service due date.

If a service due date has been exceeded, you also hear an acoustic signal.

The multifunction display shows a service message for a few seconds, e.g.

Service A In .. Miles

Service A due now

Service A Exceeded By .. Miles

The letter indicates how much time the workshop will require to carry out the service work. The letters displayed range from A for a short service duration to H for a long service duration.

The service interval display does not take into account any periods of time during which the battery is disconnected.

Maintaining the time-dependent service schedule:

- ▶ Note down the service due date displayed in the multifunction display before disconnecting the battery.

or



- ▶ Subtract the battery disconnection periods from the service date shown on the display after reconnecting the battery.

#### Hiding the service message

- ▶ Press the  reset button on the instrument cluster (▷ page 28).

#### Displaying the service message

- ▶ Switch on the ignition.

- ▶ Press  or  to select the **standard display** menu on the steering wheel (▷ page 208).

- ▶ Select  or  to select the service interval display.

The service due date appears in the multifunction display.

#### Points to remember

A qualified specialist workshop, e.g. an authorized Mercedes-Benz Center, will reset the service interval display after the necessary service work has been carried out.

You can obtain more information, e.g. on maintenance work, at an authorized Mercedes-Benz Center or directly at Mercedes-Benz.

**!** If the service interval indicator has been inadvertently reset, this setting can be corrected at an authorized Mercedes-Benz Center.

Have the service work carried out as described in the Service Booklet. There may otherwise be increased wear, resulting

in damage to the vehicle or to the major assemblies.

## Care

### Notes on care

Regular care of your vehicle is a condition for retaining the quality in the long term.

Use care products and cleaning agents recommended and approved by Mercedes-Benz.

### Warning

Many cleaning products can be hazardous. Some are poisonous, others are flammable. Always follow the instructions on the particular container. Always open your vehicle's doors or windows when cleaning the inside.

Never use fluids or solvents that are not designed for cleaning your vehicle.

Always lock away cleaning products and keep them out of reach of children.

 For cleaning your vehicle, do not use any of the following:

- dry, rough or hard cloths
- abrasive cleaning agents
- solvents
- cleaning agents containing solvents

Do not scrub.

Do not touch the surfaces or protective films with hard objects, e.g. a ring or ice scraper. You could otherwise scratch or damage the surfaces and protective film.

### Environmental note

Dispose of empty packaging and cleaning cloths in an environmentally responsible manner.

 Do not park the vehicle for an extended period right after cleaning it, particularly after having cleaned the wheels with wheel cleaner. Wheel cleaners could cause increased corrosion of the brake discs and

brake pads/linings. Generally, park the vehicle at operating temperature after cleaning.

## Exterior care

### Automatic car wash

#### Warning!

Braking efficiency is reduced after washing the vehicle. This could cause an accident. For this reason, you must drive particularly carefully after washing the vehicle until the brakes have dried.

You can wash the vehicle in an automatic car wash from the very start.

 Never clean your vehicle in a Touchless Automatic Car Wash as these use special cleaning agents. These cleaning agents can damage the paintwork or plastic parts.

If the vehicle is very dirty, pre-wash it before cleaning it in an automatic car wash.

 In car washes with a towing mechanism, make sure that the automatic transmission is in transmission position **N**, otherwise the vehicle could be damaged.

- Vehicles with a SmartKey:

Do not remove the SmartKey from the ignition lock. Do not open the driver's door or front-passenger door when the engine is switched off. Otherwise, the automatic transmission selects park position **P** automatically and locks the wheels. You can prevent this by shifting the automatic transmission to **N** beforehand.

- Vehicles with KEYLESS-GO:

Do not open the driver's door or front-passenger door when the engine is switched off. Otherwise, the automatic transmission selects park position **P** automatically and locks the wheels.

Observe the following to make sure that the automatic transmission stays in position **N**:

- ▶ Make sure the vehicle is stationary and the ignition is switched off.
- ▶ Turn the SmartKey to position 2 (▷ page 139) in the ignition lock. Use the SmartKey instead of the Start/ Stop button on vehicles with KEYLESS-GO.
- ▶ Depress and hold the brake pedal.
- ▶ Shift the automatic transmission to position **N**.
- ▶ Release the brake pedal.
- ▶ Release the parking brake.
- ▶ Switch off the ignition and leave the SmartKey in the ignition lock.

**!** Make sure that the side windows are completely closed, that the ventilation/heating is switched off and that the windshield wiper switch is set to **0**. Otherwise, the rain/light sensor could be activated, triggering unintended wiper movements. This can cause damage to the vehicle.

After using an automatic car wash, wipe off wax from the windshield and the wiper blades. This will prevent smears and reduce wiping noises caused by residue on the windshield.

### Washing by hand

Carefully remove all deposits of road salt as soon as possible when driving in winter.

Also, clean the insides of the wheels when washing the underbody of the vehicle.

- ▶ Do not use hot water and do not wash the vehicle in direct sunlight.
- ▶ Use a soft car sponge for cleaning.
- ▶ Use a gentle cleaning agent, e.g. a Mercedes-Benz approved car shampoo.
- ▶ Wash down the vehicle with a gentle water jet.
- ▶ Do not point the water jet directly at the air inlets.
- ▶ Use plenty of water and rinse the sponge frequently.

- ▶ Rinse the vehicle with clean water and dry it thoroughly with a chamois.
- ▶ Do not allow the cleaning agent to dry on the paintwork.

### Power washers

#### Warning!

Do not use power washers with circular-jet nozzles (dirt grinders) to clean your vehicle, in particular the tires. You could otherwise damage the tires and cause an accident.

**!** Keep the distance between the vehicle and the nozzle of the power washer at 11.8 in (30 cm). Information about the correct distance is available from the equipment manufacturer.

Move the power washer nozzle around when cleaning your vehicle.

Do not aim directly at any of the following:

- tires
- door joint
- electrical components
- battery
- connectors
- lights
- seals
- trim elements
- ventilation slots

Damaged seals or electrical components can lead to leaks or failures.

### Cleaning the wheels

**!** Do not use acidic wheel cleaning products to remove brake dust. This could damage wheel bolts and brake components.

**!** Do not park the vehicle for an extended period right after cleaning it, particularly after having cleaned the wheels with wheel cleaner. Wheel cleaners could cause increased corrosion of the brake discs and brake pads/linings. For this reason, you should drive for a few minutes after

cleaning. Braking heats the brake discs and brake pads, thus drying them. The vehicle can then be parked up.

### Cleaning the paintwork

Scratches, corrosive deposits, areas affected by corrosion and damage caused by inadequate care cannot always be completely repaired. In such cases, visit a qualified specialist workshop immediately, e.g. an authorized Mercedes-Benz Center.

- ▶ Remove impurities immediately, where possible, whilst avoiding rubbing too hard.
- ▶ Soak insect remains with insect remover and rinse off the treated areas afterwards.
- ▶ Soak bird droppings with water and rinse off the treated areas afterwards.
- ▶ Remove coolant, brake fluid, tree resin, oils, fuels and greases by rubbing gently with a cloth soaked in petroleum ether or lighter fluid.
- ▶ Use tar remover to remove tar stains.
- ▶ Use silicone remover to remove wax.

**!** Do not affix:

- stickers
  - films
  - magnetic plates or similar items
- to painted surfaces. You could otherwise damage the paintwork.

If water no longer forms "beads" on the painted surface, paint care products should be used that have been approved and recommended by Mercedes-Benz. This is the case approximately every three to five months, depending on climatic conditions and the care product used.

If dirt has entered the paint surface or the paintwork has become dull, a paint cleaner should be used that has been approved and recommended by Mercedes-Benz.

Never use such care products in direct sunlight or on a hot hood.

- ▶ Use a suitable touch-up stick, e.g. MB Touch Up stick, for quick, temporary repair of damaged paintwork.

### Cleaning the windows

#### Warning!

Switch off the windshield wipers and remove the SmartKey from the ignition lock before cleaning the windshield or the wiper blades. On vehicles with KEYLESS-GO, press the Start/Stop button repeatedly until all indicator lamps in the instrument cluster have gone out. The windshield wipers could otherwise move and injure you.

- ▶ Clean the inside and outside of the windows with a damp cloth and a cleaning agent that is recommended and approved by Mercedes-Benz.
- !** Do not use dry cloths, abrasive products, solvents or cleaning agents containing solvents to clean the inside of the windows. Do not use hard objects to clean the insides of the windows, e.g. an ice scraper or ring. There is otherwise a risk of damaging the windows.
- !** Clean the water drainage channels of the windshield and the rear window at regular intervals. Under certain circumstances, deposits such as leaves, petals and pollen may prevent water from draining away, leading to corrosion damage.

### Cleaning the wiper blades

#### Warning!

Switch off the windshield wipers and remove the SmartKey from the ignition lock before cleaning the windshield or the wiper blades. On vehicles with KEYLESS-GO, press the Start/Stop button repeatedly until all indicator lamps in the instrument cluster have gone out. The windshield wipers could otherwise move and injure you.

- ❗ Do not pull the wiper blade. Otherwise, the wiper blade could be damaged.
- ❗ Do not clean wiper blades too often and do not rub them too hard. Otherwise, the graphite coating could be damaged. This could cause wiper noise.
- ▶ Fold the wiper arms away from the windshield.
- ▶ Carefully clean the wiper blades with a damp cloth.
- ▶ Fold the windshield wipers back again before switching on the ignition.
- ❗ Hold the wiper arm securely when folding back. The windshield could be damaged if the wiper arm smacks against it suddenly.

### Cleaning the headlamps

- ▶ Clean the plastic lamp lenses on the headlamps using a wet sponge and a mild cleaning agent, e.g. Mercedes-Benz car shampoo or cleaning cloths.
- ❗ Only use cleaning agents or cleaning cloths which are suitable for plastic headlamp lenses. Unsuitable cleaning agents or cleaning cloths could scratch or damage the plastic headlamp lenses.

### Cleaning the sensors

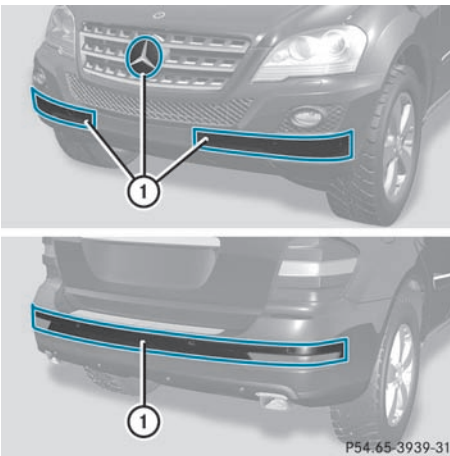

- ▶ Clean sensors ① of the driving systems with water, car shampoo and a soft cloth.

- ❗ When cleaning the sensors with a power washer, maintain a distance between the vehicle and the nozzle of the power washer of at least 11.8 in (30 cm). Information about the correct distance is available from the equipment manufacturer.

### Cleaning the rear view camera

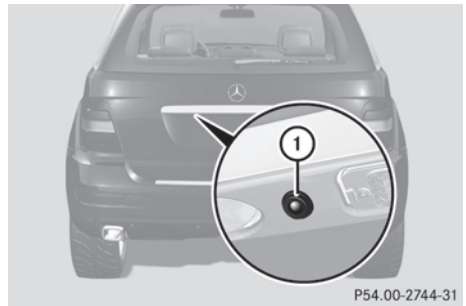

- ▶ Use clear water and a soft cloth to clean camera lens ①.
- ❗ Do not clean the camera lens and the area around the rear view camera with a power washer.

### Cleaning the exhaust tail pipes

Impurities combined with the effects of road grit and corrosive environmental factors may cause flash rust to form on the surface. You can restore the original shine of the exhaust tail pipe by cleaning it regularly, especially in winter and after washing.

- ❗ Do not clean the exhaust tail pipes with alkaline-based cleaning agents, such as wheel cleaner.
- ▶ Clean the exhaust tail pipes with a chrome care product tested and approved by Mercedes-Benz.

## Interior care

### Cleaning the display

- ▶ Before cleaning the display, make sure that it is switched off and has cooled down.
- ▶ Clean the display surface using a commercially-available microfiber cloth and TFT/LCD display cleaner.
- ▶ Dry the display surface using a dry microfiber cloth.

**!** For cleaning, do not use any of the following:

- alcohol-based thinner or gasoline
- abrasive cleaning agents
- commercially-available household cleaning agents

These may damage the display surface. Do not put pressure on the display surface when cleaning. This could lead to irreparable damage to the display.

### Cleaning the plastic trim

#### **Warning!**

When cleaning the steering wheel boss and dashboard, do not use cockpit sprays or cleaning agents containing solvents. Cleaning agents containing solvents cause the surface to become porous, and as a result, plastic parts may break away and be thrown around the interior when an air bag is deployed, which may result in severe injuries.

**!** Do not affix the following to plastic surfaces:

- stickers
  - films
  - scented oil bottles or similar items
- You can otherwise damage the plastic.

**!** Do not allow cosmetics, insect repellent or sunscreen to come into contact with the plastic trim. This maintains the high-quality look of the surfaces.

▶ Wipe the plastic trim with a damp, lint-free cloth, e.g. a microfiber cloth.

▶ **Heavy soiling:** use car care and cleaning products recommended and approved by Mercedes-Benz.

The surface may change color temporarily. Wait until the surface is dry again.

### Cleaning the steering wheel and gear or selector lever

▶ Wash thoroughly with a damp cloth or use a leather care agent that has been recommended and approved by Mercedes-Benz.

### Cleaning real wood and trim strips

▶ Wipe the wooden trim and trim strips with a damp, lint-free cloth, e.g. a microfiber cloth.

▶ **Heavy soiling:** use car care and cleaning products recommended and approved by Mercedes-Benz.

**!** Do not use solvent-based cleaning agents such as tar remover, wheel cleaners, polishes or waxes. There is otherwise a risk of damaging the surface.

**!** Do not use chrome polish for trim strips. The trim strips have a chrome look but are mostly made of anodized aluminum and can lose their shine if chrome polish is used. Use a damp, lint-free cloth instead when cleaning the trim strips.

Chrome polish can be used to remove very heavy soiling from trim strips which you are sure are made of chrome. If you are unsure as to whether a trim strip is chrome-plated or not, consult an authorized Mercedes-Benz Center.

### Cleaning the seat covers

**!** Do not use microfiber cloths to clean genuine leather, artificial leather or Alcantara® covers. If used often, these can damage the cover.

**!** Observe the following when cleaning:

- clean genuine leather covers carefully with a damp cloth and then wipe the covers down with a dry cloth. Make sure that the leather does not become soaked. It may otherwise become rough and cracked. Only use leather care agents that have been tested and approved by Mercedes-Benz. You can obtain these from a qualified specialist workshop, e.g. an authorized Mercedes-Benz Center.
- clean artificial leather covers with a cloth moistened with a solution containing 1% detergent (e.g. dish washing liquid).
- clean cloth covers with a microfiber cloth moistened with a solution containing 1% detergent (e.g. dish washing liquid). Rub carefully and always wipe entire seat sections to avoid leaving visible lines. Leave the seat to dry afterwards. Cleaning results depend on the type of dirt and how long it has been there.
- clean Alcantara® covers with a damp cloth. Make sure you wipe entire seat sections to avoid leaving visible lines.

**i** Note that regular care is essential to ensure that the appearance and comfort of the covers is retained over time.

### Cleaning the seat belts

► Use clean, luke-warm water and soap solution.

**!** Do not clean the seat belts using chemical cleaning agents. Do not dry the seat belts by warming them above 176 °F (80 °C) or placing them in direct sunlight.

#### **Warning**

Do not bleach or dye seat belts as this may severely weaken them. In a crash, they may not be able to provide adequate protection.

### Cleaning the roof lining and carpets

► **Roof lining:** use soft brushes or dry shampoo if it is particularly dirty.

► **Carpets:** use carpet and textile cleaners that have been approved and recommended by Mercedes-Benz.



Vehicle equipment .....	296
After an accident .....	297
Where will I find...? .....	297
Flat tire .....	300
Battery .....	312
Jump-starting .....	315
Towing and tow-starting .....	317
Fuses .....	320

## Vehicle equipment

- i** This manual describes all the standard and optional equipment of your vehicle which was available at the time of purchase. Country-specific differences are possible. Bear in mind that your vehicle may not feature all functions described here. This also refers to safety-related systems and functions.

## After an accident

Problem	Possible causes/consequences and ► Solutions
Fuel is leaking from the vehicle.	<p><b>⚠ Risk of explosion or fire</b></p> <p>The fuel line or the fuel tank is faulty.</p> <ul style="list-style-type: none"> <li>► Immediately turn the key to position <b>0</b> (► page 139) in the ignition lock and remove it.</li> <li>► Do not restart the engine under any circumstances.</li> <li>► Consult a qualified specialist workshop.</li> </ul>
You are unable to determine the extent of the damage.	<ul style="list-style-type: none"> <li>► Consult a qualified specialist workshop.</li> </ul>
You cannot detect any damage.	<ul style="list-style-type: none"> <li>► Start the engine as normal.</li> </ul>
The NECK-PRO head restraints on the driver's and front-passenger seats have been triggered.	<p>Your vehicle has been involved in a rear-end collision.</p> <ul style="list-style-type: none"> <li>► Reset the triggered NECK-PRO head restraints (► page 53).</li> </ul>

## Where will I find...?

## First-aid kit

- Open the tailgate.

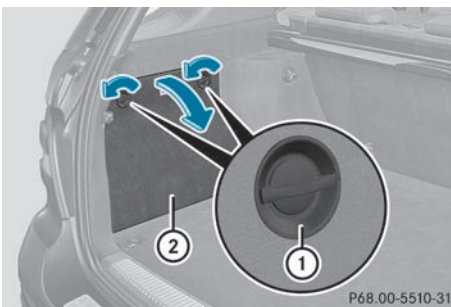

- **To open the side trim panel:** turn rotary knobs ① 90° in the direction of the arrow and open side trim panel ②.

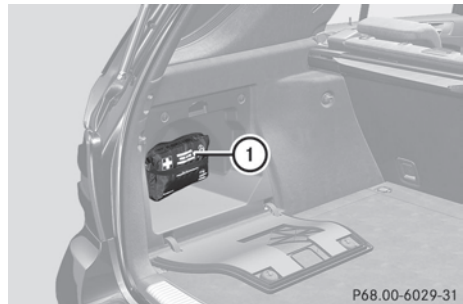

- **To remove the first-aid kit:** remove first-aid kit ①.
- i** Check the expiration date on the first-aid kit at least once a year. Replace the contents if necessary, and replace missing contents.

## Vehicle tool kit

### Notes

The vehicle tool kit can be found in the stowage well under the cargo compartment floor.

- i** Vehicles without a spare wheel are not equipped at the factory with the tools needed to change a wheel, e.g. a jack or lug wrench. Some tools for changing a wheel are specific to the vehicle. To obtain tools approved for your vehicle, visit a qualified specialist workshop, e.g. an authorized Mercedes-Benz Center.

### Folding the cargo compartment floor up

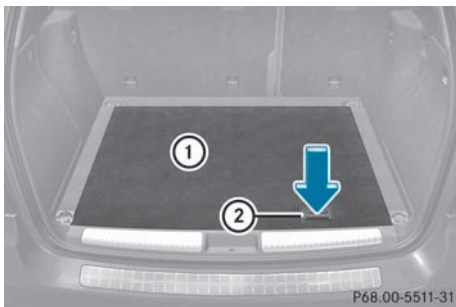

- ▶ Press release handle (2) in the direction of the arrow.
- ▶ Lift cargo compartment floor (1) up by release handle (2).

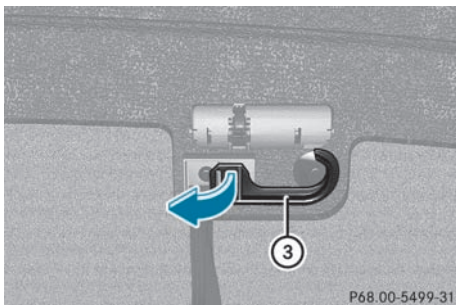

- ▶ Fold out hook (3) on the underside of the cargo compartment floor.

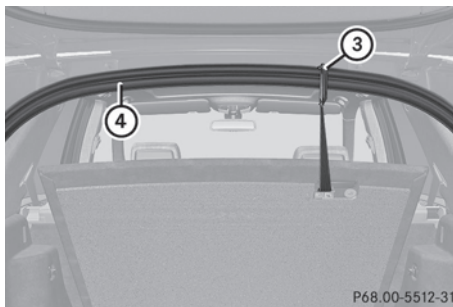

- ▶ Attach hook (3) to upper seal (4) in the cargo compartment.

### Vehicles with a TIREFIT kit

- ▶ Lift the cargo compartment floor up (▷ page 298).

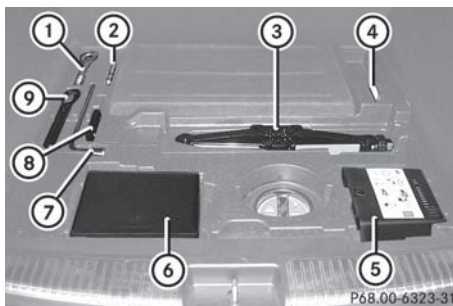

- ① Towing eye
- ② Alignment bolt
- ③ Jack
- ④ Fuse allocation chart
- ⑤ Electric air pump<sup>44</sup>
- ⑥ TIREFIT kit<sup>44</sup>
- ⑦ Lug wrench
- ⑧ Folding wheel chock
- ⑨ Ratchet ring spanner

### Vehicles with a "Minispare" emergency spare wheel/collapsible spare wheel

- ▶ Lift the cargo compartment floor up (▷ page 298).

<sup>44</sup> Vehicles with BlueTEC 4MATIC (vehicles for Canada) are only available from the factory with 20" wheels.

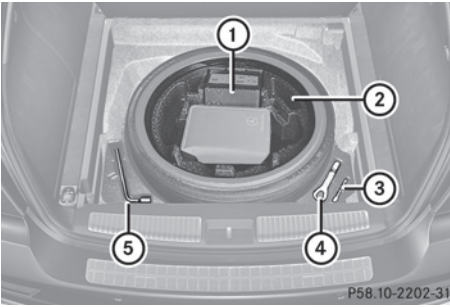

Example: vehicles with a collapsible spare wheel

- ① Electric air pump<sup>45</sup>
- ② Stowage well
- ③ Alignment bolt
- ④ Towing eye
- ⑤ Lug wrench

▶ Remove the "Minispare" emergency spare wheel or the collapsible spare wheel.

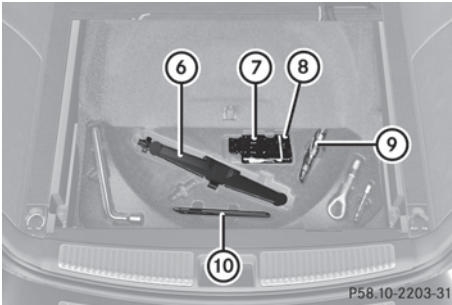

Example: vehicles with a collapsible spare wheel

- ⑥ Jack
- ⑦ Folding wheel chock
- ⑧ Fuse allocation chart
- ⑨ Wheel bolts<sup>46</sup>
- ⑩ Ratchet ring spanner

## "Minispare" emergency spare wheel/ collapsible emergency spare wheel

### Removing the "Minispare" emergency spare wheel/collapsible spare wheel

The emergency spare wheel is under the cargo compartment floor.

- ▶ Lift the cargo compartment floor up (▷ page 298).
- ▶ Depending on the vehicle's equipment, remove the stowage tray from the emergency spare wheel.

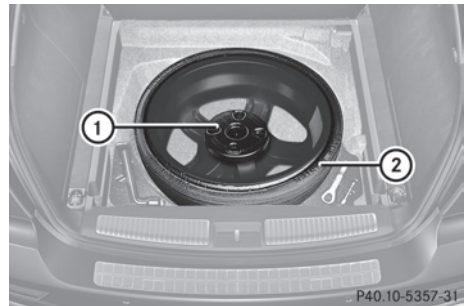

Example: collapsible spare wheel

- ▶ Turn emergency spare wheel retainer ① counter-clockwise and remove it.
- ▶ Remove the "Minispare" emergency spare wheel or collapsible spare wheel ②.

For further information on changing a wheel and mounting the spare wheel, see (▷ page 305).

### Stowing a used collapsible spare wheel

Take the following steps to stow a used collapsible spare wheel. It will otherwise not fit in the spare wheel well. Mercedes-Benz recommends that you have this work carried out at a qualified specialist workshop, e.g. an authorized Mercedes-Benz Center.

- ❗ Only place the collapsible spare wheel in the vehicle when it is dry. Otherwise, moisture may get into the vehicle.

<sup>45</sup> Only vehicles with a "Minispare" emergency spare wheel or a collapsible spare wheel.

<sup>46</sup> Only vehicles with a "Minispare" emergency spare wheel.

- ▶ Remove the valve extractor from the vehicle tool kit.
- ▶ Unscrew the valve cap from the valve.
- ▶ Unscrew the valve insert from the valve and release the air.
- i** Fully deflating the tire can take a few minutes.
- ▶ Screw the valve insert back into the valve.
- ▶ Screw the valve cap back on.
- ▶ Place the valve extractor back into the vehicle tool kit.
- ▶ Stow the collapsible spare wheel in the emergency spare wheel well under the cargo compartment and fasten in place.
- ▶ Make sure that highway level is selected<sup>48</sup>(▷ page 181).
- ▶ Stop the vehicle as far away as possible from traffic on solid, non-slippery and level ground.
- ▶ Switch on the hazard warning lamps.
- ▶ Firmly depress the parking brake.
- ▶ Bring the front wheels into the straight-ahead position.
- ▶ Move the DIRECT SELECT lever to **P**.
- ▶ Switch off the engine.
- ▶ **Vehicles without KEYLESS-GO:** remove the key from the ignition lock.
- ▶ **Vehicles with KEYLESS-GO:** open the driver's door.

## Flat tire

### Preparing the vehicle

Your vehicle may be equipped with:

- a TIREFIT kit<sup>47</sup>
- a "Minispare" emergency spare wheel
- a collapsible spare wheel
- the MOExtended run-flat system(▷ page 311)
- i** Vehicle preparation is not necessary on vehicles with the MOExtended run-flat system.
- i** Vehicles featuring the MOExtended run-flat system are not equipped with the TIREFIT kit at the factory. It is therefore recommended that you additionally equip your vehicle with the TIREFIT kit if you mount tires that do not feature run-flat properties, e.g. winter tires. You can obtain a TIREFIT kit from an authorized Mercedes-Benz Center, for example.

- ▶ The on-board electronics have status **0**, which is the same as the key having been removed.
  - ▶ **Vehicles with KEYLESS-GO:** remove the Start/Stop button from the ignition lock (▷ page 139).
  - ▶ All occupants must get out of the vehicle. Make sure that they are not endangered as they get out of the vehicle.
  - ▶ Make sure that no one is near the danger area whilst a wheel is being changed. Anyone who is not directly assisting in the wheel change should, for example, stand behind the barrier.
  - ▶ Get out of the vehicle. Pay attention to traffic conditions when doing so.
  - ▶ Close the driver's door.
  - i** Only operate the electric air pump using the socket in the footwell of the 2nd row of seats (▷ page 269), even if the ignition is turned off.
- An emergency cut-off ensures that the on-board voltage does not drop too low. If the on-board voltage is too low, power to the sockets is automatically cut-off. This

<sup>47</sup> Canada only.

<sup>48</sup> Vehicles with air suspension.

ensures that there is sufficient power to start the engine.

## TIREFIT kit

### Using the TIREFIT kit

You can use the TIREFIT kit to seal small punctures, particularly those in the tire tread. You can use TIREFIT at outside temperatures down to  $-4^{\circ}\text{F}$  ( $-20^{\circ}\text{C}$ ).

#### Warning

TIREFIT is a limited repair device. TIREFIT cannot be used for cuts or punctures larger than approximately 0.16 in (4 mm) and tire damage caused by driving with extremely low tire inflation pressure, or on a flat tire, or a damaged wheel.

Do not drive the vehicle under such circumstances.

Contact the nearest authorized Mercedes-Benz Center for assistance or call roadside assistance.

- ▶ Do not remove any foreign objects which have penetrated the tire, e.g. screws or nails.
- ▶ Remove the TIREFIT kit, the accompanying "max. 80 km/h" sticker and the electric air pump from the stowage well underneath the trunk floor (▶ page 298).

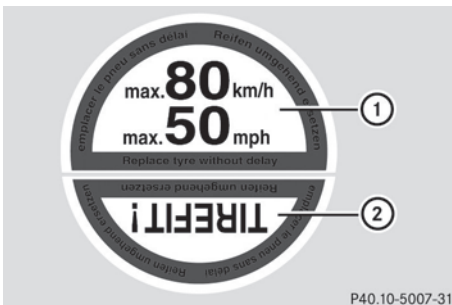

- ▶ Affix part ① of the sticker within the driver's field of vision.
- ▶ Affix part ② of the sticker near the valve on the wheel with the defective tire.

#### Warning!

Take care not to allow the contents of TIREFIT to come in contact with hair, eyes or clothing.

- If TIREFIT comes into contact with your eyes or skin, immediately rinse thoroughly with clean water.
- Change out of clothing which has come into contact with TIREFIT immediately.
- In case of allergic reaction or rash, consult a physician immediately.

Keep TIREFIT away from children.

- If TIREFIT is swallowed, immediately rinse your mouth out thoroughly with water and drink plenty of water.
- Do not induce vomiting. Consult a doctor immediately.
- Do not inhale TIREFIT fumes.

-  If TIREFIT leaks out, allow it to dry. It can then be removed like a layer of film. If you get TIREFIT on your clothing, have it cleaned as soon as possible with perchloroethylene.

#### Warning!

Comply with the manufacturer's safety instructions on the sticker on the electric air pump.

Your vehicle is provided with one of two different electric air pumps:

- **Version 1:** the hose with the pressure gauge and the cable are behind a flap.
- **Version 2:** the pressure gauge is in the electric air pump.

## TIREFIT kit version 1

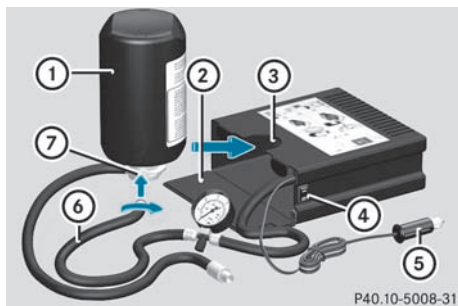

P40.10-5008-31

- ▶ Open flap (2).
- ▶ Pull connector (5) with the cable and hose (6) out of the housing.
- ▶ Screw hose (6) onto flange (7) of TIREFIT sealant filler bottle (1).
- ▶ Place TIREFIT sealant filler bottle (1) head downwards into recess (3) of the electric air pump.

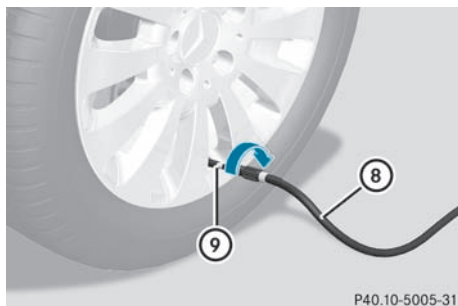

P40.10-5005-31

- ▶ Remove the cap from valve (9) on the faulty tire.

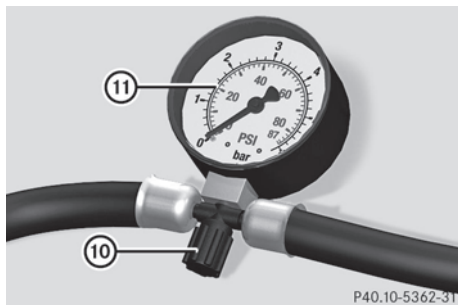

P40.10-5362-31

- ▶ Make sure pressure release screw (10) on pressure gauge (11) is fully closed.
- ▶ Screw filler hose (8) onto valve (9).
- ▶ Insert connector (5) into the socket in the footwell of the 2nd row of seats (▷ page 269).

**!** None of the other sockets or cigarette lighters are designed for operating the electric air pump.

- ▶ Turn the key to position 1 (▷ page 139) in the ignition lock.

- ▶ Press on/off switch (4) on the electric air pump to I.  
The electric air pump is switched on. The tire is inflated.

**i** First, TIREFIT is pumped into the tire. The pressure can briefly rise to approximately 500 kPa (5 bar/73 psi).

**Do not switch off the electric pump during this phase.**

- ▶ Let the electric pump run for five minutes. The tire should then have attained a pressure of at least 180 kPa (1.8 bar/26 psi).

**⚠ Warning**

The air hose can become hot during inflation. Please exercise appropriate caution.

- !** Do not operate the electric air pump for longer than eight minutes at a time without a break. It may otherwise overheat.

The air pump can be operated again once it has cooled down.

If after five minutes a pressure of 180 kPa (1.8 bar/26 psi) has been achieved, see (▷ page 304).

If after five minutes a pressure of 180 kPa (1.8 bar/26 psi) has not been achieved, see (▷ page 303).

## TIREFIT kit version 2

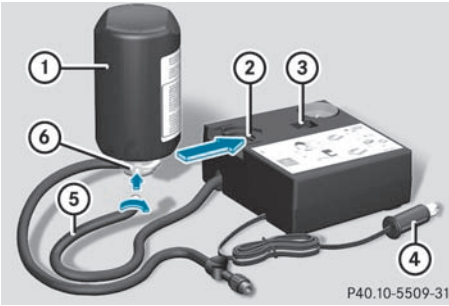

P40.10-5509-31

- ▶ Pull connector (4) with the cable and hose (5) out of the housing.
- ▶ Screw hose (5) onto flange (6) of TIREFIT sealant filler bottle (1).
- ▶ Place TIREFIT sealant filler bottle (1) head downwards into recess (2) of the electric air pump.

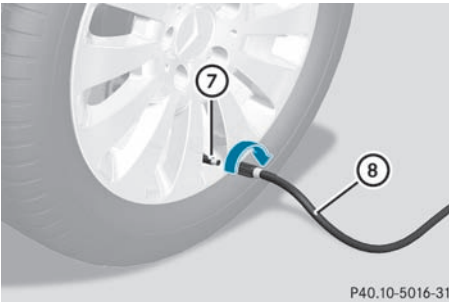

P40.10-5016-31

- ▶ Remove the cap from valve (7) on the faulty tire.
  - ▶ Screw filler hose (8) onto valve (7).
  - ▶ Insert connector (4) into the socket in the footwell of the 2nd row of seats (▷ page 269).
- !** None of the other sockets or cigarette lighters are designed for operating the electric air pump.

- ▶ Turn the key to position 1 (▷ page 139) in the ignition lock.
- ▶ Press on/off switch (3) on the electric air pump to I. The electric air pump is switched on. The tire is inflated.

**i** First, TIREFIT is pumped into the tire. The pressure can briefly rise to approximately 500 kPa (5 bar/73 psi).

**Do not switch off the electric pump during this phase.**

**⚠ Warning**

The air hose can become hot during inflation. Please exercise appropriate caution.

- !** Do not operate the electric air pump for longer than eight minutes at a time without a break. It may otherwise overheat. The air pump can be operated again once it has cooled down.

If after five minutes a pressure of 180 kPa (1.8 bar/26 psi) has been achieved, see (▷ page 304).

If after five minutes a pressure of 180 kPa (1.8 bar/26 psi) has not been achieved, see (▷ page 303).

**Tire pressure of 180 kPa (1.8 bar/ 26 psi) is not achieved**

If after five minutes a pressure of 180 kPa (1.8 bar/26 psi) has not been achieved:

- ▶ Press the on/off switch on the electric air pump to 0. The electric air pump is switched off.
- ▶ Unscrew the filler hose from the valve.
- ▶ Very slowly drive forwards or reverse approximately 30 ft (10 m).
- ▶ Pump up the tire again.

**⚠ Warning**

If after five minutes a pressure of 180 kPa (1.8 bar/26 psi) cannot be achieved, the tire is too badly damaged to be repaired reliably using TIREFIT.

In this case TIREFIT cannot seal the tire properly.

Do not drive any further.

Contact the nearest authorized Mercedes-Benz Center for assistance or call roadside assistance.

### Tire pressure of 180 kPa (1.8 bar/ 26 psi) is achieved

- ▶ Press the on/off switch on the electric air pump to **0**.  
The electric air pump is switched off.
- ▶ Remove the TIREFIT kit from the wheel.

#### Warning

The air hose may still be hot. Exercise proper caution to avoid burning yourself when detaching the electric air pump.

- ❗ After use, excess TIREFIT may run out of the filler hose. This could cause stains.  
Therefore, place the filler hose in the plastic bag which contained the TIREFIT kit.
- ▶ Stow the TIREFIT kit and the electric air pump.
- ▶ **Pull away immediately.**

#### Warning

Do not exceed a vehicle speed of 50 mph (80 km/h). A TIREFIT repair is not designed to operate at higher speeds.

The sticker must be attached on the instrument cluster where it will be easily seen by the driver.

Vehicle handling characteristics of a TIREFIT repaired tire may change. Adapt your driving accordingly.

- ▶ Stop after driving for approximately ten minutes and check the tire pressure with the electric air pump.

#### Warning

If tire inflation pressure has fallen below 130 kPa (1.3 bar/26 psi) do not continue to drive the vehicle.

Park your vehicle safely away from the roadway and contact the nearest authorized Mercedes-Benz Center or roadside assistance.

Have the damaged tire replaced.

- ▶ Correct the tire inflation pressure if it is at least 130 kPa (1.3 bar/26 psi) (for values see Tire and Load Information placard on the driver's side B-pillar or tire inflation pressure table inside the fuel filler flap).
- ▶ **To increase the tire pressure:** switch on the electric air pump.

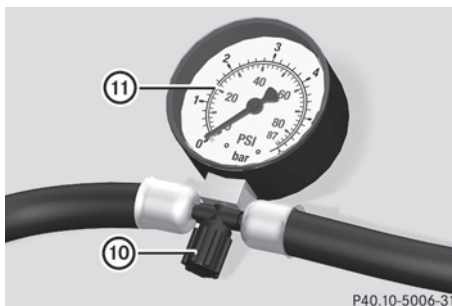

TIREFIT kit version 1

- ▶ **To reduce the tire pressure (version 1):** open pressure release screw **10** on pressure gauge **11**.

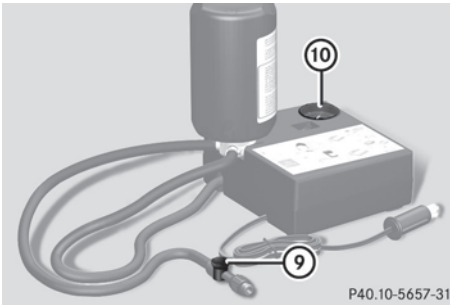

TIREFIT kit version 2

- ⑨ Pressure release button
- ⑩ Pressure gauge

- ▶ **To reduce the tire pressure (version 2):** press pressure release button ⑨ on the filler hose.
- ▶ Stow the TIREFIT kit and the electric air pump.
- ▶ Drive to the nearest workshop and have the tire changed there.
- ▶ Have the TIREFIT kit replaced as soon as possible at a qualified specialist workshop, e.g. at an authorized Mercedes-Benz Center.

#### Environmental note

Have the used TIREFIT kit disposed of professionally, e.g. at an authorized Mercedes-Benz Center.

- ▶ Have the TIREFIT kit replaced every four years at a qualified specialist workshop, e.g. an authorized Mercedes-Benz Center.

## Changing a wheel and mounting the spare wheel

### Preparing the vehicle

#### Warning!

The wheel and tire size of the emergency spare wheel/spare wheel may differ to that of the damaged wheel. When using an

emergency spare wheel/spare wheel the handling characteristics of the vehicle may change.

Adapt your style of driving accordingly.

Never operate the vehicle with more than one emergency spare wheel/spare wheel that differs in size.

Only use an emergency spare wheel/spare wheel of a differing size briefly and do not switch off ESP®.

When using an emergency spare wheel, you must not exceed a maximum speed of 50 mph (80 km/h).

#### Warning!

Have the emergency spare wheel/spare wheel replaced with a new wheel as soon as possible at a qualified specialist workshop which has the necessary specialist knowledge and tools to carry out the work required. Mercedes-Benz recommends that you use an authorized Mercedes-Benz Center for this purpose. In particular, work relevant to safety or on safety-related systems must be carried out at a qualified specialist workshop.

- ❗ Vehicles without an emergency spare wheel/spare wheel are not equipped with wheel-changing tools at the factory. For more information on which tools are required to perform a wheel change on your vehicle, e.g. wheel chock, alignment bolt or lug wrench, consult an authorized Mercedes-Benz Center.
- ▶ Prepare the vehicle as described (▷ page 300).
- ▶ If a trailer is coupled to the vehicle, uncouple it.
- ▶ Remove the following items from the stowage well under the trunk floor:
  - the emergency spare wheel<sup>49</sup>
  - the lug wrench
  - the folding wheel chock
  - the jack

<sup>49</sup> Vehicles with an emergency spare wheel.

- the ratchet ring spanner
- the alignment bolt
- the wheel bolts for the emergency spare wheel<sup>50</sup>
- the electric air pump<sup>51</sup>

- ▶ Secure the vehicle to prevent it from rolling away.

### Securing the vehicle to prevent it from rolling away

#### Warning

Only jack up the vehicle on level ground or on slight inclines/declines. The vehicle could otherwise fall off the jack and injure you or others.

If your vehicle is equipped with a wheel chock, it can be found in the vehicle tool kit (▶ page 298).

The folding wheel chock is an additional securing measure to prevent the vehicle from rolling away, for example when changing a wheel.

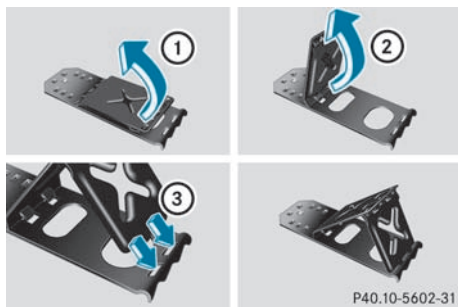

- ▶ Fold both plates upwards ①.
- ▶ Fold out lower plate ②.
- ▶ Guide the lugs on the lower plate fully into openings in base plate ③.

<sup>50</sup> Vehicles with "Minispare" emergency spare wheel.

<sup>51</sup> Vehicles with "collapsible spare wheel".

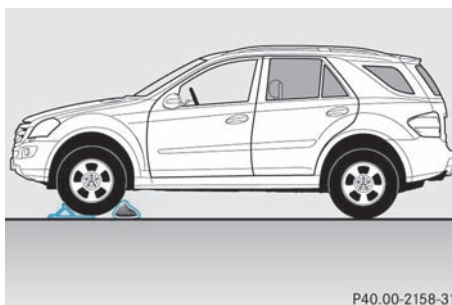

P40.00-2158-31

Securing the vehicle on level ground

- ▶ **On level ground:** place chocks or other suitable items under the front and rear of the wheel that is diagonally opposite the wheel you wish to change.

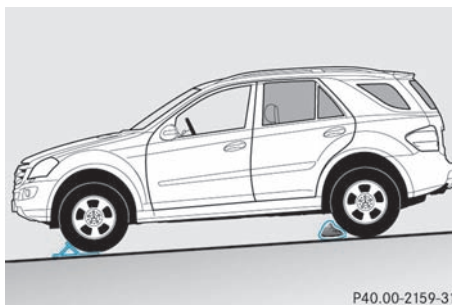

P40.00-2159-31

Securing the vehicle on slight downhill gradients

- ▶ **On downhill gradients:** place chocks or other suitable items in front of the wheels of the front and rear axle.

### Raising the vehicle

#### Warning

When jacking up the vehicle, only use the jack which has been specifically approved by Mercedes-Benz for your vehicle.

The jack is designed exclusively for jacking up the vehicle at the jacking points built into both sides of the vehicle. The jack saddle must be placed centrally under the jacking point. The jack must always be vertical when in use, especially on inclines or declines.

The jack is intended only for lifting the vehicle briefly for wheel changes. It is not suited for performing maintenance work under the vehicle. To help avoid personal injury, use the jack only to lift the vehicle during a wheel change.

Never get beneath the vehicle while it is supported by the jack. Keep hands and feet away from the area under the lifted vehicle. Always lower the vehicle onto sufficient capacity jackstands before working under the vehicle.

Always firmly engage the parking brake and block the wheels with wheel chocks or other sizable objects before raising the vehicle with the jack. Do not disengage the parking brake while the vehicle is raised.

Make sure that the ground on which the vehicle is standing and where you place the jack is solid, level and not slippery. If necessary, use a large underlay. On slippery surfaces, such as tiled floors, you should use a non-slip underlay, for example a rubber mat.

Do not use wooden blocks or similar objects as a jack underlay. Otherwise, the jack may not be able to achieve its load-bearing capacity if it is not at its full height.

Never start the engine when the vehicle is raised.

Also observe the notes on the jack.

The jacking points for the jack are located behind the wheel housings of the front wheels and in front of the wheel housings of the rear wheels (arrows).

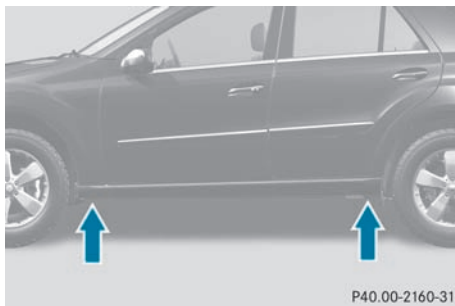

**Warning**

The jack is designed exclusively for jacking up the vehicle at the jacking points. The jack saddle must be placed centrally under the jacking point.

If you do not position the jack correctly in the jacking point, the vehicle can fall off the jack and seriously or fatally injure you or others.

❗ The jack is designed exclusively for jacking up the vehicle at the jacking points. Otherwise, your vehicle could be damaged.

► Take ratchet ring spanner out of the vehicle tool kit and place it on the hexagon nut of the jack so that the letters **AUF** are visible.



► Using lug wrench ①, loosen the bolts on the wheel you wish to change by about one full turn. Do not unscrew the bolts completely.

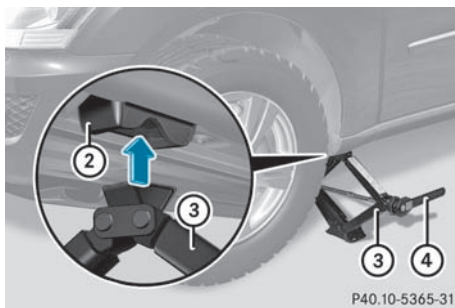

► Position jack ③ at jacking point ②.

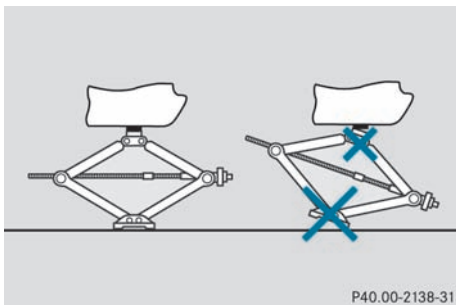

P40.00-2138-31

- ▶ Make sure that the base of the jack is positioned directly under the jacking point.
- ▶ Turn ratchet ring spanner ④ until jack ③ sits completely on jacking point ② and the base of the jack lies evenly on the ground.
- ▶ Turn ratchet ring spanner ④ until the tire is raised a maximum of 1.2 inches (3 cm) off the ground.

### Removing a wheel

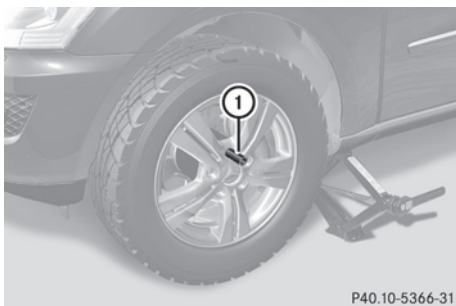

P40.10-5366-31

- ▶ Unscrew the uppermost wheel bolt completely.
  - ▶ Screw alignment bolt ① into the thread instead of the wheel bolt.
  - ▶ Unscrew the remaining wheel bolts fully.
- !** Do not place wheel bolts in sand or on a dirty surface. The bolt and wheel hub threads could otherwise be damaged when you screw them in.
- ▶ Remove the wheel.

### Mounting a new wheel

#### **⚠ Warning!**

Always replace wheel bolts that are damaged or rusted.

Never apply oil or grease to wheel bolts.

Damaged wheel hub threads should be repaired immediately. Do not continue to drive under these circumstances! Contact an authorized Mercedes-Benz Center or call Roadside Assistance.

Incorrect wheel bolts or improperly tightened wheel bolts can cause the wheel to come off. This could cause an accident. Make sure to use the correct wheel bolts.

#### **⚠ Warning!**

Only use genuine Mercedes-Benz wheel bolts. Other wheel bolts may come loose.

Do not tighten the wheel bolts when the vehicle is raised. Otherwise, the vehicle could fall off the jack.

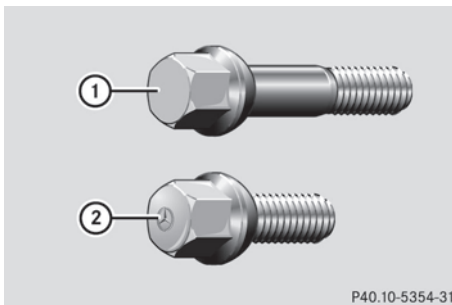

P40.10-5354-31

- ① Wheel bolts for 18", 19", 20" and 21" wheels or collapsible emergency spare wheel (AMG vehicles)
  - ② Wheel bolts for the "Minispare" emergency spare wheel
- !** Always use wheel bolts ② to mount the "Minispare" emergency spare wheel. Using other wheel bolts to mount the "Minispare" emergency spare wheel could damage the brake system.

**Warning**

Make sure to use the original length wheel bolts when remounting the original wheel after it has been repaired.

- ▶ Clean the wheel and wheel hub contact surfaces.

**!** To prevent damage to the paintwork, hold the wheel securely against the wheel hub while screwing in the first wheel bolt.



P40.10-5635-31

- ▶ Slide the emergency spare wheel onto the alignment bolt and push it on.
- ▶ Tighten the wheel bolts until they are finger-tight.
- ▶ Unscrew the alignment bolt.
- ▶ Tighten the last wheel bolt until it is finger-tight.
- ▶ **Vehicles with collapsible spare wheel:** inflate the collapsible spare wheel (▷ page 309) and then lower the vehicle (▷ page 310).

or

- ▶ **Vehicles with spare wheel/"Minispare" emergency spare wheel:** lower the vehicle (▷ page 310).

**Inflating the collapsible spare wheel**

**Warning!**

Pump up the collapsible spare wheel before lowering the vehicle. You could otherwise damage the wheel rim.

**Warning!**

Comply with the manufacturer's safety instructions on the sticker on the electric air pump.

Your vehicle is equipped with one of two electric air pumps:

- **Version 1:** electric air pump with pressure gauge on the air hose.
- **Version 2:** electric air pump with integrated pressure gauge.

The following description applies to both versions. Differences in the way they are used will be explained in detail.

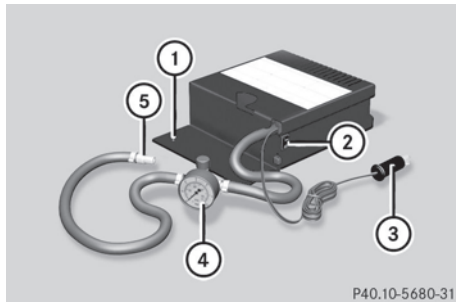

P40.10-5680-31

Version 1

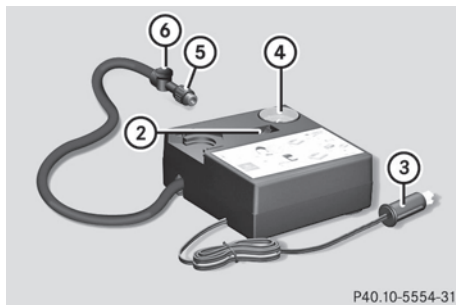

P40.10-5554-31

Version 2

- ▶ **Version 1:** open flap ①.
- ▶ **Version 1:** pull connector ③ and the air hose with pressure gauge ④ out of the housing.
- ▶ **Version 2:** pull connector ③ and the air hose out of the housing.

- ▶ **Version 1:** make sure that the pressure release screw on pressure gauge ④ is closed.
- ▶ Remove the cap from the valve on the collapsible spare wheel.
- ▶ Screw union nut ⑤ on the air hose onto the valve.
- ▶ Make sure on/off switch ② of the electric air pump is set to **0**.
- ▶ Insert connector ③ into the socket in the footwell of the 2nd row of seats (▷ page 269).

**!** None of the other sockets or cigarette lighters are designed for operating the electric air pump.

- ▶ Make sure that the SmartKey is in position 1 (▷ page 139) in the ignition lock.
- ▶ Press on/off switch ② on the electric air pump to **I**.  
The electric air pump is switched on. The tire is inflated.

#### **Warning**

The air hose and the union nut can become hot during inflation. Exercise proper caution to avoid burning yourself when using the equipment.

- !** Do not operate the electric air pump for longer than eight minutes at a time without a break. It may otherwise overheat.

The air pump can be operated again once it has cooled down.

- ▶ Pump the tire to the specified tire pressure. The specified tire pressure is printed on the yellow label of the emergency spare wheel.
- ▶ When the specified tire pressure has been reached, press on/off switch ② on the electric air pump to **0**.  
The electric air pump is switched off.
- ▶ Turn the SmartKey to position **0** in the ignition lock.
- ▶ **Version 1:** if the tire pressure is higher than the specified pressure, open the pressure

release screw on pressure gauge ④ until the correct tire pressure has been reached.

- ▶ **Version 2:** if the tire pressure is higher than the specified pressure, press pressure release button ⑥ until the correct tire pressure has been reached.
- ▶ Unscrew union nut ⑤ on the air hose from the valve.
- ▶ Screw the valve cap onto the collapsible spare wheel valve again.
- ▶ **Version 1:** stow plug ③ and the air hose behind flap ①.
- ▶ **Version 2:** stow plug ③ and the air hose in the lower section of the pump housing.
- ▶ Stow the electric air pump in the designated place in the vehicle.

## Lowering the vehicle

### **Warning!**

Vehicles with spare wheel with collapsible tire only: Inflate collapsible tire only after the wheel is properly attached.

Inflate the collapsible tire using the electric air pump **before** lowering the vehicle.

- ▶ Place the ratchet ring spanner onto the hexagon nut of the jack so that the letters **AB** are visible.
- ▶ Turn the ratchet ring spanner until the vehicle is once again standing firmly on the ground.
- ▶ Place the jack to one side.

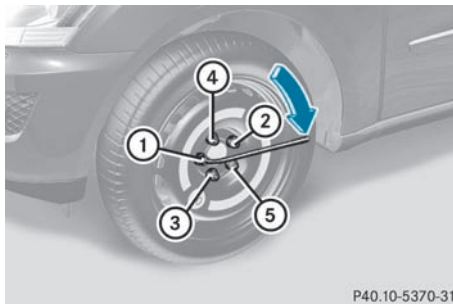

P40.10-5370-31

- ▶ Tighten the wheel bolts evenly in a crosswise pattern in the sequence indicated (① to ⑤). The tightening torque must be **110 lb-ft (150 Nm)**.

#### **Warning!**

Have the tightening torque checked immediately after a wheel is changed. The wheels could come loose if they are not tightened to a torque of **110 lb-ft (150 Nm)**.

- ▶ Turn the jack back to its initial position and store it together with the rest of the vehicle tool kit in the cargo compartment.

Vehicles with an emergency spare wheel:

- ▶ Wrap the faulty wheel in the protective film included with the emergency spare wheel and transport the wheel in the cargo compartment.

or

- ▶ Depending on the size of the wheel, you may also be able to secure the faulty wheel in the emergency spare wheel well. In this case, you must remove the stowage tray from the emergency spare wheel well and store it securely in the cargo compartment.

Further information on stowing the collapsible spare wheel (▷ page 299).

- i** When you are driving with the collapsible spare wheel mounted, the tire pressure loss warning system or the tire pressure monitor cannot function reliably. Only restart the tire pressure loss warning system/tire pressure monitor when the defective wheel has been replaced with a new wheel.

Vehicles with tire pressure monitor: all mounted wheels must be equipped with functioning sensors and the defective wheel should no longer be in the vehicle.

### **MOExtended run-flat system**

The MOExtended run-flat system allows you to drive on even if there is a complete loss of pressure in one or more tires.

The MOExtended run-flat system may only be used in conjunction with the activated tire pressure loss warning system or with the activated tire pressure monitor.

The maximum permissible distance which can be driven in run-flat mode depends on the cargo in the vehicle. You can drive 50 miles (80 km) if the vehicle is partially laden and 18 miles (30 km) if it is fully laden.

The maximum permissible distance which can be driven in run-flat mode is counted from the moment the tire pressure loss warning appears in the multifunction display.

You must not exceed a maximum speed of 50 mph(80 km/h).

#### **Warning!**

The handling characteristics of your vehicle deteriorate in run-flat mode, for example:

- when cornering
- when braking
- when accelerating rapidly

Adapt your driving style accordingly and avoid sudden changes in direction and sudden acceleration, as well as driving over obstacles (i.e. curbs, potholes), and driving off-road. This is particularly the case when the vehicle is heavily laden.

The maximum permissible distance that can be driven in run-flat mode depends to a large extent on the loads placed on the vehicle. It can be shorter due to high speeds, a heavy cargo, sudden changes in direction, the road surface condition, outside temperature, etc., or further if you drive carefully and conservatively.

Do not continue to drive in run-flat mode if:

- you hear banging noises.
- the vehicle starts to shake.
- you see smoke and smell rubber.

- ESP® is intervening constantly.
- there are tears in the sidewalls of the tire.

After driving in run-flat mode, you must have the wheel(s) checked for damage at a qualified specialist workshop which has the necessary specialist knowledge and tools to carry out the work required. The faulty tire must be replaced in every case.

Mercedes-Benz recommends that you use an authorized Mercedes-Benz Center for this purpose. In particular, work relevant to safety or on safety-related systems must be carried out at a qualified specialist workshop.

- i** When replacing one or all tires, make sure that you only use tires marked MOExtended and of the specified size for the vehicle.
- i** Vehicles featuring the MOExtended run-flat system are not equipped with TIREFIT kit at the factory. It is therefore recommended that you additionally equip your vehicle with the TIREFIT kit if you mount tires that do not feature run-flat properties, e.g. winter tires. You can obtain a TIREFIT kit from an authorized Mercedes-Benz Center, for example.

## Battery

### Important safety guidelines

In order for the battery to achieve the maximum possible service life, it must always be sufficiently charged.

- !** Have the battery checked regularly at a qualified specialist workshop, e.g. an authorized Mercedes-Benz Center. Observe the service intervals in the Service Booklet or for further information consult a qualified specialist workshop, e.g. an authorized Mercedes-Benz Center.

Have the battery charge checked more frequently if you use the vehicle mainly for

short trips or if you leave it standing idle for a lengthy period.

To prevent damage from corrosion, only replace the battery with one that has a central ventilation cover.

Only replace a battery with a battery that has been recommended by Mercedes-Benz.

Consult an authorized Mercedes-Benz Center if you wish to leave your vehicle parked for a long period of time.

#### Warning!

HYBRID vehicles: It is imperative that you read the HYBRID Supplemental Operating Instructions included in your vehicle literature portfolio. You may otherwise not receive all necessary safety information and warning for the operation of your vehicle.

#### Warning!

Comply with safety precautions and take protective measures when handling batteries.

Risk of explosion



Fire, naked flames and smoking are prohibited when handling the battery. Avoid creating sparks.



Battery acid is caustic. Avoid contact with the skin, eyes or clothing.



Wear suitable protective clothing, in particular gloves, an apron and a face mask.

Immediately rinse acid splashes off with clean water. Consult a doctor if necessary.

Wear eye protection.





Keep children away.



Observe this Operator's Manual.

**Environmental note**

Do not dispose of batteries in the household rubbish. Dispose of defective batteries in an environmentally responsible manner. Take them to an authorized Mercedes-Benz Center or to a special collection point for old batteries.

**Warning**

Failure to follow these instructions can result in severe injury or death.

Never lean over batteries while connecting. You might get injured.

Battery fluid contains sulfuric acid. Do not allow this fluid to come in contact with eyes, skin or clothing. In case it does, immediately flush affected area with water and seek medical help if necessary.

A battery will also produce hydrogen gas, which is flammable and explosive. Keep flames or sparks away from battery, avoid improper connection of jumper cables, smoking etc.

**Warning**

Do not place any metal objects on the battery as this could result in a short circuit.

Use leak-proof batteries only to avoid the risk of acid burns in the event of an accident.

Take care that you do not become statically charged, e.g. by wearing synthetic clothing or rubbing against textiles. For this reason, you also should not pull or push the battery over carpets or other synthetic materials.

Never touch the battery first. First, touch the outside body of the vehicle in order to release any possible electrostatic charges.

Do not rub the battery with rags or cloths. The battery could explode if touched due to electrostatic charge or due to spark formation.

**!** Switch off the engine and remove the SmartKey before disconnecting the terminal clamps from the battery. On vehicles with KEYLESS-GO, make sure that the ignition is switched off. Check that all the indicator lamps in the instrument cluster are off. You may otherwise destroy electronic components, such as the alternator.

**!** Like other batteries, the vehicle battery may discharge over time if you do not use the vehicle. In this case, have the battery disconnected at a qualified specialist workshop, e.g. an authorized Mercedes-Benz Center. You can also charge the battery with a charger recommended by Mercedes-Benz. Contact an authorized Mercedes-Benz Center for further information.

The battery, breather hose and cover of the positive terminal clamp must be installed securely during operation.

**i** Remove the SmartKey if you park the vehicle and do not require any electrical consumers. The vehicle will then use very little energy, thus conserving battery power.

Mercedes-Benz recommends that you do not carry out work on batteries yourself, e.g. removing, charging or replacing. Always have this work performed at a qualified specialist workshop, e.g. an authorized Mercedes-Benz Center.

**i** If the power supply has been interrupted, e.g. if the battery has been reconnected, you must carry out the following tasks:

- set the clock (> page 215)

On vehicles with COMAND and a navigation system, the clock is set automatically.

- reset the sliding sunroof (▷ page 89)
- reset the function for folding the exterior mirrors in/out automatically by folding the mirrors out once (▷ page 102)
- reset the side windows (▷ page 87)

### Charging the battery

#### Warning

Never charge a battery while still installed in the vehicle unless the accessory battery charge unit approved by Mercedes-Benz is being used. Gases may escape during charging and cause explosions that may result in paint damage, corrosion or personal injury.

An accessory battery charge unit specially adapted for Mercedes-Benz vehicles and tested and approved by Mercedes-Benz is available. It permits the charging of the battery in its installed position. Contact an authorized Mercedes-Benz Center for information and availability.

Charge the battery in accordance with the separate instructions for the accessory battery charger.

#### Warning!

There is a risk of acid burns during the charging process due to the gases which escape from the battery. Do not lean over the battery during the charging process.

#### Warning!

Battery acid is caustic. Avoid contact with the skin, eyes or clothing.

- ❗ Only charge the installed battery with a battery charger which has been tested and approved by Mercedes-Benz. These battery chargers allow the battery to be charged while still installed.

- ❗ Only use battery chargers with a maximum charging voltage of 14.8 V.

- ❗ Only charge the battery using the jump-starting connection point.

The jump-starting connection point is in the engine compartment (▷ page 315).

- ▶ Open the hood (▷ page 282).
- ▶ Connect the battery charger to the positive terminal and earth point in the same order as when connecting the donor battery in the jump-starting procedure (▷ page 315).

## Jump-starting

### Warning

Failure to follow these directions will cause damage to the electronic components, and can lead to a battery explosion and severe injury or death.

Never lean over batteries while connecting or jump starting. You might get injured.

Battery fluid contains sulfuric acid. Do not allow this fluid to come in contact with eyes, skin or clothing. In case it does, immediately flush affected area with water, and seek medical help if necessary.

A battery will also produce hydrogen gas, which is flammable and explosive. Keep flames or sparks away from battery, avoid improper connection of jumper cables, smoking, etc.

Attempting to jump start a frozen battery can result in it exploding, causing personal injury.

Read all instructions before proceeding.

### Warning!

HYBRID vehicles: It is imperative that you read the HYBRID Supplemental Operating Instructions included in your vehicle literature portfolio. You may otherwise not receive all necessary safety information and warning for the operation of your vehicle.

**!** Avoid repeated and lengthy starting attempts. Otherwise, non-combusted fuel may damage the catalytic converter<sup>52</sup> and create a risk of fire.

Do not use a rapid-charging device to start the engine.

Make sure the jumper cables are not damaged.

Make sure the jumper cables are not touching any other metal objects when they are connected to the battery.

If your vehicle's battery is discharged, the engine can be jump-started from another vehicle or from a second battery using jumper cables.

Observe the following points:

- ▶ The battery is not accessible in all vehicles. If the other vehicle's battery is not accessible, jump-start the vehicle using a second battery or a jump-starting device.
- ▶ Only jump-start the vehicle when the engine is cold and the catalytic converter system has cooled down<sup>53</sup>.
- ▶ Do not start the engine if the battery is frozen. Let the battery thaw first.
- ▶ Jump-starting may only be performed from batteries with a nominal voltage of 12 V. If you jump-start using a battery with higher voltage, it may damage the electrical systems of the vehicle.
- ▶ Only use jumper cables which have a sufficient cross-section and insulated terminal clamps.
- ▶ Make sure that the jumper cables cannot come into contact with parts, such as the pulley or the fan. These parts move when the engine is started and while it is running.
- ▶ If the battery is fully discharged, leave the battery that is being used to jump-start connected for a few minutes before attempting to start. This charges the battery a little.

<sup>52</sup> Only vehicles with a gasoline engine.

<sup>53</sup> Only vehicles with a gasoline engine.

**i** Jumper cables and further information about jump-starting can be obtained from any authorized Mercedes-Benz Center.

- ▶ Make sure that the two vehicles do not touch.
- ▶ Apply the parking brake firmly.
- ▶ Shift the transmission to position **P**.
- ▶ Switch off all electrical consumers (e.g. radio, blower etc.).
- ▶ Open the hood (▷ page 282).

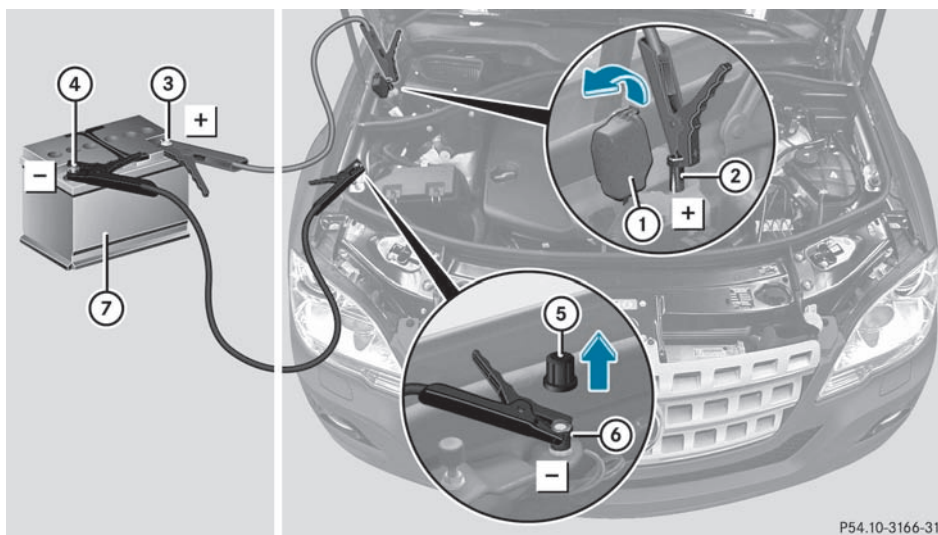

P54.10-3166-31

Position number ⑦ identifies the charged battery of the other vehicle or an equivalent jump-starting device.

**!** Never swap the terminal connections.

- ▶ Lift up cover ① of positive terminal ② in the direction of the arrow.
- ▶ Connect positive terminal ② on your vehicle to positive terminal ③ of donor battery ⑦ using the jumper cable, beginning with your own battery.
- ▶ Start the engine of the donor vehicle and run it at idling speed.
- ▶ Remove cover ⑤ from earth point ⑥.
- ▶ Connect negative terminal ④ of donor battery ⑦ to earth point ⑥ of your vehicle using the jumper cable, connecting the jumper cable to donor battery ⑦ first.
- ▶ Start the engine.

- ▶ First remove the jumper cable from earth point ⑥ and negative terminal ④, then from positive terminal ② and positive terminal ③, each time disconnecting from the battery on your own vehicle first.
- ▶ Have the battery checked at a qualified specialist workshop, e.g. an authorized Mercedes-Benz Center.

## Towing and tow-starting

### Important safety guidelines

#### Warning

Hybrid vehicles: ensure that you read the "HYBRID" supplement. You may otherwise fail to recognize dangers.

#### Warning

If you tow the vehicle, you must use a rigid towing bar if:

- the engine will not run.
- there is a malfunction in the brake system.
- there is a malfunction in the power supply or the vehicle's electrical system.

With the engine not running, there is no power assistance for the brake and steering systems. You will then need considerably more force to steer and to brake and the brake pedal travel will be longer. If necessary, depress the brake pedal with maximum force.

Before towing away, make sure that the steering can be moved and is not locked.

If you tow or tow-start another vehicle, its weight must not exceed the maximum permissible gross vehicle weight of your vehicle.

It is better to have the vehicle transported than to have it towed.

**!** You may only tow the vehicle a maximum distance of 30 miles (50 km). A towing speed of 30 mph (50 km/h) must not be exceeded.

For towing distances over 30 miles (50 km), the vehicle must be loaded onto a transporter.

**!** Only secure the tow rope or tow bar at the towing eyes. Otherwise, the vehicle could be damaged.

**!** Do not use the towing eye for recovery, as this could damage the vehicle. If in doubt, recover the vehicle with a crane.

**!** Drive slowly and smoothly when towing. Excessive tractive power could otherwise damage the vehicles.

**!** Do not tow with sling-type equipment. This could damage the vehicle.

**!** When towing vehicles with KEYLESS-GO, use the key instead of the Start/Stop button. Otherwise, the automatic transmission may shift to position **P** when the driver's or front-passenger door are opened, which could lead to damage to the transmission.

**!** Vehicles with differential locks: make sure that the differential locks are in automatic mode. When towing, the differential locks must not be switched on by hand. This could otherwise damage the transmission.

**!** Vehicles with automatic transmission must not be started by tow-starting. This could otherwise damage the transmission.

**!** Vehicles with 4MATIC must not be towed with the front or rear axle raised. This could otherwise damage the transmission.

If the vehicle has suffered transmission damage, have it carried away on a transporter or trailer.

The automatic transmission must be in position **N** when the vehicle is being towed.

Make sure that the battery is connected and charged. You will otherwise not be able to:

- turn the SmartKey to position **2** in the ignition lock.
- shift the automatic transmission to position **N**.

**i** Switch off the automatic locking feature before the vehicle is towed (▷ page 79). Otherwise, you could lock yourself out of the vehicle when pushing or towing the vehicle.

### Installing/removing the towing eye

#### Installing the towing eye

Vehicles with a trailer tow hitch: if possible secure the towing device on the trailer tow hitch (▷ page 198).

- ▶ Remove the towing eye from the vehicle tool kit (▷ page 298).

#### Warning

The exhaust tail pipe may be hot. You could burn yourself if you touch the tail pipe. Be particularly careful when removing the rear cover.

The mountings for the removable towing eyes are located in the bumpers. They are at the front and at the rear, under the covers.

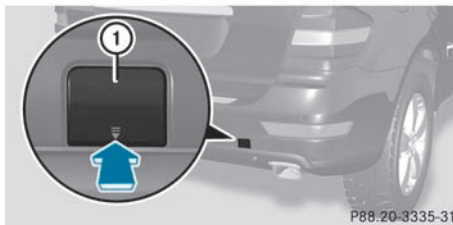

P88.20-3335-31

Vehicles with standard bumpers

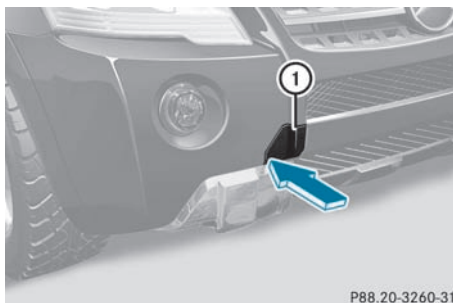

P88.20-3260-31

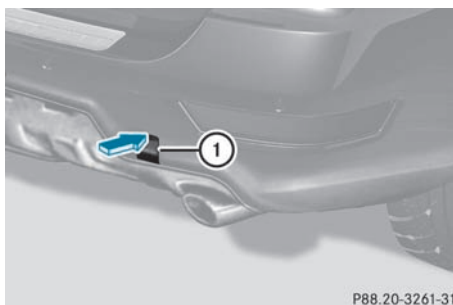

P88.20-3261-31

Vehicles with the AMG Sports package

- ▶ Press the mark on cover **1** inwards, in the direction of the arrow.
- ▶ Take cover **1** off the opening.
- ▶ Screw the towing eye in clockwise to the stop and tighten it.

## Removing the towing eye

- ▶ Loosen the towing eye and unscrew it.
- ▶ Attach cover ① to the bumper and press until it engages.
- ▶ Place the towing eye in the vehicle tool kit.

## Towing the vehicle with the rear axle raised

### Only possible for vehicles without 4MATIC.

When having your vehicle towed with the rear axle raised, observe the important safety notes (▷ page 317).

- ! The ignition must be switched off if you are towing the vehicle with the rear axle raised. Intervention by ESP® could otherwise damage the brake system.
- ▶ Switch on the hazard warning flashers (▷ page 109).
- ▶ Turn the SmartKey to position **0** in the ignition lock and remove the SmartKey.
- ▶ When leaving the vehicle, take the SmartKey or the KEYLESS-GO key with you.

## Towing vehicles with both axles on the ground

When having your vehicle towed, observe the important safety notes (▷ page 317).

### Warning

With the engine not running, there is no power assistance for the brake and steering systems. In this case, it is important to keep in mind that a considerably higher degree of effort is necessary to brake and steer the vehicle. Adapt your driving accordingly.

The automatic transmission automatically shifts to position **P** when you open the driver's or front-passenger door or when you remove the SmartKey from the ignition lock. In order to ensure that the automatic transmission stays in position **N** when towing, do the following:

- ▶ Make sure that the vehicle is stationary and that the SmartKey is in position **0** in the ignition lock.
- ▶ Turn the SmartKey to position **2** in the ignition lock.  
On vehicles with KEYLESS-GO, use the SmartKey instead of the Start/Stop button (▷ page 139).
- ▶ Depress and hold the brake pedal.
- ▶ Shift the automatic transmission to position **N**.
- ▶ Release the brake pedal.
- ▶ Release the parking brake.
- ▶ Switch on the hazard warning flashers (▷ page 109).
- ▶ Leave the SmartKey inserted in the ignition lock in position **2**.

- i When towing with the hazard warning flashers switched on, use the combination switch as usual to signal in which direction you are changing. In this case, only the indicator lamps for the direction of travel flash. When you reset the combination switch, the hazard warning flashers start flashing again.

## Transporting the vehicle

The towing eyes or trailer tow hitch can be used to pull the vehicle onto a trailer or transporter if you wish to transport it.

- ▶ Turn the SmartKey to position **2** in the ignition lock.
- ▶ Shift the automatic transmission to position **N**.

**As soon as the vehicle has been loaded:**

- ▶ Prevent the vehicle from rolling away by applying the parking brake.
  - ▶ Shift the automatic transmission to position **P**.
  - ▶ Turn the SmartKey to position **0** in the ignition lock and remove the SmartKey.
  - ▶ Secure the vehicle.
- !** Only lash the vehicle down by the wheels or wheel rims, not by parts of the vehicle such as axle or steering components. Otherwise, the vehicle could be damaged.

**Notes on 4MATIC vehicles**

- !** Vehicles with 4MATIC must not be towed with either the front or the rear axle raised, as doing so will damage the transmission.

If the vehicle's transmission, front, or rear axle is damaged, have the vehicle transported on a truck or trailer.

**In the event of damage to the electrical system**

If the battery is defective, the automatic transmission will be locked in position **P**. To shift the automatic transmission to position **N**, you must provide power to the vehicle's electrical system in the same way as when jump-starting (▷ page 315).

Have the vehicle transported on a transporter or trailer.

**Recovering a vehicle that has become stuck**

- !** Pull away smoothly, slowly, and in a straight line when pulling out a vehicle that has become stuck. Excessive tractive power could damage the vehicles.

If the drive wheels have become stuck in loose or muddy ground, pull the vehicle out with extreme caution, particularly if it is laden.

Never attempt to recover a stuck vehicle with a trailer attached.

Pull out the vehicle backwards, if possible using the tracks it made when it became stuck.

**Fuses****Important safety guidelines**

The fuses in your vehicle serve to close down faulty circuits. If a fuse blows, all the components on the circuit and their functions will fail.

**Warning**

Only use fuses approved by Mercedes-Benz with the specified amperage for the system in question and do not attempt to repair or bridge a blown fuse. Using other than approved fuses or using repaired or bridged fuses may cause an overload leading to a fire, and/or cause damage to electrical components and/or systems. Have the cause determined and remedied by an authorized Mercedes-Benz Center.

Blown fuses must be replaced with fuses of the same rating, which you can recognize by the color and value. The fuse ratings are listed in the fuse allocation chart. An authorized Mercedes-Benz Center will be happy to advise you.

- i** If a fuse has blown, visit a breakdown service or an authorized Mercedes-Benz Center.

If the newly inserted fuse also blows, have the cause traced and rectified at a qualified specialist workshop, e.g. an authorized Mercedes-Benz Center.

- !** Only use fuses that have been approved for Mercedes-Benz vehicles and which have the correct fuse rating for the system concerned. Otherwise, components or systems could be damaged.

**Before changing a fuse**

- ▶ Park the vehicle and apply the parking brake.
- ▶ Switch off all electrical consumers.
- ▶ Remove the key from the ignition lock.

The fuses are located in various fuse boxes:

- fuse box on the front-passenger side of the dashboard
- fuse box in the engine compartment on the right-hand side of the vehicle, when viewed in the direction of travel
- fuse box in the cargo compartment on the right-hand side of the vehicle, when viewed in the direction of travel

The fuse allocation chart is located in the vehicle tool kit (▷ page 298) in the stowage compartment under the trunk floor.

**Fuse box in the cockpit**

**!** Do not use a pointed object such as a screwdriver to open the cover in the dashboard. You could damage the dashboard or the cover.

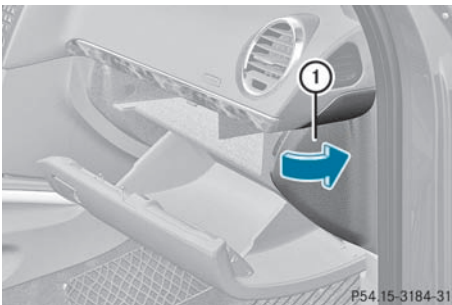

- ▶ **To open:** pull cover ① outwards in the direction of the arrow and remove it.
- ▶ **To close:** clip in cover ① on the front of the dashboard.
- ▶ Fold cover ① inwards until it engages.

**Fuse box in the engine compartment**

- ▶ Open the hood (▷ page 282).

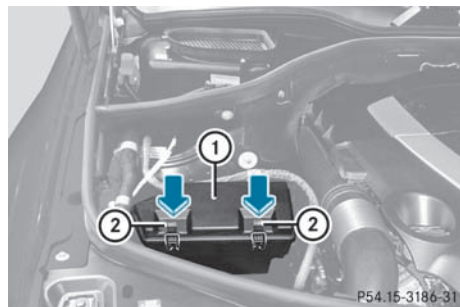

Example shows ML 350 (ML 350 BlueTEC, ML 550, AMG vehicles are similar)

- ▶ Remove any existing moisture from the fuse box using a dry cloth.
- ▶ **To open:** open clamps ②.
- ▶ Fold up cover ① and remove it towards the front of the vehicle.
- ▶ **To close:** check whether the rubber seal is lying correctly in cover ①.
- ▶ Insert cover ① at the rear of the fuse box into the retainer.
- ▶ Fold down cover ① and close clamps ②.

**!** The cover must be seated properly, otherwise moisture or dirt could impair the function of the fuses.

- ▶ Close the hood (▷ page 283).

**Fuse box in the cargo compartment**

- ▶ Open the tailgate.

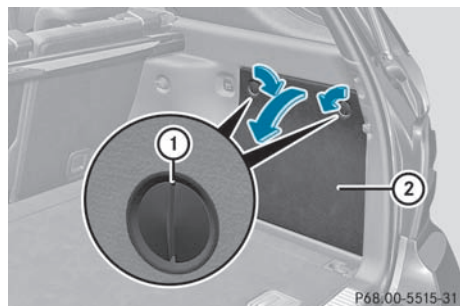

- ▶ **To open:** insert a suitable object, e.g. a coin, into the slot of release buttons ① on the cover.
- ▶ Turn release buttons ① 90° in the direction of the arrow.
- ▶ Open cover ② downwards.

### Engine emergency off

If the engine cannot be switched off as described, observe the following procedure:

- ▶ Take the fuse allocation chart out of the vehicle tool kit (▷ page 298).
- ▶ Open the fuse box in the engine compartment (▷ page 321).
- ▶ Remove fuse 120. The installation location of the fuse is described in the fuse allocation chart.

Vehicle equipment .....	324
Important safety guidelines .....	324
Directives to be observed .....	325
Maintenance and care of wheels and tires .....	325
Tire pressures .....	326
Maximum tire pressures .....	334
Loading the vehicle .....	334
Maximum tire load .....	338
Direction of rotation .....	338
Uniform Tire Quality Grading Standards .....	338
Interchanging the wheels .....	340
Tire labeling .....	340
Definitions for tires and loading .....	344
Wheel/tire combinations .....	347

## Vehicle equipment

**i** This manual describes all the standard and optional equipment of your vehicle which was available at the time of purchase. Country-specific differences are possible. Bear in mind that your vehicle may not feature all functions described here. This also refers to safety-related systems and functions.

## Important safety guidelines

Contact an authorized Mercedes-Benz Center if you require information on tested and recommended tires and wheels for summer and winter driving. Advice on purchasing and caring for tires is also available there.

### Warning

Replace rims or tires with the same designation, manufacturer and type as shown on the original part. For further information contact an authorized Mercedes-Benz Center. If incorrectly sized rims and tires are mounted, the wheel brakes or suspension components can be damaged. Also, the operating clearance of the wheels and the tires may no longer be correct.

### Warning

Worn, old tires can cause accidents. If the tire tread is worn to minimum tread depth, or if the tires have sustained damage, replace them.

When replacing rims, only use genuine Mercedes-Benz wheel bolts specified for the particular rim type. Failure to do so can result in the bolts loosening and possibly an accident.

Retreaded tires are not tested or recommended by Mercedes-Benz, since previous damage cannot always be recognized on retreads. The operating safety of the vehicle cannot be assured when such tires are used.

### Warning

If you feel a sudden significant vibration or ride disturbance, or you suspect that possible damage to your vehicle has occurred, you should turn on the hazard warning flashers, carefully slow down, and drive with caution to an area which is a safe distance from the road. Inspect the tires and the vehicle underbody for possible damage. If the vehicle appears unsafe, have the vehicle towed to the nearest authorized Mercedes-Benz Center or tire dealer for repairs.

### Warning

Do not drive with a flat tire. A flat tire affects the ability to steer or brake the vehicle. You might lose control of the vehicle. Continued driving with a flat tire or driving at high speed with a flat tire will cause excessive heat build-up and possibly a fire.

**i** For safety reasons, Mercedes-Benz recommends that you only use tires, wheels and accessories which have been approved by Mercedes-Benz specifically for your vehicle. These tires have been specially adapted for use with the control systems, such as ABS or ESP<sup>®</sup>, and are marked as follows:

- MO = Mercedes-Benz Original
- MOE = Mercedes-Benz Original Extended (tires with run-flat characteristics)
- MO1 = Mercedes-Benz Original (AMG)

Only use Mercedes-Benz Original Extended tires on wheels that have been specifically approved by Mercedes-Benz.

If you use other tires, wheels and accessories, Mercedes-Benz cannot accept any responsibility for damage that may result from this. Further information about tires, wheels and approved combinations can be obtained from any authorized Mercedes-Benz Center.

**i** Further information about tires and wheels can be obtained from any authorized Mercedes-Benz Center.

### Directives to be observed

- Only mount tires and wheels of the same type and make.
- Only mount tires of the correct size onto the wheels.
- After mounting new tires, run them in at moderate speeds for the first 60 miles (100 km) as they only reach their full performance after this distance.
- Do not use tires until they are excessively worn as the tire traction on wet road surfaces decreases significantly when the tread depth is less than  $\frac{1}{8}$  in (3 mm).
- If the vehicle is heavily laden, check the tire pressure and adjust it if necessary.
- When parking your vehicle, make sure that the tires do not get deformed by the curb or other obstacles. If it is necessary to drive over curbs, speed humps or similar elevations, try to do so slowly and at an obtuse angle. Otherwise, the tires, particularly the sidewalls, can get damaged.

### Maintenance and care of wheels and tires

#### Checking wheels and tires

##### Warning

Regularly check the tires for damage. Damaged tires can cause tire inflation pressure loss. As a result, you could lose control of your vehicle.

Worn, old tires can cause accidents. If the tire tread is worn to minimum tread depth, or if the tires have sustained damage, replace them.

- Regularly check the wheels and tires of your vehicle for damage (e.g. cuts, punctures, tears, bulges on tires and deformation or severe corrosion on wheels), at least once a month, as well as after driving off-road or on rough roads.

Damaged wheels can cause a loss of tire pressure.

- Regularly check the tire tread depth and the condition of the tread across the whole width of the tire (▷ page 325). If necessary, turn the front wheels to full lock in order to inspect the inner side of the tire surface.
- All wheels must have a valve cap to protect the valve against dirt and moisture. Do not install anything on the valve (such as tire pressure monitoring systems) other than the standard valve cap or other valve caps approved by Mercedes-Benz for your vehicle.
- Regularly check the pressure of all the tires including the emergency spare wheel or the spare wheel, particularly prior to long trips, and correct the pressure as necessary (▷ page 326).

#### Service life of tires

The service life of tires depends on the following factors amongst other things:

- driving style
- tire pressure
- mileage

Replace the tires after six years at the latest, regardless of wear. This also applies to the emergency spare wheel/spare wheel.

#### Tire tread

##### Warning

Although the applicable federal motor vehicle safety laws consider a tire to be worn when the tread wear indicators (TWI) become visible at approximately  $\frac{1}{16}$  in (1.6 mm), we recommend that you do not allow your tires to wear down to that level. As tread depth approaches  $\frac{1}{8}$  in (3 mm), the adhesion properties on a wet road are sharply reduced.

Depending upon the weather and/or road surface (conditions), the tire traction varies widely.

Do not use tires until they are excessively worn as the tire traction on wet road surfaces decreases significantly when the tread depth is less than  $\frac{1}{8}$  in (3 mm).

Tread wear indicators (TWI) are required by law. Six indicators are positioned over the tire tread. They are visible as soon as a tread depth of approximately  $\frac{1}{16}$  in (1.6 mm) is reached. If this is the case, the tire is so worn that it must be replaced.

The recommended tread depth for summer tires is at least  $\frac{1}{8}$  in (3 mm). The recommended tread depth for winter tires is at least  $\frac{1}{6}$  in (4 mm).

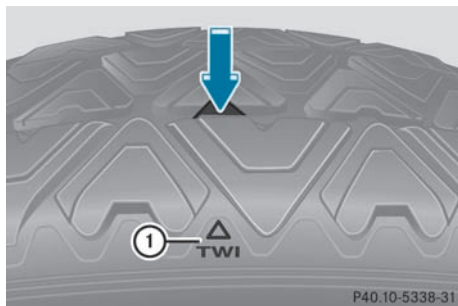

Bar marking ① for tread wear is integrated into the tire tread.

### Storing tires

Store tires that are not being used in a cool, dry and preferably dark place. Protect the tires from contact with oil, grease and fuel.

### Cleaning tires

**!** Do not use a high pressure jet with circular jet nozzles (concentrated-power jets) to clean the tires. The high pressure of the water jet could damage the tires. Always replace damaged tires.

## Tire pressures

### Tire pressure information

#### Warning

Follow recommended tire inflation pressures.

Do not underinflate tires. Underinflated tires wear excessively and/or unevenly, adversely affect handling and fuel economy, and are more likely to fail from being overheated.

Do not overinflate tires. Overinflated tires can adversely affect handling and ride comfort, wear unevenly, increase stopping distance, and result in sudden deflation (blowout) because they are more likely to become punctured or damaged by road debris, potholes etc.

Do not overload the tires by exceeding the specified load limit as indicated on the Tire and Loading Information placard on the driver's door B-pillar. Overloading the tires can overheat them, possibly causing a blowout. Overloading the tires can also result in handling or steering problems, or brake failure.

You will find a table of recommended tire pressures on the Tire and Loading Information placard on the B-pillar on the driver's side (> page 334). You will find a table of tire pressures for various operating conditions on the inside of your vehicle's fuel filler flap.

To test tire pressure, use a suitable pressure gauge. The outer appearance of a tire does not permit any reliable conclusion about the tire pressure. On vehicles installed with the electronic tire pressure monitor, the tire pressure can be checked in the on-board computer.

#### Warning!

Should the tire pressure drop repeatedly:

- check the tire for foreign bodies.
- check whether the wheel is losing air or the valve is leaking.
- make sure that only a valve cap approved by Mercedes-Benz is installed on the tire valve.

tire pressure that is too low have a negative effect on vehicle safety, which could lead you to cause an accident.

Only correct tire pressures when the tires are cold. The tires are cold when the vehicle has been parked for at least three hours or driven for less than 1 mile (1.6 km). The tire temperature changes depending on the outside temperature, the vehicle speed and the tire load. If the tire temperature changes by 18 °F (10 °C), the tire pressure changes by approximately 10 kPa (0.1 bar/ 1.5 psi). Take this into account when checking the pressure of warm tires and only correct the tire pressure if it is too low for the current operating conditions. If you check the tire pressure when the tires are warm, the resulting value will be higher than if the tires were cold. This is normal. Do not reduce the tire pressure to the value specified for cold tires. The tire pressure would otherwise be too low.

Observe the recommended tire pressure specifications for cold tires on the Tire and Loading Information placard on the B-pillar on the driver's side.

- i** The specifications given on the following Tire and Loading Information placard are examples. Tire pressure specifications are vehicle-specific and may deviate from the data shown here. The tire pressure specifications for your vehicle can be found on the Tire and Loading Information placard of your vehicle.

**TIRE AND LOADING INFORMATION**  
RENSEIGNEMENTS POUR LES PNEUS ET LE CHARGEMENT

SEATING CAPACITY / NOMBRE DE SIÈGES: 7  
FRONT / AVANT: 2  
MIDDLE / MILIEU: 3  
REAR / ARRIÈRE: 2

The combined weight of occupants and cargo should never exceed XXXX kg or XXXX lbs.  
Le poids total des occupants et des marchandises ne doit jamais dépasser XXXX kg ou XXXX lb.\*

TIRE / PNEU	SIZE / TAILLE	COLD TIRE PRESSURE / PRESSION DES PNEUS À FROID	SEE OWNERS MANUAL FOR ADDITIONAL INFORMATION
FRONT / AVANT	255/40 ZR18 99Y XL	200 KPA, 29 PSI	
REAR / ARRIÈRE	285/35 ZR18 101Y XL	200 KPA, 29 PSI	
SPARE / DE RECHANGE	175/55-18 95P	420 KPA, 40 PSI	

P40.00-2133-31

You will find recommended tire pressure specifications **1** for tires in a cold state and for a fully loaded vehicle on the Tire and Loading Information placard. The tire pressure specifications apply to tires which are installed at the factory.

### Important notes on tire pressures

#### Warning

If the tire pressure drops repeatedly, check the tires for punctures from foreign objects and/or whether air is leaking from the valves or from around the rim.

The tire temperature and pressure increase when the vehicle is in motion. This is dependent on the driving speed and the load. If you wish to drive at high speeds of 100 mph (160 km/h) or higher when this is allowed, use the tire pressure table on the inside of the fuel filler flap to set the correct tire pressures when the wheels are cold. If the tire pressure is not set correctly, this can lead to an excessive build up of heat and a sudden loss of pressure.

For more information, contact a qualified specialist workshop, e.g. an authorized Mercedes-Benz Center.

- i** Ride comfort may be affected if the tire pressure is adjusted to the recommended value for speeds of over 100 mph (160 km/h).

Make sure that the tire pressure for normal speeds is adopted again.

Additional specifications of tire pressure values for loads can also be found on the tire pressure table on the inside of the fuel filler flap.

The tire pressure for emergency spare wheels can be found:

- on the yellow sticker on the wheel rim of the emergency spare wheel
- in the "Tires" section (▷ page 347) in this Operator's Manual
- on the Tire and Loading Information placard on the driver's door B-pillar

**i** The specifications shown in the examples in the tire pressure tables are only examples. Tire pressure specifications are vehicle-specific and may deviate from the data shown here. The tire pressure specifications that are valid for your vehicle can be found on your vehicle's tire pressure table.

The tire pressures in the tire pressure table on the inside of the fuel filler flap are valid for all approved tires installed at the factory, unless stated otherwise.

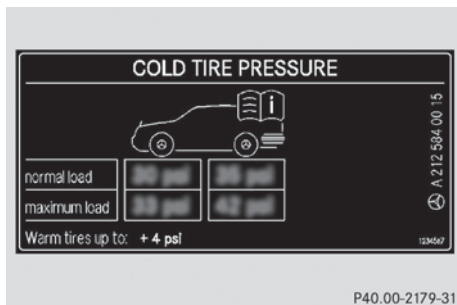

The tire pressure table is valid for all approved tires installed at the factory (example)

If the tire pressure precedes a tire size, the tire pressure specification is only valid for this tire size. The vehicle loading conditions "partially laden" or "fully laden" are specified using a differing number of persons and luggage in the table. The actual number of seats may differ from this.

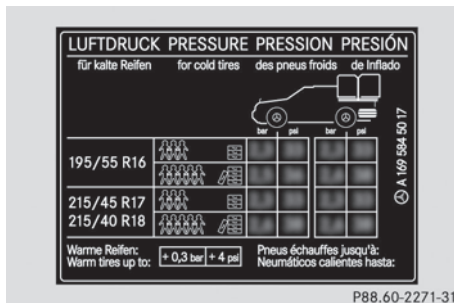

Tire pressure table with tire sizes (example)

Some tire pressure tables only show the rim diameter instead of the complete tire size, e.g. **R18**. The rim diameter is a component of the tire size and can be read from the tire sidewall (▷ page 341).

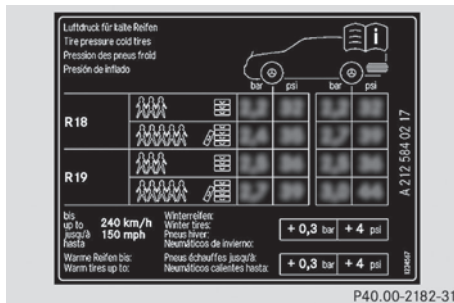

**i** For vehicles towing a trailer, the fully laden value on the tire inflation pressure label located on the inside of the fuel filler flap is valid for the rear axle.

## Tire pressure too low or too high

### Underinflated tires

#### **Warning**

Follow recommended tire inflation pressures. Do not underinflate tires. Underinflated tires wear excessively and/or unevenly, adversely affect handling and fuel economy, and are more likely to fail from being overheated.

Underinflated tires can:

- wear excessively and/or unevenly
- adversely affect fuel economy
- fail from being overheated
- adversely affect handling

**Overinflated tires can:**

### **Warning**

Follow recommended tire inflation pressures.

Do not overinflate tires. Overinflated tires can adversely affect handling and ride comfort, wear unevenly, increase stopping distance, and result in sudden deflation (blowout) because they are more likely to become punctured or damaged by road debris, potholes etc.

Overinflated tires can:

- adversely affect handling
- wear excessively and/or unevenly
- be more likely to become damaged
- adversely affect ride comfort
- increase stopping distance

## Checking the tire pressures

**Important safety guidelines**

### **Warning**

Follow recommended tire inflation pressures.

Do not underinflate tires. Underinflated tires wear excessively and/or unevenly, adversely affect handling and fuel economy, and are more likely to fail from being overheated.

Do not overinflate tires. Overinflated tires can adversely affect handling and ride comfort, wear unevenly, increase stopping distance, and result in sudden deflation (blowout) because they are more likely to become punctured or damaged by road debris, potholes etc.

Do not overload the tires by exceeding the specified load limit as indicated on the Tire

and Loading Information placard on the driver's door B-pillar. Overloading the tires can overheat them, possibly causing a blowout. Overloading the tires can also result in handling or steering problems, or brake failure.

Check the tire pressure at least once a month.

Only check and correct tire pressures when the tires are cold (▷ page 326).

## Checking the tire pressure manually

In order to determine and adjust the tire pressures, proceed as follows:

- ▶ Remove the valve cap of the tire you wish to check.
- ▶ Press the tire pressure gauge securely onto the valve.
- ▶ Read the tire pressure and compare it with the recommended value on the Tire and Loading Information placard on the B-pillar on the driver's side of your vehicle.
- ▶ If necessary, increase the tire pressure to the recommended value (▷ page 326).
- ▶ If the tire pressure is too high, release air by pressing down the metal pin in the valve using the tip of a pen, for example. Then, check the tire pressure again using the tire pressure gauge.
- ▶ Screw the valve cap onto the valve.
- ▶ Repeat the steps for the other tires.

## Tire pressure loss warning system (Canada only)

### Important safety guidelines

While the vehicle is in motion, the tire pressure loss warning system monitors the set tire pressure using the rotational speed of the wheels. This enables the system to detect significant pressure loss in a tire. If the speed of rotation of a wheel changes as a result of a loss of pressure, a corresponding warning

message will appear in the multifunction display.

### **Warning!**

When the multifunction display shows the message **Tire Pressure Check Tires**, one or more of your tires are significantly underinflated. You should stop and check your tires as soon as possible, and inflate them to the proper tire inflation pressure as indicated on the vehicle's Tire and Loading Information placard or on the tire inflation pressure label.

Driving on a significantly underinflated tire causes the tire to overheat and can lead to tire failure. Underinflation also reduces fuel efficiency and tire tread life, and may affect the vehicle's handling and stopping ability.

Each tire, including the spare, should be checked at least once a month when cold. Inflate the tires to the recommended tire inflation pressure as specified on

- the Tire and Loading Information placard on the driver's door B-pillar  
or
- the tire inflation pressure label located on the inside of the fuel filler flap

### **Warning!**

The tire pressure loss warning system does not provide a warning for wrongly selected tire inflation pressures. Always adjust tire inflation pressure according to the Tire and Loading Information placard on the driver's door B-pillar or on the tire inflation pressure label located on the inside of the fuel filler flap.

The tire pressure loss warning system does not replace regular checks of the tire inflation pressures since a gradual pressure loss in more than one tire cannot be detected by the tire pressure loss warning system.

The tire pressure loss warning system is not able to issue a warning due to a sudden dramatic loss of tire inflation pressure (e.g. tire blowout caused by a foreign object). In this case bring the vehicle to a halt by carefully

applying the brakes and avoiding abrupt steering maneuvers.

The function of the tire pressure loss warning system is limited or delayed if:

- snow chains are mounted on your vehicle's tires.
- road conditions are wintry.
- you are driving on sand or gravel.
- you adopt a very sporty driving style (cornering at high speeds or driving with high rates of acceleration).
- you are towing a very heavy or large trailer.
- you are driving with a heavy load or a load on the roof.

### **Restarting the tire pressure loss warning system**

Restart the tire pressure loss warning system if you have:





- changed the tire pressure
  - changed the wheels or tires
  - mounted new wheels or tires
- Before restarting, make sure that the tire pressures are set properly on all four tires for the respective operating conditions, using the Tire and Loading Information placard on the B-pillar on the driver's side or the tire pressure table on the fuel filler flap.
- Observe the notes in the section on tire pressures (▷ page 326).

### **Warning!**

The tire pressure loss warning system can only give reliable warnings if you have set the correct tire pressure.

If an incorrect tire pressure is set, these incorrect values will be monitored.

A tire with insufficient pressure results in vehicle instability when driving, thus increasing the risk of an accident.

- ▶ Make sure that the key is in position 2 (▷ page 139) in the ignition lock.
- ▶ Press and hold the  or  button on the multifunction steering wheel until the standard display appears in the multifunction display (▷ page 208).
- ▶ Press the  or  button until the Run Flat Indicator Active Menu: R-Button message appears in the multifunction display.
- ▶ Press the reset button (▷ page 28) on the instrument cluster.  
The Restart Run Flat Indicator? Yes Cancel message appears in the multifunction display.

#### If you wish to confirm the restart:

- ▶ Press the  button.  
The Run Flat Indicator Restarted message appears in the multifunction display.  
After a teach-in period, the tire pressure loss warning system will monitor the set tire pressures of all four tires.

#### If you wish to cancel the restart:

- ▶ Press the  button.  
or
- ▶ Wait until the Restart Run Flat Indicator? Yes Cancel message disappears.  
The tire pressure values stored at the last restart will continue to be monitored.

### Tire pressure monitoring system (USA only)

#### Important safety information

The tire pressure monitoring system consists of sensors installed in the vehicle wheels that monitor the air pressure in all four tires. The tire pressure monitoring system warns you when the pressure in one or more tires decreases. It only works when the

corresponding sensors are installed on all the wheels.

The tire pressure monitor informs you via a yellow warning lamp in the instrument cluster about pressure loss or if the system is malfunctioning. Whether the warning lamp flashes or lights up indicates whether a tire pressure is too low or the tire pressure monitor is malfunctioning:

- If the warning lamp is lit up constantly, one or more of your tires are significantly underinflated. The tire pressure monitor is not malfunctioning.
- If the warning lamp flashes for 60 seconds and is then lit constantly, the tire pressure monitor is malfunctioning.

#### Warning!

Each tire, including the spare (if provided), should be checked at least once a month when cold and inflated to the inflation pressure recommended by the vehicle manufacturer on the tire and loading information table on the driver's door B-pillar or the tire inflation pressure table on the inside of the fuel filler flap. If your vehicle has tires of a different size than the size indicated on the tire and loading information table or the tire inflation pressure table, you should determine the proper tire inflation pressure for those tires.

As an added safety feature, your vehicle has been equipped with a tire pressure monitor (TPMS). An indicator lamp lights up if one or more of your tires are significantly underinflated. Accordingly, when the low tire pressure indicator lamp lights up, you should stop and check your tires as soon as possible, and inflate them to the proper pressure. Driving on a significantly underinflated tire causes the tire to overheat and can lead to tire failure.

Underinflation also reduces fuel efficiency and tire tread life and may affect the vehicle's handling and stopping ability. Please note that the TPMS is not a substitute for proper tire maintenance and it is the driver's

responsibility to maintain correct tire pressure, even if underinflation has not reached the level at which the low tire pressure indicator lamp of the TPMS lights up. Your vehicle has also been equipped with a TPMS malfunction indicator to indicate when the system is not operating properly. The TPMS malfunction indicator is combined with the low tire pressure indicator lamp. When the system detects a malfunction, the indicator lamp will flash for approximately 1 minute and then remain illuminated. This sequence will continue upon subsequent vehicle start-ups as long as the malfunction exists. When the malfunction indicator is lit, the system may not be able to detect or signal low tire pressure as intended.

TPMS malfunctions may occur for a variety of reasons, including the installation of incompatible replacement or alternate tires or wheels on the vehicle that prevent the TPMS from functioning properly. Always check the TPMS malfunction indicator after replacing one or more tires or wheels on your vehicle to ensure that the replacement or alternate tires and wheels allow the TPMS to continue to function properly.

- i** If the tire pressure monitoring system malfunctions, it may take up to 10 minutes before the malfunction is displayed to you by the tire pressure warning lamp flashing for 60 seconds and then remaining lit. When the error has been rectified, the tire pressure warning lamp goes out after a few minutes of driving.





Information on tire pressures is displayed in the multifunction display. After a few minutes of driving, the current tire pressure of each tire is shown in the multifunction display.

- i** The tire pressure values in the on-board computer may deviate from the inflation pressure as measured using a tire pressure checker at the filling station. The tire pressures shown in the on-board computer refer to pressures at sea level. At high

altitudes, a tire pressure checker will display a higher tire pressure than the on-board computer. In this case do not reduce the tire pressure.

- i** If radio transmitting equipment (e.g. radio headphones, a two-way radio) is operated in or near the vehicle, this can lead to the function of the tire pressure monitor being impaired.
- i** This device complies with Part 15 of the FCC Rules. Operation is subject to the following two conditions:
  1. This device may not cause harmful interference, and
  2. This device must withstand any interference received, including interference that may cause undesired operation.
 Any unauthorized modification to this device could void the user's authority to operate the equipment.

### Checking the tire pressure electronically

- ▶ Make sure that the key is in position **2** (▷ page 139) in the ignition lock.
- ▶ Press and hold the  or  button on the multifunction steering wheel until the standard display appears in the multifunction display (▷ page 208).
- ▶ Press and hold the  or  button until the current tire pressure of each tire is shown in the multifunction display.

If the vehicle has been parked for longer than 20 minutes and subsequently you have not driven faster than 15 mph (25 km/h), the Tire pressure displayed after driving for a few minutes message is shown.

After a teach-in process, the tire pressure monitor automatically detects new wheels or new sensors. As long as it is not possible to allocate tire pressure values to individual wheel positions, the Tire Pressure

Monitor Active message appears instead of the tire pressure display. The tire pressures are already being monitored.

- i** If a spare wheel is installed, the system may continue to show the tire pressure of the wheel that has been removed for a few minutes. If this occurs, note that the value displayed for the position where the emergency spare wheel/spare wheel is installed is not the same as the current tire pressure for the spare wheel.

### TPMS warning messages

If the TPMS detects a significant pressure loss on one or more tires, a warning message is shown in the multifunction display. In addition, a warning tone sounds and the tire pressure warning lamp lights up in the instrument cluster.

Each tire in which a significant pressure loss has been detected is highlighted with a red triangle.

### Restarting the tire pressure monitoring system

#### Warning





It is the driver's responsibility to set the tire inflation pressure to the recommended cold tire inflation pressure. Underinflated tires affect the ability to steer or brake the vehicle. You might lose control over the vehicle.

When you restart the TPMS, all existing warning messages are deleted and the warning lamps go out. The currently set tire pressures are adopted as the specified values for monitoring.

The TPMS must be restarted when you set the tire pressure to a new value (as a result of changed handling or load characteristics, for example). The TPMS then monitors the new tire pressure values.

Restart the TPMS after the tire pressure has been set, as desired, according to the recommended values for the driving

conditions (▷ page 326). Only correct tire pressures on cold tires. Comply with the tire pressures recommended on the Tire and Loading Information placard on the B-pillar on the driver's side. Additional tire pressure values for driving at high speeds or with heavy loads can be found in the tire pressure table on the inside of the fuel filler flap.

- ▶ Make sure that the tire pressure is set properly in all four tires.
- ▶ Make sure that the key is in position **2** in the ignition lock.
- ▶ Press and hold the  or  button on the multifunction steering wheel until the standard display appears in the multifunction display (▷ page 208).
- ▶ Press and hold the  or  button until the tire pressure of all tires or the Tire pressure displayed after driving for a few minutes. message is shown.
- ▶ Press the reset button on the instrument cluster (▷ page 28).  
The Restart tire pressure monitor? Yes Cancel message appears in the multifunction display.

- ▶ **To confirm selection:** press the  button.

The Tire Pressure Monitor Restarted message appears in the multifunction display.

After driving for a few minutes, the system confirms that the current tire pressure values are within the specified range. The new tire pressure values are then accepted as reference values and monitored.

- ▶ **To cancel restart:** press the  button.

- i** If the positions of the wheels on the vehicle have been changed, the tire pressure may be shown in the wrong position briefly. This will be corrected after driving for a few minutes and the tire pressure will be displayed in the correct position.

## Maximum tire pressures

### Warning

Never exceed the maximum tire inflation pressure. Follow recommended tire inflation pressures.

Do not underinflate tires. Underinflated tires wear excessively and/or unevenly, adversely affect handling and fuel economy, and are more likely to fail from being overheated.

Do not overinflate tires. Overinflated tires can adversely affect handling and ride comfort, wear unevenly, increase stopping distance, and result in sudden deflation (blowout) because they are more likely to become punctured or damaged by road debris, potholes etc.

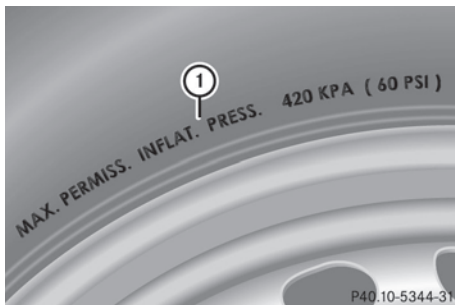

① Maximum permitted tire pressure (example)

**i** The actual values for tires are specific to each vehicle and may deviate from the values in the illustration.

When adjusting the tire pressures always observe the recommended tire pressure for your vehicle (▷ page 326).

## Loading the vehicle

### Instruction labels for tires and loads

### Warning

Do not overload the tires by exceeding the specified load limit as indicated on the Tire and Loading Information placard on the

driver's door B-pillar. Overloading the tires can overheat them, possibly causing a blowout. Overloading the tires can also result in handling or steering problems, or brake failure.

Two instruction labels on your vehicle show the maximum possible load.

- (1) The Tire and Loading Information placard on the B-pillar on the driver's side. The Tire and Loading Information placard shows the maximum possible number of occupants and the maximum possible vehicle load. It also contains details of the tire sizes and corresponding pressures for tires installed at the factory.
- (2) The vehicle identification plate is on the B-pillar on the driver's side. The vehicle identification plate informs you of the gross vehicle weight rating. It is made up of the vehicle weight, all vehicle occupants, the fuel and the cargo. You can also find information about the maximum gross axle weight rating on the front and rear axle.

The maximum gross axle weight rating is the maximum weight that can be carried by one axle (front or rear axle). Never exceed the maximum load or the maximum gross axle weight rating for the front or rear axle.

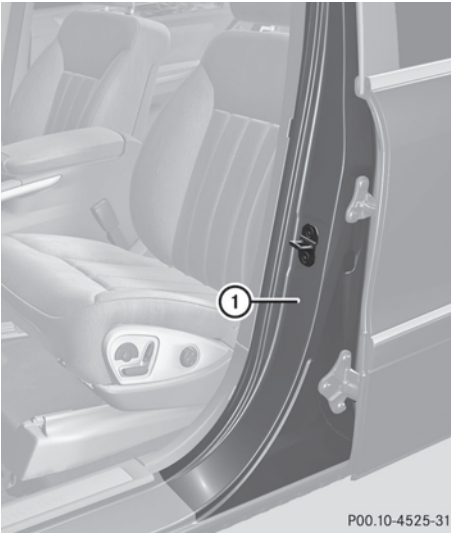

① B-pillar, driver's side

### Maximum permissible gross vehicle weight rating

Details that are shown as examples on the Tire and Loading Information placard are only examples. The maximum permissible gross vehicle weight rating is vehicle-specific and may differ from that which is illustrated. You can find the valid maximum permissible gross vehicle weight rating for your vehicle on the Tire and Loading Information placard.

TIRE RENSEIGNEMENTS POUR LES PNEUS ET LE CHARGEMENT		LOADING INFORMATION	
SEATING CAPACITY / NOMBRE DE SIÈGES	TOTAL	FRONT / AVANT	MIDDLE / MILIEU
7	7	2	2
The combined weight of occupants and cargo should never exceed XXXX kg or XXXX lbs.* Le poids total des occupants et des marchandises ne doit jamais dépasser XXXX kg ou XXXX lb.*			
TIRE PNEU	SIZE TAILLE	COLD TIRE PRESSURE / PRESSION DES PNEUS À FROID	
FRONT / AVANT	255/40 ZR18 99Y XL	200 KPA, 29 PSI	
REAR / ARRIÈRE	286/35 ZR18 101Y XL	200 KPA, 29 PSI	
SPARE / DE RECHANGE	175/55-18 95P	420 KPA, 60 PSI	

P40.00-2131-31

▶ The Tire and Loading Information placard gives you details on maximum permissible gross vehicle weight rating ①: "The gross

weight of occupants and luggage must never exceed XXX kilograms or XXX pounds."

The gross weight of all vehicle occupants, cargo, luggage and trailer load/noseweight (if applicable) must not exceed the specified value.

### Number of seats

Details that are shown as examples on Tire and Loading Information placard are only examples. The number of seats is vehicle-specific and can differ from the details shown. The number of seats in your vehicle can be found on the Tire and Loading Information placard.

TIRE RENSEIGNEMENTS POUR LES PNEUS ET LE CHARGEMENT		LOADING INFORMATION	
SEATING CAPACITY / NOMBRE DE SIÈGES	TOTAL	FRONT / AVANT	MIDDLE / MILIEU
7	7	2	2
The combined weight of occupants and cargo should never exceed XXXX kg or XXXX lbs.* Le poids total des occupants et des marchandises ne doit jamais dépasser XXXX kg ou XXXX lb.*			
TIRE PNEU	SIZE TAILLE	COLD TIRE PRESSURE / PRESSION DES PNEUS À FROID	
FRONT / AVANT	255/40 ZR18 99Y XL	200 KPA, 29 PSI	
REAR / ARRIÈRE	286/35 ZR18 101Y XL	200 KPA, 29 PSI	
SPARE / DE RECHANGE	175/55-18 95P	420 KPA, 60 PSI	

P40.00-2132-31

Maximum number of seats ① determines the maximum number of occupants allowed to travel in the vehicle. This information can be found on Tire and Loading Information placard.

### Steps for determining the maximum cargo

The following steps have been developed as required of all manufacturers under Title 49, Code of U.S. Federal Regulations, Part 575 pursuant to the "National Traffic and Motor Vehicle Safety Act of 1966".

- ▶ **Step 1:** Locate the statement "The combined weight of occupants and cargo should never exceed XXX kg or XXX lbs." on your vehicle's Tire and Loading Information placard.
- ▶ **Step 2:** Determine the combined weight of the driver and passengers that will be traveling in your vehicle.
- ▶ **Step 3:** Subtract the combined weight of the driver and passengers from XXX kilograms or XXX lbs.
- ▶ **Step 4:** The resulting figure equals the available amount of cargo and luggage load capacity. For example, if the "XXX" amount equals 1400 lbs and there will be five 150 lbs passengers in your vehicle, the amount of available cargo and luggage load capacity is 650 lbs (1400 - 750 (5 x 150) = 650 lbs).
- ▶ **Step 5:** Determine the combined weight of luggage and cargo being loaded on the vehicle. For reasons of safety, that weight must not exceed the available cargo and luggage cargo capacity calculated in step 4.
- ▶ **Step 6 (if applicable):** If you intend to tow a trailer behind your vehicle, the load on the trailer is transferred to your vehicle. Consult this manual to determine how this reduces the available cargo and luggage load capacity of your vehicle (▷ page 338).

The following table shows examples on how to calculate total load and cargo capacities with varying seating configurations and number and size of occupants. The following examples use a cargo limit of 1 500 lbs (680 kg). **This is for illustration purposes only.** Make sure you always use the actual load limit for your vehicle stated on the vehicle's Tire and Loading Information placard (▷ page 335).

		Example 1	Example 2	Example 3
Step 1	Combined maximum weight of occupants and cargo (data from the Tire and Loading Information placard)	1500 lbs (680 kg)	1500 lbs (680 kg)	1500 lbs (680 kg)

		Example 1	Example 2	Example 3
Step 2	Number of people in the vehicle (driver and occupants)	5	3	1
	Distribution of the occupants	Front: 2 Rear: 3	Front: 1 Rear: 2	Front: 1

		Example 1	Example 2	Example 3
	<b>Weight of the occupants</b>	Occupant 1: 150 lbs (68 kg) Occupant 2: 180 lbs (82 kg) Occupant 3: 160 lbs (73 kg) Occupant 4: 140 lbs (63 kg) Occupant 5: 120 lbs (54 kg)	Occupant 1: 200 lbs (91 kg) Occupant 2: 190 lbs (86 kg) Occupant 3: 150 lbs (68 kg)	Occupant 1: 150 lbs (68 kg)
	<b>Gross weight of all occupants</b>	750 lbs (340 kg)	540 lbs (245 kg)	150 lbs (68 kg)

		Example 1	Example 2	Example 3
<b>Step 3</b>	<b>Permissible cargo and trailer load/noseweight (maximum gross vehicle weight rating from the Tire and Loading Information placard minus the gross weight of all occupants)</b>	1500 lbs (680 kg) - 750 lbs (340 kg) = 750 lbs (340 kg)	1500 lbs (680 kg) - 540 lbs (245 kg) = 960 lbs (435 kg)	1500 lbs (680 kg) - 150 lbs (68 kg) = 1350 lbs (612 kg)

The greater the combined weight of the occupants, the lower the maximum luggage load. Further information can be found under "Towing a trailer" (▷ page 338).

### Vehicle identification plate

Even if you have calculated the total cargo carefully, you should still make sure that the gross vehicle weight rating and the gross axle weight rating are not exceeded. Details can be found on the vehicle identification plate on the B-pillar on the driver's side (▷ page 334).

**Gross vehicle weight:** the gross weight of the vehicle, all passengers, cargo and trailer load/noseweight (if applicable) must not exceed the permissible gross vehicle weight.

**Gross axle weight rating:** the maximum permissible load that can be carried by one axle (front or rear axle).

To ensure that your vehicle does not exceed the maximum permissible values (gross vehicle weight and maximum gross axle weight rating), have your loaded vehicle (including driver, occupants, cargo, and full trailer load if applicable) weighed on a suitable vehicle weighbridge.

### Trailer load/noseweight

The trailer load/noseweight affects the gross weight of the vehicle. If a trailer is attached, the trailer load/noseweight is included in the load along with occupants and luggage. The trailer load/noseweight is usually approximately 8% - 15% of the gross weight of the trailer and its cargo.

### Maximum tire load

#### Warning

Do not overload the tires by exceeding the specified load limit as indicated on the Tire and Loading Information placard on the driver's door B-pillar. Overloading the tires can overheat them, possibly causing a blowout. Overloading the tires can also result in handling or steering problems, or brake failure.



- i** The actual values for tires are specific to each vehicle and may deviate from the values in the illustration.

Maximum tire load ① is the maximum permitted weight for which the tire is approved.

Further information on tire loads  
(▷ page 340).

### Direction of rotation

Tires with a specified direction of rotation have additional benefits, e.g. if there is a risk of hydroplaning. You will only gain these benefits if the correct direction of rotation is observed.

An arrow on the sidewall of the tire indicates its correct direction of rotation.

You may mount an emergency spare wheel/spare wheel against the direction of rotation. Observe the time restriction on use as well as the speed limitation specified on the emergency spare wheel/spare wheel.

### Uniform Tire Quality Grading Standards

#### Overview of tire quality standards

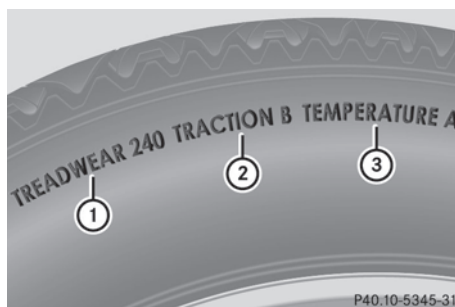

The Uniform Tire Quality Grading Standards are U.S. government specifications. Their purpose is to provide drivers with uniform reliable information on tire performance data. Tire manufacturers grade tires using three performance factors: tread wear ①, tire traction ② and heat resistance ③. All tires sold in North America are provided with the corresponding quality class mark on the sidewall of the tire, even though these regulations do not apply to Canada.

- i** The actual values for tires are specific to each vehicle and may deviate from the values in the illustration.

Quality grades can be found, where applicable, on the tire sidewall between the tread shoulder and maximum tire width.

For example:

Tread wear	Traction	Temperature
200	AA	A

All passenger car tires must conform to U.S. federal safety requirements in addition to these grades.

### Tread wear

The tread wear grade is a comparative rating based on the wear rate of the tire when tested under controlled conditions on a specified U.S. government test track. For example, a tire graded 150 would wear one and one-half times as well on the government test track as a tire graded 100.

The relative performance of tires depends upon the actual conditions of their use, however, and may depart significantly from the norm due to variations in driving habits, service practices and differences in road characteristics and climate conditions.

### Traction

#### Warning

The traction grade assigned to this tire is based on straight-ahead braking traction tests, and does not include acceleration, cornering, hydroplaning, or peak traction characteristics.

The traction grades, from highest to lowest, are AA, A, B, and C. These grades represent the tire's ability to stop on a wet surface as measured under controlled conditions on specified government test surfaces of asphalt and concrete. A tire marked C may have poor traction performance.

#### Warning

If ice has formed on the road, tire traction will be substantially reduced. Under such weather conditions, drive, steer and brake with extreme caution.

The safe speed on a wet, snow covered or icy road is always lower than on dry road surfaces.

You should pay special attention to road conditions when temperatures are around the freezing point.

Mercedes-Benz recommends a minimum tire tread depth of 1/6 in (4 mm) for all four winter tires (▷ page 165) to maintain normal driving characteristics in winter. Winter tires can reduce the braking distance on snow covered surfaces in comparison to summer tires. The braking distance is still much further than on surfaces that are not icy or covered with snow. Take appropriate care when driving.

**!** Avoid wheelspin. This can lead to damage to the drive train which is not covered by the Mercedes-Benz warranty conditions.

### Temperature

#### Warning

The temperature grade for this tire is established for a tire that is properly inflated and not overloaded. Excessive speed, underinflation, or excessive loading, either separately or in combination, can cause excessive heat build-up and possible tire failure.

The temperature grades are A (the highest), B, and C, representing the tire's resistance to the generation of heat and its ability to dissipate heat when tested under controlled conditions on a specified indoor laboratory test wheel. Sustained high temperature can cause the material of the tire to degenerate and reduce tire life, and excessive temperature can lead to sudden tire failure. The grade C corresponds to a level of

performance which all passenger car tires must meet under the Federal Motor Vehicle Safety Standard No. 109. Grades B and A represent higher levels of performance on the laboratory test wheel than the minimum required by law.

## Interchanging the wheels

### Warning

Rotate front and rear wheels only if the tires are of the same dimension.

If your vehicle is equipped with mixed-size tires (different tire dimensions front vs. rear), tire rotation is not possible.

### Warning!

Have the tightening torque checked after changing a wheel. The wheels could come loose if they are not tightened to a torque of 110 lb-ft (150 Nm).

Only use genuine Mercedes-Benz wheel bolts specified for your vehicle's rims.

The wear patterns on the front and rear tires differ, depending on the operating conditions. Rotate the wheels before a clear wear pattern has formed on the tires. Front tires typically wear more on the shoulders and the rear tires in the center.

If your vehicle's tire configuration allows, you can rotate the wheels according to the intervals in the tire manufacturer's warranty book in your vehicle documents. If no warranty book is available, the tires should be rotated every 3000 to 6000 miles (5000 to 10000 km), or earlier if tire wear requires. Do not change the direction of wheel rotation.

Clean the contact surfaces of the wheel and the brake disc thoroughly every time a wheel is rotated. Check the tire pressures.

Information on changing a wheel and mounting the spare wheel (▷ page 305).

## Tire labeling

### Overview of tire labeling

The following markings are on the tire in addition to the tire name (sales designation) and the manufacturer's name:

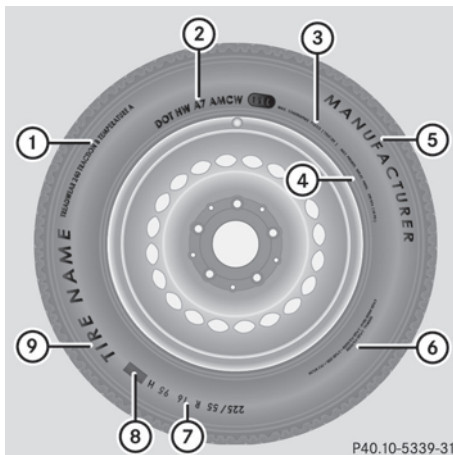

- ① Uniform Tire Quality Grading Standard (▷ page 344)
- ② DOT, Tire Identification Number (▷ page 343)
- ③ Maximum tire load (▷ page 338)
- ④ Maximum tire pressure (▷ page 334)
- ⑤ Manufacturer
- ⑥ Tire material (▷ page 344)
- ⑦ Tire size designation, load-bearing capacity and speed index (▷ page 341)
- ⑧ Load index (▷ page 343)
- ⑨ Tire name

**i** Tire data is vehicle-specific and may deviate from the data in the example.

### Tire size designation, load-bearing capacity and speed index

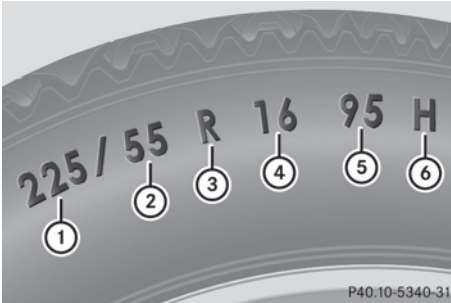

- ① Tire width
- ② Aspect ratio in percent
- ③ Tire code
- ④ Rim diameter
- ⑤ Load bearing index
- ⑥ Speed index

**i** Tire data is vehicle-specific and may deviate from the data in the example.

**General:** depending on the manufacturer's standards, the size imprinted in the tire wall may not contain any letters or may contain one letter that precedes the size description. If there is no letter preceding the size description (as shown above): passenger vehicle tires according to European manufacturing standards.

If "P" precedes the size description: passenger vehicle tires according to U.S. manufacturing standards.

If "LT" precedes the size description: light truck tires according to U.S. manufacturing standards.

If "T" precedes the size description: compact emergency spare wheels at high tire pressure, only for temporary use in an emergency.

**Tire width:** tire width ① shows the nominal tire width in millimeters.

**Aspect ratio:** aspect ratio ② is relationship between tire height and tire width and is specified in percent. The aspect ratio is

calculated by dividing the tire width by the tire height.

**Tire code:** tire code ③ specifies the tire type. "R" represents radial tires. "D" represents diagonal tires, "B" represents diagonal radial tires.

Optionally, tires with a maximum speed of over 149 mph (240 km/h) may have "R" in the size description depending on the manufacturer (e.g. 245/40 ZR 18).

**Rim diameter:** rim diameter ④ is the diameter of the bead seat, not the diameter of the rim flange. The rim diameter is specified in inches (in).

**Load bearing index:** load bearing index ⑤ is a numerical code that specifies the maximum load-bearing capacity of a tire.

#### Warning

The tire load rating must always be at least half of the GAWR of your vehicle. Otherwise, sudden tire failure may be the result which could cause an accident and/or serious injury to you or others.

Always replace rims and tires with rims and tires having the same specifications (designation, manufacturer and type) as shown on the original part.

#### Warning

Do not overload the tires by exceeding the specified load limit as indicated on the Tire and Loading Information placard on the driver's door B-pillar. Overloading the tires can overheat them, possibly causing a blowout. Overloading the tires can also result in handling or steering problems, or brake failure.

Example:

The load bearing index 91 is equivalent to a maximum load of 1356 lbs (615 kg) that the tire can carry. For further information on the maximum tire load in kilograms and pounds, see (▷ page 338).

For further information on the load bearing index, see load index (▷ page 343).

**Speed index:** speed index ⑥ specifies the approved maximum speed of the tire.

#### Warning

Even when permitted by law, never operate a vehicle at speeds greater than the maximum speed rating of the tires.

Exceeding the maximum speed for which tires are rated can lead to sudden tire failure, causing loss of vehicle control and possibly resulting in an accident and/or serious personal injury and possible death, for you and for others.

Regardless of the speed index always observe the speed limits. Drive carefully and adapt your driving style to the traffic conditions.

#### Summer tires

Index	Speed rating
Q	up to 100 mph (160 km/h)
R	up to 106 mph (170 km/h)
S	up to 112 mph (180 km/h)
T	up to 118 mph (190 km/h)
H	up to 130 mph (210 km/h)
V	up to 149 mph (240 km/h)
W	up to 168 mph (270 km/h)
Y	up to 186 mph (300 km/h)
ZR...Y	up to 186 mph (300 km/h)
ZR...(..Y)	above 186 mph (300 km/h)
ZR	above 149 mph (240 km/h)

- Optionally, tires with a maximum speed of over 149 mph (240 km/h) may have "ZR" in the size description depending on the manufacturer (e.g. 245/40 ZR 18).

The service specifications consists of load bearing index ⑤ and speed index ⑥.

- If the size description of your tire includes "ZR" and there are no service specifications, ask the tire manufacturer in order to find out the maximum speed.



If a service specification is available, the maximum speed is limited according to the speed index in the service specification.

Example: 245/40 ZR18 97 Y. In this example, "97Y" is the service specification. The letter "Y" represents the speed index and the maximum speed of the tire is limited to 186 mph (300 km/h).

- Every tire that has a maximum speed above 186 mph (300 km/h) must have "ZR" in the size description **and** the service specification must be given in brackets. Example: 275/40 ZR 18 (99 Y). The speed index "(Y)" shows that the maximum speed of the tire is above 186 mph (300 km/h). Ask the tire manufacturer to find out the maximum speed.

#### All-weather tires and winter tires

Index	Speed rating
Q M+S <sup>54</sup>	up to 100 mph (160 km/h)
T M+S <sup>54</sup>	up to 118 mph (190 km/h)
H M+S <sup>54</sup>	up to 130 mph (210 km/h)
V M+S <sup>54</sup>	up to 149 mph (240 km/h)

-  Not all tires that have the M+S identification offer the driving characteristics of winter tires. Winter tires have, in addition to the M+S identification, the  snowflake symbol on the tire sidewall. Tires with this identification fulfill the requirements of the Rubber Manufacturers Association (RMA) and the Rubber Association of Canada (RAC) regarding the tire traction on snow and

<sup>54</sup> or M+S  for winter tires.

have been especially developed for driving on snow.

An electronic speed limiter prevents your vehicle from exceeding the following speeds:

- All vehicles (except AMG vehicles): 130 mph (210 km/h)
- AMG vehicles: 155 mph (250 km/h)
- AMG vehicles with raised maximum speed: 171 mph (275 km/h)

The speed index of tires installed at the factory may be higher than the maximum speed that the electronic speed limiter permits.

Make sure that your tires have the required speed index as specified in the "Tires" section (▷ page 347) for your vehicle, e.g. when buying new tires.

More information on reading the tire data can be obtained at any qualified specialist workshop, e.g. at an authorized Mercedes-Benz Center.

### Load index



- **i** Tire data is vehicle-specific and may deviate from the data in the example.

In addition to the load bearing index, load index ① may be imprinted after the letters that identify speed index ⑥ (▷ page 341) on the sidewall of the tire.

- If no specification is given: no text (as in the example above), represents a standard load (SL) tire
- XL or Extra Load: represents a reinforced tire
- Light load: represents a light load tire
- C, D, E: represents a load range that depends on the maximum load that the tire can carry at a certain pressure

### DOT, Tire Identification Number (TIN)

U.S. tire regulations prescribe that every new tire manufacturer or retreader has to imprint a TIN in or on the sidewall of each tire produced.

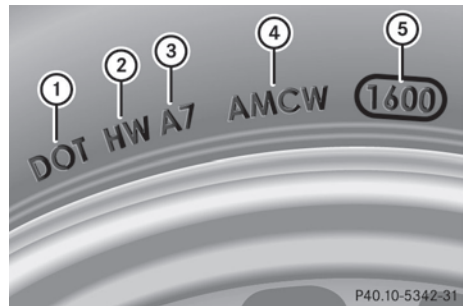

The TIN is a unique identification number. The TIN enables the tire manufacturers to inform purchasers of recalls and other safety-relevant matters. It makes it possible for the purchaser to easily identify the affected tires. The TIN is made up of manufacturer identification code ②, tire size ③, tire type code ④ and date of manufacture ⑤.

- **i** Tire data is vehicle-specific and may deviate from the data in the example.

**DOT (Department of Transportation):** tire symbol ① marks that the tire complies with the requirements of the U.S. Department of Transportation.

**Manufacturer identification code:** manufacturer identification code ② provides details on the tire manufacturer. New tires

have a code with two symbols. Retreaded tires have a code with four symbols.

Further information about retreaded tires (▷ page 324).

**Tire size:** identifier ③ describes the tire size.

**Tire type code:** tire type code ④ can be used by the manufacturer as a code to describe specific characteristics of the tire.

**Date of manufacture:** date of manufacture ⑤ provides information about the age of a tire. The first and second positions represent the week of manufacture, starting with "01" for the first calendar week. Positions three and four represent the year of manufacture. For example, a tire that is marked with "3208", was manufactured in week 32 in 2008.

### Bar

Metric unit for tire pressure. 14.5038 pounds per square inch (psi) and 100 kilopascals (kPa) are the equivalent of 1 bar.

### DOT (Department of Transportation)

DOT marked tires fulfill the requirements of the United States Department of Transportation.

### Average weight of the vehicle occupants

The number of occupants for which the vehicle is designed multiplied by 68 kilograms (150 lb).

### Characteristics of the tire

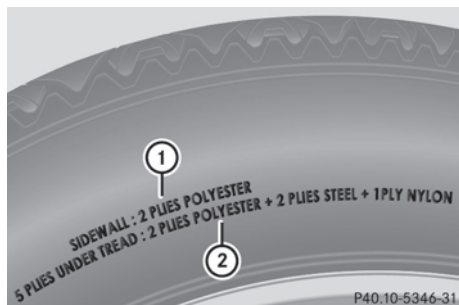

**i** Tire data is vehicle-specific and may deviate from the data in the example.

This information describes the tire cord and the number of layers in sidewall ① and under tire tread ②.

## Definitions for tires and loading

### Structure and condition of the tire

Describes the number of layers or the number of rubber-coated belts in the tire tread and the tire wall. These are made of steel, nylon, polyester and other materials.

### Uniform Tire Quality Grading Standards

A uniform standard to grade the quality of tires with regards to tread quality, tire traction and temperature characteristics. The quality grading assessment is made by the manufacturer following specifications from the U.S. government. The quality grade of a tire is imprinted on the sidewall of the tire.

### Recommended tire pressure

The recommended tire pressure for your vehicle under normal driving conditions. You will find the recommendation on the Tire and Loading Information placard on the B-pillar on the driver's side of your vehicle. The recommended tire pressure provides the best balance between handling characteristics, ride comfort and wear. Additional information on particular driving conditions is located on the tire pressure table on the inside of the fuel filler flap.

### Increased vehicle weight due to optional equipment

The combined weight of all standard and optional equipment available for the vehicle, regardless of whether it is actually installed on the vehicle or not.

### Wheel rim

The part of the wheel on which the tire is mounted.

### GAWR (Gross Axle Weight Rating)

The GAWR is the maximum gross axle weight rating. The actual load on an axle must never exceed the gross axle weight rating. The gross axle weight rating can be found on the vehicle identification plate on the B-pillar on the driver's side.

### Speed index

The speed index is part of the tire identification. Specifies the speed range for which the tire is approved.

### GTW (Gross Trailer Weight)

The GTW is the weight of a trailer including the weight of the load, luggage, accessories etc. on the trailer.

### GVW (Gross Vehicle Weight)

The gross vehicle weight includes the weight of the vehicle including fuel, tools, the spare wheel, accessories installed, occupants, luggage and the drawbar noseweight if applicable. The gross vehicle weight must not exceed the gross vehicle weight rating GVWR as specified on the vehicle identification plate on the B-pillar on the driver's side.

### GVWR (Gross Vehicle Weight Rating)

The GVWR is the maximum permissible gross weight of a fully loaded vehicle (the weight of the vehicle including all accessories, occupants, fuel, luggage and the drawbar noseweight if applicable). The gross vehicle weight rating is specified on the vehicle identification plate on the B-pillar on the driver's side.

### Maximum weight of the laden vehicle

The maximum weight is the sum of the unladen weight of the vehicle, the weight of the accessories, the maximum load and the weight of the optional equipment installed at the factory.

### Kilopascal (kPa)

Metric unit for tire pressure. 6.9 kPa is the equivalent of 1 psi. Another unit for tire pressure is bar. 100 kilopascal (kPa) is the equivalent of 1 bar.

### Load index

In addition to the load bearing index, the load index may also be imprinted on the sidewall of the tire. This specifies the load bearing capacity more precisely.

### Unladen weight

The weight of a vehicle with standard equipment including the maximum capacity of fuel, oil and coolant. It also includes the air-conditioning system and optional equipment if these are installed on the vehicle, but does not include passengers or luggage.

**Maximum tire load**

The maximum tire load in kilograms or pounds is the maximum weight for which a tire is approved.

**Maximum permissible tire pressure**

Maximum permissible tire pressure for one tire.

**Maximum load on one tire**

Maximum load on one tire. This is calculated by dividing the maximum axle load of one axle by two.

**PSI (pounds per square inch)**

Standard unit of measurement for tire pressure.

**Aspect ratio**

Relationship between tire height and tire width in percent.

**Tire pressure**

Pressure inside the tire applying an outward force to every square inch of the tire's surface. The tire pressure is specified in pounds per square inch (psi), in kilopascal (kPa) or in bar. The tire pressure should only be corrected when the tires are cold. For this, the vehicle must have been stationary for at least three hours or not have traveled more than 1.6 km (1 mile) in this time.

**Tire tread**

The part of the tire that comes into contact with the road.

**Tire bead**

The tire bead contains steel wire which is bound by steel cords that hold the tire on the wheel rim.

**Sidewall**

The part of the tire between the tread and the tire bead.

**Weight of optional extras**

The combined weight of those optional extras that weigh more than the replaced standard part and more than 2.3 kilograms (5 lbs). These optional extras, such as high-performance brakes, level control, a roof rack or a high-performance battery, are not included in the unladen weight and the weight of the accessories.

**TIN (Tire Identification Number)**

A unique identification number which can be used by a tire manufacturer to identify tires, for example for a product recall, and thus identify the purchasers. The TIN is made up of the manufacturer's identity code, tire size, tire type code and the manufacturing date.

**Load bearing index**

The load bearing index (also load index) is a code that contains the maximum load bearing capacity of a tire.

**Traction**

Traction is the result of friction between the tires and the road surface.

### TWR (permissible trailer drawbar noseweight)

The TWR is the maximum permissible weight that the ball coupling of the trailer tow hitch can support.

### Wear indicator

Narrow bars (tread wear bars) that are distributed over the tire tread. If the tire tread is level with the bars, the wear limit of  $\frac{1}{16}$  in (1.6 mm) has been reached.

### Distribution of the vehicle occupants

Distribution of vehicle occupants over designated seat positions in a vehicle.

### Maximum permissible payload weight

Nominal load and luggage load plus 68 kilograms (150 lb) multiplied by the number of seats in the vehicle.

## Wheel/tire combinations

### Points to remember

#### Warning

Observe the "Important safety information" (> page 324).

- !** For safety reasons, Mercedes-Benz recommends that you only use tires, wheels and accessories which have been approved by Mercedes-Benz specifically for your vehicle. These tires have been specially adapted for use with the control systems, such as ABS or ESP<sup>®</sup>, and are marked as follows:
- MO = Mercedes-Benz Original
  - MOE = Mercedes-Benz Original Extended (tires with run-flat characteristics)
  - MO1 = Mercedes-Benz Original (AMG)

Only use Mercedes-Benz Original Extended tires on wheels that have been specifically approved by Mercedes-Benz.

If you use other tires, wheels and accessories, Mercedes-Benz cannot accept any responsibility for damage that may result from this. Further information about tires, wheels and approved combinations can be obtained from any authorized Mercedes-Benz Center.

- !** If you mount tires other than those tested and recommended by Mercedes-Benz, characteristics such as handling, noise levels and fuel consumption, etc. may be adversely affected. In addition, when driving with a load, tire dimensional variations could cause the tires to come into contact with the bodywork and axle components. This could result in damage to the tires or the vehicle.

- i** Further information about tires and wheels can be obtained from any authorized Mercedes-Benz Center.
- i** The Tire and Load Information placard with the recommended tire pressures is attached to the B-pillar on the driver's side. Further information about driving at high speeds or driving with vehicle loads that are lighter than the maximum vehicle load can be found in the tire pressure table on the inside of the fuel filler flap. Check tire pressures regularly, and only when the tires are cold. Comply with the maintenance recommendations of the tire manufacturer in the vehicle document wallet.

Further information on the recommended tire inflation pressure and on tire pressures for specific driving conditions, see (> page 326).

- i** Notes on the vehicle equipment:
  - always mount tires of the same size on a given axle (left/right).
  - always mount the same type of tires on your vehicle at a given time (summer tires, winter tires, MOExtended tires).

- i** Vehicles featuring the MOExtended run-flat system are not equipped with a TIREFIT kit.

It is therefore recommended that you additionally equip your vehicle with the TIREFIT kit if you mount tires that do not feature run-flat properties, e.g. winter tires.

A TIREFIT kit is available from any qualified specialist workshop, e.g. an authorized Mercedes-Benz Center.



- i** The following pages contain information on approved wheel rims and tire sizes for equipping your vehicle with winter tires. Winter tires are not available at the factory as standard equipment or as an optional extra.

If you want to equip your vehicle with approved winter tires, it may be necessary to obtain wheel rims in the corresponding size, as the size of the approved winter tires may differ from the standard tires. This is dependent on the model and the equipment installed at the factory.

Tires, wheel rims and further information can be obtained at a qualified specialist workshop, e.g. an authorized Mercedes-Benz Center.

## Tires of the same dimensions

**i** BA: Both axles

			<b>ML 350 4MATIC<sup>55</sup></b>	<b>ML 350<sup>56</sup></b>
R17	BA	<b>Alloy wheels Offset</b>	7.5 J x 17 H2 2.20 in (56 mm)	7.5 J x 17 H2 2.20 in (56 mm)
		<b>All-weather tires</b>	235/65 R17 104 H M+S	—
		<b>Winter tires<sup>57</sup></b>	235/65 R17 104 H M+S 	235/65 R17 104 H M+S 

			<b>ML 350 ML 350 BlueTEC 4MATIC ML 350 4MATIC<sup>58</sup></b>
R18	BA	<b>Alloy wheels Offset</b>	8 J x 18 H2 2.36 in (60 mm)
		<b>Winter tires<sup>57</sup></b>	255/55 R18 105 H M+S 
		<b>All-terrain tires<sup>57</sup></b>	255/55 R18 105 H M+S

			<b>ML 550 4MATIC</b>
R18	BA	<b>Alloy wheels Offset</b>	8 J x 18 H2 2.36 in (60 mm)
		<b>All-weather tires</b>	255/55 R18 105 H M+S
		<b>Winter tires<sup>57</sup></b>	255/55 R18 105 H M+S 
		<b>All-terrain tires<sup>57</sup></b>	255/55 R18 105 H M+S

<sup>55</sup> Canada only.

<sup>56</sup> USA only.

<sup>57</sup> Standard tires without run-flat characteristics, not available as standard equipment or optional equipment at the factory. Vehicles with MOExtended tires, retrofitting a TIREFIT kit is recommended.

<sup>58</sup> Also vehicles with the Sports package.

			<b>ML 350<sup>59, 60</sup></b> <b>ML 350 4MATIC<sup>59, 60</sup></b> <b>ML 350 BlueTEC 4MATIC<sup>61</sup></b> <b>ML 550 4MATIC<sup>60</sup></b>
R19	BA	<b>Alloy wheels Offset</b>	8 J x 19 H2 2.36 in (60 mm)
		<b>All-weather tires<sup>57</sup></b>	255/50 R19 107 H XL M+S
		<b>Winter tires<sup>57</sup></b>	255/50 R19 107 H XL M+S 

			<b>ML 350<sup>56</sup></b> <b>ML 350 4MATIC<sup>56</sup></b> <b>ML 350 BlueTEC 4MATIC<sup>56</sup></b> <b>ML 550 4MATIC<sup>56</sup></b>
R19	BA	<b>Alloy wheels Offset</b>	8 J x 19 H2 2.36 in (60 mm)
		<b>All-weather tires<sup>62</sup></b>	255/50 R19 107 H XL M+S MOExtended
		<b>Winter tires<sup>62, 63</sup></b>	255/50 R19 107 H XL M+S MOExtended 

			<b>ML 550 4MATIC<sup>64</sup></b>
R19	BA	<b>AMG alloy wheels Offset</b>	8.5 J x 19 H2 2.28 in (58 mm)
		<b>All-weather tires<sup>65</sup></b>	255/50 R19 107 H XL M+S
		<b>Winter tires<sup>63</sup></b>	255/50 R19 107 H XL M+S 

<sup>59</sup> USA only.

<sup>60</sup> Vehicles with the Sports package.

<sup>61</sup> Canada only.

<sup>57</sup> Standard tires without run-flat characteristics, not available as standard equipment or optional equipment at the factory. Vehicles with MOExtended tires, retrofitting a TIREFIT kit is recommended.

<sup>56</sup> USA only.

<sup>62</sup> Tires with run-flat characteristics must only be used in conjunction with an activated tire pressure loss warning system or TPMS.

<sup>63</sup> Not available as standard equipment or optional equipment at the factory.

<sup>64</sup> Vehicles with Appearance Package.

<sup>65</sup> Use of snow chains not permitted.

			<b>ML 63 AMG</b>
R19	BA	<b>AMG alloy wheels Offset</b>	9.5 J x 19 H2 2.81 in (46 mm)
		<b>Winter tires<sup>63</sup></b>	285/45 R19 107 H M+S 

			<b>ML 350<sup>66</sup> ML 350 4MATIC<sup>66</sup> ML 550 4MATIC</b>
R20	BA	<b>Alloy wheels Offset</b>	8.5 J x 20 H2 2.17 in (55 mm)
		<b>All-weather tires<sup>65</sup></b>	265/45 R20 108 H XL M+S

			<b>ML 550 4MATIC<sup>60</sup></b>
R20	BA	<b>AMG alloy wheels Offset</b>	8.5 J x 20 H2 2.36 in (60 mm)
		<b>All-weather tires<sup>65</sup></b>	265/45 R20 108 H XL M+S

			<b>ML 63 AMG</b>
R20	BA	<b>AMG alloy wheels Offset</b>	10 J x 20 H2 1.81 in (46 mm)
		<b>Summer tires<sup>65</sup></b>	295/40 ZR20 106 Y
		<b>Winter tires<sup>63, 65</sup></b>	295/40 R20 110 V XL M+S 

			<b>ML 63 AMG</b>
R21	BA	<b>AMG alloy wheels Offset</b>	10 J x 21 H2 1.81 in (46 mm)
		<b>Summer tires<sup>65</sup></b>	295/35 ZR21 107 Y XL

<sup>63</sup> Not available as standard equipment or optional equipment at the factory.

<sup>66</sup> Vehicles with Appearance Package.

<sup>65</sup> Use of snow chains not permitted.

<sup>60</sup> Vehicles with the Sports package.

**Spare wheel**

- i** Vehicles with MOExtended tires (tires with run-flat characteristics) are not equipped with TIREFIT at the factory.
- i** The ML 350 BlueTEC is not equipped with an emergency spare wheel.
- i** The prescribed tire pressure is also given on a yellow label on the emergency spare wheel.

**"Minispare" emergency spare wheel<sup>67</sup>**

		<b>ML 350, all models ML 550</b>
<b>R18</b>	<b>Wheels</b>	4.0 B x 18 H2
	<b>Offset</b>	1.58 in (40 mm)
	<b>Tires</b>	T 155/90 D18 113 M or T 155/90 R18 113 M
	<b>Tire pressure</b>	420 kPa (4.2 bar/61 psi)

**Collapsible emergency spare wheel<sup>67</sup>**

		<b>ML 63 AMG</b>
<b>R19</b>	<b>Wheels</b>	5.5 B x 19 H2
	<b>Offset</b>	0.51 in (13 mm)
	<b>Tires</b>	185/65-19 104 P
	<b>Tire pressure</b>	350 kPa (3.5 bar/51 psi)

<sup>67</sup> Use of snow chains not permitted.

<b>Vehicle equipment .....</b>	<b>354</b>
<b>Genuine Mercedes-Benz parts .....</b>	<b>354</b>
<b>Warranty .....</b>	<b>354</b>
<b>Vehicle identification plates .....</b>	<b>355</b>
<b>Service products and capacities .....</b>	<b>356</b>
<b>Vehicle data .....</b>	<b>363</b>

## Vehicle equipment

**i** This manual describes all the standard and optional equipment of your vehicle which was available at the time of purchase. Country-specific differences are possible. Bear in mind that your vehicle may not feature all functions described here. This also refers to safety-related systems and functions.

## Genuine Mercedes-Benz parts

All Mercedes-Benz Centers maintain a supply of genuine Mercedes-Benz parts for necessary service and repair work. In addition, strategically located parts delivery centers provide for quick and reliable parts service.

More than 300,000 different parts are available for Mercedes-Benz models.

Genuine Mercedes-Benz parts are subjected to stringent quality inspections. Every part has been specifically developed, manufactured or selected for and adapted to Mercedes-Benz vehicles.

Only genuine Mercedes-Benz parts should therefore be used.

**!** The use of non-approved parts could impair the vehicle's safety. For this reason, Mercedes-Benz recommends genuine Mercedes-Benz parts and approved conversion parts and accessories for your vehicle model.

### Environmental note

Daimler AG also supplies reconditioned major assemblies and parts which are of the same quality as new parts. They are covered by the same Limited Warranty entitlements as new parts.

Always specify the vehicle identification number and engine number when ordering

genuine Mercedes-Benz parts. You will find these numbers on your vehicle's identification plates, for example ( $\triangleright$  page 355).

## Warranty

Your vehicle is covered under the terms of the warranties printed in the Service and Warranty Information booklet.

Your authorized Mercedes-Benz Center will exchange or repair any defective parts originally installed in the vehicle in accordance with the terms of the following warranties:

- New Vehicle Limited Warranty
- Emission System Warranty
- Emission Performance Warranty
- California, Connecticut, Maine, Massachusetts, New York, Pennsylvania, Rhode Island and Vermont Emission Control Systems Warranty<sup>68</sup>
- State Warranty Enforcement Laws ("Lemon Laws")

Replacement parts and accessories are subject to the Mercedes-Benz Replacement Part and Accessory Warranties. You can obtain these at any Mercedes-Benz Center.

**i** Should you lose your Service and Warranty Information booklet, have an authorized Mercedes-Benz Center arrange for a replacement. It will be mailed to you.

<sup>68</sup> Only vehicles with a gasoline engine.

Vehicle identification plates

Vehicle identification plate with vehicle identification number (VIN) and paint code number

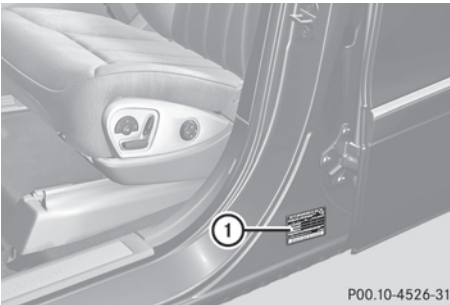

- ▶ Open the driver's door. You see vehicle identification plate ①.

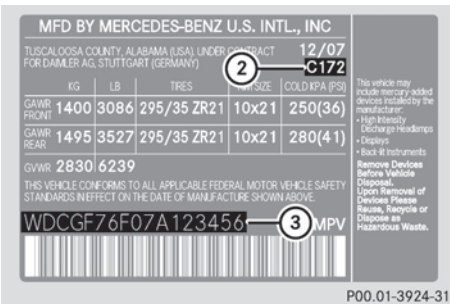

- Example: vehicle identification plate (USA only)
- ② Paint code number
- ③ VIN

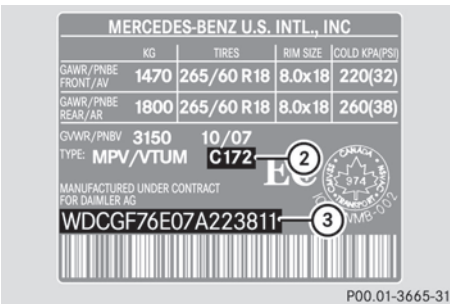

- Example: vehicle identification plate (Canada only)
- ② Paint code number
- ③ VIN

**i** The data on the type plate is only an example. This data is vehicle-specific and can differ from the data given here. The data that applies to your vehicle can be found on your vehicle's type plate.

Vehicle identification number (VIN)

The vehicle identification number (VIN) can be found in the following locations:

- on the vehicle identification plate (▶ page 355)
- on the lower edge of the windshield (▶ page 356)

In addition to being stamped on the vehicle identification plate, the vehicle identification number (VIN) is also stamped onto the vehicle body. It is located under the right-hand seat in the second row of seats.

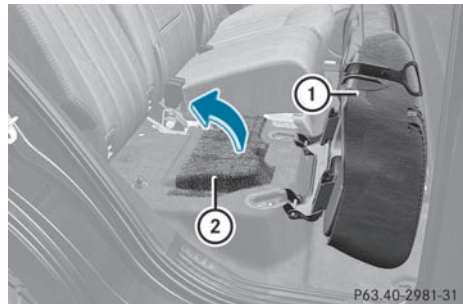

- ▶ Fold right seat ① forwards.
- ▶ Lift up carpet ②. You will see the vehicle identification number (VIN).

### Engine number

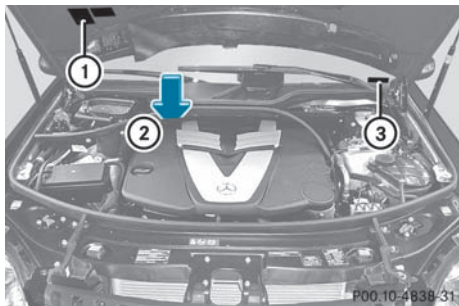

- ① Emissions control information label, including the certification of both federal and Californian emissions reference values
- ② Engine number (stamped into the crankcase)
- ③ VIN (on the lower edge of the windshield)

fluids. Otherwise, you could endanger persons or the environment.

Keep service fluids out of the reach of children.

For health reasons, you should prevent service fluids from coming into direct contact with your skin or clothing.

If a service fluid is swallowed, contact a physician immediately.

### Service products and capacities

#### Important safety guidelines

Service products include the following:

- fuels (e.g. gasoline, diesel)
- additives for exhaust gas aftertreatment (AdBlue®)
- lubricants (e.g. engine oil, transmission oil)
- coolant
- brake fluid
- windshield washer fluid

Vehicle components and their respective lubricants must match. You should therefore only use products that have been tested and approved by Mercedes-Benz.

Information on tested and approved products can be obtained at an authorized Mercedes-Benz Center or on the Internet at <http://www.mbusa.com> (USA only).

#### **Warning**

Comply with all valid regulations with respect to handling, storing and disposing of service

Capacities			
	Vehicle model	Capacity	Fuel, coolant, lubricants etc.
<b>Engine oil and filter</b>	ML 350 BlueTEC 4MATIC	9.0 US qt (8.5 l)	Approved engine oils
	ML 350 4MATIC ML 350	8.5 US qt (8.0 l)	
	ML 550 4MATIC	9.5 US qt (9.0 l)	
	ML 63 AMG <sup>69</sup>	10.3 US qt (9.7 l)	
<b>Power steering</b>	ML 350	Approx. 1.3 US qt (1.2 l)	MB Power Steering Fluid or approved Dexron III ATF
	ML 350 BlueTEC 4MATIC ML 350 4MATIC ML 550 4MATIC	Approx. 1.06 US qt (1.0 l)	MB Power Steering Fluid
	ML 63 AMG	Approx. 1.3 US qt (1.2 l)	
<b>Cooling system</b>	ML 350 BlueTEC 4MATIC ML 350 4MATIC ML 350	Approx. 10.0 US qt (9.5 l)	MB 325.0 Anticorrosion/ Antifreeze
	ML 550 4MATIC	Approx. 12.7 US qt (12.0 l)	
	ML 63 AMG	Approx. 12.2 US qt (11.5 l)	
<b>Tank capacity</b>	All models	25.1 US gal (95.0 l)	Gasoline engines: premium-grade unleaded gasoline (at least 91 octane, average value between 96 RON/86 MON)  Diesel engines: ULTRA-LOW SULFUR DIESEL FUEL (ULSD, maximum sulfur content 15 ppm)
<b>Reserve</b>	All models except AMG vehicles	Approx. 3.4 US gal (13.0 l)	
	ML 63 AMG	Approx. 4.0 US gal (15.0 l)	

<sup>69</sup> Includes external oil cooler.

	Vehicle model	Capacity	Fuel, coolant, lubricants etc.
<b>AdBlue® tank</b>	ML 350 BlueTEC 4MATIC	7.0 US gal (26.6 l)	AdBlue® as per ISO 22241
<b>Air-conditioning system</b>	All models	–	Refrigerant R134a and special PAG lubricant (never R 12)
<b>Windshield/headlamp cleaning system</b>	All models	7.6 US qt (7.2 l)	MB washer fluid concentrate <sup>70</sup> (▷ page 363) Mixing ratio for screen wash (▷ page 363)

## Fuel

### Important safety notes

#### **Warning!**

Gasoline and diesel fuels are highly flammable and poisonous. They burn violently and can cause serious injury.

Never allow sparks, flames or smoking materials near gasoline or diesel fuel!

Turn off the engine before refueling.

Whenever you are around gasoline or diesel fuel, avoid inhaling fumes and any skin or clothing contact. Extinguish all smoking materials.

Direct skin contact with fuels and the inhalation of fuel vapors are damaging your health.

If premium-grade unleaded gasoline is unavailable and regular gasoline is used, observe the following precautions:

- only fill the fuel tank to half full with regular unleaded gasoline and add the rest as soon as possible with premium-grade unleaded gasoline.
- do not drive at the maximum speed.
- avoid sudden acceleration.
- when the vehicle is carrying a light cargo, e.g. two passengers without luggage, do not allow the engine to rev above 3000 rpm.
- when the vehicle is fully loaded or being operated in mountainous terrain, do not depress the accelerator pedal further than  $\frac{2}{3}$  of the pedal travel.

### Premium-grade unleaded gasoline

**!** To ensure the longevity and full performance of the engine, only premium-grade unleaded gasoline must be used.

### Fuel requirements

#### Gasoline engines

Use only premium-grade unleaded gasoline. The octane number should be at least 91. Details can be found on the gas pump. The octane number is the average value of the Research Octane Number (RON) and Motor

<sup>70</sup> Mixed with water or premixed washer fluid with antifreeze protection.

Octane Number (MON):  $(RON + MON) / 2$ , also known as knock resistance.

Reformulated Gasoline (RFG) and/or unleaded gasoline with additives can be used if the concentration of the additives in the fuel does not exceed 10%, e.g.:

- Ethanol
- TAME
- ETBE
- IPA
- TBA

For MTBE, the concentration should not exceed 15%.

The concentration of methanol in gasoline including other additives must not exceed 3%.

Using mixtures of methanol and ethanol is not permitted. Gasohol, a mixture of 10% ethanol and 90% unleaded petrol can be used.

All of these mix fuels must fulfill the fuel requirements, e.g.:

- knock resistance
- boiling point
- vapor pressure

### Diesel engines – important safety information

**!** Only use commercially available ULTRA-LOW SULFUR DIESEL FUEL (ULSD, 15 ppm MAXIMUM SULFUR) that meets the ASTM D975 standard. Failure to use ULTRA-LOW SULFUR DIESEL FUEL (ULSD) can severely damage the vehicle's exhaust gas aftertreatment system.

**!** Do not fill the tank with gasoline. Do not blend diesel fuel with gasoline or kerosene. Otherwise, the fuel system and the engine will be damaged. Damage resulting from the use of gasoline or kerosene is not covered by the Mercedes-Benz Limited Warranty.

To prevent malfunctions, diesel fuel with improved flow characteristics is available in the winter months. Check with your fuel retailer.

Information on the fuel grade can usually be found on the gas pump. If the information cannot be found on the gas pump, ask service station personnel. For further information, contact an authorized Mercedes-Benz Center or visit <http://www.mbusa.com> (USA only).

### Diesel engines – Fuels containing bio-diesel (FAME [fatty acid methyl ester])

Mercedes-Benz USA approves the use of B5 (ULSD with a maximum of up to five percent by volume biodiesel) for all diesel engines with common rail direct injection (CDI) and BlueTEC.

Pure biodiesel and diesel fuels that contain a higher percentage of biodiesel, e.g. B20, may cause damage to the fuel system/engine and are, therefore, not approved.

For further information, please ask the service station personnel. The label on the gas pump must indicate clearly that the B5 biodiesel blend meets the ULSD standard. If the label is not clear, do not refuel the vehicle. The Mercedes-Benz Limited Warranty does not cover damages caused by the use of fuels not meeting Mercedes-Benz approved fuel standards.

### Additives in gasoline

One of the major problems in engine design is the creation of carbon deposits during the process of burning fuel. Mercedes-Benz recommends that you use fuel brands that have the additives which prevent the build up of carbon deposits.

If you use fuels without these additives for a longer period of time, there may be a build up of carbon deposits, especially on the inlet valves and in the combustion chamber.

This could lead to engine running problems, e.g.:

- warm-up hesitation
- unstable idle
- knocking/pinging

- misfire
- power loss

In areas where carbon deposits may be encountered due to lack of availability of gasoline which contains these additives, Mercedes-Benz recommends the use of additives approved for use in Mercedes-Benz vehicles.

Consult an authorized Mercedes-Benz Center or visit <http://www.mbusa.com> (USA only) to view a list of approved products. Observe the instructions for use on the product label. Do not mix other fuel additives with fuel. This causes unnecessary costs and could damage the engine.

**!** Do not refuel with low-grade fuel and do not use fuel additives that are not tested and approved for Mercedes-Benz vehicles. Damage or malfunctions can result that are not covered:

- by the Mercedes-Benz Limited Warranty
- by an existing Limited Warranty
- by an extended Limited Warranty

## AdBlue®

### Important safety guidelines

**i** For BlueTEC vehicles only.

AdBlue® is a non-flammable, non-toxic, colorless, odorless and water-soluble fluid.

**!** Only use AdBlue® that complies with ISO 22241. Do not add any special additives to AdBlue® and do not thin AdBlue® with water. This could destroy the BlueTEC exhaust gas aftertreatment.

**!** Rinse surfaces that have come into contact with AdBlue® immediately with water or remove AdBlue® using a damp cloth and cold water. If the AdBlue® has already crystallized, use a sponge and cold water to clean it. AdBlue® residues

crystallize after time and contaminate the affected surfaces.

### High outside temperatures

If AdBlue® is heated to above 122 °F (50 °C) for an extended period of time, e.g. due to direct sunlight on the AdBlue® tank, AdBlue® may start to decompose. Ammonia vapors develop as a result.

#### **⚠ Warning!**

When opening the filler cap of the AdBlue® tank ammonia gas vapors may escape. Refill AdBlue® in a well ventilated area only. Ammonia gas vapors have a pungent odor and are particularly irritating for your skin, mucous membranes, and eyes. Inhaling ammonia gas vapors will cause burning eyes, nose, and throat, as well as coughing and watering eyes.

### Low outside temperatures

AdBlue® freezes at a temperature of approximately 12 °F (11 °C). The vehicle is equipped with an AdBlue® preheating system at the factory. Winter operation can thus be guaranteed even at temperatures below 12 °F (-11 °C).

### Additives

**!** Use only AdBlue® complying with ISO 22241. Do not use any additives with AdBlue® and do not thin AdBlue® with water. This may destroy the BlueTEC exhaust gas aftertreatment system.

Damage resulting from the use of additives or water is not covered by the Mercedes-Benz Limited Warranty.

### Purity

Assuring the purity of AdBlue® is particularly important with respect to avoiding malfunctions in the exhaust gas aftertreatment system.

If AdBlue® is pumped out of the AdBlue® tank, e.g. during repair work, it must not be returned to the tank. The purity of the fluid can no longer be guaranteed.

**!** Impurities in AdBlue®, e.g. due to other service products, cleaning agents or dust, lead to increased emission values, system malfunctions, catalytic converter damage or damage to the BlueTEC system.

## Engine oil

### Points to remember

The engine oils are matched to the performance of Mercedes-Benz engines and service intervals. For this reason, only use engine oils and oil filters that are approved for vehicles with a service system.

Contact an authorized Mercedes-Benz Center or visit <http://www.mbusa.com> (USA only) for a list of approved engine oils and oil filters.

**!** Never use engine oil or an oil filter of a specification other than is necessary to fulfill the prescribed service intervals. Do not change the engine oil or oil filter in order to achieve longer replacement intervals than those prescribed. Otherwise, you may cause damage to the engine or exhaust gas aftertreatment; this is not covered by the Mercedes-Benz Limited Warranty.

Follow the instructions in the service interval display regarding the oil change. Otherwise, you may damage the engine and the exhaust gas aftertreatment.

Mercedes-Benz recommends MOBIL OIL.

The table shows which engines oil have been approved for your vehicle.

Model	Engine model	MB Approval
ML 350 BlueTEC 4MATIC	642	229.51
ML 350 4MATIC	272	229.5
ML 350	272	229.5
ML 550 4MATIC	273	229.5
ML 63 AMG	156	229.5 <sup>71</sup>

**i** MB Approval is stated on the containers.

### Lubricant additives

**!** Do not mix any lubricant additives with the engine oil. This could damage the engine. Damage resulting from the use of such lubricant additives in the engine oil is not covered by the Mercedes-Benz Limited Warranty.

### Engine oil viscosity

Viscosity describes the flow characteristics of a fluid. If an engine oil has a high viscosity, this means that it is thick; a low viscosity means that it is thin.

Using the table below, make sure that the SAE classification (viscosity) is sufficient for the temperatures at which the vehicle is operated. The low temperature characteristics of engine oils can deteriorate significantly, e.g. by aging, soot and fuel deposits. It is therefore recommended that you carry out oil changes regularly using an approved engine oil with the appropriate SAE classification.

<sup>71</sup> Restriction: only SAE 0W-40 or SAE 5W-40 engine oils may be used.

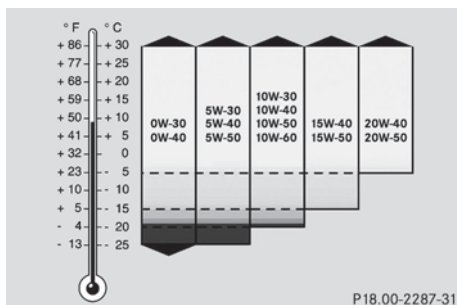

### Refrigerant of the air-conditioning system

The air-conditioning system is filled with R134a refrigerant and a special PAG lubricant.

**!** Never use refrigerant R 12 (CFC) or mineral lubricants. Otherwise, you could damage the air-conditioning system.

### Brake fluid

#### Warning!

The brake fluid constantly absorbs moisture from the air; this lowers its boiling point.

If the boiling point of the brake fluid is too low, vapor pockets may form in the brake system when the brakes are applied hard (e.g. when driving downhill). This would impair braking efficiency.

You should have the brake fluid renewed at regular intervals. The brake fluid change intervals can be found in the Service Booklet.

Only use brake fluid approved by Mercedes-Benz. Information about approved brake fluids can be obtained from any authorized Mercedes-Benz Center.

### Coolant

#### Important safety notes

The coolant is a mixture of water and antifreeze/corrosion inhibitor. It performs the following tasks:

- anti-corrosion protection
- antifreeze protection
- raising the boiling point

The cooling system is filled with coolant at the factory which contains antifreeze/corrosion inhibitor that ensures protection down to approximately -35 °F (-37 °C).

**!** Only add coolant that has been premixed with the desired antifreeze protection. You could otherwise damage the engine.

Further information on coolants and on filling can be found in the Mercedes-Benz Specifications for Service Products, MB Approval 310.1, e.g. on the Internet at <http://bevo.mercedes-benz.com>. You can also consult an authorized Mercedes-Benz Center.

**!** Always use a suitable coolant mixture, even in countries where high temperatures prevail.

Otherwise, the cooling system will not be sufficiently protected from corrosion, and the boiling point will be too low.

If the coolant has antifreeze protection down to -35 °F (-37 °C), the boiling point of the coolant in the pressurized system is approximately 266 °F (130 °C).

Your vehicle has a range of aluminum components. Use of aluminum components in the engine make it necessary to specifically match the antifreeze/corrosion inhibitor in these systems in order to protect the aluminum parts. Using other antifreeze/corrosion inhibitors without these characteristics affects the service life.

The coolant must be used throughout the year in order to maintain the necessary corrosion protection and provide protection from

overheating. In the Service Booklet, you can find information on the intervals for renewal.

The renewal interval is determined by the coolant type and the cooling system design. The renewal interval in the Service Booklet is only valid if the coolant is added or renewed with Mercedes-Benz approved products.

Therefore, only use MB 326.0 antifreeze/corrosion inhibitor or another Mercedes-Benz approved product of the same specification.

Information on other Mercedes-Benz approved products of the same specification can be obtained at any authorized Mercedes-Benz Center or on the Internet at

**http://bevo.mercedes-benz.com.**

The coolant is checked at every service date at an authorized Mercedes-Benz Center.

The antifreeze/corrosion inhibitor concentration in the cooling system should:

- be at least 50%. This will protect the cooling system against freezing down to around -35 °F (-37 °C).
- not exceed 55% (antifreeze protection down to -49 °F (-45 °C); otherwise, heat will not be dissipated as effectively.

If the coolant level is too low, MB 326.0 antifreeze/corrosion inhibitor should be added. Have the cooling system checked for leaks.

► Use MB Windshield Washer Concentrate MB SummerFit.

► **At temperatures above freezing:** add 1 part MB SummerFit to 100 parts water, e.g. 1.34 fl oz (40 ml) MB SummerFit to 1 gal (4.0 l) of water.

► **At temperatures below freezing:** add 1 part MB SummerFit to 100 parts washer fluid, e.g. 1.34 fl oz (40 ml) MB SummerFit to 1 gal (4.0 l) of water.

**Vehicle data**

**Vehicle data, ML 350 BlueTEC 4MATIC (164.125)**

The data quoted here refers specifically to a vehicle with standard equipment. Contact an authorized Mercedes-Benz Center for the data for all vehicle variants and trim levels.

**Vehicle dimensions, ML 350 BlueTEC 4MATIC**

<b>Vehicle length</b>	188.5 in (4788 mm)
<b>Vehicle width including exterior mirrors</b>	85.5 in (2170 mm)
<b>Vehicle height</b>	71.5 in (1815 mm) <sup>72</sup> 69.8 - 73.0 in (1774 - 1854 mm) <sup>73</sup>
<b>Wheelbase</b>	114.8 in (2915 mm)
<b>Front track</b>	63.7 in (1619 mm)
<b>Rear track</b>	63.8 in (1621 mm)
<b>Ground clearance</b>	8.3 in (210 mm) <sup>72</sup> 7.3 - 10.3 in (186 - 261 mm) <sup>73</sup>
<b>Turning circle</b>	38.1 ft (11.6 m)

**Windshield and headlamp cleaning system**

 **Warning**

Washer solvent/antifreeze is highly flammable. Do not spill washer solvent/antifreeze on hot engine parts, because it may ignite and burn. You could be seriously burned.

<sup>72</sup> Vehicles with steel-spring suspension.

<sup>73</sup> Vehicles with AIRMATIC package: the values vary depending on the level set for the vehicle suspension.

**Vehicle weight, ML 350 BlueTEC 4MATIC**

<b>Maximum roof load</b>	Maximum 220 lb (100 kg)
--------------------------	-------------------------

**Vehicle data, ML 350 (164.156)**

The data quoted here refers specifically to a vehicle with standard equipment. Contact an authorized Mercedes-Benz Center for the data for all vehicle variants and trim levels.

**i** This vehicle is only available in the USA.

**Vehicle dimensions, ML 350**

<b>Vehicle length</b>	188.5 in (4788 mm)
<b>Vehicle width including exterior mirrors</b>	85.5 in (2170 mm)
<b>Vehicle height</b>	71.5 in (1815 mm)
<b>Wheelbase</b>	114.8 in (2915 mm)
<b>Front track</b>	64.0 in (1627 mm)
<b>Rear track</b>	64.1 in (1629 mm)
<b>Ground clearance</b>	8.3 in (210 mm)
<b>Turning circle</b>	38.1 ft (11.6 m)

**Vehicle weight, ML 350**

<b>Maximum roof load</b>	Maximum 220 lb (100 kg)
--------------------------	-------------------------

**Vehicle data, ML 350 4MATIC (164.186)**

The data quoted here refers specifically to a vehicle with standard equipment. Contact an authorized Mercedes-Benz Center for the data for all vehicle variants and trim levels.

<sup>74</sup> Vehicles with steel-spring suspension.

<sup>75</sup> Vehicles with AIRMATIC package: the values vary depending on the level set for the vehicle suspension.

<sup>76</sup> Steel-sprung vehicles.

**Vehicle dimensions, ML 350 4MATIC**

<b>Vehicle length</b>	188.5 in (4788 mm)
<b>Vehicle width including exterior mirrors</b>	85.5 in (2170 mm)
<b>Vehicle height</b>	71.5 in (1815 mm) <sup>74</sup> 69.8 - 73.0 in (1774 - 1854 mm) <sup>75</sup>
<b>Wheelbase</b>	114.8 in (2915 mm)
<b>Front track</b>	64.0 in (1627 mm)
<b>Rear track</b>	64.1 in (1629 mm)
<b>Ground clearance</b>	8.3 in (210 mm) <sup>74</sup> 7.3 - 10.3 in (186 - 261 mm) <sup>75</sup>
<b>Turning circle</b>	38.1 ft (11.6 m)

**Vehicle weight, ML 350 4MATIC**

<b>Maximum roof load</b>	Maximum 220 lb (100 kg)
--------------------------	-------------------------

**Vehicle data, ML 550 4MATIC (164.172)**

The data quoted here refers specifically to a vehicle with standard equipment. Contact an authorized Mercedes-Benz Center for the data for all vehicle variants and trim levels.

**Vehicle dimensions, ML 550 4MATIC**

<b>Vehicle length</b>	188.5 in (4788 mm)
<b>Vehicle width including exterior mirrors</b>	85.5 in (2170 mm)
<b>Vehicle height</b>	71.5 in (1815 mm) <sup>76</sup>

**Vehicle dimensions, ML 550 4MATIC**

	69.8 - 73.0 in (1774 - 1854 mm) <sup>77</sup>
<b>Wheel base</b>	114.8 in (2915 mm)
<b>Front track</b>	63.7 in (1619 mm)
<b>Rear track</b>	63.8 in (1621 mm)
<b>Ground clearance</b>	8.3 in (210 mm) <sup>76</sup>
	7.3 - 10.3 in (186 - 261 mm) <sup>77</sup>
<b>Turning circle</b>	38.1 ft (11.6 m)

**Vehicle weight, ML 550 4MATIC**

<b>Maximum roof load</b>	Maximum 220 lb (100 kg)
--------------------------	-------------------------

**Vehicle data, ML 63 AMG (164.177)**

The data quoted here refers specifically to a vehicle with standard equipment. Contact an authorized Mercedes-Benz Center for the data for all vehicle variants and trim levels.

**Vehicle dimensions, ML 63 AMG**

<b>Vehicle length</b>	189.7 in (4818 mm)
<b>Vehicle width including exterior mirrors</b>	85.5 in (2170 mm)
<b>Vehicle height</b>	69.5 - 72.6 in (1765 - 1845 mm) <sup>78</sup>
<b>Wheelbase</b>	114.8 in (2915 mm)
<b>Front track</b>	65.5 in (1664 mm)
<b>Rear track</b>	65.6 in (1667 mm)

**Vehicle dimensions, ML 63 AMG**

<b>Ground clearance</b>	7.0 - 10.1 in (177 - 257 mm) <sup>78</sup>
<b>Turning circle</b>	38.1 ft (11.6 m)

**Vehicle weight, ML 63 AMG**

<b>Maximum roof load</b>	Maximum 220 lb (100 kg)
--------------------------	-------------------------

<sup>77</sup> On vehicles with the AIRMATIC package, the values vary depending on the level of the vehicle.

<sup>76</sup> Steel-sprung vehicles.

<sup>78</sup> The values vary depending on the level set for the vehicle suspension.







## **Publication details**

### **Internet**

Further information about Mercedes-Benz vehicles and about Daimler AG can be found on the following websites:

<http://www.mbusa.com> (USA only)

<http://www.mercedes-benz.ca> (Canada only)

### **Editorial office**

Not to be reprinted, translated or otherwise reproduced, in whole or in part, without the written permission of Daimler AG.

As at 27.01.2010



1645843783

Order no. 6515 4337 13 Part no. 164 584 37 83 Edition B 2011