

	Pictorial index	Search by illustration	
1	For safety and security	Make sure to read through them	
2	Instrument cluster	How to read the gauges and meters, the variety of warning lights and indicators, etc.	
3	Operation of each component	Opening and closing the doors and windows, adjustment before driving, etc.	
4	Driving	Operations and advice which are necessary for driving	
5	Interior features	Usage of the interior features, etc.	
6	Maintenance and care	Caring for your vehicle and maintenance procedures	
7	When trouble arises	What to do in case of malfunction or emergency	
8	Vehicle specifications	Vehicle specifications, customizable features, etc.	
9	For U.S. owners	Reporting safety defects for U.S. owners	
	Index	Search by symptom	
		Search alphabetically	

For your information.....	8
Reading this manual.....	12
How to search.....	13
Pictorial index	14

1 For safety and security

1-1. For safe use

Before driving	26
For safety drive	28
Seat belts	30
SRS airbags	38
Front passenger occupant classification system	51
Safety information for children	57
Child restraint systems.....	58
Installing child restraints.....	63
Exhaust gas precautions.....	73

1-2. Theft deterrent system

Engine immobilizer system.....	74
Alarm.....	76

2 Instrument cluster

2. Instrument cluster

Warning and indicators lights.....	80
Gauges and meters.....	85
Multi-information display	89
Fuel consumption information	98

3 Operation of each component

3-1. Key information

Keys.....	102
-----------	-----

3-2. Opening, closing and locking the doors

Side doors	106
Back door	114
Smart key system	120

3-3. Adjusting the seats

Front seats.....	127
Rear seats	129
Driving position memory	136
Head restraints	140

3-4. Adjusting the steering wheel and mirrors

Steering wheel.....	143
Inside rear view mirror	145
Outside rear view mirrors	147

3-5. Opening, closing the windows and moon roof

Power windows.....	150
Moon roof	154

4 Driving

4-1. Before driving

Driving the vehicle.....	160
Cargo and luggage.....	169
Vehicle load limits	175
Trailer towing.....	176
Dinghy towing.....	192

4-2. Driving procedures

Engine (ignition) switch	193
Automatic transmission	199
Turn signal lever.....	203
Parking brake	204

4-3. Operating the lights and wipers

Headlight switch	205
Automatic High Beam	209
Fog light switch	214
Windshield wipers and washer	215
Rear window wiper and washer	219
Headlight cleaner switch	221

4-4. Refueling

Opening the fuel tank cap	222
---------------------------------	-----

4-5. Using the driving support systems

Toyota Safety Sense P.....	226
PCS (Pre-Collision System).....	233
LDA (Lane Departure Alert).....	248
Dynamic radar cruise control.....	257
Cruise control	269
Intuitive parking assist	272
Four-wheel drive system ...	280
Crawl Control (with Turn Assist function)	284
Multi-terrain Select.....	289
Multi-terrain Monitor.....	293
BSM (Blind Spot Monitor).....	343
• BSM function	347
• RCTA function	351
Driving assist systems	357

4-6. Driving tips

Off-road precautions.....	364
Winter driving tips	369

5 Interior features

5-1. Using the air conditioning system and defogger

Front automatic air conditioning system	374
Rear air conditioning system.....	385
Heated steering wheel/seat heaters/seat ventilators ...	389

5-2. Using the interior lights

Interior lights list	393
• Interior lights	394
• Personal lights	395

5-3. Using the storage features

List of storage features.....	396
• Glove box.....	397
• Console box.....	398
• Overhead console.....	399
• Cup holders	400
• Bottle holders.....	402
• Card holders	403
• Auxiliary boxes.....	403
Luggage compartment features	404

5-4. Using the other interior features

Other interior features.....	406
• Cool box	406
• Sun visors	408
• Vanity mirror	408
• Clock	409
• Outside temperature display	409
• Power outlets	410
• Wireless charger	412
• Armrest.....	420
• Coat hooks	420
• Assist grips	421
Garage door opener	422
Safety Connect	427

6 Maintenance and care

- 6-1. Maintenance and care**
- Cleaning and protecting the vehicle exterior..... 434
 - Cleaning and protecting the vehicle interior..... 437
- 6-2. Maintenance**
- Maintenance requirements..... 440
 - General maintenance..... 443
 - Emission inspection and maintenance (I/M) programs..... 446
- 6-3. Do-it-yourself maintenance**
- Do-it-yourself service precautions 447
 - Hood..... 449
 - Engine compartment..... 450
 - Tires 463
 - Tire inflation pressure..... 472
 - Wheels 475
 - Air conditioning filter..... 477
 - Electronic key battery..... 479
 - Checking and replacing fuses 481
 - Headlight aim 485
 - Light bulbs..... 487

7 When trouble arises

- 7-1. Essential information**
- Emergency flashers..... 500
 - If your vehicle has to be stopped in an emergency..... 501
- 7-2. Steps to take in an emergency**
- If your vehicle needs to be towed..... 502
 - If you think something is wrong..... 508
 - Fuel pump shut off system 509
 - If a warning light turns on or a warning buzzer sounds..... 510
 - If a warning message is displayed 519
 - If you have a flat tire 524
 - If the engine will not start... 537
 - If the shift lever cannot be shifted from P 539
 - If the electronic key does not operate properly 540
 - If the vehicle battery is discharged..... 543
 - If your vehicle overheats.... 546
 - If the vehicle becomes stuck 549

8 Vehicle specifications**8-1. Specifications**

Maintenance data (fuel, oil level, etc.)	552
Fuel information	560
Tire information	563

8-2. Customization

Customizable features	574
-----------------------------	-----

8-3. Initialization

Items to initialize.....	584
--------------------------	-----

9 For U.S. owners

Reporting safety defects for U.S. owners.....	586
--	-----

Index

What to do if... (Troubleshooting)	588
Alphabetical index.....	592

For vehicles with a navigation system or a multimedia system, refer to the “NAVIGATION SYSTEM OWNER’S MANUAL” for information regarding the equipment listed below.

- Navigation system
- Audio/video system
- Rear seat entertainment system
- Hands-free system (for cellular phone)



For your information

Main Owner's Manual

Please note that this manual applies to all models and explains all equipment, including options. Therefore, you may find some explanations for equipment not installed on your vehicle.

All specifications provided in this manual are current at the time of printing. However, because of the Toyota policy of continual product improvement, we reserve the right to make changes at any time without notice.

Depending on specifications, the vehicle shown in the illustrations may differ from your vehicle in terms of color and equipment.

Noise from under vehicle after turning off the engine

Approximately five hours after the engine is turned off, you may hear sound coming from under the vehicle for several minutes. This is the sound of a fuel evaporation leakage check and, it does not indicate a malfunction.

Accessories, spare parts and modification of your Toyota

A wide variety of non-genuine spare parts and accessories for Toyota vehicles are currently available in the market. You should know that Toyota does not warrant these products and is not responsible for their performance, repair, or replacement, or for any damage they may cause to, or adverse effect they may have on, your Toyota vehicle.

This vehicle should not be modified with non-genuine Toyota products. Modification with non-genuine Toyota products could affect its performance, safety or durability, and may even violate governmental regulations. In addition, damage or performance problems resulting from the modification may not be covered under warranty.

Installation of a mobile two-way radio system

The installation of a mobile two-way radio system in your vehicle could affect electronic systems such as:

- Multiport fuel injection system/sequential multiport fuel injection system
- Dynamic radar cruise control system
- Cruise control system
- Anti-lock brake system
- SRS airbag system
- Seat belt pretensioner system

Be sure to check with your Toyota dealer for precautionary measures or special instructions regarding installation of a mobile two-way radio system.

Vehicle data recordings

Your Toyota is equipped with several sophisticated computers that will record certain data, such as:

- Engine speed
- Accelerator status
- Brake status
- Vehicle speed
- Shift position

The recorded data varies according to the vehicle grade level and options with which it is equipped. Furthermore, these computers do not record conversations, sounds or pictures.

● Data usage

Toyota may use the data recorded in these computers to diagnose malfunctions, conduct research and development, and improve quality.

Toyota will not disclose the recorded data to a third party except:

- With the consent of the vehicle owner or with the consent of the lessee if the vehicle is leased
- In response to an official request by the police, a court of law or a government agency
- For use by Toyota in a lawsuit
- For research purposes where the data is not tied to a specific vehicle or vehicle owner

● Usage of data collected through Safety Connect (U.S. mainland only)

If your Toyota has Safety Connect and if you have subscribed to those services, please refer to the Safety Connect Telematics Subscription Service Agreement for information on data collected and its usage.

Event data recorder

This vehicle is equipped with an event data recorder (EDR). The main purpose of an EDR is to record, in certain crash or near crash-like situations, such as an air bag deployment or hitting a road obstacle, data that will assist in understanding how a vehicle's systems performed. The EDR is designed to record data related to vehicle dynamics and safety systems for a short period of time, typically 30 seconds or less.

The EDR in this vehicle is designed to record such data as:

- How various systems in your vehicle were operating;
- Whether or not the driver and passenger safety belts were buckled/fastened;
- How far (if at all) the driver was depressing the accelerator and/or brake pedal; and,
- How fast the vehicle was traveling.

These data can help provide a better understanding of the circumstances in which crashes and injuries occur.

NOTE: EDR data are recorded by your vehicle only if a nontrivial crash situation occurs; no data are recorded by the EDR under normal driving conditions and no personal data (e.g., name, gender, age, and crash location) are recorded. However, other parties, such as law enforcement, could combine the EDR data with the type of personally identifying data routinely acquired during a crash investigation.

To read data recorded by an EDR, special equipment is required, and access to the vehicle or the EDR is needed. In addition to the vehicle manufacturer, other parties, such as law enforcement, that have the special equipment, can read the information if they have access to the vehicle or the EDR.

● Disclosure of the EDR data

Toyota will not disclose the data recorded in an EDR to a third party except when:

- An agreement from the vehicle's owner (or the lessee for a leased vehicle) is obtained
- In response to an official request by the police, a court of law or a government agency
- For use by Toyota in a lawsuit

However, if necessary, Toyota may:

- Use the data for research on vehicle safety performance
- Disclose the data to a third party for research purposes without disclosing information about the specific vehicle or vehicle owner

Scrapping of your Toyota

The SRS airbag and seat belt pretensioner devices in your Toyota contain explosive chemicals. If the vehicle is scrapped with the airbags and seat belt pretensioners left as they are, this may cause an accident such as fire. Be sure to have the systems of the SRS airbag and seat belt pretensioner removed and disposed of by a qualified service shop or by your Toyota dealer before you scrap your vehicle.

Perchlorate Material

Special handling may apply,
See www.dtsc.ca.gov/hazardouswaste/perchlorate.
Your vehicle has components that may contain perchlorate. These components may include airbag, seat belt pretensioners, and wireless remote control batteries.

WARNING

■ General precautions while driving

Driving under the influence: Never drive your vehicle when under the influence of alcohol or drugs that have impaired your ability to operate your vehicle. Alcohol and certain drugs delay reaction time, impair judgment and reduce coordination, which could lead to an accident that could result in death or serious injury.

Defensive driving: Always drive defensively. Anticipate mistakes that other drivers or pedestrians might make and be ready to avoid accidents.

Driver distraction: Always give your full attention to driving. Anything that distracts the driver, such as adjusting controls, talking on a cellular phone or reading can result in a collision with resulting death or serious injury to you, your occupants or others.

■ General precaution regarding children's safety

Never leave children unattended in the vehicle, and never allow children to have or use the key.

Children may be able to start the vehicle or shift the vehicle into neutral. There is also a danger that children may injure themselves by playing with the windows, the moon roof, or other features of the vehicle. In addition, heat build-up or extremely cold temperatures inside the vehicle can be fatal to children.

Reading this manual



WARNING:

Explains something that, if not obeyed, could cause death or serious injury to people.



NOTICE:

Explains something that, if not obeyed, could cause damage to or a malfunction in the vehicle or its equipment.



Indicates operating or working procedures. Follow the steps in numerical order.



Indicates the action (pushing, turning, etc.) used to operate switches and other devices.



Indicates the outcome of an operation (e.g. a lid opens).

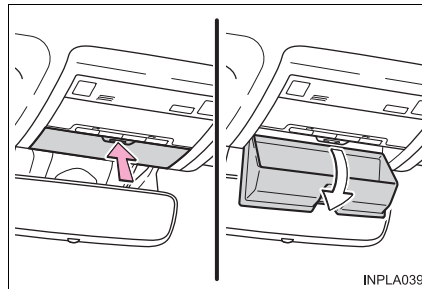

Indicates the component or position being explained.



Means “Do not”, “Do not do this”, or “Do not let this happen”.

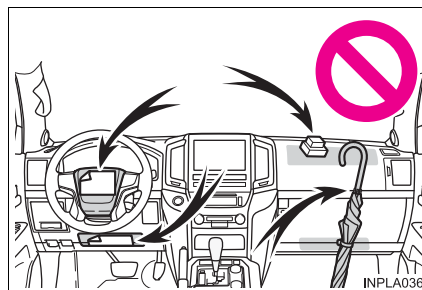

How to search

■ Searching by name

- Alphabetical index.....P. 592

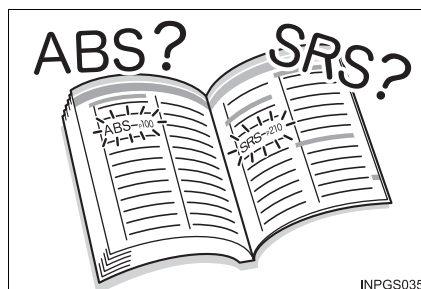

■ Searching by installation position

- Pictorial index.....P. 14

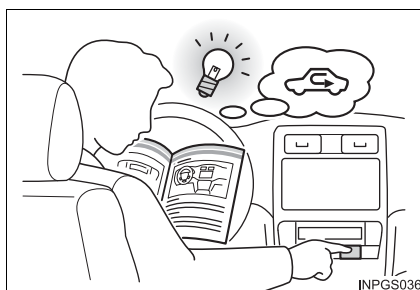

■ Searching by symptom or sound

- What to do if...
(Troubleshooting).....P. 588



■ Searching by title

- Table of contents.....P. 2

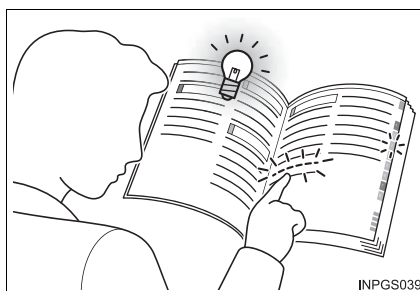

Pictorial index

■ Exterior

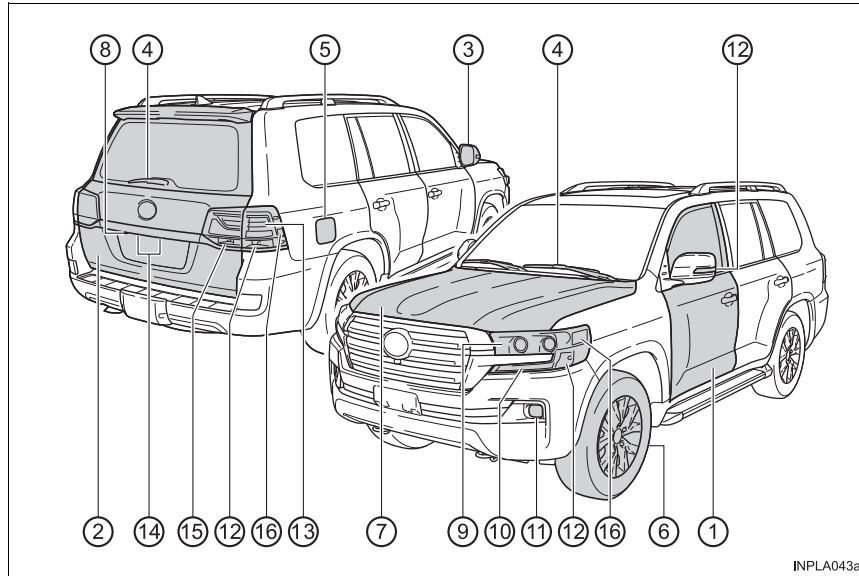

INPLA043a

- ① **Side doors** **P. 106**
 - Locking/unlocking P. 106
 - Opening/closing the door glasses P. 150
 - Locking/unlocking by using the mechanical key P. 540
 - Warning lights/warning messages P. 512, 519
- ② **Back door** **P. 114**
 - Opening from outside P. 115
 - Warning lights/warning messages P. 512, 519
- ③ **Outside rear view mirrors** **P. 147**
 - Adjusting the mirror angle P. 147
 - Folding the mirrors P. 147
 - Driving position memory P. 136
 - Defogging the mirrors P. 380

④	Windshield wipers	P. 215
	Rear window wiper	P. 219
	Precautions against winter season	P. 369
	To prevent freezing (windshield wiper de-icer [*]).	P. 380
	Precautions against car wash	P. 435
⑤	Fuel filler door	P. 222
	Refueling method.	P. 222
	Fuel type/fuel tank capacity	P. 554
⑥	Tires	P. 463
	Tire size/inflation pressure	P. 558
	Winter tires/tire chain	P. 369
	Checking/rotation/tire pressure warning system	P. 463
	Coping with flat tires	P. 524
⑦	Hood	P. 449
	Opening	P. 449
	Engine oil.	P. 554
	Coping with overheat.	P. 546
⑧	Camera[*]	P. 293

Light bulbs of the exterior lights for driving

(Replacing method: P. 487, Watts: P. 552)

⑨	Headlights/daytime running lights	P. 205
⑩	Parking lights	P. 205
⑪	Fog lights	P. 214
⑫	Turn signal lights	P. 203
⑬	Stop/tail lights	
	Hill-start assist control	P. 357
⑭	License plate lights	P. 205
⑮	Back-up lights	
	Shifting the shift lever to R.	P. 199
⑯	Side marker lights	P. 205

^{*}: If equipped

Instrument panel

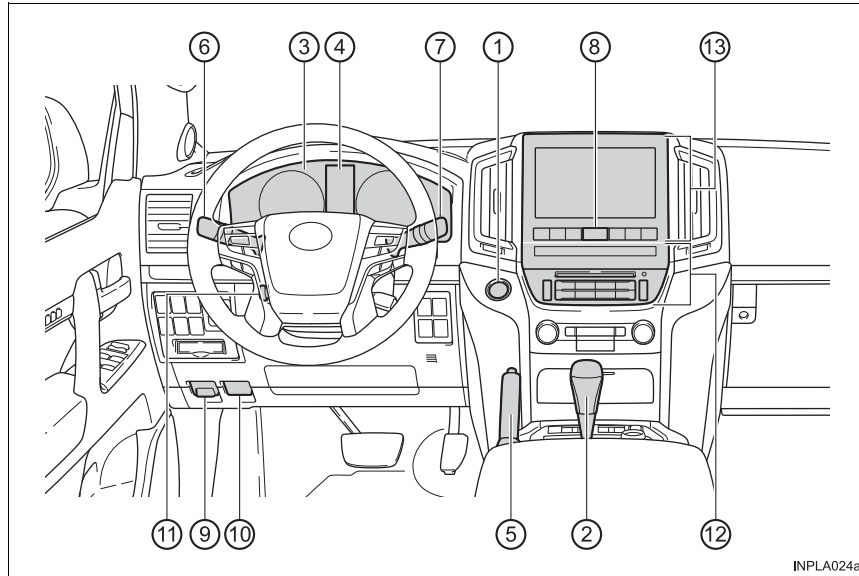

INPLA024a

- ① **Engine switch** **P. 193**
 Starting the engine/changing the modes P. 193
 Emergency stop of the engine P. 501
 When the engine will not start P. 537
 Warning messages P. 519
- ② **Shift lever** **P. 199**
 Changing the shift position. P. 199
 Precautions against towing P. 502
 When the shift lever does not move. P. 539
- ③ **Meters** **P. 85**
 Reading the meters/adjusting the instrument panel light. P. 85
 Warning lights/indicators P. 80
 When the warning lights come on P. 510

- ④ **Multi-information display** **P. 89**
 - Display P. 89
 - When the warning messages are displayed P. 519
- ⑤ **Parking brake** **P. 204**
 - Applying/releasing P. 204
 - Precautions against winter season P. 370
 - Warning buzzer/message P. 204, 519
- ⑥ **Turn signal lever** **P. 203**
 - Headlight switch** **P. 205**
 - Headlights/parking lights/tail lights/daytime running lights P. 205
 - Fog lights P. 214
- ⑦ **Windshield wiper and washer switch** **P. 215**
 - Rear window wiper and washer switch** **P. 219**
 - Usage P. 215, 219
 - Adding washer fluid P. 462
- ⑧ **Emergency flasher switch** **P. 500**
- ⑨ **Fuel filler door opener** **P. 224**
- ⑩ **Hood lock release lever** **P. 449**
- ⑪ **Tilt and telescopic steering control switch** **P. 143**
 - Adjustment P. 143
 - Driving position memory P. 136
- ⑫ **Air conditioning system** **P. 374**
 - Usage P. 374
 - Rear window defogger P. 380
- ⑬ **Audio system***
 - Navigation system***

*: Refer to "NAVIGATION SYSTEM OWNER'S MANUAL".

■ **Switches**

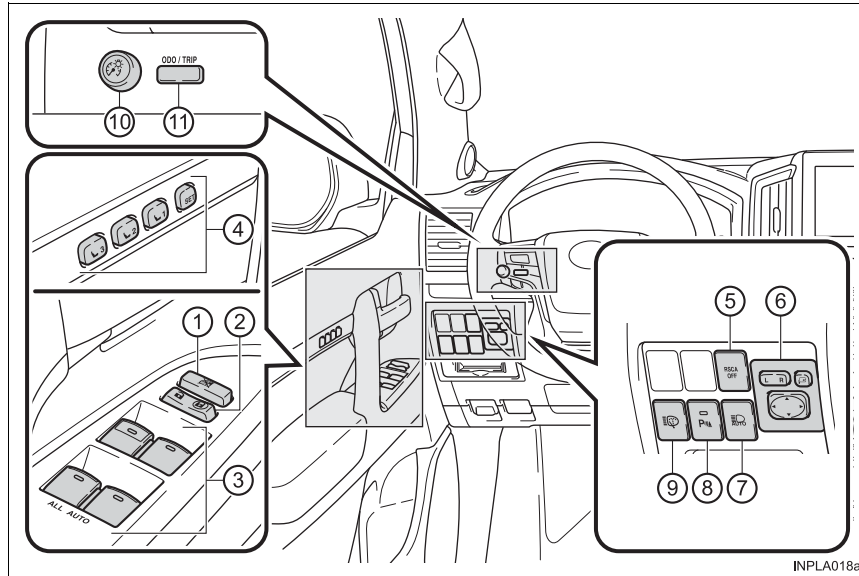

INPLA018a

- ① **Window lock switch** **P. 150**
- ② **Door lock switches** **P. 108**
- ③ **Power window switches** **P. 150**
- ④ **Driving position memory buttons** **P. 136**
- ⑤ **“RSCA OFF” switch** **P. 50**
- ⑥ **Outside rear view mirror switches** **P. 147**
- ⑦ **Automatic High Beam switch** **P. 209**
- ⑧ **Intuitive parking assist switch** **P. 272**
- ⑨ **Headlight cleaner switch*** **P. 221**
- ⑩ **Instrument cluster light control dial** **P. 86**
- ⑪ **Odometer/trip meter and trip meter reset button** **P. 86**

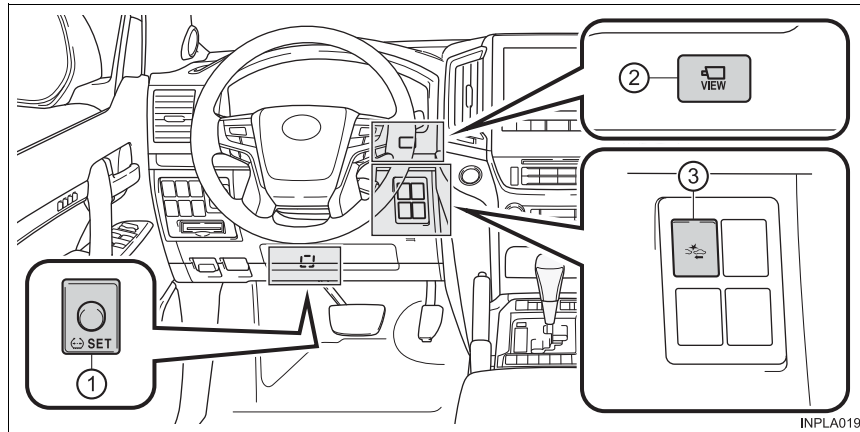

- ① Tire pressure warning reset switch* P. 464
- ② VIEW switch* P. 293
- ③ PCS (Pre-Collision System) switch* P. 233

*: If equipped

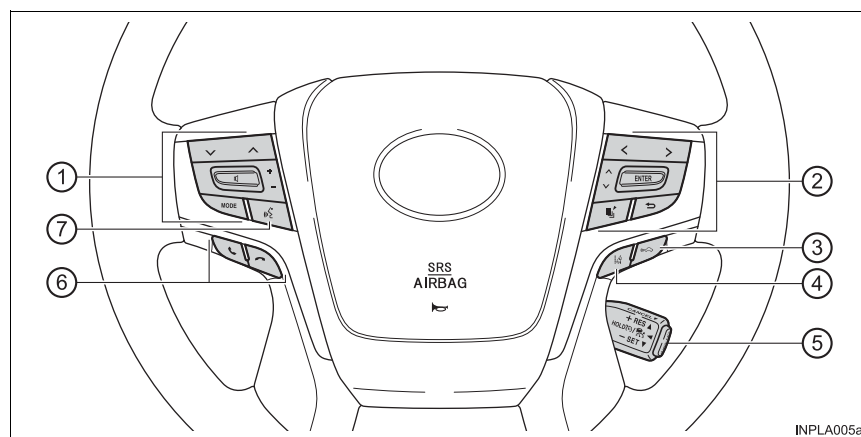

INPLA005a

- ① **Audio remote control switches**^{*1}
- ② **Meter control switches**^{*1} P. 91
- ③ **Vehicle-to-vehicle distance button**^{*2} P. 257
- ④ **LDA (Lane Departure Alert) switch**^{*2} P. 248
- ⑤ **Cruise control switch**
 Cruise control^{*2} P. 269
 Dynamic radar cruise control^{*2} P. 257
- ⑥ **Telephone switches**^{*1}
- ⑦ **Talk switch**^{*1}

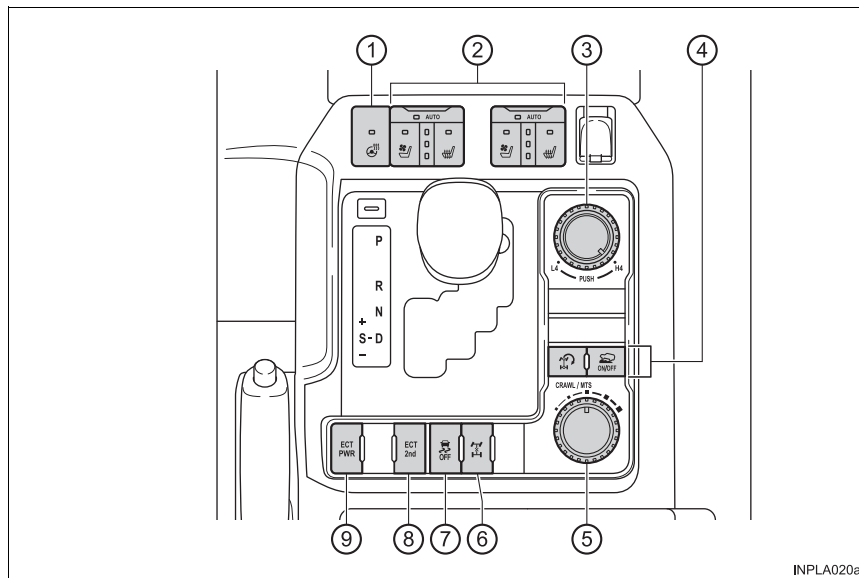

INPLA020a

- ① Heated steering wheel switch *2 P. 389
- ② Front seat heater/ventilator switches* P. 389
- ③ Four-wheel drive control switch..... P. 280
- ④ Crawl Control switch..... P. 284
- ⑤ Multi-terrain Select mode selector dial P. 289
- ⑥ Center differential lock/unlock switch *2 P. 281
- ⑦ VSC OFF switch P. 359
- ⑧ Second start mode switch P. 199
- ⑨ Power mode switch P. 199

*1: Refer to "NAVIGATION SYSTEM OWNER'S MANUAL".

*2: If equipped

Interior

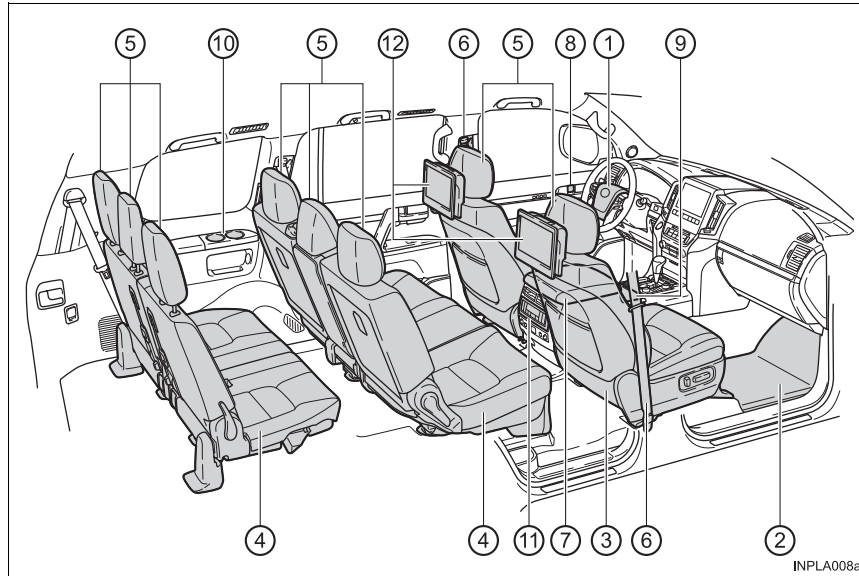

- ① SRS airbags P. 38
- ② Floor mats P. 26
- ③ Front seats P. 127
- ④ Rear seats P. 129
- ⑤ Head restraints P. 140
- ⑥ Seat belts P. 30
- ⑦ Console box P. 398
Cool box*1 P. 406
- ⑧ Inside lock buttons P. 108
- ⑨ Cup holders P. 396
- ⑩ Bottle holders P. 396
- ⑪ Rear air conditioning system P. 385
- ⑫ Rear seat entertainment system*1, 2

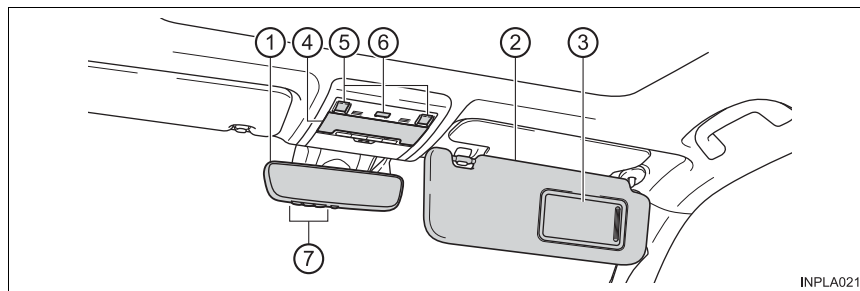

INPLA021

①	Inside rear view mirror	P. 145
②	Sun visors	P. 408
③	Vanity mirror.....	P. 408
④	Personal/interior lights ^{*3}	P. 393
⑤	Moon roof switches	P. 154
⑥	“SOS” button ^{*1}	P. 427
⑦	Garage door opener buttons	P. 422

^{*1}: If equipped

^{*2}: Refer to “NAVIGATION SYSTEM OWNER’S MANUAL”.

^{*3}: The illustration shows the front, but they are also equipped in the rear.

For safety and security

1

25

1-1. For safe use

Before driving..... 26
For safety drive 28
Seat belts 30
SRS airbags..... 38
Front passenger occupant
classification system 51
Safety information for
children 57
Child restraint systems..... 58
Installing child restraints..... 63
Exhaust gas precautions..... 73

1-2. Theft deterrent system

Engine immobilizer
system 74
Alarm..... 76

Before driving

Floor mat

Use only floor mats designed specifically for vehicles of the same model and model year as your vehicle. Fix them securely in place onto the carpet.

- 1 Insert the retaining hooks (clips) into the floor mat eyelets.

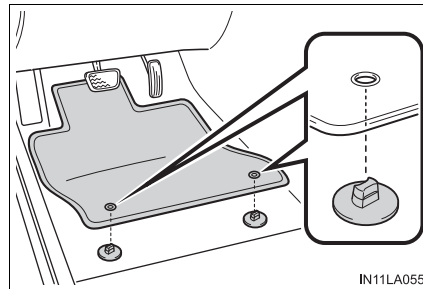

- 2 Turn the upper knob of each retaining hook (clip) to secure the floor mats in place.

*: Always align the \triangle marks.

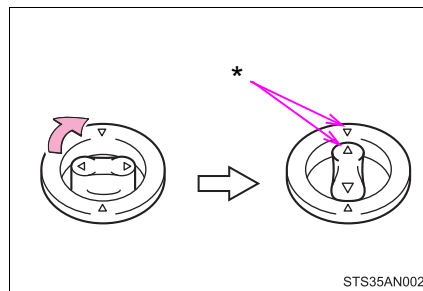

The shape of the retaining hooks (clips) may differ from that shown in the illustration.

⚠ WARNING

Observe the following precautions.

Failure to do so may cause the driver's floor mat to slip, possibly interfering with the pedals while driving. An unexpectedly high speed may result or it may become difficult to stop the vehicle. This could lead to an accident, resulting in death or serious injury.

■ When installing the driver's floor mat

- Do not use floor mats designed for other models or different model year vehicles, even if they are Toyota Genuine floor mats.
- Only use floor mats designed for the driver's seat.
- Always install the floor mat securely using the retaining hooks (clips) provided.
- Do not use two or more floor mats on top of each other.
- Do not place the floor mat bottom-side up or upside-down.

■ Before driving

- Check that the floor mat is securely fixed in the correct place with all the provided retaining hooks (clips). Be especially careful to perform this check after cleaning the floor.
- With the engine stopped and the shift lever in P, fully depress each pedal to the floor to make sure it does not interfere with the floor mat.

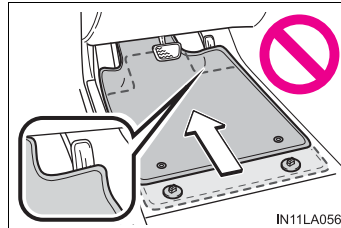

For safety drive

For safe driving, adjust the seat and mirror to an appropriate position before driving.

Correct driving posture

- ① Adjust the angle of the seat-back so that you are sitting straight up and so that you do not have to lean forward to steer. (→P. 127)
- ② Adjust the seat so that you can depress the pedals fully and so that your arms bend slightly at the elbow when gripping the steering wheel. (→P. 127)
- ③ Lock the head restraint in place with the center of the head restraint closest to the top of your ears. (→P. 140)
- ④ Wear the seat belt correctly. (→P. 30)

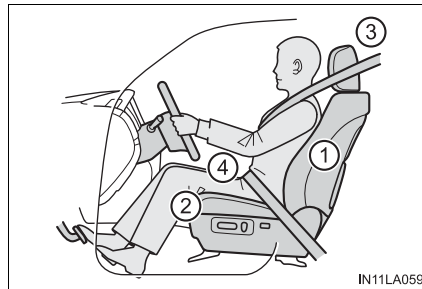

Correct use of the seat belts

Make sure that all occupants are wearing their seat belts before driving the vehicle. (→P. 30)

Use a child restraint system appropriate for the child until the child becomes large enough to properly wear the vehicle's seat belt. (→P. 58)

Adjusting the mirrors

Make sure that you can see backward clearly by adjusting the inside and outside rear view mirrors properly. (→P. 145, 147)

WARNING

Observe the following precautions.

Failure to do so may result in death or serious injury.

- Do not adjust the position of the driver's seat while driving.
Doing so could cause the driver to lose control of the vehicle.
- Do not place a cushion between the driver or passenger and the seatback.
A cushion may prevent correct posture from being achieved, and reduce the effectiveness of the seat belt and head restraint.
- Do not place anything under the front seats.
Objects placed under the front seats may become jammed in the seat tracks and stop the seat from locking in place. This may lead to an accident and the adjustment mechanism may also be damaged.
- When driving over long distances, take regular breaks before you start to feel tired.
Also, if you feel tired or sleepy while driving, do not force yourself to continue driving and take a break immediately.

Seat belts

Make sure that all occupants are wearing their seat belts before driving the vehicle.

Correct use of the seat belts

- Extend the shoulder belt so that it comes fully over the shoulder, but does not come into contact with the neck or slide off the shoulder.
- Position the lap belt as low as possible over the hips.
- Adjust the position of the seat-back. Sit up straight and well back in the seat.
- Do not twist the seat belt.

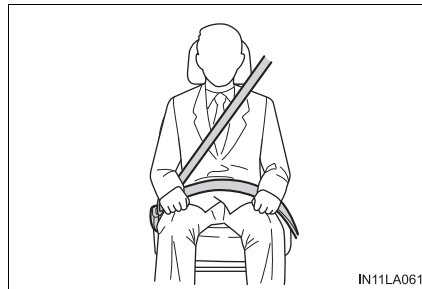

Fastening and releasing the seat belt (except for the third center seat)

- ① To fasten the seat belt, push the plate into the buckle until a click sound is heard.
- ② To release the seat belt, press the release button.

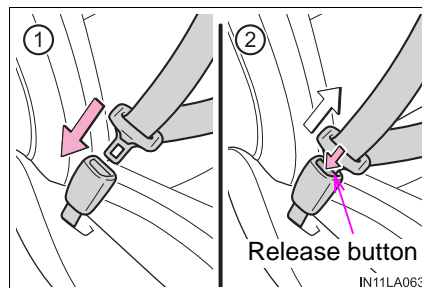

Fastening and releasing the third center seat belt

- 1 Pull out the tab.

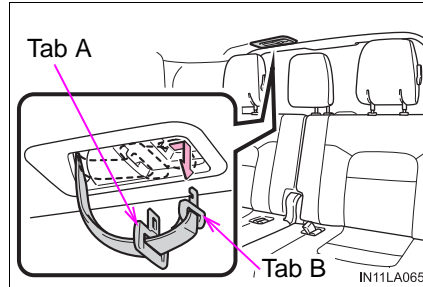

- 2 Push tab B into buckle B until a clicking sound is heard.

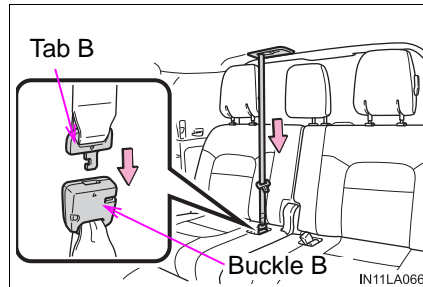

- 3 Push tab A into buckle A until a clicking sound is heard.
To release, push the release button on buckle A.

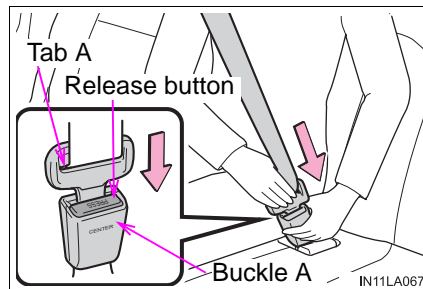

Releasing and storing the third center seat belt

- 1 Push the release button on buckle A.

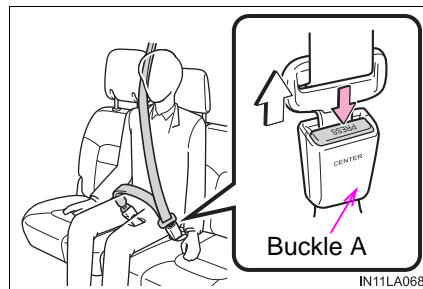

- 2 Push either the mechanical key or tab A into buckle B.

When releasing and storing the seat belt, hold the belt while winding it back gently.

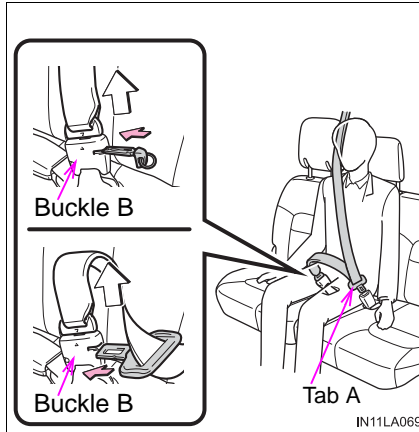

- 3 Put tabs A and B together and stow them in the holder.

To reattach the seat belt, reverse the above procedure, pulling out the tabs and inserting tab B into buckle B.

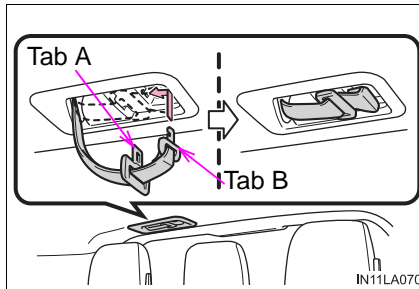

Adjusting the seat belt shoulder anchor height (front and second outboard seats)

- ① Push the seat belt shoulder anchor down while pressing the release button.
- ② Push the seat belt shoulder anchor up.

Move the height adjuster up and down as needed until you hear a click.

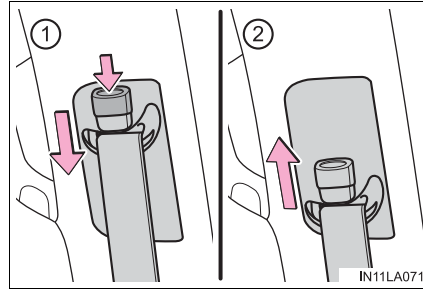

Seat belt pretensioners (front and second outboard seats)

The pretensioners help the seat belts to quickly restrain the occupants by retracting the seat belts when the vehicle is subjected to certain types of severe frontal collision or a vehicle rollover.

The pretensioners do not activate in the event of a minor frontal impact, a side impact or a rear impact.

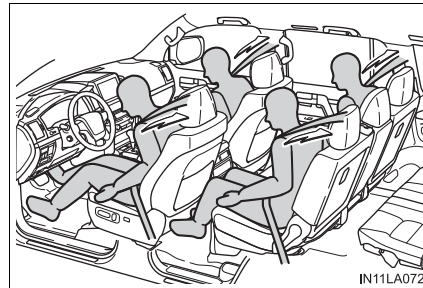

■ Emergency locking retractor (ELR)

The retractor will lock the belt during a sudden stop or on impact. It may also lock if you lean forward too quickly. A slow, easy motion will allow the belt to extend so that you can move around fully.

■ Automatic locking retractor (ALR)

When a passenger's shoulder belt is completely extended and then retracted even slightly, the belt is locked in that position and cannot be extended. This feature is used to hold the child restraint system (CRS) firmly. To free the belt again, fully retract the belt and then pull the belt out once more. (→P. 63)

■ When the third center seat belt cannot be extended

Put your fingers between the seat belt and the holder.

Pull the seat belt forcefully in the direction of the arrow and then release it to unlock.

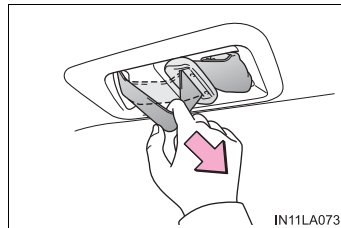

■ Child seat belt usage

The seat belts of your vehicle were principally designed for persons of adult size.

- Use a child restraint system appropriate for the child, until the child becomes large enough to properly wear the vehicle's seat belt. (→P. 58)
- When the child becomes large enough to properly wear the vehicle's seat belt, follow the instructions on P. 30 regarding seat belt usage.

■ Replacing the belt after the pretensioner has been activated

If the vehicle is involved in multiple collisions, the pretensioner will activate for the first collision, but will not activate for the second or subsequent collisions.

■ Seat belt extender

If your seat belts cannot be fastened securely because they are not long enough, a personalized seat belt extender is available from your Toyota dealer free of charge.

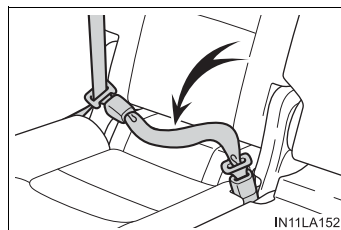

⚠ WARNING

Observe the following precautions to reduce the risk of injury in the event of sudden braking, sudden swerving or an accident. Failure to do so may cause death or serious injury.

■ Wearing a seat belt

- Ensure that all passengers wear a seat belt.
- Always wear a seat belt properly.
- Each seat belt should be used by one person only. Do not use a seat belt for more than one person at once, including children.
- Toyota recommends that children be seated in the rear seat and always use a seat belt and/or an appropriate child restraint system.
- To achieve a proper seating position, do not recline the seat more than necessary. The seat belt is most effective when the occupants are sitting up straight and well back in the seats.
- Do not wear the shoulder belt under your arm.
- Always wear your seat belt low and snug across your hips.

■ Pregnant women

Obtain medical advice and wear the seat belt in the proper way. (→P. 30)

Women who are pregnant should position the lap belt as low as possible over the hips in the same manner as other occupants, extending the shoulder belt completely over the shoulder and avoiding belt contact with the rounding of the abdominal area.

If the seat belt is not worn properly, not only the pregnant woman, but also the fetus could suffer death or serious injury as a result of sudden braking, sudden swerving or a collision.

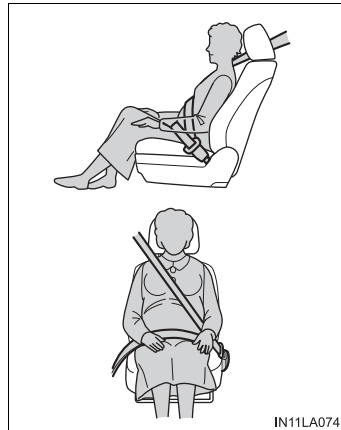
**■ People suffering illness**

Obtain medical advice and wear the seat belt in the proper way. (→P. 30)

⚠ WARNING**■ When the children are in the vehicle**

Do not allow children to play with the seat belt. If the seat belt becomes twisted around a child's neck, it may lead to choking or other serious injuries that could result in death.

If this occurs and the buckle cannot be unfastened, scissors should be used to cut the belt.

■ Seat belt pretensioners

● Do not place anything, such as a cushion, on the front passenger's seat. Doing so will disperse the passenger's weight, which prevents the sensor from detecting the passenger's weight properly. As a result, the seat belt pretensioner for the front passenger's seat may not activate in the event of a collision.

● If the pretensioner has activated, the SRS warning light will come on. In that case, the seat belt cannot be used again and must be replaced at your Toyota dealer.

■ Adjustable shoulder anchor

Always make sure the shoulder belt is positioned across the center of your shoulder. The belt should be kept away from your neck, but not falling off your shoulder. Failure to do so could reduce the amount of protection in an accident and cause death or serious injuries in the event of a sudden stop, sudden swerve or accident. (→P. 33)

■ When using the third center seat belt

Do not use the third center seat belt with either buckle released. Fastening only one of the buckles may result in death or serious injury in case of sudden braking, sudden swerving or a collision.

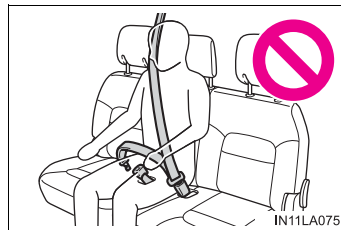

 **WARNING****■ Seat belt damage and wear**

- Do not damage the seat belts by allowing the belt, plate, or buckle to be jammed in the door.
- Inspect the seat belt system periodically. Check for cuts, fraying, and loose parts. Do not use a damaged seat belt until it is replaced. Damaged seat belt cannot protect an occupant from death or serious injury.
- Ensure that the belt and plate are locked and the belt is not twisted. If the seat belt does not function correctly, immediately contact your Toyota dealer.
- Replace the seat assembly, including the belts, if your vehicle has been involved in a serious accident, even if there is no obvious damage.
- Do not attempt to install, remove, modify, disassemble or dispose of the seat belts. Have any necessary repairs carried out by your Toyota dealer. Inappropriate handling may lead to incorrect operation.

■ Using a seat belt extender

- Do not wear the seat belt extender if you can fasten the seat belt without the extender.
- Do not use the seat belt extender when installing a child restraint system because the belt will not securely hold the child restraint system, increasing the risk of death or serious injury in the event of an accident.
- The personalized extender may not be safe on another vehicle, when used by another person, or at a different seating position other than the one originally intended.

 **NOTICE****■ Using a seat belt extender**

When releasing the seat belt, press on the buckle release button on the extender, not on the seat belt.
This helps prevent damage to the vehicle interior and the extender itself.

SRS airbags

The SRS airbags inflate when the vehicle is subjected to certain types of severe impacts that may cause significant injury to the occupants. They work together with the seat belts to help reduce the risk of death or serious injury.

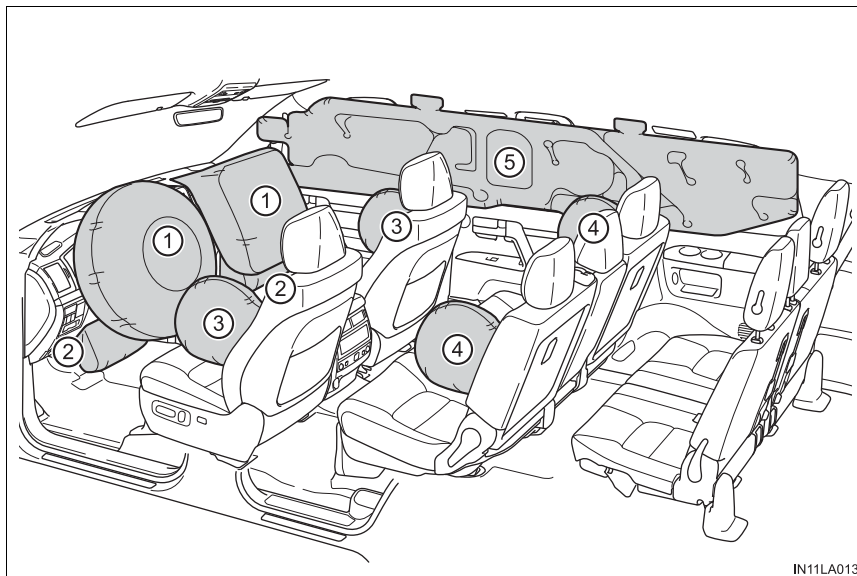

◆ SRS front airbags

- ① SRS driver airbag/front passenger airbag
Can help protect the head and chest of the driver and front passenger from impact with interior components
- ② SRS knee airbags
Can help provide driver and front passenger protection

◆ SRS side and curtain shield airbags

- ③ SRS front side airbags
Can help protect the torso of the front seat occupants
- ④ SRS rear side airbags
Can help protect the torso of occupants in the second outboard seats
- ⑤ SRS curtain shield airbags
Can help protect primarily the head of occupants in the outboard seats

1

For safety and security

SRS airbag system components

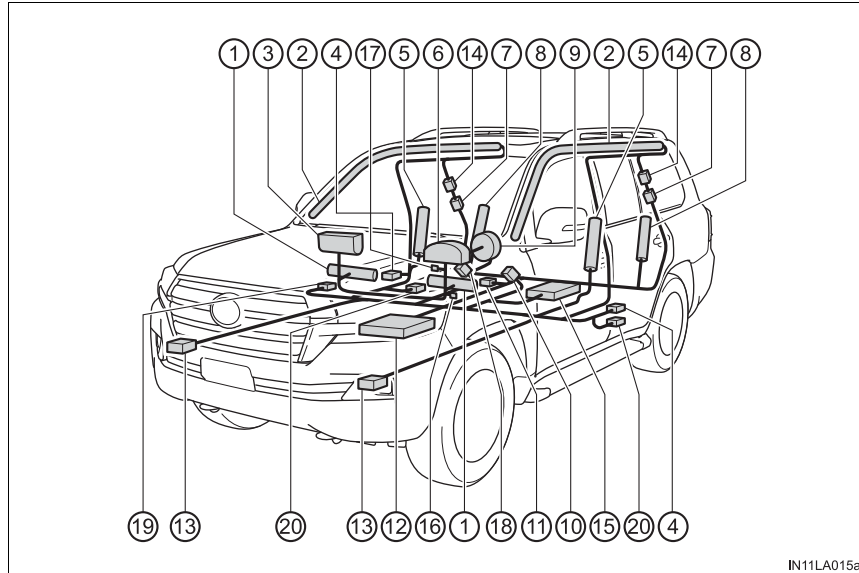

- | | |
|--|--|
| ① Knee airbags | ⑬ Front impact sensors |
| ② Curtain shield airbags | ⑭ Seat belt pretensioners (second outboard seats) |
| ③ Front passenger airbag | ⑮ Driver's seat position sensor |
| ④ Side impact sensors (front door) | ⑯ "RSCA OFF" switch |
| ⑤ Front side airbags | ⑰ "AIR BAG ON" and "AIR BAG OFF" indicator lights |
| ⑥ SRS warning light and "RSCA OFF" indicator light | ⑱ Front passenger's seat belt buckle switch |
| ⑦ Side impact sensors (rear) | ⑲ Front passenger occupant classification system (ECU and sensors) |
| ⑧ Rear side airbags (second outboard seat) | ⑳ Seat belt pretensioners and force limiters (front seats) |
| ⑨ Driver airbag | |
| ⑩ Driver's seat belt buckle switch | |
| ⑪ Safing sensor (rear) | |
| ⑫ Airbag sensor assembly | |

Your vehicle is equipped with ADVANCED AIRBAGS designed based on the US motor vehicle safety standards (FMVSS208). The airbag sensor assembly (ECU) controls airbag deployment based on information obtained from the sensors etc. shown in the system components diagram above. This information includes crash severity and occupant information. As the airbags deploy, a chemical reaction in the inflators quickly fills the airbags with non-toxic gas to help restrain the motion of the occupants.

 **WARNING**

■ **SRS airbag precautions**

Observe the following precautions regarding the SRS airbags. Failure to do so may cause death or serious injury.

- The driver and all passengers in the vehicle must wear their seat belts properly.

The SRS airbags are supplemental devices to be used with the seat belts.

- The SRS driver airbag deploys with considerable force, and can cause death or serious injury especially if the driver is very close to the airbag. The National Highway Traffic Safety Administration (NHTSA) advises:

Since the risk zone for the driver's airbag is the first 2 - 3 in. (50 - 75 mm) of inflation, placing yourself 10 in. (250 mm) from your driver airbag provides you with a clear margin of safety. This distance is measured from the center of the steering wheel to your breastbone. If you sit less than 10 in. (250 mm) away now, you can change your driving position in several ways:

- Move your seat to the rear as far as you can while still reaching the pedals comfortably.
- Slightly recline the back of the seat. Although vehicle designs vary, many drivers can achieve the 10 in. (250 mm) distance, even with the driver seat all the way forward, simply by reclining the back of the seat somewhat. If reclining the back of your seat makes it hard to see the road, raise yourself by using a firm, non-slippery cushion, or raise the seat if your vehicle has that feature.
- If your steering wheel is adjustable, tilt it downward. This points the airbag toward your chest instead of your head and neck.

The seat should be adjusted as recommended by NHTSA above, while still maintaining control of the foot pedals, steering wheel, and your view of the instrument panel controls.

⚠ WARNING

■ **SRS airbag precautions**

- If the seat belt extender has been connected to the front seat belt buckles but the seat belt extender has not also been fastened to the latch plate of the seat belt, the SRS front airbags will judge that the driver and front passenger are wearing the seat belt even though the seat belt has not been connected. In this case, the SRS front airbags may not activate correctly in a collision, resulting in death or serious injury in the event of collision. Be sure to wear the seat belt with the seat belt extender.

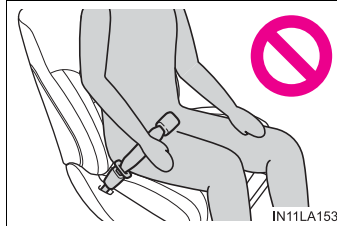

- The SRS front passenger airbag also deploys with considerable force, and can cause death or serious injury especially if the front passenger is very close to the airbag. The front passenger seat should be as far from the airbag as possible with the seatback adjusted, so the front passenger sits upright.
- Improperly seated and/or restrained infants and children can be killed or seriously injured by a deploying airbag. An infant or child who is too small to use a seat belt should be properly secured using a child restraint system. Toyota strongly recommends that all infants and children be placed in the rear seats of the vehicle and properly restrained. The rear seats are safer for infants and children than the front passenger seat. (→P. 58)

- Do not sit on the edge of the seat or lean against the dashboard.

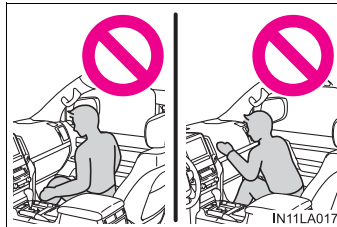

- Do not allow a child to stand in front of the SRS front passenger airbag unit or sit on the knees of a front passenger.
- Do not allow the front seat occupants to hold items on their knees.

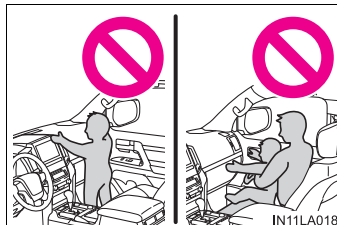

⚠ WARNING**■ SRS airbag precautions**

- Do not lean against the door, the roof side rail or the front, side and rear pillars.

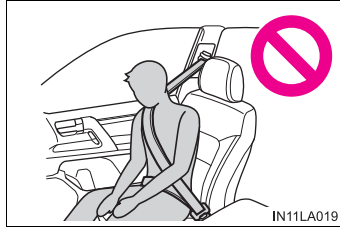

- Do not allow anyone to kneel on the passenger seats toward the door or put their head or hands outside the vehicle.

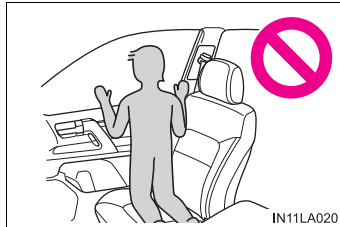

- Do not attach anything to or lean anything against areas such as the dashboard, steering wheel pad and lower portion of the instrument panel. These items can become projectiles when the SRS driver, front passenger and knee airbags deploy.

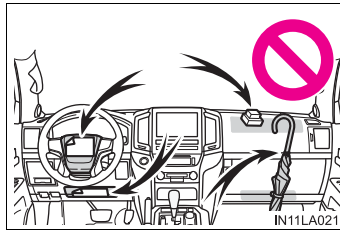

⚠ WARNING

■ SRS airbag precautions

- Do not attach anything to areas such as a door, windshield glass, side door glass, front, side or rear pillars, roof side rail and assist grip.

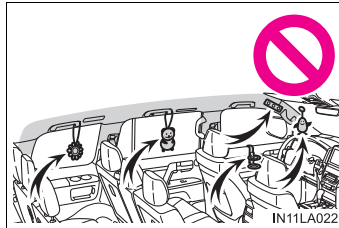

- Do not hang coat hangers or other hard objects on the coat hooks. All of these items could become projectiles and may cause death or serious injury, should the SRS curtain shield airbags deploy.
- If the vinyl cover is put on the area where the SRS knee airbag will deploy, be sure to remove it.
- Do not use seat accessories which cover the parts where the SRS side airbags inflate as they may interfere with inflation of the airbags. Such accessories may prevent the side airbags from activating correctly, disable the system or cause the side airbags to inflate accidentally, resulting in death or serious injury.
- Do not strike or apply significant levels of force to the area of the SRS airbag components.
Doing so can cause the SRS airbags to malfunction.
- Do not touch any of the component parts immediately after the SRS airbags have deployed (inflated) as they may be hot.
- If breathing becomes difficult after the SRS airbags have deployed, open a door or window to allow fresh air in, or leave the vehicle if it is safe to do so. Wash off any residue as soon as possible to prevent skin irritation.
- If the areas where the SRS airbags are stored, such as the steering wheel pad and front, side and rear pillar garnishes, are damaged or cracked, have them replaced by your Toyota dealer.
- Do not place anything, such as a cushion, on the front passenger's seat. Doing so will disperse the passenger's weight, which prevents the sensor from detecting the passenger's weight properly. As a result, the SRS front airbags for the front passenger may not deploy in the event of a collision.

 **WARNING****■ Modification and disposal of SRS airbag system components**

Do not dispose of your vehicle or perform any of the following modifications without consulting your Toyota dealer. The SRS airbags may malfunction or deploy (inflate) accidentally, causing death or serious injury.

- Installation, removal, disassembly and repair of the SRS airbags
- Repairs, modifications, removal or replacement of the steering wheel, instrument panel, dashboard, seats, seat upholstery, front, side and rear pillars or roof side rails
- Repairs or modifications of the front fender, front bumper, or side of the occupant compartment
- Installation of a grille guard (bull bars, kangaroo bar, etc.), snow plows, winches or roof luggage carrier
- Modifications to the vehicle's suspension system
- Installation of electronic devices such as mobile two-way radios and CD players
- Modifications to your vehicle for a person with a physical disability

■ If the SRS airbags deploy (inflate)

- Slight abrasions, burns, bruising etc., may be sustained from SRS airbags, due to the extremely high speed deployment (inflation) by hot gases.
- A loud noise and white powder will be emitted.
- Parts of the airbag module (steering wheel hub, airbag cover and inflator) as well as the front seats, parts of the front, side and rear pillars and roof side rails, may be hot for several minutes. The airbag itself may also be hot.
- The windshield may crack.
- For Safety Connect subscribers, if the SRS airbags deploy or in the event of a severe rear-end collision, the system is designed to send an emergency call to the response center, notifying them of the vehicle's location (without needing to push the "SOS" button) and an agent will attempt to speak with the occupants to ascertain the level of emergency and assistance required. If the occupants are unable to communicate, the agent automatically treats the call as an emergency and helps to dispatch the necessary emergency services. (→P. 427)

■ SRS airbag deployment conditions (SRS front airbags)

- The SRS front airbags will deploy in the event of an impact that exceeds the set threshold level (the level of force corresponding to an approximately 12 - 18 mph [20 - 30 km/h] frontal collision with a fixed wall that does not move or deform).

However, this threshold velocity will be considerably higher in the following situations:

- If the vehicle strikes an object, such as a parked vehicle or sign pole, which can move or deform on impact
- If the vehicle is involved in an underride collision, such as a collision in which the front of the vehicle “underrides”, or goes under, the bed of a truck
- Depending on the type of collision, it is possible that only the seat belt pretensioners will activate.
- The SRS front airbags for the front passenger will not activate if there is no passenger sitting in the front passenger seat. However, the SRS front airbags for the front passenger may deploy if luggage is put in the seat, even if the seat is unoccupied.

■ SRS airbag deployment conditions (SRS side and curtain shield airbags)

- The SRS side and curtain shield airbags will deploy in the event of an impact that exceeds the set threshold level (the level of force corresponding to the impact force produced by an approximately 3300 lb. [1500 kg] vehicle colliding with the vehicle cabin from a direction perpendicular to the vehicle orientation at an approximate speed of 12 - 18 mph [20 - 30 km/h]).
- The SRS curtain shield airbags will deploy in the event of vehicle rollover.
- The SRS side and curtain shield airbags will deploy in the event of a severe frontal collision.

■ Conditions under which the SRS airbags may deploy (inflate), other than a collision

The SRS front airbags and SRS side and curtain shield airbags may also deploy if a serious impact occurs to the underside of your vehicle. Some examples are shown in the illustration.

- Hitting a curb, edge of pavement or hard surface
- Falling into or jumping over a deep hole
- Landing hard or falling

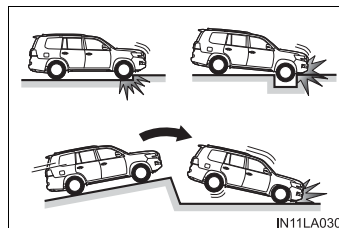

The SRS curtain shield airbags may also deploy under the situations shown in the illustration.

- The angle of vehicle tip-up is marginal
- The vehicle skids and hits a curb stone

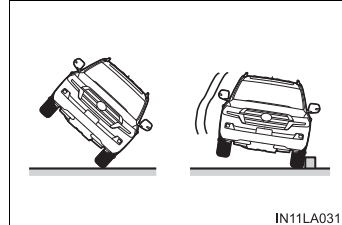

■ **Types of collisions that may not deploy the SRS airbags (SRS front airbags)**

The SRS front airbags do not generally inflate if the vehicle is involved in a side or rear collision, if it rolls over, or if it is involved in a low-speed frontal collision. But, whenever a collision of any type causes sufficient forward deceleration of the vehicle, deployment of the SRS front airbags may occur.

- Collision from the side
- Collision from the rear
- Vehicle rollover

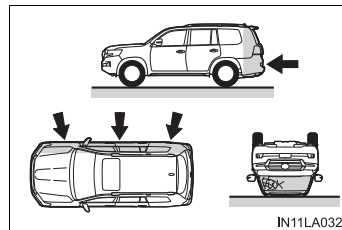

■ Types of collisions that may not deploy the SRS airbags (SRS side and curtain shield airbags)

The SRS side and curtain shield airbags may not activate if the vehicle is subjected to a collision from the side at certain angles, or a collision to the side of the vehicle body other than the passenger compartment.

- Collision from the side to the vehicle body other than the passenger compartment
- Collision from the side at an angle

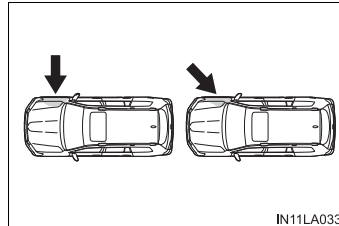

The SRS side airbags do not generally inflate if the vehicle is involved in a rear collision, if it rolls over, or if it is involved in a low-speed side or low-speed frontal collision.

- Collision from the rear
- Vehicle rollover

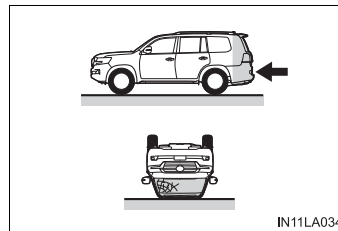

The SRS curtain shield airbags do not generally inflate if the vehicle is involved in a rear collision, if it pitches end over end, or if it is involved in a low-speed side or low-speed frontal collision.

- Collision from the rear
- Pitching end over end

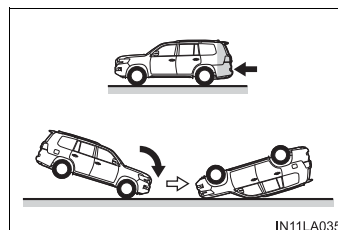

■ When to contact your Toyota dealer

In the following cases, the vehicle will require inspection and/or repair. Contact your Toyota dealer as soon as possible.

- Any of the SRS airbags have been inflated.
- The front of the vehicle is damaged or deformed, or was involved in an accident that was not severe enough to cause the SRS front airbags to inflate.

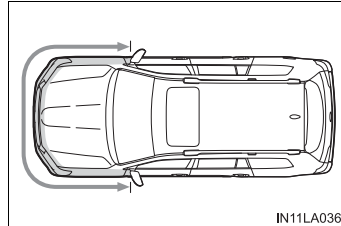

- A portion of a door or its surrounding area is damaged or deformed, or the vehicle was involved in an accident that was not severe enough to cause the SRS side and curtain shield airbags to inflate.

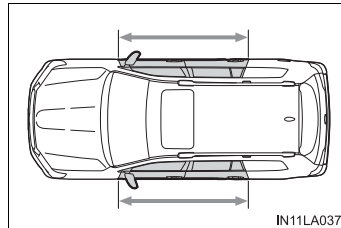

- The pad section of the steering wheel, dashboard near the front passenger airbag or lower portion of the instrument panel is scratched, cracked, or otherwise damaged.

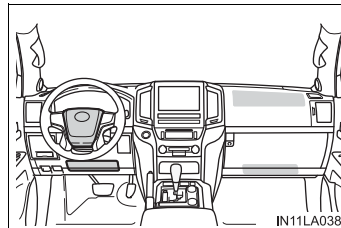

- The surface of the seats with the side airbag is scratched, cracked or otherwise damaged.

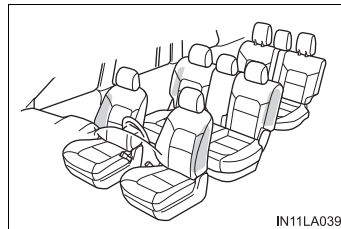

- The portion of the front, side and rear pillars or roof side rail garnishes (padding) containing the curtain shield airbags inside is scratched, cracked or otherwise damaged.

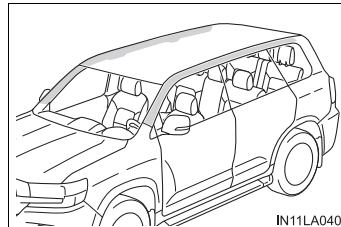

Deactivating the curtain shield airbags in a vehicle rollover

ON/OFF (hold for a few seconds)

The “RSCA OFF” indicator turns on (only when the engine switch is in IGNITION ON mode.)

The roll sensing function for the curtain shield airbags and seat belt pretensioners will turn back on automatically each time the engine switch is turned to IGNITION ON mode.

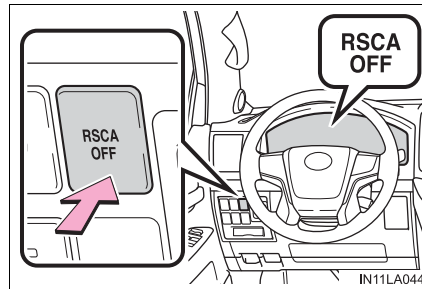

■ This switch only should be used

In a situation where the inflation is not desired (such as during extreme off road driving).

■ Operating conditions when the “RSCA OFF” indicator is on

- The curtain shield airbags and seat belt pretensioners will not activate in a vehicle rollover.
- The curtain shield airbags will activate in a severe side impact.
- The seat belt pretensioners will activate in a severe frontal collision.

⚠ WARNING

■ For normal driving

Make sure the “RSCA OFF” indicator is not turned on. If it is left on, the curtain shield airbag will not activate in the event of an accident, which may result in death or serious injury.

Front passenger occupant classification system

Your vehicle is equipped with a front passenger occupant classification system. This system detects the conditions of the front passenger seat and activates or deactivates the devices for the front passenger.

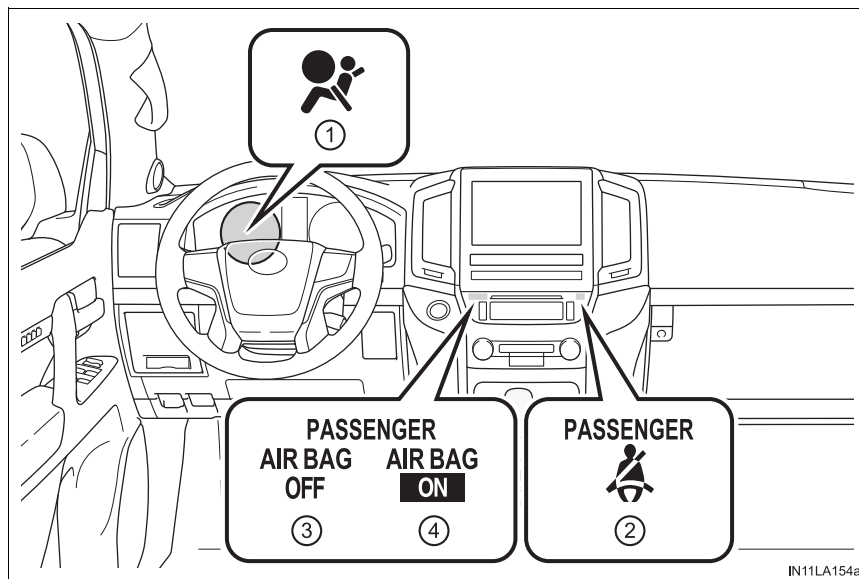

- ① SRS warning light
- ② Front passenger's seat belt reminder light
- ③ "AIR BAG OFF" indicator light
- ④ "AIR BAG ON" indicator light

Condition and operation in the front passenger occupant classification system

■ Adult*1

Indicator/ warning light	"AIR BAG ON" and "AIR BAG OFF" indicator lights	"AIR BAG ON"
	SRS warning light	Off
	Front passenger's seat belt reminder light	Off*2 or flashing*3
Devices	Front passenger airbag	Activated
	Side airbag on the front passenger seat	
	Curtain shield airbag in the front passenger side	
	Front passenger knee airbag	
	Front passenger's seat belt pretensioner	

■ Child*4 or child restraint system with infant*5

Indicator/ warning light	"AIR BAG ON" and "AIR BAG OFF" indicator lights	"AIR BAG OFF"*6
	SRS warning light	Off
	Front passenger's seat belt reminder light	Off*2 or flashing*3
Devices	Front passenger airbag	Deactivated
	Side airbag on the front passenger seat	Activated
	Curtain shield airbag in the front passenger side	
	Front passenger knee airbag	Deactivated
	Front passenger's seat belt pretensioner	Activated

■ Unoccupied

Indicator/ warning light	“AIR BAG ON” and “AIR BAG OFF” indicator lights	Not illuminated
	SRS warning light	Off
	Front passenger’s seat belt reminder light	
Devices	Front passenger airbag	Deactivated
	Side airbag on the front passenger seat	Activated
	Curtain shield airbag in the front passenger side	
	Front passenger knee airbag	Deactivated
	Front passenger’s seat belt pretensioner	

■ There is a malfunction in the system

Indicator/ warning light	“AIR BAG ON” and “AIR BAG OFF” indicator lights	“AIR BAG OFF”
	SRS warning light	On
	Front passenger’s seat belt reminder light	Off
Devices	Front passenger airbag	Deactivated
	Side airbag on the front passenger seat	Activated
	Curtain shield airbag in the front passenger side	
	Front passenger knee airbag	Deactivated
	Front passenger’s seat belt pretensioner	Activated

- *1: The system judges a person of adult size as an adult. When a smaller adult sits in the front passenger seat, the system may recognize him/her as a child depending on his/her physique and posture.
- *2: In the event the front passenger is wearing a seat belt.
- *3: In the event the front passenger does not wear a seat belt
- *4: When a larger child who has outgrown a child restraint system sits in the front passenger seat, the system may recognize him/her as an adult depending on his/her physique or posture.
- *5: Never install a rear-facing child restraint system on the front passenger seat. A forward-facing child restraint system should only be installed on the front passenger seat when it is unavoidable. (→P. 58)
- *6: In case the indicator light is not illuminated, consult this manual on how to install the child restraint system properly. (→P. 63)

 **WARNING****■ Front passenger occupant classification system precautions**

Observe the following precautions regarding the front passenger occupant classification system.

Failure to do so may cause death or serious injury.

- Wear the seat belt properly.
- Make sure the front passenger's seat belt plate has not been left inserted into the buckle before someone sits in the front passenger seat.
- Make sure the "AIR BAG OFF" indicator light is not illuminated when using the seat belt extender for the front passenger seat. If the "AIR BAG OFF" indicator light is illuminated, disconnect the extender tongue from the seat belt buckle, and reconnect the seat belt. Reconnect the seat belt extender after making sure the "AIR BAG ON" indicator light is illuminated. If you use the seat belt extender while the "AIR BAG OFF" indicator light is illuminated, the SRS airbags for the front passenger will not activate, which could cause death or serious injury in the event of a collision.
- Do not apply a heavy load to the front passenger seat or equipment (e.g. seatback pocket).
- Do not put weight on the front passenger seat by putting your hands or feet on the front passenger seat seatback from the rear passenger seat.
- Do not let a rear passenger lift the front passenger seat with their feet or press on the seatback with their legs.
- Do not put objects under the front passenger seat.

 **WARNING****■ Front passenger occupant classification system precautions**

- Do not recline the front passenger seatback so far that it touches the rear seat. This may cause the “AIR BAG OFF” indicator light to be illuminated, which indicates that the SRS airbags for the front passenger will not activate in the event of a severe accident. If the seatback touches the rear seat, return the seatback to a position where it does not touch the rear seat. Keep the front passenger seatback as upright as possible when the vehicle is moving. Reclining the seatback excessively may lessen the effectiveness of the seat belt system.
- If an adult sits in the front passenger seat, the “AIR BAG ON” indicator light is illuminated. If the “AIR BAG OFF” indicator is illuminated, ask the passenger to sit up straight, well back in the seat, feet on the floor, and with the seat belt worn correctly. If the “AIR BAG OFF” indicator still remains illuminated, either ask the passenger to move to the rear seat, or if that is not possible, move the front passenger seat fully rearward.
- When it is unavoidable to install a forward-facing child restraint system on the front passenger seat, install the child restraint system on the front passenger seat in the proper order. (→P. 63)
- Do not modify or remove the front seats.
- Do not kick the front passenger seat or subject it to severe impact. Otherwise, the SRS warning light may come on to indicate a malfunction of the front passenger occupant classification system. In this case, contact your Toyota dealer immediately.
- Child restraint systems installed on the second seat should not contact the front seatbacks.
- Do not use a seat accessory, such as a cushion and seat cover, that covers the seat cushion surface.
- Do not modify or replace the upholstery of the front seat.

Safety information for children

Observe the following precautions when children are in the vehicle.

Use a child restraint system appropriate for the child, until the child becomes large enough to properly wear the vehicle's seat belt.

- It is recommended that children sit in the rear seats to avoid accidental contact with the shift lever, wiper switch etc.
- Use the rear door child-protector lock or the window lock switch to avoid children opening the door while driving or operating the power window accidentally. (→P. 109, 150)
- Do not let small children operate equipment which may catch or pinch body parts, such as the power window, hood, back door, seats etc.

WARNING

Never leave children unattended in the vehicle, and never allow children to have or use the key.

Children may be able to start the vehicle or shift the vehicle into neutral. There is also a danger that children may injure themselves by playing with the windows, the moon roof or other features of the vehicle. In addition, heat build-up or extremely cold temperatures inside the vehicle can be fatal to children.

Child restraint systems

A child restraint system for a small child or baby must itself be properly restrained on the seat with the LATCH anchors or the lap portion of the lap/shoulder belt.

The laws of all 50 states of the U.S.A. and Canada now require the use of child restraint systems.

Points to remember

Studies have shown that installing a child restraint on a rear seat is much safer than installing one on the front passenger seat.

- Choose a child restraint system that suits your vehicle and is appropriate to the age and size of the child.
- For installation details, follow the instructions provided with the child restraint system.

General installation instructions are provided in this manual.

(→P. 63)

Types of child restraints

Child restraint systems are classified into the following 3 types according to the age and size of the child:

- ▶ Rear facing — Infant seat/convertible seat
- ▶ Forward facing — Convertible seat

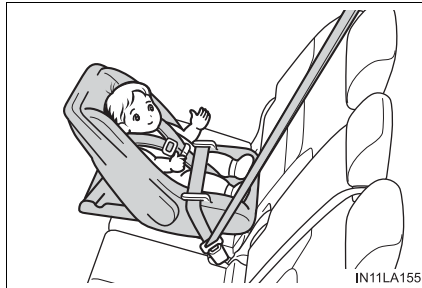

- ▶ Booster seat

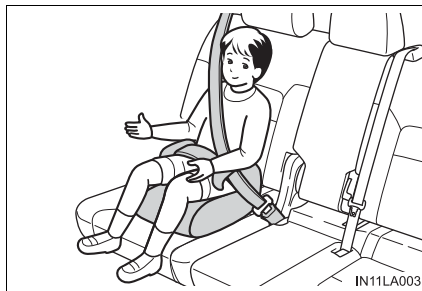

■ When installing a child restraint system on the front passenger seat

When you have to use a child restraint system on the front passenger seat, adjust the following:

- The seatback to the most upright position
- The seat cushion to the fully rearward and highest position
- The seat belt height to the lowest position

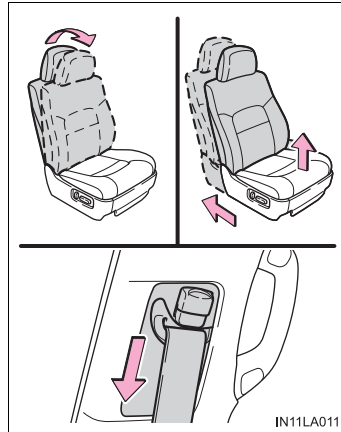
**■ Selecting an appropriate child restraint system**

- Use a child restraint system appropriate for the child until the child becomes large enough to properly wear the vehicle's seat belt.
- If the child is too large for a child restraint system, sit the child on a rear seat and use the vehicle's seat belt. (→P. 30)

 **WARNING****■ Child restraint precautions**

- For effective protection in automobile accidents and sudden stops, a child must be properly restrained, using a seat belt or child restraint system depending on the age and size of the child. Holding a child in your arms is not a substitute for a child restraint system. In an accident, the child can be crushed against the windshield, or between you and the vehicle's interior.
- Toyota strongly urges the use of a proper child restraint system that conforms to the size of the child, installed on the rear seat. According to accident statistics, the child is safer when properly restrained in the rear seat than in the front seat.
- Never install a rear-facing child restraint system on the front passenger seat even if the "AIR BAG OFF" indicator light is illuminated. In the event of an accident, the force of the rapid inflation of the front passenger airbag can cause death or serious injury to the child if the rear-facing child restraint system is installed on the front passenger seat.
- A forward-facing child restraint system may be installed on the front passenger seat only when it is unavoidable. A child restraint system that requires a top tether strap should not be used in the front passenger seat since there is no top tether strap anchor for the front passenger seat. Adjust the seatback as upright as possible and always move the seat as far back as possible even if the "AIR BAG OFF" indicator light is illuminated, because the front passenger airbag could inflate with considerable speed and force. Otherwise, the child may be killed or seriously injured.
- Do not use the seat belt extender when installing a child restraint system on the front or rear passenger seat. If installing a child restraint system with the seat belt extender connected to the seat belt, the seat belt will not securely hold the child restraint system, which could cause death or serious injury to the child or other passengers in the event of a sudden stop, sudden swerve or accident.
- Do not allow the child to lean his/her head or any part of his/her body against the door or the area of the seat, front, side and rear pillars or roof side rails from which the SRS side airbags or SRS curtain shield airbags deploy even if the child is seated in the child restraint system. It is dangerous if the SRS side airbags and curtain shield airbags inflate, and the impact could cause death or serious injury to the child.
- Make sure you have complied with all installation instructions provided by the child restraint manufacturer and that the system is properly secured. If it is not secured properly, it may cause death or serious injury to the child in the event of a sudden stop, sudden swerve or accident.

 **WARNING****■ When children are in the vehicle**

Do not allow children to play with the seat belt. If the seat belt becomes twisted around a child's neck, it may lead to choking or other serious injuries that could result in death.

If this occurs and the buckle cannot be unfastened, scissors should be used to cut the belt.

■ When the child restraint system is not in use

- Keep the child restraint system properly secured on the seat even if it is not in use. Do not store the child restraint system unsecured in the passenger compartment.

- If it is necessary to detach the child restraint system, remove it from the vehicle or store it securely in the luggage compartment. This will prevent it from injuring passengers in the event of a sudden stop, sudden swerve or accident.

Installing child restraints

Follow the child restraint system manufacturer's instructions. Firmly secure the child restraints using the LATCH anchors or a seat belt. Attach the top tether strap when installing a child restraint.

The lap/shoulder belt can be used if your child restraint system is not compatible with the LATCH (Lower Anchors and Tethers for Children) system.

Child restraint LATCH anchors

LATCH anchors are provided for the second outboard seat. (Buttons displaying the location of the anchors are attached to the seats.)

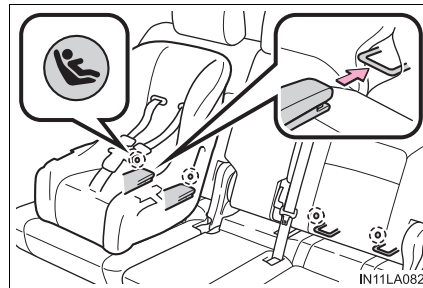

Seat belts equipped with a child restraint locking mechanism (ALR/ELR belts except driver's seat belt) (→P. 34)

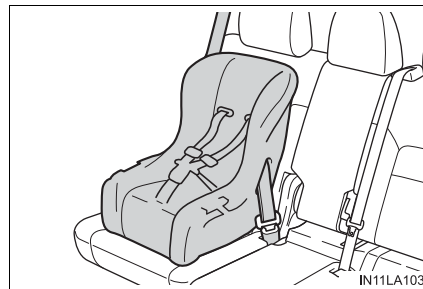

Anchor bracket (for top tether strap)

Anchor brackets are provided for all second seats.

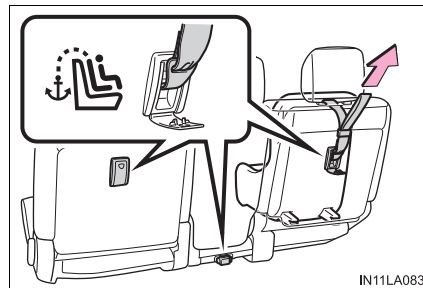

Installation with LATCH system

- 1 Fold the seatback forward and then adjust it as upright as possible.

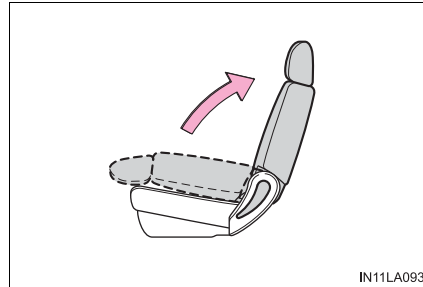

- 2 Take off the covers between the seat cushion and seatback, then confirm the position of the LATCH anchors below the symbol in the seatback.

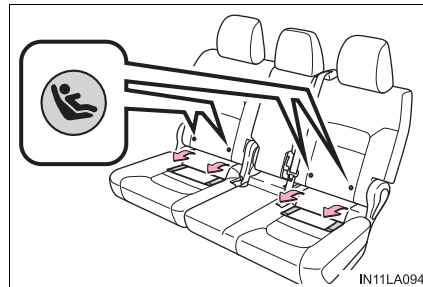
**► Type A**

- 3 Latch the hooks of the lower straps onto the LATCH anchors.
- 4 If the child restraint has a top tether strap, the top tether strap should be latched onto the top tether strap anchor.

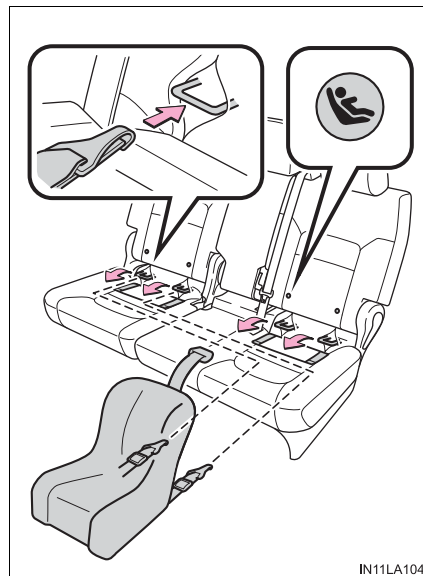

► Type B

- 3 Latch the buckles onto the LATCH anchors.
- 4 If the child restraint has a top tether strap, the top tether strap should be latched onto the top tether strap anchor.

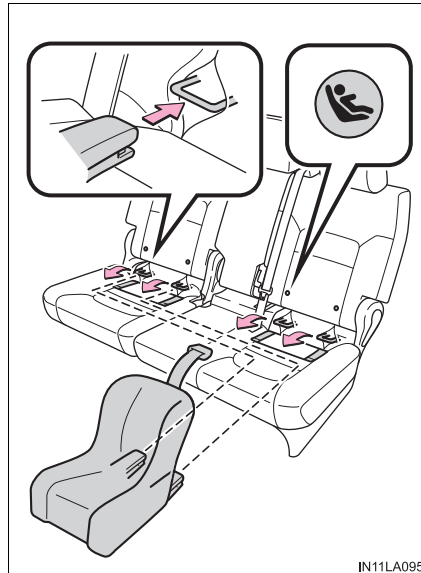

Installing child restraints using a seat belt (child restraint lock function belt)

■ Rear-facing — Infant seat/convertible seat

- 1 Fold the seatback while pulling the seatback angle lever. Return the seatback and secure it at the first lock position. (→P. 129)

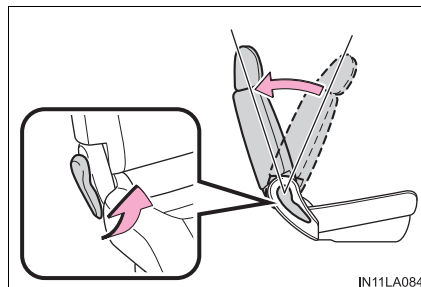

- 2 Place the child restraint system on the second or third seat facing the rear of the vehicle.

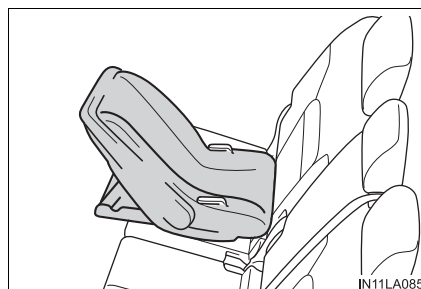

- 3 Run the seat belt through the child restraint system and insert the plate into the buckle. Make sure that the belt is not twisted.

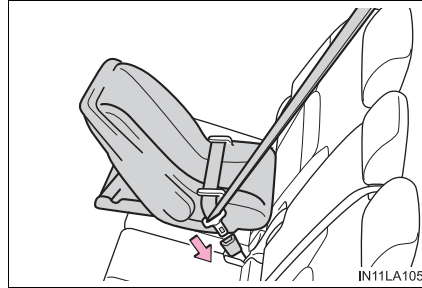

- 4 Fully extend the shoulder belt and then allow it to retract slightly in order to activate the ALR lock mode.

Lock mode allows the seat belt to retract only.

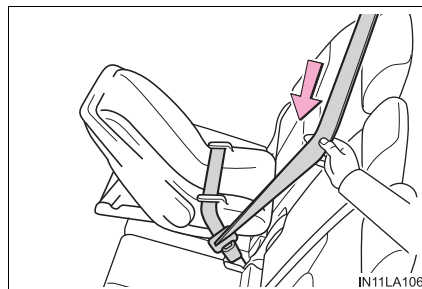

- 5 While pushing the child restraint system down into the seat, allow the shoulder belt to retract until the child restraint system is securely in place.

After the shoulder belt has retracted to a point where there is no slack in the belt, pull the belt to check that it cannot be extended.

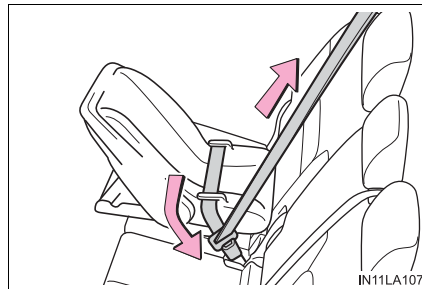

■ Forward-facing — Convertible seat

- 1 Fold the seatback while pulling the seatback angle lever. Return the seatback and secure it at the first lock position. (→P. 129)

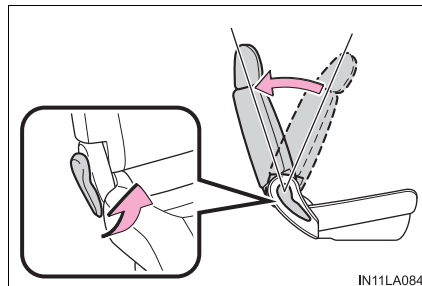

- 2 Place the child restraint system on the second or third seat facing the front of the vehicle.

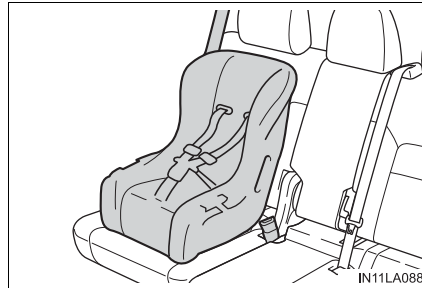

- 3 Run the seat belt through the child restraint system and insert the plate into the buckle. Make sure that the belt is not twisted.

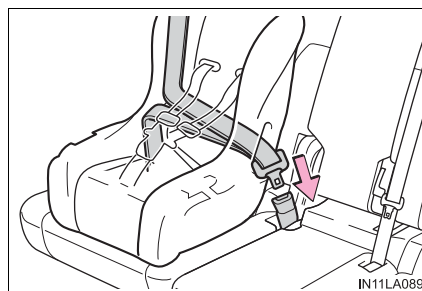

- 4 Fully extend the shoulder strap and then allow it to retract slightly into the ALR lock mode.

Lock mode allows the seat belt to retract only.

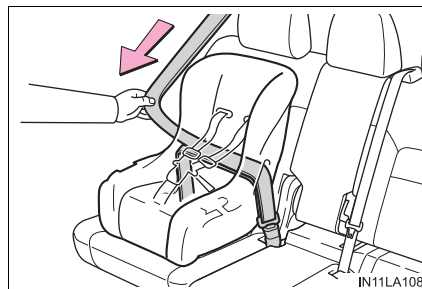

- 5 While pushing the child restraint system into the seat, allow the shoulder belt to retract until the child restraint system is securely in place.

After the shoulder belt has retracted to a point where there is no slack in the belt, pull the belt to check that it cannot be extended.

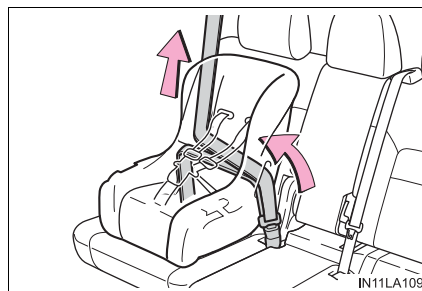

- 6 If the child restraint system has a top tether strap, the top tether strap should be latched onto the top tether strap anchor. (→P. 69)

■ Booster seat

- 1 Fold the seatback while pulling the seatback angle lever. Return the seatback and secure it at the first lock position. (→P. 129)

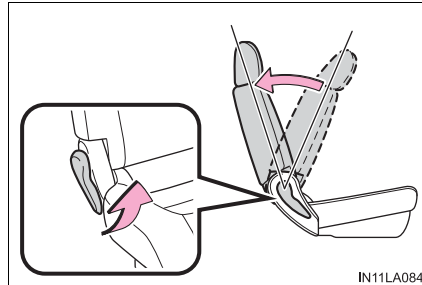

- 2 Place the child restraint system on the seat facing the front of the vehicle.

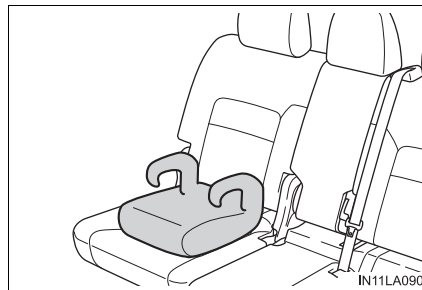

- 3 Sit the child in the child restraint system. Fit the seat belt to the child restraint system according to the manufacturer's instructions and insert the plate into the buckle. Make sure that the belt is not twisted.

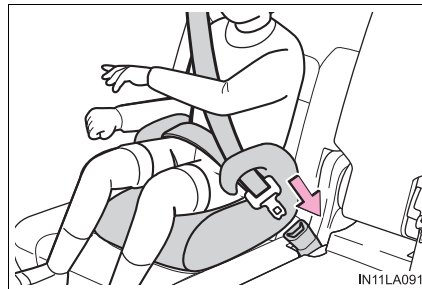

Check that the shoulder belt is correctly positioned over the child's shoulder, and that the lap belt is as low as possible. (→P. 30)

Removing a child restraint system installed with a seat belt

Press the buckle release button and fully retract the seat belt.

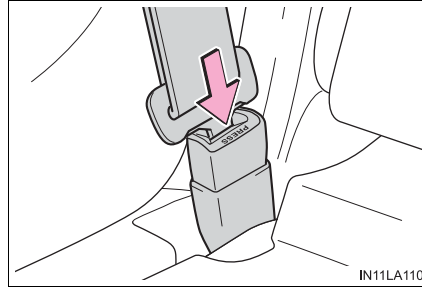

Child restraint systems with a top tether strap

► Second outboard seats

- 1 Secure the child restraint system using a seat belt or LATCH anchors, and move the head restraint in place at the upmost position.

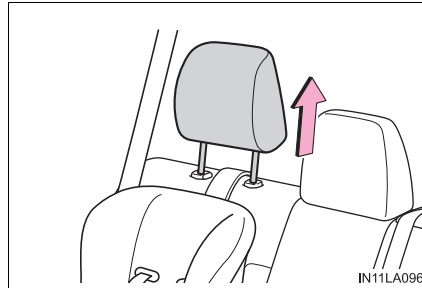

- 2 Open the anchor bracket cover, latch the hook onto the anchor bracket and tighten the top tether strap.

Make sure the top tether strap is securely latched.

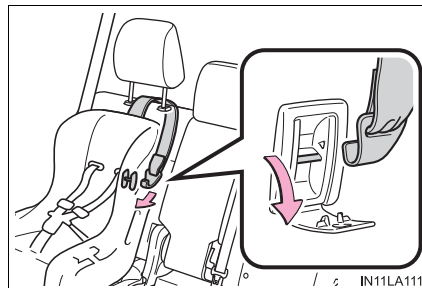

- 3 Adjust the head restraint to the downmost position.

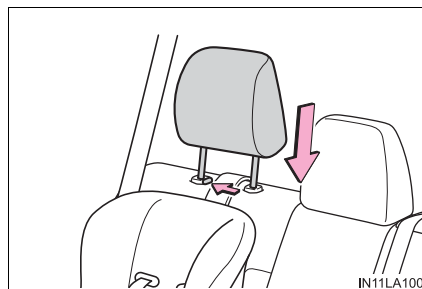

► Second center seat

- 1 Secure the child restraint system using a seat belt and remove the head restraint.

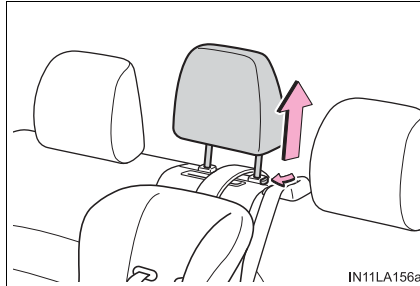

- 2 Open the anchor bracket cover, latch the hook onto the anchor bracket and tighten the top tether strap. Make sure the top tether strap is securely latched.

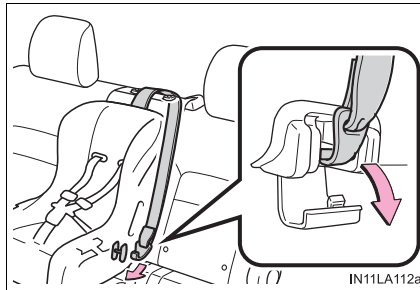

- 3 Install the head restraint.

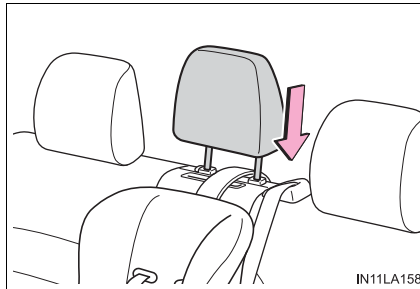

■ Laws and regulations pertaining to anchorages

The LATCH system conforms to FMVSS225.

Child restraint systems conforming to FMVSS213 specifications can be used.

This vehicle is designed to conform to the SAE J1819.

⚠ WARNING

■ **When installing a booster seat**

To prevent the belt from going into ALR lock mode, do not fully extend the shoulder belt. ALR mode causes the belt to tighten only. This could cause injury or discomfort to the child. (→P. 34)

■ **When installing a child restraint system**

Follow the directions given in the child restraint system installation manual and fix the child restraint system securely in place.

If the child restraint system is not correctly fixed in place, the child or other passengers may be seriously injured or even killed in the event of sudden braking, sudden swerving or an accident.

- If the driver's seat interferes with the child restraint system and prevents it from being attached correctly, attach the child restraint system to the right-hand rear seat.
- Adjust the front passenger seat so that it does not interfere with the child restraint system.
- Child restraint system installed on the third seat should not contact the second seatbacks.
- Only put a forward-facing child restraint system on the front seat when unavoidable. When installing a forward-facing child restraint system on the front passenger seat, move the seat as far back as possible even if the "AIR BAG OFF" indicator light is illuminated. Failure to do so may result in death or serious injury if the airbags deploy (inflate).

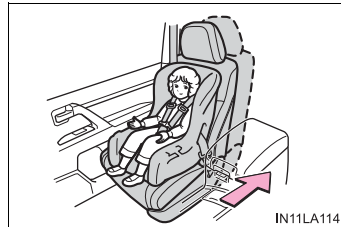
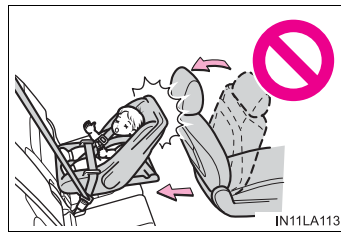

- When installing a child restraint system on the second center seat, adjust both seat cushions to the same position and align both seatbacks at the same angle. Otherwise, the child restraint system cannot be securely restrained and this may cause death or serious injuries in the event of sudden braking, sudden swerving or an accident.
- When using the LATCH anchors for a child restraint system, move the seat as far back as possible, with the seatback close to the child restraint system.

 **WARNING****■ When installing a child restraint system**

- When a booster seat is installed, always ensure that the shoulder belt is positioned across the center of the child's shoulder. The belt should be kept away from the child's neck, but not so that it could fall off the child's shoulder. Failing to do so may result in death or serious injury in the event of sudden braking, sudden swerving or an accident.
- Ensure that the belt and plate are securely locked and the seat belt is not twisted.
- Shake the child restraint system left and right, and forward and backward to ensure that it has been securely installed.
- After securing a child restraint system, never adjust the seat.
- Follow all installation instructions provided by the child restraint system manufacturer.
- When securing some types of child restraint systems in second or third row seats, it may not be possible to properly use the seat belts in positions next to the child restraint without interfering with it or affecting seat belt effectiveness. Be sure your seat belt fits snugly across your shoulder and low on your hips. If it does not, or if it interferes with the child restraint, move to a different position. Failure to do so may result in death or serious injury.

■ Do not use a seat belt extender

If a seat belt extender is used when installing a child restraint system, the seat belt will not securely hold the child restraint system, which could cause death or serious injury to the child or other passengers in the event of sudden braking, sudden swerving or an accident.

■ To correctly attach a child restraint system to the anchors

When using the LATCH anchors, be sure that there are no foreign objects around the anchors and that the seat belt is not caught behind the child restraint system. Make sure the child restraint system is securely attached, or it may cause death or serious injury to the child or other passengers in the event of a sudden stop, sudden swerve or accident.

Exhaust gas precautions

Harmful substance to the human body is included in exhaust gases if inhaled.

WARNING

Exhaust gases include harmful carbon monoxide (CO), which is colorless and odorless. Observe the following precautions.

Failure to do so may cause exhaust gases enter the vehicle and may lead to an accident caused by light-headedness, or may lead to death or a serious health hazard.

■ Important points while driving

- Keep the back door closed.
- If you smell exhaust gases in the vehicle even when the back door is closed, open the windows and have the vehicle inspected at your Toyota dealer as soon as possible.

■ When parking

- If the vehicle is in a poorly ventilated area or a closed area, such as a garage, stop the engine.
- Do not leave the vehicle with the engine running for a long time.
If such a situation cannot be avoided, park the vehicle in an open space and ensure that exhaust fumes do not enter the vehicle interior.
- Do not leave the engine running in an area with snow build-up, or where it is snowing. If snowbanks build up around the vehicle while the engine is running, exhaust gases may collect and enter the vehicle.

■ Exhaust pipe

The exhaust system needs to be checked periodically. If there is a hole or crack caused by corrosion, damage to a joint or abnormal exhaust noise, be sure to have the vehicle inspected and repaired by your Toyota dealer.

1

For safety and security

Engine immobilizer system

The vehicle's keys have built-in transponder chips that prevent the engine from starting if a key has not been previously registered in the vehicle's on-board computer.

Never leave the keys inside the vehicle when you leave the vehicle.

This system is designed to help prevent vehicle theft but does not guarantee absolute security against all vehicle thefts.

The indicator light flashes after the engine switch has been turned off to indicate that the system is operating.

The indicator light stops flashing after the engine switch has been turned to ACCESSORY or IGNITION ON mode to indicate that the system has been canceled.

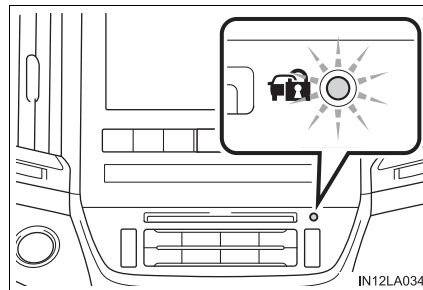

■ System maintenance

The vehicle has a maintenance-free type engine immobilizer system.

■ Conditions that may cause the system to malfunction

- If the key is in contact with a metallic object
- If the key is in close proximity to or touching a key to the security system (key with a built-in transponder chip) of another vehicle

■ Certifications for the engine immobilizer system

- ▶ For vehicles sold in the U.S.A., Hawaii, Guam, Saipan and Puerto Rico

FCC ID: NI4TMIMB-3

This device complies with part 15 of the FCC Rules. Operation is subject to the following two conditions: (1) This device may not cause harmful interference, and (2) this device must accept any interference received, including interference that may cause undesired operation.

Changes or modifications not expressly approved by the party responsible for compliance could void the user's authority to operate the equipment.

⚠ WARNING**■ Certifications for the engine immobilizer system**

Changes or modifications not expressly approved by the party responsible for compliance could void the user's authority to operate the equipment.

⚠ NOTICE**■ To ensure the system operates correctly**

Do not modify or remove the system. If modified or removed, the proper operation of the system cannot be guaranteed.

Alarm

The alarm

The alarm uses light and sound to give an alert when an intrusion is detected.

The alarm is triggered in the following situations when the alarm is set:

- A locked door is unlocked or opened in any way other than using the entry function or wireless remote control. (The doors will lock again automatically.)
- The hood is opened.
- The battery is reconnected.

Setting the alarm system

Close the doors and hood, and lock all the doors using the entry function or wireless remote control. The system will be set automatically after 30 seconds.

The indicator light changes from being on to flashing when the system is set.

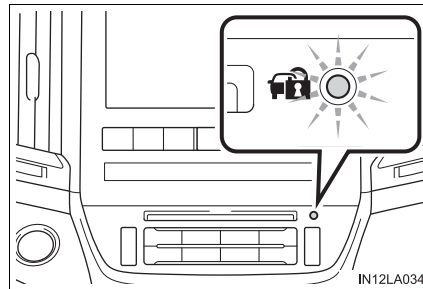

Deactivating or stopping the alarm

Do one of the following to deactivate or stop the alarms:

- Unlock the doors using the entry function or wireless remote control.
- Turn the engine switch to ACCESSORY or IGNITION ON mode, or start the engine. (The alarm will be deactivated or stopped after a few seconds.)

■ System maintenance

The vehicle has a maintenance-free type alarm system.

■ Items to check before locking the vehicle

To prevent unexpected triggering of the alarm and vehicle theft, make sure of the following.

- Nobody is in the vehicle.
- The windows and moon roof are closed before the alarm is set.
- No valuables or other personal items are left in the vehicle.

■ Triggering of the alarm

The alarm may be triggered in the following situations:
(Stopping the alarm deactivates the alarm system.)

- The doors are unlocked using the mechanical key.

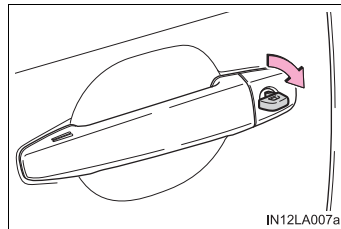

- A person inside the vehicle opens a door or hood, or unlocks the vehicle using an inside lock button.



- The battery is recharged or replaced when the vehicle is locked. (→P. 543)

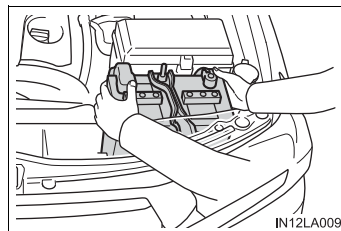

■ Alarm-operated door lock

In the following cases, depending on the situation, the door may automatically lock to prevent improper entry into the vehicle:

- When a person remaining in the vehicle unlocks the door and the alarm is activated.
- While the alarm is activated, a person remaining in the vehicle unlocks the door.
- When recharging or replacing the battery.

**NOTICE****■ To ensure the system operates correctly**

Do not modify or remove the system. If modified or removed, the proper operation of the system cannot be guaranteed.

2. Instrument cluster

Warning and indicators
lights 80
Gauges and meters 85
Multi-information display 89
Fuel consumption
information 98

Warning and indicators lights

The warning and indicators lights on the instrument cluster and center panel inform the driver of the status of the vehicle's various systems.



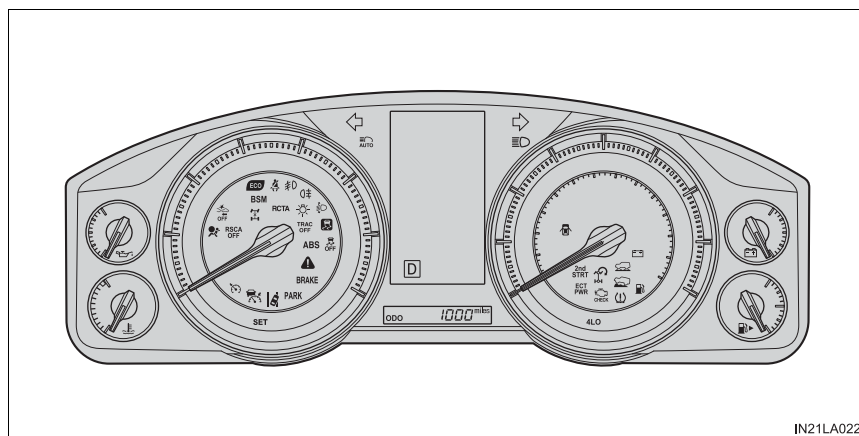











For the purpose of explanation, the following illustration display all warning lights and indicators illuminated.



The units used on the speedometer may differ depending on the target region.

Warning lights

Warning lights inform the driver of malfunctions in any of the vehicle's systems.

^{*1} 	Brake system warning light (→P. 510)		Open door warning light (→P. 512)
^{*1} 	Charging system warning light (→P. 510)		Driver's seat belt reminder light (→P. 512)
^{*1} 	Malfunction indicator lamp (→P. 510)	^{*3} 	Front passenger's seat belt reminder light (→P. 512)
^{*1} 	SRS warning light (→P. 510)		Low fuel level warning light (→P. 512)
^{*1} 	ABS warning light (→P. 511)	^{*1} 	Master warning light (→P. 512)
^{*1} 	Slip indicator (→P. 511)	(if equipped)	
^{*1} 		^{*1} 	Tire pressure warning light (→P. 512)
^{*1, 2} 	PCS warning light (→P. 511)	^{*1, 2} 	Automatic headlight leveling system warning light (→P. 512)
(if equipped)			

















^{*1}: These lights turn on when the engine switch is turned to IGNITION ON mode to indicate that a system check is being performed. They will turn off after the engine is started, or after a few seconds. There may be a malfunction in a system if the lights do not come on, or turn off. Have the vehicle inspected by your Toyota dealer.













^{*2}: The light flashes to indicate a malfunction.

^{*3}: This light illuminates on the center panel.

Indicators

The indicators inform the driver of the operating state of the vehicle's various systems.

	Turn signal indicator (→P. 205)		Power mode indicator (→P. 200)
	Headlight high beam indicator (→P. 206)		Second start mode indicator (→P. 200)
	Headlight indicator (→P. 205)		Low speed four-wheel drive indicator light (→P. 280)
	Automatic High Beam indicator (→P. 209)		Center differential lock indicator (→P. 280)
	Fog light indicator (→P. 214)		^{*1, 4} "AIR BAG ON/OFF" indicator (→P. 51)
	Cruise control indicator (→P. 257, 269)	 (if equipped)	Dynamic radar cruise control indicator (→P. 257)
	^{*1, 2} Slip indicator (→P. 358)		Turn Assist function indicator (→P. 284)
	^{*1, 3} TRAC OFF indicator (→P. 359)		^{*1} Crawl Control indicator (→P. 284)

 *1, 3 VSC OFF indicator (→P. 359)	 (if equipped)	LDA indicators (→P. 248)
 SET Cruise control "SET" indicator (→P. 257, 269)	 *1 BSM	BSM (Blind Spot Monitor) indicator (→P. 343)
 Multi-terrain Select indicator (→P. 289)	 RCTA	RCTA (Rear Cross Traffic Alert) indicator (→P. 351)
 *1 ECO Eco Driving Indicator Light (→P. 84)	 *5, 6	BSM (Blind Spot Monitor) outside rear view mirror indicator (→P. 343)
 *1, 3 RSCA OFF "RSCA OFF" indicator (→P. 51)	 D	Shift position and shift range indicators (→P. 199)
 *1, 2 PCS OFF PCS warning light (→P. 233) (If equipped)	 PARK	Parking brake indicator (→P. 204)

*1: These lights turn on when the engine switch is turned to IGNITION ON mode to indicate that a system check is being performed. They will turn off after the engine is on, or after a few seconds. There may be a malfunction in a system if the lights do not turn on, or turn off. Have the vehicle inspected by your Toyota dealer.

*2: The light flashes to indicate that the system is operating.

*3: The light turns on when the system is turned off.

*4: This light illuminates on the center panel.

*5: In order to confirm operation, the BSM outside rear view mirror indicators illuminate in the following situations:

- When the engine switch is turned to IGNITION ON mode while the system is set to on.
- When the system is set to on while the engine switch is in IGNITION ON mode.

If the system is functioning correctly, the BSM outside rear view mirror indicators will turn off after a few seconds.

If the BSM outside rear view mirror indicators do not illuminate or do not turn off, there may be a malfunction with the system.

If this occurs, have the vehicle inspected by your Toyota dealer.

*6: This light illuminates on the outside rear view mirrors.

■ Eco Driving Indicator Light

During Eco-Friendly acceleration operation (Eco driving), Eco Driving Indicator Light will turn on. When the acceleration exceeds Zone of Eco driving (→P. 96), or when the vehicle is stopped, the light turns off.

Eco Driving Indicator Light will not operate in the following conditions:

- The shift lever is in any position other than D.
- The vehicle is set to second start mode or power mode. (→P. 199)
- The vehicle speed is approximately 81 mph (130 km/h) or higher.
- The Crawl Control is operating. (→P. 284)

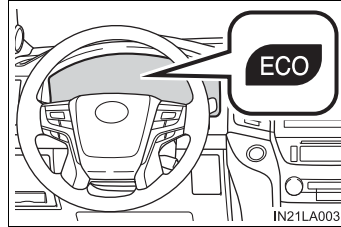

⚠ WARNING

■ If a safety system warning light does not come on

Should a safety system light such as the Multi Terrain ABS and the SRS warning light not come on when you start the engine, this could mean that these systems are not available to help protect you in an accident, which could result in death or serious injury. Have the vehicle inspected by your Toyota dealer immediately if this occurs.

Gauges and meters

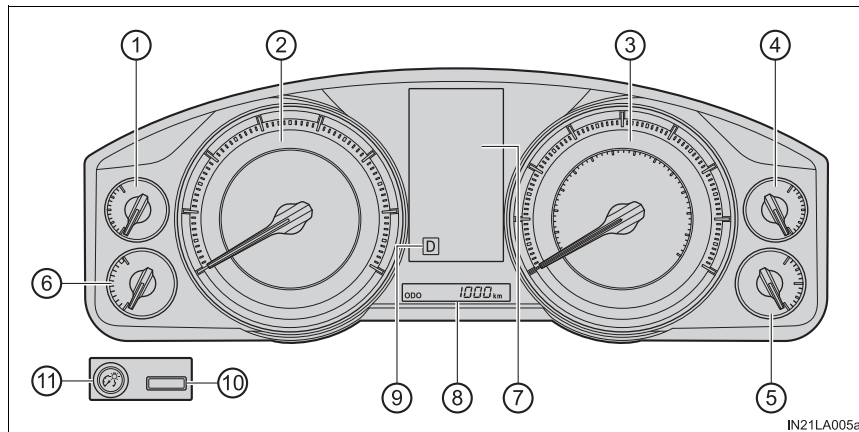

The units used on the speedometer may differ depending on the target region.

- ① Engine oil pressure gauge
Displays the engine oil pressure
- ② Tachometer
Displays the engine speed in revolutions per minute
- ③ Speedometer
Displays the vehicle speed
- ④ Voltmeter
Displays the charge state
- ⑤ Fuel gauge
Displays the quantity of fuel remaining in the tank
- ⑥ Engine coolant temperature gauge
Displays the engine coolant temperature
- ⑦ Multi-information display
Presents the driver with a variety of driving-related data (→P. 89)
- ⑧ Odometer and trip meter display
Odometer:
Displays the total distance the vehicle has been driven
Trip meter:
Displays the distance the vehicle has been driven since the meter was last reset. Trip meters A and B can be used to record and display different distances independently.

2

Instrument cluster

- ⑨ Shift position and shift range display
Displays the selected shift position or selected shift range (→P. 199)
- ⑩ Odometer/trip meter display change button
Switches between odometer and trip meter displays
- ⑪ Instrument panel light control dial
The brightness of the instrument panel light can be adjusted

Changing the display

Pressing this button switches between odometer and trip meter.

- ① Odometer
- ② Trip meter A*
- ③ Trip meter B*

*: Pushing and holding the button will reset the trip meter.

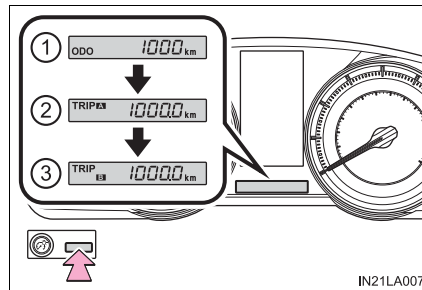

Instrument panel light control

The brightness of the instrument panel lights can be adjusted.

- ① Darker
- ② Brighter

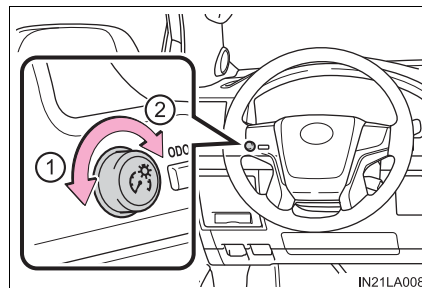

■ The meters and display illuminate when

The engine switch is in IGNITION ON mode.

■ The brightness of the instrument panel lights

When the tail lights are turned on, the meter's brightness will be reduced slightly unless the meter brightness level adjustment is set to the brightest setting.

If the tail lights are turned on when the surroundings are dark, the meter's brightness will reduce slightly. However, when the surroundings are bright, such as during the daytime, the meter's brightness will not be reduced even if the tail lights are turned on.

■ Customization

The meter display can be customized on the multi-information display.
(Customizable features: →P. 574)

⚠ WARNING**■ The information display at low temperatures**

Allow the interior of the vehicle to warm up before using the liquid crystal information display. At extremely low temperatures, the information display monitor may respond slowly, and display changes may be delayed.

For example, there is a lag between the driver's shifting and the new gear number appearing on the display. This lag could cause the driver to down-shift again, causing rapid and excessive engine braking and possibly an accident resulting in death or injury.

 NOTICE**■ To prevent damage to the engine and its components**

- Do not let the indicator needle of the tachometer enter the red zone, which indicates the maximum engine speed.
- The engine may be overheating if the engine coolant temperature gauge is in the red zone (H). In this case, immediately stop the vehicle in a safe place, and check the engine after it has cooled completely. (→P. 546)

■ Voltmeter

When the voltmeter indicates 19 V or higher or 9 V or lower while the engine is running, there may be a battery or charging system malfunction. Have the vehicle inspected at your Toyota dealer.

■ Engine oil pressure gauge

When the value of the engine oil pressure gauge drops while the engine is running, stop the vehicle in a safe place immediately and check the amount of engine oil. (→P. 452)

When the oil pressure drops even though the engine oil amount has not decreased, or if the oil pressure does not increase when engine oil is added, contact your Toyota dealer, as there may be a problem with the lubrication system.

Multi-information display

Display contents

The following information will be displayed when a menu icon is selected. (→P. 91)

Some of the information may be displayed automatically depending on the situation.

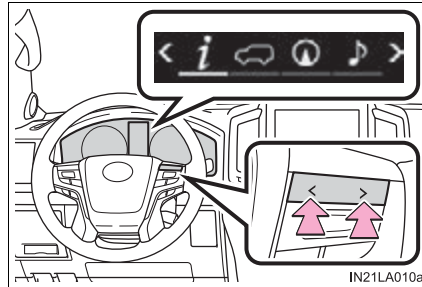

Drive information

Select to display various drive data. (→P. 92)



Vehicle information display (if equipped)

Select to display the vehicle information. (→P. 94)



Navigation system-linked display (if equipped)

Select to display the following navigation system-linked information.

- Route guidance
- Compass display (north-up display/heading-up display)



Audio system-linked display (if equipped)

Select to enable selection of an audio source or track on the display using the meter control switches.



Driving assist system information (if equipped)

Select to display the operational status of the following systems:

- Dynamic radar cruise control (→P. 257)
When the vehicle is in constant speed control mode (→P. 265), the menu icon will change to .
- LDA (Lane Departure Alert with steering control) (→P. 248)



Warning message display

Select to display warning messages and measures to be taken if a malfunction is detected. (→P. 519)

- When there are no current warning messages, “No Messages” is displayed.
- When there are multiple warning messages,  can be used to switch the displayed warning message.



Settings display

Select to change the meter display settings and the operation settings of some vehicle functions. (→P. 94)

Operating the meter control switches

The multi-information display is operated using the meter control switches.

- ① Switching displayed items
- ② Operate up and down:
Switches screens and moves the cursor

Press:

Enters, moves to next screen*, and turns functions on/off*

*: For some functions

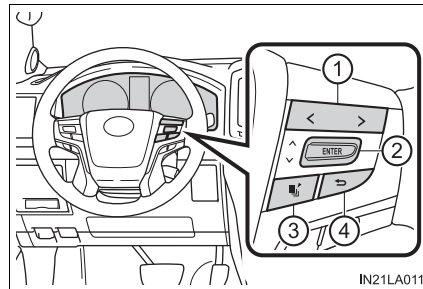

- ③ Press: Displays the screen registered as the top screen
When no screen has been registered, the drive information screen will be displayed.
Press and hold: Registers the currently displayed screen as the top screen
When the confirmation screen is displayed, select yes to register the screen. If the selected screen cannot be registered, a registration failure message will be shown.
- ④ Return to the previous screen

2

Instrument cluster

Drive information

Items displayed can be switched by operating  up and down.

■ Drive information

4 of the following items can be registered and displayed as the drive information 1 and the drive information 2 (2 items on each screen).

Refer to P. 94 for the registration method of the drive information 1 and the drive information 2.

- Current fuel consumption (bar type/value type)

Displays the current rate of fuel consumption.

- Average fuel consumption (after reset^{*2}/after start/after refuel)^{*1}

Displays the average fuel consumption since the function was reset, the engine was started, and the vehicle was refueled, respectively.

- Average vehicle speed (after reset^{*2}/after start)

Displays the average vehicle speed since the function was reset and the engine was started, respectively.

- Elapsed time (after reset^{*2}/after start)

Displays the elapsed time since the function was reset and the engine was started, respectively

- Distance (driving range/after start)

Displays the estimated maximum distance that can be driven with the quantity of fuel remaining and the distance driven after the engine was started respectively.

- This distance is computed based on your average fuel consumption. As a result, the actual distance that can be driven may differ from that displayed.
- When only a small amount of fuel is added to the tank, the display may not be updated. When refueling, turn the engine switch off. If the vehicle is refueled without turning the engine switch off, the display may not be updated.

*1: Use the displayed average fuel consumption as a reference.

*2: The function can be reset by pressing  for longer than 1 second when the item to reset is displayed. If there is more than one item that can be reset, the item selection screen will appear.

- **Eco Indicator (Eco Driving Indicator Zone Display)**

→P. 96

- **Speed**

Displays the vehicle speed.

- **Sway warning (if equipped)**

Detects the sway of the vehicle within a lane, which is often associated with a decrease in the driver's attention level, and displays the decrease in attention using a bar display.

The shorter the bar length, the more the driver may need to rest.

This display is a part of the LDA (Lane Departure Alert with steering control) system. The display is enabled when the operating conditions of the vehicle sway warning are met. (→P. 248)

- **Blank screen (display off)**

Drive information is not displayed.

Vehicle information

Items displayed can be switched by operating  up and down.

■ Front tire angle (if equipped)

Displays the direction of the front tires.

The tire direction is displayed in 3 stages for both left and right, in accordance with the angle of the tire.

If a battery terminal is disconnected and reconnected, the display may be disabled temporarily. After driving the vehicle for a while, the display will be enabled.

■ Tire inflation pressure (if equipped)

Displays inflation pressure of each tire

The inflation pressure of the spare tire will be displayed.



■ Oil maintenance

Displays the remaining distance before the next maintenance is required.



Settings display

The settings of some features can be changed by using the meter control switches.

■ Setting procedure





- 1 On the setting screen, choose the desired item using , and then press .

- For functions that can be enabled or disabled, the function switches between on and off each time  is pressed.
- For functions that allow to select operation contents, display contents, etc., the setting screen is displayed.

- 2 Select the desired setting by operating , and then press .

To stop the selection, press  to return to the previous screen.

■ Setting items

-  LDA (Lane Departure Alert)*
Select to set up LDA. (→P. 574)
 - Alert sensitivity
 - Sway warning
 - Sway sensitivity
-  BSM (Blind Spot Monitor)*
Select to activate/deactivate BSM. (→P. 574)
 - BSM on/off
 - RCTA (Rear Cross Traffic Alert) on/off
- Scheduled maintenance
Select to reset the message indicating maintenance is required.
- Oil maintenance
Select to reset the engine oil maintenance information
- Meter settings
Select to set the following items.
 - Language
Select to change the language on the display.
 - Units
Select to change the unit for measure of the fuel consumption.
 -  Eco Driving Indicator Light (if equipped)
Select to activate/deactivate the Eco Driving Indicator Light.
(→P. 84)
 -  switch settings
You can register 1 screen as the top screen. To register, press and hold  while the desired screen is displayed.
 - Drive information 1 and 2
Select to select up to 2 items that will be displayed on a drive information screen, up to 2 drive information screens can be set.
 - Pop-up display
Select to set the following pop-up displays (→P. 96), which may appear in some situations, on/off.

- Accent color
Select to change the accent colors on the screen, such as the cursor color.
- Initialization
Select to reset the meter display settings.

*: If equipped

■ Eco Driving Indicator

- ① Eco Driving Indicator Light (→P. 84)
- ② Eco Driving Indicator Zone Display
Suggests the Zone of Eco driving with current Eco driving ratio based on acceleration.
- ③ Eco driving ratio based on acceleration
If the acceleration exceeds Zone of Eco driving, the right side of Eco Driving Indicator Zone Display will illuminate.
- ④ Zone of Eco driving

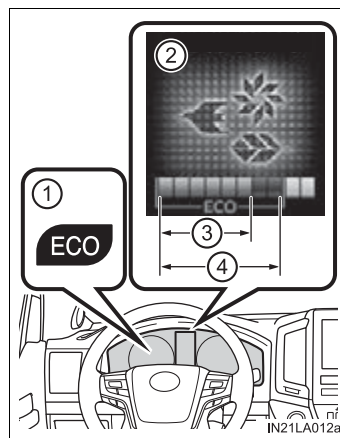

■ When disconnecting and reconnecting battery terminals

The drive information will be reset (only items that can be reset manually).

■ Pop-Up display

The pop-up display is displayed on the multi-information display according to the operating conditions of the following functions:

- Route guidance display of the navigation system-linked system (if equipped)
- Incoming call display of the hands-free phone system (if equipped)

The pop-up display function can be disabled.

■ Tire inflation pressure

- It may take a few minutes to display the tire inflation pressure after the engine switch is turned to IGNITION ON mode. It may also take a few minutes to display the tire inflation pressure after inflation pressure has been adjusted.
- “---” may be displayed if the tire information cannot be determined due to unfavorable radio wave conditions.
- Tire inflation pressure changes with temperature. The displayed values may also be different from the values measured using a tire pressure gauge.

■ When setting up the display

Stop the vehicle in a safe place, apply the parking brake, and shift the shift lever to P

■ Suspension of the settings display

In the following situations, the settings display using the meter control switches will be suspended.

- When a warning message appears on the multi-information display
- When the vehicle begins to move

■ Liquid crystal display

Small spots or light spots may appear on the display. This phenomenon is characteristic of liquid crystal displays, and there is no problem continuing to use the display.



WARNING

■ Caution for use while driving

For safety, avoid operating the meter control switch while driving as much as possible, and do not look continuously at the multi-information display while driving. Stop the vehicle and operate the meter control switch. Failure to do so may cause a steering wheel operation error, resulting in an unexpected accident.

■ Cautions while setting up the display

As the engine needs to be running during setting up the display, ensure that the vehicle is parked in a place with adequate ventilation. In a closed area such as a garage, exhaust gases including harmful carbon monoxide (CO) may collect and enter the vehicle. This may lead to death or a serious health hazard.



NOTICE

■ While setting up the display

To prevent battery discharge, ensure that the engine is running while setting up the display features.

Fuel consumption information

The fuel consumption information can be displayed on the navigation system or multimedia system screen.

Display the trip information or past record screen

Press the “INFO/APPS” button, and then select “Fuel Consumption” on the screen.

Trip information

- ① Reset the trip information data
- ② Previous fuel consumption per minute
- ③ Current fuel consumption
- ④ Average vehicle speed
- ⑤ Elapsed time
- ⑥ Cruising range

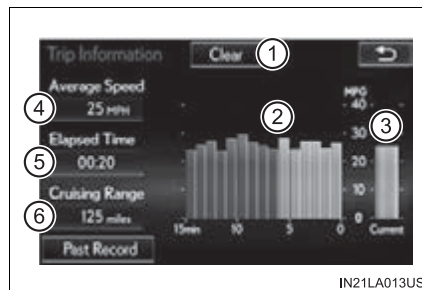

Average fuel consumption for the past 15 minutes is divided by color into past averages and averages attained since the engine switch was last turned to IGNITION ON mode. Use the displayed average fuel consumption as a reference.

These images are examples only, and may vary slightly from actual conditions.

Past record

- ① Reset the past record data
- ② Best recorded fuel consumption
- ③ Average fuel consumption
- ④ Previous fuel consumption record
- ⑤ Update the past record data

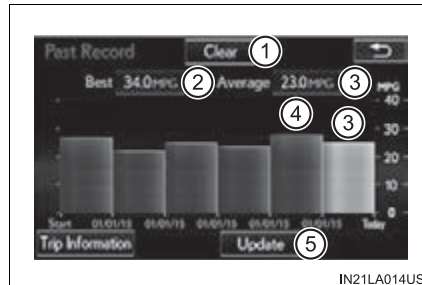

These images are examples only, and may vary slightly from actual conditions.

■ Resetting the data

Selecting “Clear” on the “Trip information” screen will reset the trip information data.

Selecting “Clear” on the “Past record” screen will reset the past record data.

■ Updating the past record data

Selecting “Update” on the “Past record” screen will update the past record data.

Also, the average fuel consumption displayed in the multi-information display will be reset at the same time.

■ Cruising range

Displays the estimated maximum distance that can be driven with the quantity of fuel remaining.

This distance is computed based on your average fuel consumption. As a result, the actual distance that can be driven may differ from that displayed.

**Operation of
each component****3****3-1. Key information**

Keys 102

**3-2. Opening, closing and
locking the doors**

Side doors 106

Back door 114

Smart key system 120

3-3. Adjusting the seats

Front seats 127

Rear seats 129

Driving position memory ... 136

Head restraints 140

**3-4. Adjusting the steering
wheel and mirrors**

Steering wheel 143

Inside rear view mirror 145

Outside rear view
mirrors 147**3-5. Opening, closing the
windows and moon roof**

Power windows 150

Moon roof 154

Keys

The keys

The following keys are provided with the vehicle.

- ① Electronic keys
 - Operating the smart key system (→P. 120)
 - Operating the wireless remote control function
- ② Mechanical keys
- ③ Key number plate

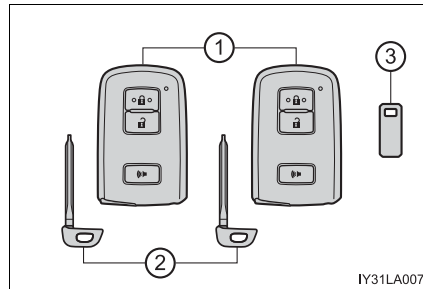

Wireless remote control

- ① Locks the doors (→P. 106)
- ② Unlocks the doors (→P. 106)
- ③ Opens the windows and moon roof* (→P. 106)
- ④ Sounds the alarm (→P. 103)

*: This setting must be customized at your Toyota dealer.

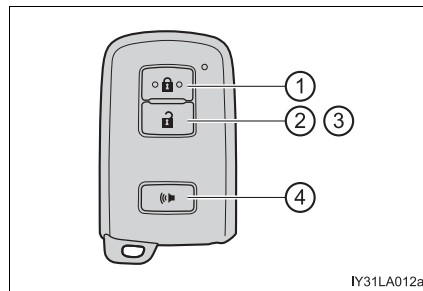

Using the mechanical key

To take out the mechanical key, push the release button and take the key out.

The mechanical key can only be inserted in one direction, as the key only has grooves on one side. If the key cannot be inserted in a lock cylinder, turn it over and re-attempt to insert it.

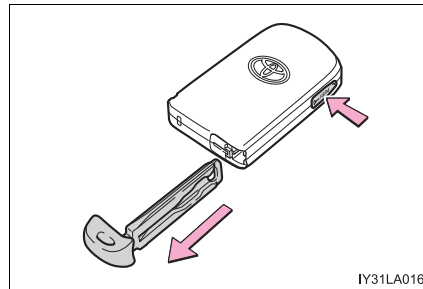

After using the mechanical key, store it in the electronic key. Carry the mechanical key together with the electronic key. If the electronic key battery is depleted or the entry function does not operate properly, you will need the mechanical key. (→P. 540)

Panic mode

When (Panic button) is pressed for longer than about one second, an alarm will sound intermittently and the vehicle lights will flash to deter any person from trying to break into or damage your vehicle.

To stop the alarm, press any button on the electronic key.

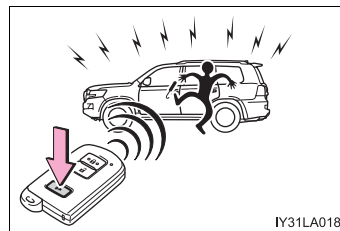

When required to leave the vehicle's key with a parking attendant

Lock the glove box as circumstances demand. (→P. 397)

Remove the mechanical key for your own use and provide the attendant with the electronic key only.

If you lose your mechanical keys

New genuine mechanical keys can be made by your Toyota dealer using another mechanical key and the key number stamped on your key number plate. Keep the plate in a safe place such as your wallet, not in the vehicle.

■ When riding in an aircraft

When bringing an electronic key onto an aircraft, make sure you do not press any buttons on the electronic key while inside the aircraft cabin. If you are carrying an electronic key in your bag etc., ensure that the buttons are not likely to be pressed accidentally. Pressing a button may cause the electronic key to emit radio waves that could interfere with the operation of the aircraft.

■ Electronic key battery depletion

- The standard battery life is 1 to 2 years.
- If the battery becomes low, an alarm will sound in the cabin when the engine stops.
- As the electronic key always receives radio waves, the battery will become depleted even if the electronic key is not used. The following symptoms indicate that the electronic key battery may be depleted. Replace the battery when necessary. (→P. 479)
 - The smart key system or the wireless remote control does not operate.
 - The detection area becomes smaller.
 - The LED indicator on the key surface does not turn on.
- To avoid serious deterioration, do not leave the electronic key within 3 ft. (1 m) of the following electrical appliances that produce a magnetic field:
 - TVs
 - Personal computers
 - Recharging cellular phones or cordless phones
 - Table lamps
 - Induction cookers

■ Replacing the key battery

→P. 479

 NOTICE**■ To prevent key damage**

- Do not drop the keys, subject them to strong shocks or bend them.
- Do not expose the keys to high temperatures for long periods of time.
- Do not get the keys wet or wash them in an ultrasonic washer, etc.
- Do not attach metallic or magnetic materials to the keys or place the keys close to such materials.
- Do not attach a sticker or anything else to the surface of the electronic key.
- Do not disassemble the keys.
- Do not place the keys near objects that produce magnetic fields, such as TVs, audio systems and induction cookers.
- Do not place the keys near medical electrical equipment such as low-frequency therapy equipment or microwave therapy equipment, and do not receive medical attention with the keys on your person.

■ Carrying the electronic key on your person

Carry the electronic key 3.9 in. (10 cm) or more away from electric appliances that are turned on. Radio waves emitted from electric appliances within 3.9 in. (10 cm) of the electronic key may interfere with the key, causing the key to not function properly.

■ In case of a smart key system malfunction or other key-related problems

Take your vehicle with all the electronic keys provided with your vehicle to your Toyota dealer.

■ When an electronic key is lost

If the electronic key remains lost, the risk of vehicle theft increases significantly. Visit your Toyota dealer immediately with all remaining electronic keys that were provided with your vehicle.

Side doors

The vehicle can be locked and unlocked using the entry function, wireless remote control or door lock switch.

Locking and unlocking the doors from the outside

◆ Smart key system

Carry the electronic key to enable this function.

- ① Grip the driver's door handle to unlock the door. Grip the passenger's door handle to unlock all the doors.*

Make sure to touch the sensor on the back of the handle.

The doors cannot be unlocked for 3 seconds after the doors are locked.

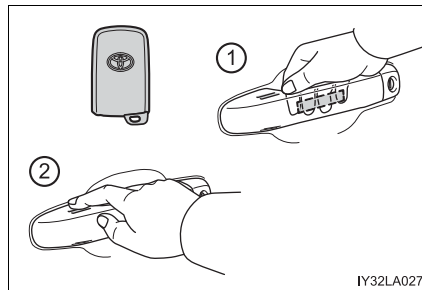

*: The door unlock settings can be changed. (→P. 112)

- ② Touch the lock sensor (the indentation on the upper part or lower part of the handle) to lock the doors.

Check that the door is securely locked.

◆ Wireless remote control

- ① Locks all the doors

Check that the door is securely locked.

- ② Unlocks all the doors

Pressing the button unlocks the driver's door. Pressing the button again unlocks the other doors.

Press and hold to open the windows and moon roof.*

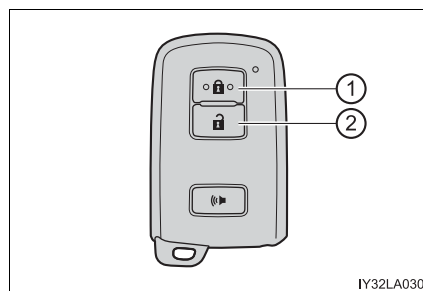

*: These settings must be customized at your Toyota dealer.

■ Operation signals

Doors: A buzzer sounds and the emergency flashers flash to indicate that the doors have been locked/unlocked. (Locked: once; Unlocked: twice)

Windows and moon roof: A buzzer sounds to indicate that the windows and moon roof are operating.

■ Security feature

If a door is not opened within approximately 60 seconds after the vehicle is unlocked, the security feature automatically locks the vehicle again.

■ When the door cannot be locked by the lock sensor on the upper part of the door handle

If the door will not lock even when the top-side sensor area is touched, try touching both the topside and underside sensor areas at the same time.

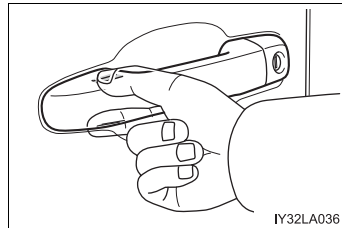
**■ Door lock buzzer**

If an attempt to lock the doors is made when a door is not fully closed, a buzzer sounds continuously. Fully close the door to stop the buzzer, and lock the vehicle once more.

■ Setting the alarm

Using the wireless remote control to lock the door will set the alarm system. (→P. 76)

■ If the smart key system or the wireless remote control does not operate properly

Use the mechanical key to lock and unlock the doors. (→P. 540)

Replace the battery with a new one if it is depleted. (→P. 479)

Locking and unlocking the doors from the inside

◆ Door lock switches

- ① Locks all the doors
- ② Unlocks all the doors

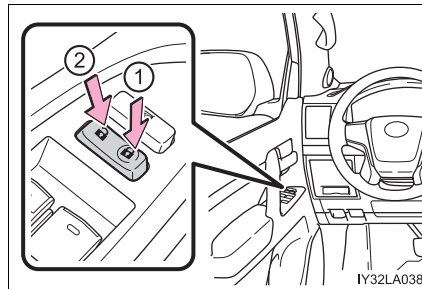

◆ Inside lock buttons

- ① Locks the door
- ② Unlocks the door

The front doors can be opened by pulling the inside handle even if the lock buttons are in the lock position.

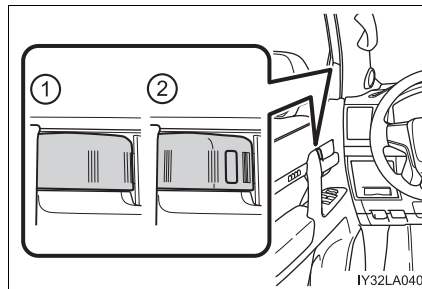

Locking the driver's door from the outside without a key

- 1 Move the inside lock button to the lock position.
- 2 Close the door.

The door cannot be locked if the engine switch is in ACCESSORY or IGNITION ON mode, or the electronic key is left inside the vehicle.

Depending on the position of the electronic key, the key may not be detected correctly and the door may be locked.

Rear door child-protector lock

The door cannot be opened from inside the vehicle when the lock is set.

- 1 Unlock
- 2 Lock

These locks can be set to prevent children from opening the rear doors. Push down on each rear door switch to lock both rear doors.

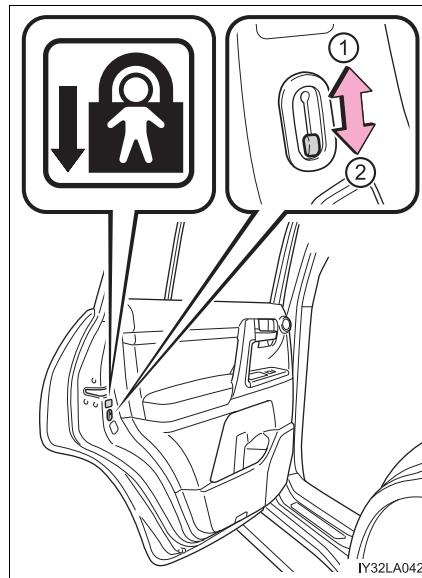

3

Operation of each component

Automatic door locking and unlocking systems

The following functions can be set or canceled:

For instructions on customizing, refer to P. 574.

Function	Operation
Shift position linked door locking function	Shifting the shift lever out of P locks all the doors.
Shift position linked door unlocking function	Shifting the shift lever to P unlocks all the doors.
Speed linked door locking function	All the doors are locked when the vehicle speed is approximately 12 mph (20 km/h) or higher.
Driver's door linked door unlocking function	All the doors are unlocked when the driver's door is opened within approximately 45 seconds after turning the engine switch off.

■ **Setting and canceling the functions**

To switch between setting and canceling, follow the procedure below:

- 1 Close all the doors and turn the engine switch to IGNITION ON mode. (Perform step 2 within 20 seconds.)

- 2 Shift the shift lever to P or N, and press and hold the door lock switch (🔒 or 🗝️) for approximately 5 seconds and then release.

The shift lever and switch positions corresponding to the desired function to be set are shown in the following table.

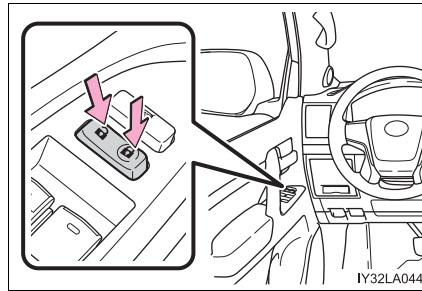

Use the same procedure to cancel the function.

Function	Shift lever position	Door lock switch position
Shift position linked door locking function	P	🔒
Shift position linked door unlocking function		🗝️
Speed linked door locking function	N	🔒
Driver's door linked door unlocking function		🗝️



When the setting or canceling operation is complete, all the doors are locked and then unlocked.

3



Operation of each component

■ **Changing the door unlock function setting**

It is possible to set which doors the entry function unlocks using the wireless remote control.

- 1 Turn the engine switch off.
- 2 When the indicator light on the key surface is not on, press and hold  or  for approximately 5 seconds while pressing and holding  .

The setting changes each time an operation is performed, as shown below. (When changing the setting continuously, release the buttons, wait for at least 5 seconds, and repeat step 2.)

Multi-information display	Unlocking function	Beep
	Holding the driver's door handle unlocks only the driver's door.	Exterior: Beeps 3 times Interior: Pings once
	Holding a passenger's door handle unlocks all the doors.	
	Holding a door handle unlocks all the doors.	Exterior: Beeps twice Interior: Pings once

To prevent unintended triggering of the alarm, unlock the doors using the wireless remote control and open and close a door once after the settings have been changed. (If a door is not opened within 60 seconds after  is pressed, the doors will be locked again and the alarm will automatically be set.)

In a case that the alarm is triggered, immediately stop the alarm. (→P. 76)

■ Impact detection door lock release system

In the event that the vehicle is subject to a strong impact, all the doors are unlocked. Depending on the force of the impact or the type of accident, however, the system may not operate.

■ Using the mechanical key

The doors can also be locked and unlocked with the mechanical key.
(→P. 540)

■ Conditions affecting the operation of the smart key system or wireless remote control

→P. 122

■ Customization

Settings (e.g. unlocking function using a key) can be changed.
(Customizable features: →P. 574)

**WARNING****■ To prevent an accident**

Observe the following precautions while driving the vehicle.

Failure to do so may result in a door opening and an occupant being thrown out of the vehicle, resulting in death or serious injury.

- Ensure that all doors are properly closed and locked.
- Do not pull the inside handle of the doors while driving.
Be especially careful for the front doors, as the doors may be opened even if the inside lock buttons are in locked position.
- Set the rear door child-protector locks when children are seated in the rear seats.

Back door

The back door can be locked/unlocked and opened by the following procedures.

Locking and unlocking the back door

◆ Smart key system

Carry the electronic key to enable this function.

- ① Locks all the doors
Check that the door is securely locked.
- ② Unlocks all the doors
The doors cannot be unlocked for 3 seconds after the doors are locked.

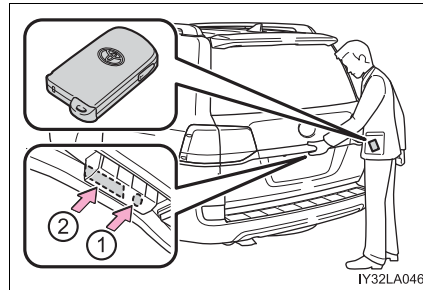

◆ Wireless remote control

→P. 106

◆ Door lock switches

→P. 108

Opening the back door from the outside

- 1 Raise the back door while pressing up the back door opener switch.

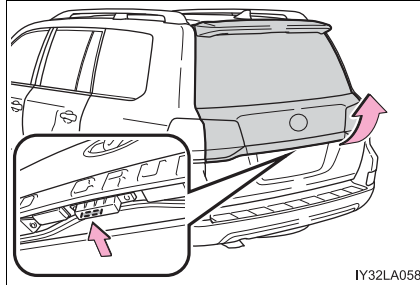

- 2 Pull the handle.

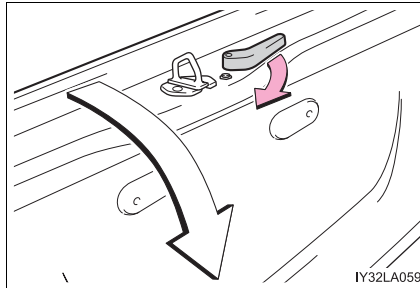
**When closing the back door**

- Make sure that the lower side of the back door is closed before closing the upper side of the back door.
- Lower the back door using the back door handle, and make sure to push the back door down from the outside to close it.

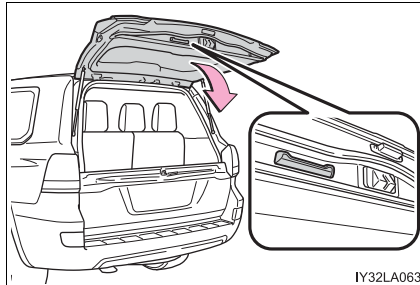

3

Operation of each component

Rear step bumper

The rear step bumper is for rear end protection and easier step-up loading.

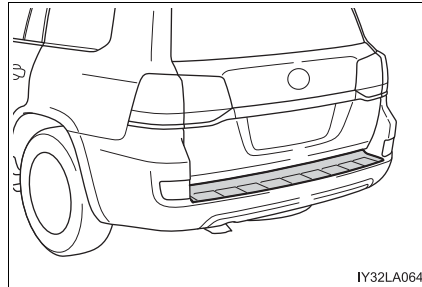

■ If the back door opener is inoperative

The back door can be operated from the inside.

- 1 Remove the cover on the back door trim.
Use a cloth to prevent scratches.

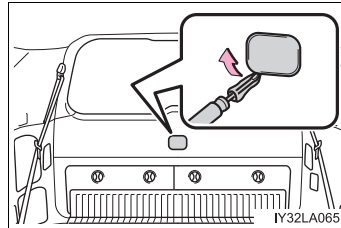

- 2 Remove the screw and cover.

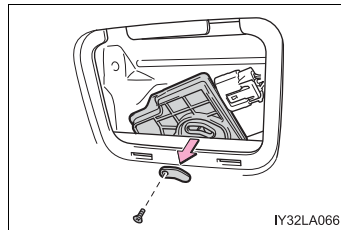

- 3 Push the lever for the back door motor, open the back door.

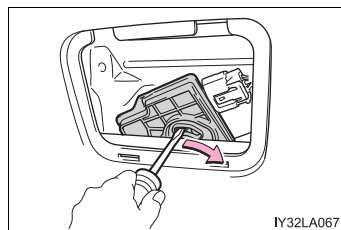

 **WARNING****■ While driving**

- Keep the back door closed while driving.
If the back door is left open, it may hit near-by objects while driving or luggage may be unexpectedly thrown out, causing an accident.
In addition, exhaust gases may enter the vehicle, causing death or a serious health hazard. Make sure to close the back door before driving.
- Before driving the vehicle, make sure that the back door is fully closed. If the back door is not fully closed, it may open unexpectedly while driving, causing an accident.
- Never let anyone sit in the luggage compartment. In the event of sudden braking, sudden swerving or a collision, they are susceptible to death or serious injury.

■ When children are in the vehicle

Observe the following precautions.

Failure to do so may result in death or serious injury.

- Do not allow children to play in the luggage compartment.
If a child is accidentally locked in the luggage compartment, they could have heat exhaustion or other injuries.
- Do not allow a child to open or close the back door.
Doing so may cause the back door to move unexpectedly, or cause the child's hands, head, or neck to be caught by the closing back door.

⚠ WARNING**■ Operating the back door**

Observe the following precautions.

Failure to do so may cause parts of the body to be caught, resulting in death or serious injury.

- Remove any heavy loads, such as snow and ice, from the back door before opening it. Failure to do so may cause the back door suddenly shut again after it is opened.
- When opening or closing the back door, thoroughly check to make sure the surrounding area is safe.
- If anyone is in the vicinity, make sure they are safe and let them know that the back door is about to open or close.
- Use caution when opening or closing the back door in windy weather as it may move abruptly in strong wind.
- The back door may suddenly shut if it is not opened fully. It is more difficult to open or close the back door on an incline than on a level surface, so beware of the back door unexpectedly opening or closing by itself. Make sure that the back door is fully open and secure before using the luggage compartment.

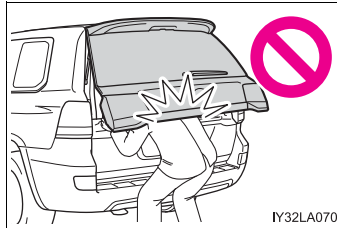

⚠ WARNING

- When closing the back door, take extra care to prevent your fingers etc. from being caught. Also pay attention to your personal belongings such as bags and ties.
- When closing the back door, make sure to press it lightly on its outer surface. If the back door handle is used to fully close the back door, it may result in hands or arms being caught.
- Do not pull on the back door damper stay to close the back door, and do not hang on the back door damper stay. Doing so may cause hands to be caught or the back door damper stay to break, causing an accident.
- If a bicycle carrier or similar heavy object is attached to the back door, it may suddenly shut again after being opened, causing someone's hands, head or neck to be caught and injured. When installing an accessory part to the back door, using a genuine Toyota part is recommended.

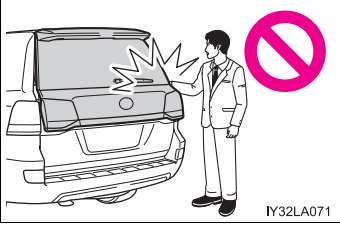

IY32LA071

⚠ NOTICE

■ **Back door damper stays**

The back door is equipped with damper stays that hold the back door in place. Observe the following precautions. Failure to do so may cause damage to the back door damper stay, resulting in malfunction.

- Do not attach any foreign objects, such as stickers, plastic sheets, or adhesives to the damper stay rod.
- Do not touch the damper stay rod with gloves or other fabric items.
- Do not attach any accessories other than genuine Toyota parts to the back door.
- Do not place your hand on the damper stay or apply lateral forces to it.

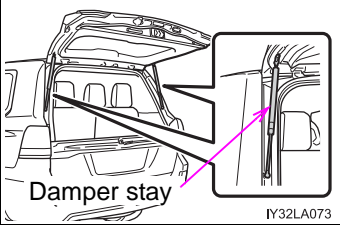

Damper stay

IY32LA073

Smart key system

The following operations can be performed simply by carrying the electronic key on your person, for example in your pocket. The driver should always carry the electronic key.

- Locks and unlocks the side doors (→P. 106)
- Locks and unlocks the back door (→P. 114)
- Starts the engine (→P. 193)

■ Antenna location

- ① Antennas outside the cabin
- ② Antennas inside the cabin
- ③ Antenna outside the luggage compartment

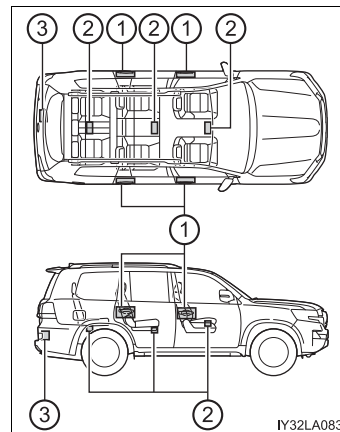

■ **Effective range (areas within which the electronic key is detected)**

- When locking or unlocking the doors

The system can be operated when the electronic key is within about 2.3 ft. (0.7 m) of either of the outside front door handle. (Only the doors detecting the key can be operated.)

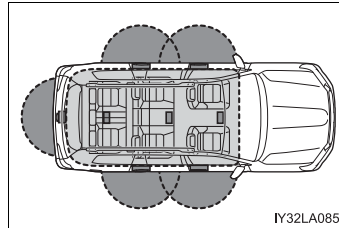

- When starting the engine or changing engine switch modes

The system can be operated when the electronic key is inside the vehicle.

■ **Alarms and warning indicators**

A combination of exterior and interior alarms as well as warning messages shown on the multi-information display are used to prevent theft of the vehicle and accidents resulting from erroneous operation. Take appropriate measures in response to any warning message on the multi-information display. The following table describes circumstances and correction procedures when only alarms are sounded.

Alarm	Situation	Correction procedure
Exterior alarm sounds once for 5 seconds	An attempt was made to lock the vehicle while a door is open	Close all of the doors and lock the doors again
Interior alarm pings continuously	The engine switch was turned to ACCESSORY mode while the driver's door was open (or the driver's door was opened while the engine switch was in ACCESSORY mode)	Turn the engine switch off and close the driver's door
	The engine switch was turned off while the driver's door was open	Close the driver's door



■ Battery-saving function

The battery-saving function will be activated in order to prevent the electronic key battery and the battery from being discharged while the vehicle is not in operation for a long time.

- In the following situations, the smart key system may take some time to unlock the doors.
 - The electronic key has been left in an area of approximately 6 ft. (2 m) of the outside of the vehicle for 10 minutes or longer.
 - The smart key system has not been used for 5 days or longer.
- If the smart key system has not been used for 14 days or longer, the doors cannot be unlocked at any doors except the driver's door. In this case, take hold of the driver's door handle, or use the wireless remote control or the mechanical key, to unlock the doors.

■ Electronic Key Battery-Saving Function

When battery-saving mode is set, battery depletion is minimized by stopping the electronic key from receiving radio waves.

Press  twice while pressing and holding . Confirm that the electronic key indicator flashes 4 times.

While the battery-saving mode is set, the smart key system cannot be used. To cancel the function, press any of the electronic key buttons.

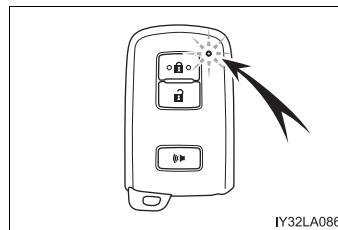

■ Conditions affecting operation

The smart key system uses weak radio waves. In the following situations, the communication between the electronic key and the vehicle may be affected, preventing the smart key system, wireless remote control and engine immobilizer system from operating properly.

(Ways of coping: →P. 540)

- When the electronic key battery is depleted
- Near a TV tower, electric power plant, gas station, radio station, large display, airport or other facility that generates strong radio waves or electrical noise
- When the electronic key is in contact with, or is covered by the following metallic objects
 - Cards to which aluminum foil is attached
 - Cigarette boxes that have aluminum foil inside
 - Metallic wallets or bags
 - Coins
 - Hand warmers made of metal
 - Media such as CDs and DVDs
- When other wireless keys (that emit radio waves) are being used nearby

- When carrying the electronic key together with the following devices that emit radio waves
 - When carrying a portable radio, cellular phone, cordless phone or other wireless communication device
 - Another vehicle's electronic key or a wireless key that emits radio waves
 - Personal computers or personal digital assistants (PDAs)
 - Digital audio players
 - Portable game systems
- If window tint with a metallic content or metallic objects are attached to the rear window
- When the electronic key is placed near a battery charger or electronic devices

■ **Note for the entry function**

- Even when the electronic key is within the effective range (detection areas), the system may not operate properly in the following cases:
 - The electronic key is too close to the window or outside door handle, near the ground, or in a high place when the doors are locked or unlocked.
 - The electronic key is on the instrument panel or floor, or in the door pockets or glove box when the engine is started or engine switch modes are changed.
- Do not leave the electronic key on top of the instrument panel or near the door pockets when exiting the vehicle. Depending on the radio wave reception conditions, it may be detected by the antenna outside the cabin and the doors will become lockable from the outside, possibly trapping the electronic key inside the vehicle.
- As long as the electronic key is within the effective range, the doors may be locked or unlocked by anyone. However, only the doors detecting the electronic key can be used to unlock the vehicle.
- Even if the electronic key is not inside the vehicle, it may be possible to start the engine if the electronic key is near the window.
- The doors may unlock or lock if a large amount of water splashes on the door handle, such as in the rain or in a car wash, when the electronic key is within the effective range. (The doors will automatically be locked after approximately 60 seconds if the doors are not opened and closed.)
- Touching the door lock or unlock sensor while wearing gloves may prevent lock or unlock operation.
- If the wireless remote control is used to lock the doors when the electronic key is near the vehicle, there is a possibility that the door may not be unlocked by the entry function. (Use the wireless remote control to unlock the doors.)
- When the lock operation is performed using the lock sensor, recognition signals will be shown up to two consecutive times. After this, no recognition signals will be given.

- If the door handle becomes wet while the electronic key is within the effective range, the door may lock and unlock repeatedly. In this case, follow the following correction procedures to wash the vehicle.
 - Place the electronic key in a location 6 ft. (2 m) or more away from the vehicle. (Take care to ensure that the key is not stolen.)
 - Set electronic key to battery-saving mode to disable the smart key system. (→P. 122)
- If the electronic key is inside the vehicle and a door handle becomes wet during a car wash, a message may be shown on the multi-information display and a buzzer will sound outside the vehicle. To turn off the alarm, lock all the doors.
- The lock sensor may not work properly if it comes into contact with ice, snow, mud, etc. Clean the lock sensor and attempt to operate it again, or use the lock sensor on the lower part of the door handle.
- If there is another electronic key in the detection area, it may take slightly longer to unlock the doors after the door handle is gripped or back door unlock switch is pressed.
- A sudden approach to the effective range or door handle may prevent the doors from being unlocked. In this case, return the door handle to the original position and check that the doors unlock before pulling the door handle again.

■ **When the vehicle is not driven for extended periods**

- To prevent theft of the vehicle, do not leave the electronic key within 6 ft. (2 m) of the vehicle.
- The smart key system can be deactivated in advance. (→P. 574)

■ **To operate the system properly**

Make sure to carry the electronic key when operating the system. Do not get the electronic key too close to the vehicle when operating the system from the outside of the vehicle.

Depending on the position and holding condition of the electronic key, the key may not be detected correctly and the system may not operate properly. (The alarm may go off accidentally, or the door lock prevention function may not operate.)

■ If the smart key system does not operate properly

- Locking and unlocking the doors: Use the mechanical key. (→P. 540)
- Starting the engine: →P. 541

■ Customization

Settings (e. g. smart key system) can be changed.
(Customizable features: →P. 574)

■ Certification for the smart key system

- ▶ For vehicles sold in the U.S.A., Hawaii, Guam, Saipan and Puerto Rico

FCC ID: HYQ23AAP
FCC ID: HYQ14FBA

NOTE:

This device complies with part 15 of the FCC Rules. Operation is subject to the following two conditions: (1) This device may not cause harmful interference, and (2) this device must accept any interference received, including interference that may cause undesired operation.

FCC WARNING:

Changes or modifications not expressly approved by the party responsible for compliance could void the user's authority to operate the equipment.

FCC ID: NI4TMLF12-1

This device complies with part 15 of the FCC Rules. Operation is subject to the following two conditions: (1) This device may not cause harmful interference; and (2) This device must accept any interference received, including interference that may cause undesired operation.

Changes or modifications not expressly approved by the party responsible for compliance could void the user's authority to operate the equipment.

 **WARNING****■ Caution regarding interference with electronic devices**

- People with implantable cardiac pacemakers, cardiac resynchronization therapy-pacemakers or implantable cardioverter defibrillators should keep away from the smart key system antennas. (→P. 120)

The radio waves may affect the operation of such devices. If necessary, the entry function can be disabled. Ask your Toyota dealer for details, such as the frequency of radio waves and timing of the emitted radio waves. Then, consult your doctor to see if you should disable the entry function.

- Users of any electrical medical device other than implantable cardiac pacemakers, cardiac resynchronization therapy-pacemakers or implantable cardioverter defibrillators should consult the manufacturer of the device for information about its operation under the influence of radio waves.

Radio waves could have unexpected effects on the operation of such medical devices.

Ask your Toyota dealer for details on disabling the entry function.

Front seats

Adjustment procedure

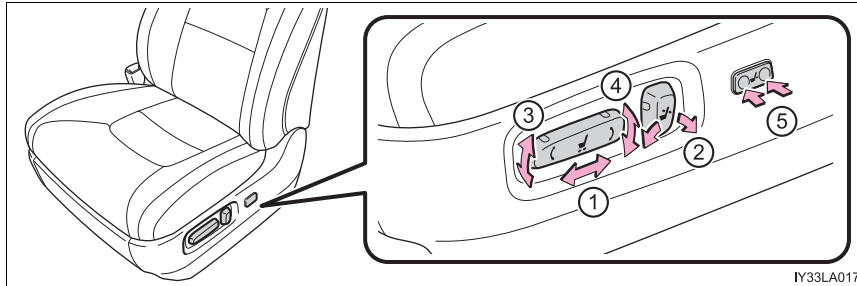

IY33LA017

- ① Seat position control switch
- ② Seatback angle control switch
- ③ Seat cushion (front) angle control switch
- ④ Vertical height control switch
- ⑤ Lumber support control switch (driver's side only)

Active head restraints

When the occupant's lower back presses against the seatback during a rear-end collision, the head restraint moves slightly forward and upward to help reduce the risk of whiplash on the seat occupant.

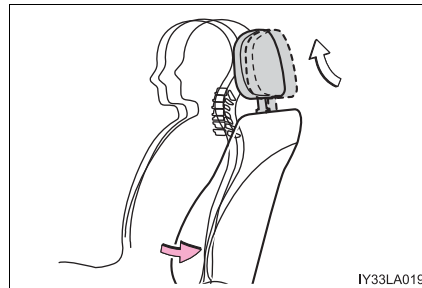

IY33LA019

3

Operation of each component

Active head restraints

Even small forces applied to the seatback may cause the head restraint to move. Pushing up a locked head restraint forcibly may appear the head restraint inner structure. These do not indicate problems.

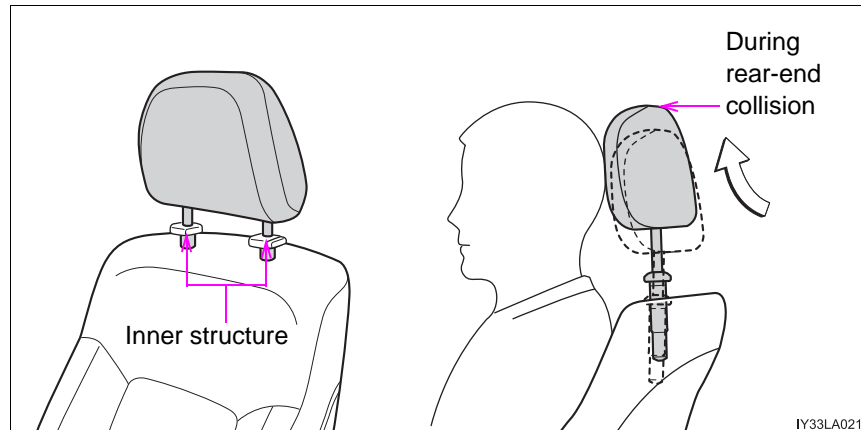
**⚠ WARNING****When adjusting the seat position**

- Take care when adjusting the seat position to ensure that other passengers are not injured by the moving seat.
- Do not put your hands under the seat or near the moving parts to avoid injury.
Fingers or hands may become jammed in the seat mechanism.

Seat adjustment

To reduce the risk of sliding under the lap belt during a collision, do not recline the seat more than necessary.

If the seat is too reclined, the lap belt may slide past the hips and apply restraint forces directly to the abdomen, or your neck may contact the shoulder belt, increasing the risk of death or serious injury in the event of an accident.

Adjustments should not be made while driving as the seat may unexpectedly move and cause the driver to lose control of the vehicle.

Rear seats

Adjustment procedure

► Second seats

- ① Seatback angle adjustment lever
- ② Seat position adjustment lever

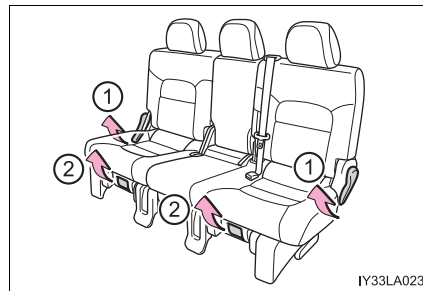

► Third seats

- ① Seatback angle adjustment lever

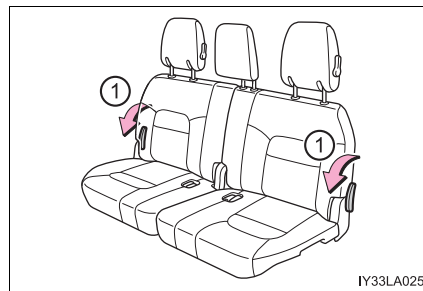

3

Operation of each component

Tumbling the second seats and third seat entry

For easy access to the third seat, perform 1 in “Tumbling the second seats”. (→P. 131)

■ Before tumbling the second seats

- 1 Stow the seat belt buckles and lower the head restraints to the lowest position.

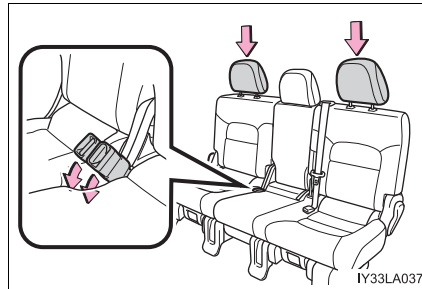

- 2 Pass the outer seat belts through the seat belt hangers and secure the seat belt plates.

This prevents the shoulder belt from being damaged.

Make sure that the seat belts are removed from the hangers before using them.

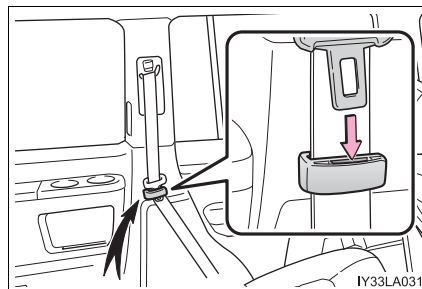

- 3 Vehicles with rear seat entertainment system: Install the display cover for the rear seat entertainment system.

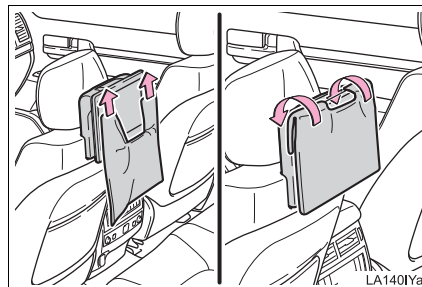

■ Tumbling the second seats

- 1 Fold down the seatback while pulling the seatback angle adjustment lever, and swing the whole seat up and forward.

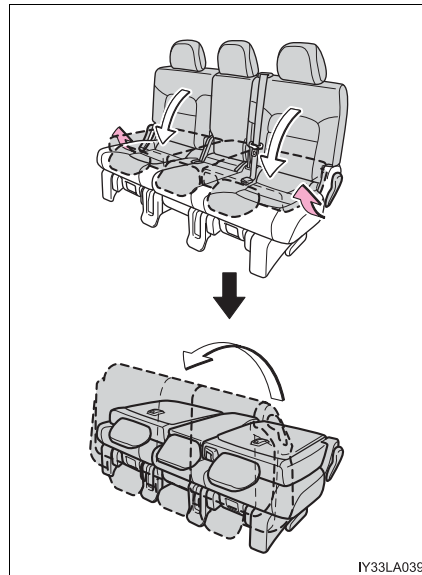

- 2 Hook the holding strap to the assist grip and secure the seat by pulling its free end.

When returning the second seat to its original position, stow the holding strap.

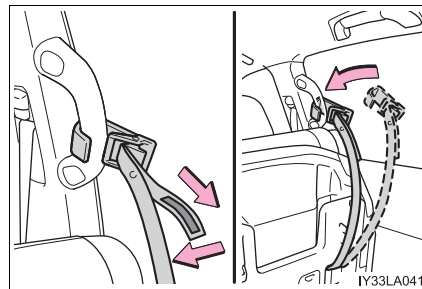

- 3 Remove the seat hook covers from the back of the seat cushion, and install them on the seat hooks.

When returning the second seat to its original position, remove the seat hook covers from the floor and install them in the back of the seat cushion.

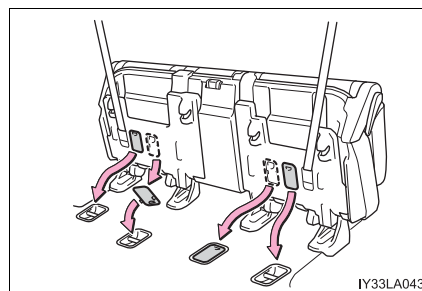

3

Operation of each component

Folding up the third seats

■ Before folding up the third seats

- 1 Stow the seat belts buckles.

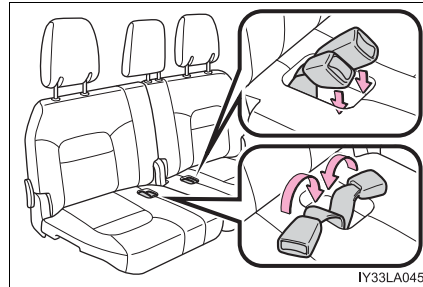

- 2 Stow the center head restraint in the seatback. (→P. 142)

- 3 Pass the outer seat belts through the seat belt hangers and secure the seat belt plates.

This prevents the shoulder belt from being damaged.

Make sure that the seat belts are removed from the hangers before using them.

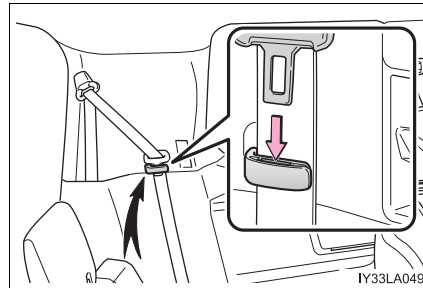

- 4 Stow the center seat belt tabs in the cover set in the roof. (→P. 31)

■ Folding up the third seats

- 1 Fold down the head restraints while pulling the head restraint angle lever.

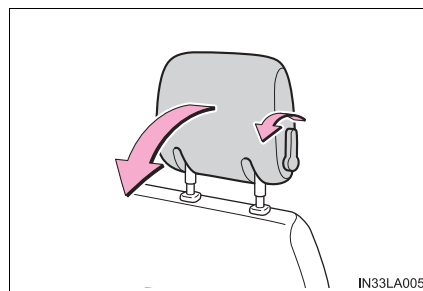

- 2 Push the seatback angle levers and fold the third seat-backs.

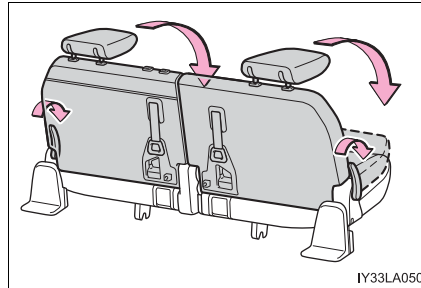

- 3 Pull the seat leg lock release levers.

The seat will rise, and the seat-back striker will also automatically sit up.

Before raising, make sure that the handle on the rear of the seatback is secure.

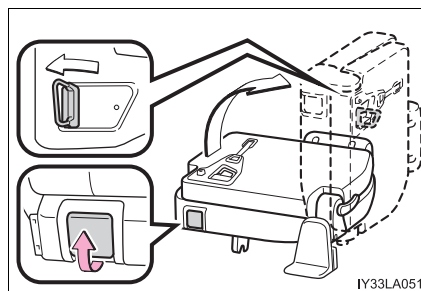

- 4 Secure the seats by the strikers.

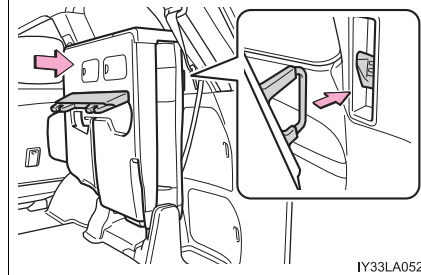

- 5 Remove the seat hook covers from the back of the seat cushion, and install them on the seat hooks.

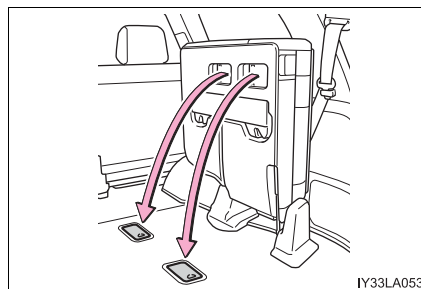

■ **Returning the third seats**

- 1 Remove the seat hook covers from the floor and install them into the back of the seat cushion.

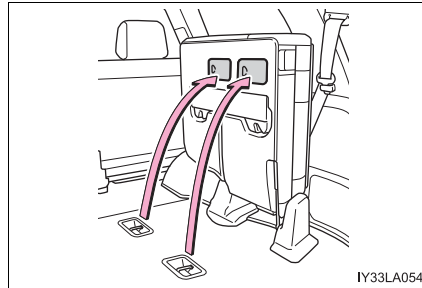

- 2 Unlock the seats by pulling the stowed seat lock release levers and lower the seats to its original position.

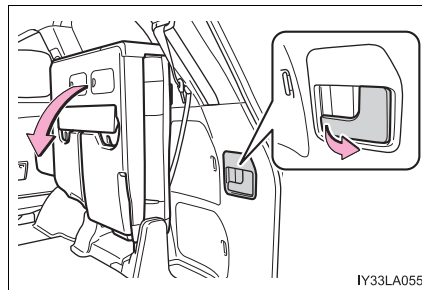

- 3 Secure the seats by the strikers.

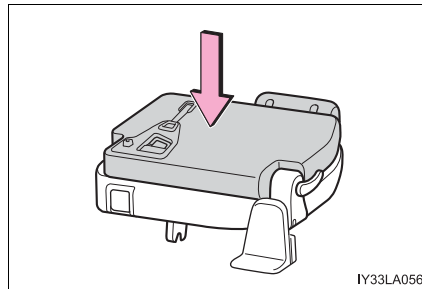

- 4 Pull the handle and raise the seatbacks.
Fix the handle securely in its original position after use.

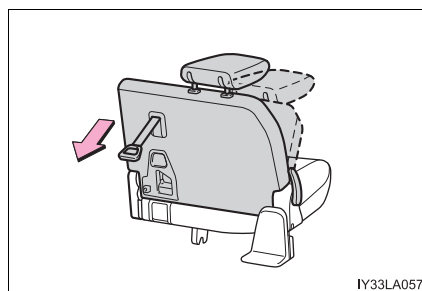

- 5 Raise the head restraints.

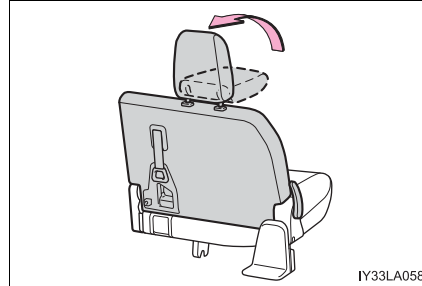

⚠ WARNING

■ **Seat adjustment**

To reduce the risk of sliding under the lap belt during a collision, do not recline the seat more than necessary.

If the seat is too reclined, the lap belt may slide past the hips and apply restraint forces directly to the abdomen, or your neck may contact the shoulder belt, increasing the risk of death or serious injury in the event of an accident.

Adjustments should not be made while driving as the seat may unexpectedly move and cause the driver to lose control of the vehicle.

■ **When the seatback is folded**

- Do not sit on or place anything on the seatback while driving.
- Be sure to install the seat hook covers on the seat hooks, or you may get burned when they become hot.

■ **When returning the seatbacks to their original position**

Observe the following precautions. Failure to do so may result in death or serious injury.

- Be careful not to get your hands or feet pinched in the seat.
- Make sure the seats are securely locked. Failure to do so will prevent the seat belt from operating properly.
- Check that the seat belts are not twisted or caught under the seat.
- Arrange the seat belts in the proper positions for ready use.

■ **Avoiding damage to seat components**

Do not hang or attach anything on the seatback striker.

⚠ NOTICE

■ **Before tumbling, folding up the seats**

The seat belts and buckles must be stowed.

■ **After returning the third seat**

Make sure that the handle on the rear of the seatback has been secured.

Driving position memory

This feature automatically adjusts the driver's seats, steering wheel and outside rear view mirrors to make entering and exiting the vehicle easier or to suit your preferences.

Driving position memory

Your preferred driving position (the position of the driver's seat, steering wheel and outside rear view mirrors) can be recorded and recalled by pressing a button.

Three different driving positions can be recorded into memory.

■ Recording procedure

- 1 Check that the shift lever is in P.
- 2 Turn the engine switch to IGNITION ON mode.
- 3 Adjust the driver's seat, steering wheel, and outside rear view mirrors to the desired positions.
- 4 While pressing the "SET" button, or within 3 seconds after the "SET" button is pressed, press button "1", "2" or "3" until the buzzer sounds.

If the selected button has already been preset, the previously recorded position will be overwritten.

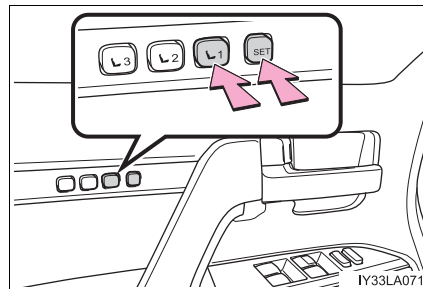

■ Recall procedure

- 1 Check that the shift lever is in P.
- 2 Turn the engine switch to IGNITION ON mode.
- 3 Press one of the buttons for the driving position you want to recall until the buzzer sounds.

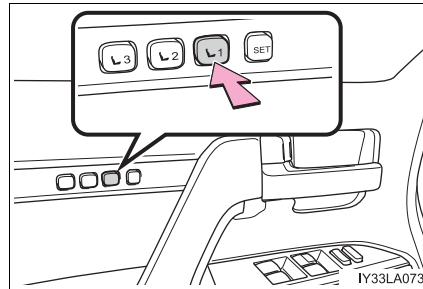

■ To stop the position recall operation part-way through

Perform any of the following:

- Press the “SET” button.
- Press button “1”, “2” or “3”.
- Operate any of the seat adjustment switches (only cancels seat position recall).
- Operate the tilt and telescopic steering control switch (only cancels steering wheel position recall).

■ Seat position that can be memorized (→P. 127)

The adjusted positions other than the position adjusted by lumbar support switch can be recorded.

■ Operating the driving position memory after turning the engine switch off

Recorded seat positions can be activated up to 180 seconds after the driver's door is opened and another 60 seconds after it is closed again.

■ In order to correctly use the driving position memory function

If a seat position is already in the furthest possible position and the seat is operated in the same direction, the recorded position may be slightly different when it is recalled.

Memory recall function

Each electronic key can be registered to recall your preferred driving position.

■ Registering procedure

Record your driving position to button “1”, “2” or “3” before performing the following:

Carry only the key you want to register, and then close the driver’s door.

If 2 or more keys are in the vehicle, the driving position cannot be recorded properly.

- 1 Check that the shift lever is in P.
- 2 Turn the engine switch to IGNITION ON mode.
- 3 Recall the driving position that you want to record.

- 4 While pressing the recalled button, press and hold the door lock switch (either lock or unlock) until the buzzer sounds.

If the button could not be registered, the buzzer sounds continuously for approximately 3 seconds.

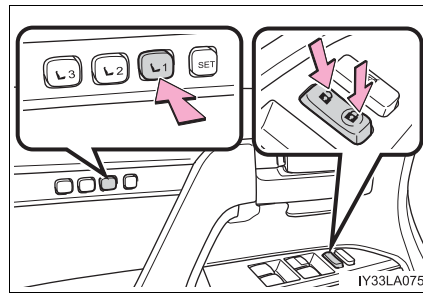

■ Recall procedure

Carry the electronic key that has been registered to the driving position, and then unlock and open the driver’s door using the smart key system or wireless remote control.

The driving position will move to the recorded position.

If the driving position is in a position that has already been recorded, the seat and outside rear view mirrors will not move.

■ Cancellation procedure

Carry only the key you want to cancel and then close the driver's door.

If 2 or more keys are in the vehicle, the driving position cannot be canceled properly.

- 1 Turn the engine switch to IGNITION ON mode.
- 2 While pressing the "SET" button, press and hold the door lock switch (either lock or unlock) until the buzzer sounds twice.

If the button could not be canceled, the buzzer sounds continuously for approximately 3 seconds.

■ Recalling the driving position using the memory recall function

- Different driving positions can be registered for each electronic key. Therefore, the driving position that is recalled may be different depending on the key being carried.
- If a door other than the driver's door is unlocked with the smart key system, the driving position cannot be recalled. In this case, press the driving position button which has been set.

■ Customization

The unlock door settings of the memory recall function can be customized. (Customizable features: →P. 574)

WARNING

■ Seat adjustment caution

Take care during seat adjustment so that the seat does not strike the rear passenger or squeeze your body against the steering wheel.

Head restraints

Head restraints are provided for all seats.

Front seats

Vertical adjustment

- ① Up
Pull the head restraints up.
- ② Down
Push the head restraint down while pushing the lock release button.

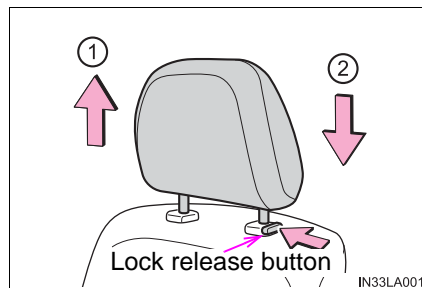

Angle adjustment (if equipped)

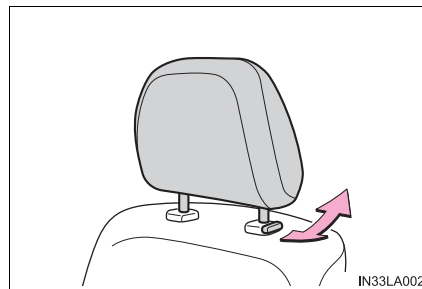

Second seats

- ① Up
Pull the head restraints up.
- ② Down
Press and hold the lock release button when lowering the head restraint.

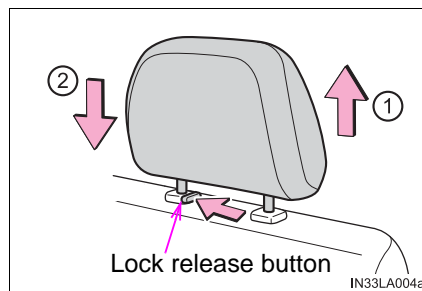

Third outboard seats

To fold the head restraints, pull the head restraint angle lever

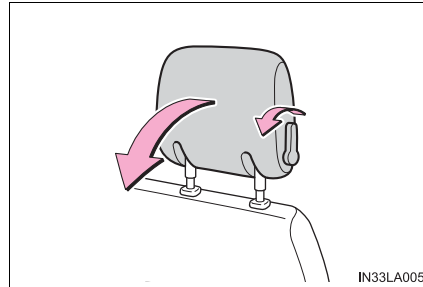

Adjusting the height of the head restraints

Make sure that the head restraints are adjusted so that the center of the head restraint is closest to the top of your ears.

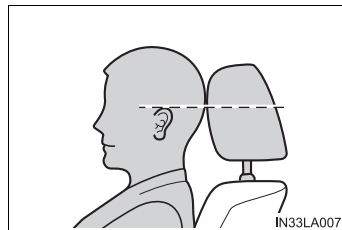

Removing the head restraints

► Front seats

- 1 Push a flathead screwdriver into the slot. The slot is located on the right side of the right head restraint anchor.

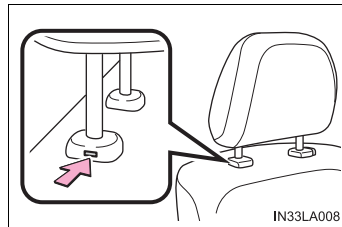

- 2 While pressing in the flathead screwdriver, pull up the head restraint.

► Second seats

Pull the head restraint up while pressing the lock release button.

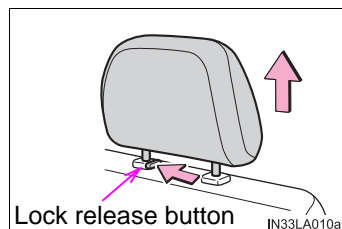

3

Operation of each component

► Third center seat

Pull the head restraint up while pressing the lock release button.

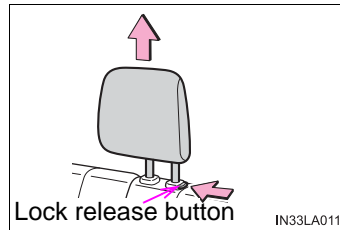

► Third outboard seats

- 1 Push a flathead screwdriver into the slot. The slot is located on the left side of the left head restraint anchor.

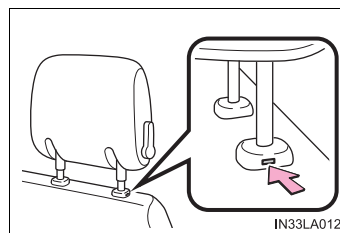

- 2 While pressing in the flathead screwdriver, pull up the head restraint.

■ Installing the head restraints

- 1 Align the head restraint with the installation holes.
- 2 Push down the head restraint to the lock position.

■ When not using the third center seat head restraint

Open the zipper on the back of the third seat and stow the head restraint inside.

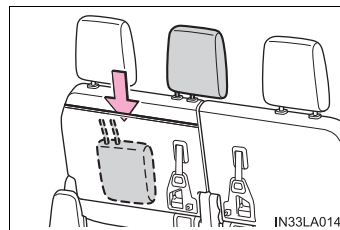

⚠ WARNING

■ Head restraint precautions

Observe the following precautions regarding the head restraints. Failure to do so may result in death or serious injury.

- Use the head restraints designed for each respective seat.
- Adjust the head restraints to the correct position at all times.
- After adjusting the head restraints, push down on them and make sure they are locked in position.
- Do not drive with the head restraints removed.

Steering wheel

Adjustment procedure

- ① Up
- ② Down
- ③ Toward the driver
- ④ Away from the driver

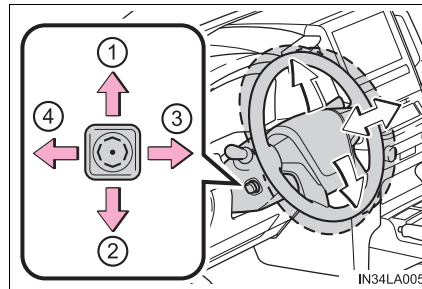

Auto tilt away

When the engine switch is off, the steering wheel returns to its stowed position by moving up and away to enable easier driver entry and exit.

Switching to ACCESSORY or IGNITION ON mode will return the steering wheel to the original position.

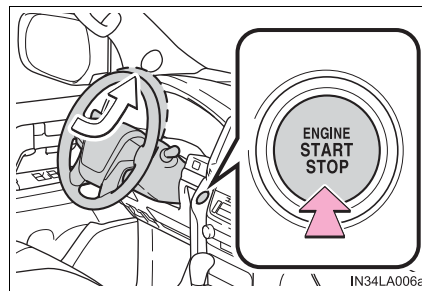

Horn

To sound the horn, press on or close to the  mark.

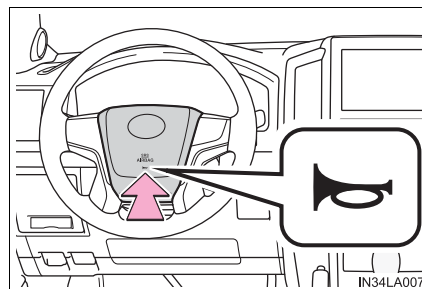

3

Operation of each component

■ **The steering wheel can be adjusted when**

The engine switch is in ACCESSORY or IGNITION ON mode*.

*: If the driver's seat belt is fastened, the steering wheel can be adjusted regardless of engine switch mode.

■ **Automatic adjustment of the steering position**

A desired steering position can be entered to memory and recalled automatically by the driving position memory system. (→P. 136)

 **WARNING**

Do not adjust the steering wheel while driving.
Doing so may cause the driver to mishandle the vehicle and cause an accident, resulting in death or serious injury.

Inside rear view mirror

The rear view mirror's position can be adjusted to enable sufficient confirmation of the rear view in accordance with the driver's seating posture.

Adjusting the height of rear view mirror

The height of the rear view mirror can be adjusted to suit your driving posture.

Adjust the height of the rear view mirror by moving it up and down.

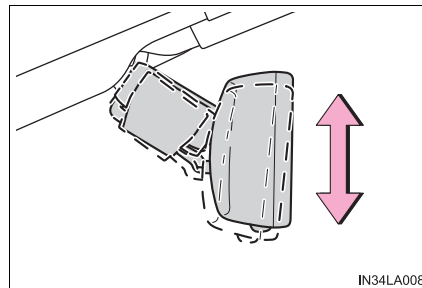

Anti-glare function

Responding to the level of brightness of the headlights of vehicles behind, the reflected light is automatically reduced.

Changing automatic anti-glare function mode

ON/OFF

When the automatic anti-glare function is in ON mode, the indicator illuminates.

The function will be set to ON mode each time the engine switch is turned to IGNITION ON mode.

Pressing the button turns the function to OFF mode. (The indicator also turns off.)

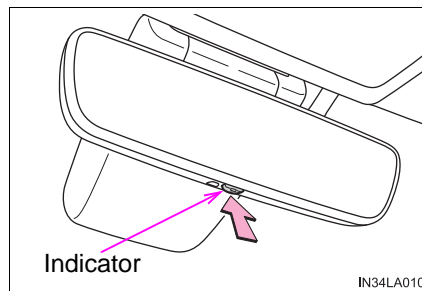

■ **To prevent sensor error**

To ensure that the sensors operate properly, do not touch or cover them.

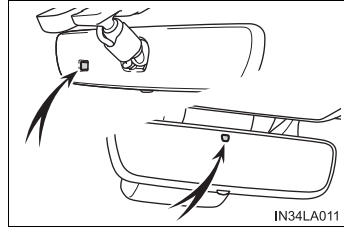

⚠ WARNING

Do not adjust the position of the mirror while driving.
Doing so may lead to mishandling of the vehicle and cause an accident,
resulting in death or serious injury.

Outside rear view mirrors

Adjustment procedure

- 1 To select a mirror to adjust, press the switch.

- ① Left
- ② Right

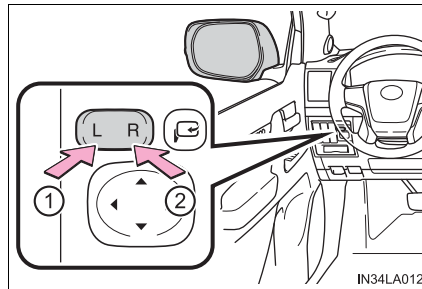

- 2 To adjust the mirror, press the switch.

- ① Up
- ② Right
- ③ Down
- ④ Left

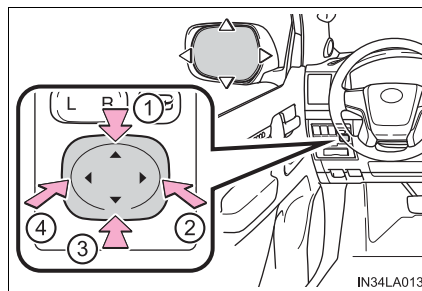

Folding and extending the mirrors

Press the switch

Pressing again will extend the mirrors.

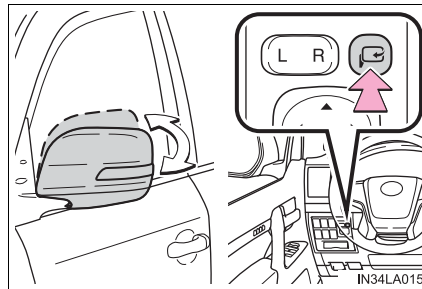

3

Operation of each component

Linked mirror function when reversing

When the mirror select switch is in the L or R position, the outside rear view mirrors will automatically angle downwards when the vehicle is reversing in order to give a better view of the ground.

To disable this function, move the mirror select switch to the neutral position (between L and R).

■ Adjusting the mirror angle when the vehicle is reversing

With the shift lever in R, adjust the mirror angle at a desired position. The adjusted angle will be memorized and the mirror will automatically tilt to the memorized angle whenever the shift lever is shifted to R from next time.

The memorized downward tilt position of the mirror is linked to the normal position (angle adjusted with the shift lever in other than R). Therefore, if the normal position is changed after adjustment, the tilt position will also change.

When the normal position is changed, readjust the angle in reversing.

■ Mirror angle can be adjusted when

The engine switch is in ACCESSORY or IGNITION ON mode.

■ When the mirrors are fogged up

The outside rear view mirrors can be cleared using the mirror defoggers. Turn on the rear window defogger to turn on the outside rear view mirror defoggers. (→P. 380)

■ Auto anti-glare function

When the anti-glare inside rear view mirror is set to auto mode, the outside rear view mirrors will activate in conjunction with the anti-glare inside rear view mirror to reduce reflected light. (→P. 145)

■ Automatic adjustment of the mirror angle

A desired mirror face angle can be entered to memory and adjusted with the touch of a button. (→P. 138)

 WARNING**■ Important points while driving**

Observe the following precautions while driving.

Failing to do so may result in loss of control of the vehicle and cause an accident, resulting in death or serious injury.

- Do not adjust the mirrors while driving.
- Do not drive with the mirrors folded.
- Both the driver and passenger side mirrors must be extended and properly adjusted before driving.

■ When a mirror is moving

To avoid personal injury and mirror malfunction, be careful not to get your hand caught by the moving mirror.

■ When the mirror defoggers are operating

Do not touch the rear view mirror surfaces, as they can become very hot and burn you.

 NOTICE**■ If ice should jam the mirror**

Do not operate the control or scrape the mirror face. Use a spray de-icer to free the mirror.

Power windows

Opening and closing procedures

The power windows can be opened and closed using the switches.

Operating the switch moves the windows as follows:

- ① Closing
- ② One-touch closing*
- ③ Opening
- ④ One-touch opening*

*: To stop the window partway, operate the switch in the opposite direction.

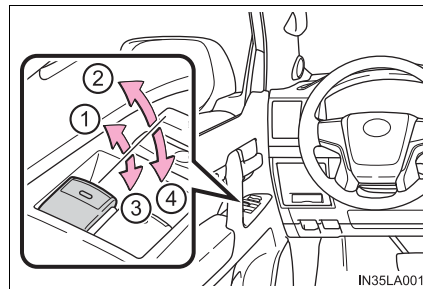

Window lock switch

Press the switch down to lock the passenger window switches.

The indicator will come on.

Use this switch to prevent children from accidentally opening or closing a passenger window.

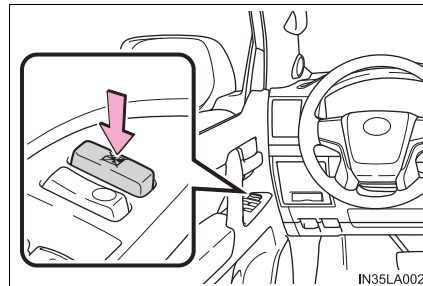

■ The power windows can be operated when

The engine switch is in IGNITION ON mode.

■ Operating the power windows after turning the engine off

The power windows can be operated for approximately 45 seconds even after the engine switch is turned to ACCESSORY mode or turned off. They cannot, however, be operated once either front door is opened.

■ Jam protection function

If an object becomes jammed between the window and the window frame while the window is closing, window movement is stopped and the window is opened slightly.

■ Catch protection function

If an object becomes caught between the door and window while the window is opening, window movement is stopped.

■ When the window cannot be opened or closed

When the jam protection function or catch protection function operates unusually and the door window cannot be opened or closed, perform the following operations with the power window switch of that door.

- Stop the vehicle. With the engine switch in IGNITION ON mode, within 4 seconds of the jam protection function or catch protection function activating, continuously operate the power window switch in the one-touch closing direction or one-touch opening direction so that the door window can be opened and closed.
- If the door window cannot be opened and closed even when performing the above operations, perform the following procedure for function initialization.
 - 1 Turn the engine switch to IGNITION ON mode.
 - 2 Pull and hold the power window switch in the one-touch closing direction and completely close the door window.
 - 3 Release the power window switch for a moment and then resume pulling and holding the switch in the one-touch closing direction for approximately 4 seconds.
 - 4 Press and hold the power window switch in the one-touch opening direction. After the door window is completely opened, continue holding the switch for an additional 1 second or more.
 - 5 Pull and hold the power window switch in the one-touch closing direction again. After the door window is completely closed, continue holding the switch for a further 1 second or more.

If you release the switch while the window is moving, start again from the beginning.

If the window reverses and cannot be fully closed or opened, have the vehicle inspected by your Toyota dealer.

■ Door lock linked window operation

- The power windows can be opened and closed using the mechanical key.* (→P. 540)
- The power windows can be opened using the wireless remote control.* (→P. 106)

*: The settings must be customized at your Toyota dealer.

■ Power windows open warning buzzer

The buzzer sounds and a message is shown on the multi-information display in the instrument cluster when the engine switch is turned off and the driver's door is opened with the power windows open.

■ Customization

Settings (e.g. linked door lock operation) can be changed.
(Customizable features: →P. 574)

⚠ WARNING

Observe the following precautions.
Failing to do so may result in death or serious injury.

■ Closing the windows

- The driver is responsible for all the power window operations, including the operation for the passengers. In order to prevent accidental operation, especially by a child, do not let a child operate the power windows. It is possible for children and other passengers to have body parts caught in the power window. Also, when riding with a child, it is recommended to use the window lock switch. (→P. 150)
- Check to make sure that all passengers do not have any part of their body in a position where it could be caught when a window is being operated.
- When using the wireless remote control or mechanical key and operating the power windows, operate the power window after checking to make sure that there is no possibility of any passenger having any of their body parts caught in the window. Also, do not let a child operate window by the wireless remote control or mechanical key. It is possible for children and other passengers to get caught in the power window.
- When exiting the vehicle, turn the engine switch off, carry the key and exit the vehicle along with the child. There may be accidental operation, due to mischief, etc., that may possibly lead to an accident.

■ Jam protection function

- Never use any part of your body to intentionally activate the jam protection function.
- The jam protection function may not work if something gets caught just before the window fully closes.

■ Catch protection function

- Never use hands, arms, clothing, etc., to intentionally activate the catch protection function.
- The catch protection function may not operate if something gets caught just before the window is fully opened. Be careful not to get hands, arms, clothing, etc., caught in the window.

Moon roof

Use the overhead switches to open and close the moon roof and tilt it up and down.

Opening and closing

- ① Opens the moon roof*
The moon roof stops slightly before the fully open position to reduce wind noise.
Press the switch again to fully open the moon roof.
- ② Closes the moon roof*
*: Lightly press either end of the moon roof switch to stop the moon roof partway.

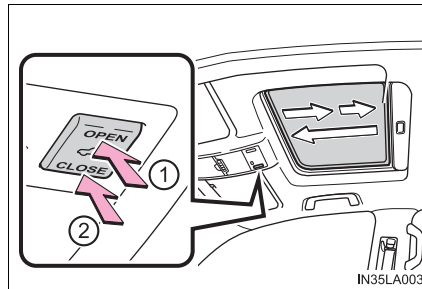

Tilting up and down

- ① Tilts the moon roof up*
 - ② Tilts the moon roof down*
- *: Lightly press either end of the moon roof switch to stop the moon roof partway.

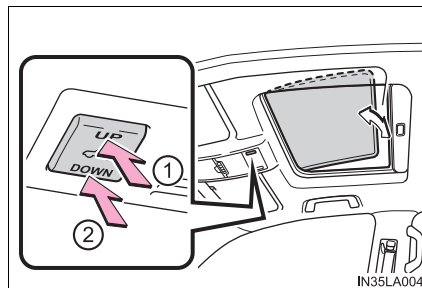

■ The moon roof can be operated when

The engine switch is in IGNITION ON mode.

■ Operating the moon roof after turning the engine off

The moon roof can be operated for approximately 45 seconds after the engine switch is turned to ACCESSORY mode or turned off. It cannot, however, be operated once either front door is opened.

■ Jam protection function

If an object is detected between the moon roof and the frame while the moon roof is closing or tilting down, travel is stopped and the moon roof opens slightly.

■ If the moon roof cannot be closed automatically

Keep the switch depressed.

■ Sunshade

The sunshade can be opened and closed manually. However, the sunshade will open automatically when the moon roof is opened.

■ Door lock linked moon roof operation

- The moon roof can be opened and closed using the mechanical key.*
(→P. 540)
- The moon roof can be opened using the wireless remote control.*
(→P. 106)

*: The settings must be customized at your Toyota dealer.

■ When the moon roof does not close normally

Perform the following procedure:

- If the moon roof closes but then re-opens slightly

- 1 Stop the vehicle.
- 2 Press and hold the "CLOSE" switch.*1
The moon roof will close, re-open and pause for approximately 10 seconds.*2 Then it will close again, tilt up and pause for approximately 1 second. Finally, it will tilt down, open and close.
- 3 Check to make sure that the moon roof is completely closed and then release the switch.

● If the moon roof tilts down but then tilts back up

- 1 Stop the vehicle.
- 2 Press and hold the “UP” switch.*¹ until the moon roof moves into the tilt up position and stops.
- 3 Release the “UP” switch once and then press and hold the “UP” switch again.*¹

The moon roof will pause for approximately 10 seconds in the tilt up position.*² Then it will adjust slightly and pause for approximately 1 second. Finally, it will tilt down, open and close.

- 4 Check to make sure that the moon roof is completely closed and then release the switch.

*¹: If the switch is released at the incorrect time, the procedure will have to be performed again from the beginning.

*²: If the switch is released after the above mentioned 10 second pause, automatic operation will be disabled. In that case, press and hold the “CLOSE” or “UP” switch, and the moon roof will tilt up and pause for approximately 1 second. Then it will tilt down, open and close. Check to make sure that the moon roof is completely closed and then release the switch.

If the moon roof does not fully close even after performing the above procedure correctly, have the vehicle inspected by your Toyota dealer.

■ **Moon roof open reminder function**

The buzzer sounds and message is shown on the multi-information display in the instrument panel when the engine switch is turned off and the driver's door is opened with the moon roof open.

■ **Customization**

Settings (e.g. linked door lock operation) can be changed.
(Customizable features: →P. 574)

⚠ WARNING

Observe the following precautions.

Failing to do so may cause death or serious injury.

■ Opening the moon roof

- Do not allow any passengers to put their hands or heads outside the vehicle while it is moving.
- Do not sit on top of the moon roof.

■ Closing the moon roof

- The driver is responsible for moon roof opening and closing operations. In order to prevent accidental operation, especially by a child, do not let a child operate the moon roof. It is possible for children and other passengers to have body parts caught in the moon roof.
- Check to make sure that all passengers do not have any part of their bodies in a position where it could be caught when the moon roof is being operated.
- When using the wireless remote control or mechanical key and operating the moon roof, operate the moon roof after checking to make sure that there is no possibility of any passenger having any of their body parts caught in the moon roof. Also, do not let a child operate moon roof by the wireless remote control or mechanical key. It is possible for children and other passengers to get caught in the moon roof.
- When exiting the vehicle, turn the engine switch off, carry the key and exit the vehicle along with the child. There may be accidental operation, due to mischief, etc., that may possibly lead to an accident.

■ Jam protection function

- Never use any part of your body to intentionally activate the jam protection function.
- The jam protection function may not work if something gets caught just before the moon roof fully closes.

- | | |
|--|--|
| <p>4-1. Before driving</p> <ul style="list-style-type: none"> Driving the vehicle..... 160 Cargo and luggage 169 Vehicle load limits 175 Trailer towing..... 176 Dinghy towing 192 <p>4-2. Driving procedures</p> <ul style="list-style-type: none"> Engine (ignition) switch 193 Automatic transmission 199 Turn signal lever..... 203 Parking brake 204 <p>4-3. Operating the lights and wipers</p> <ul style="list-style-type: none"> Headlight switch 205 Automatic High Beam 209 Fog light switch 214 Windshield wipers and washer 215 Rear window wiper and washer 219 Headlight cleaner switch 221 <p>4-4. Refueling</p> <ul style="list-style-type: none"> Opening the fuel tank cap 222 | <p>4-5. Using the driving support systems</p> <ul style="list-style-type: none"> Toyota Safety Sense P 226 PCS (Pre-Collision system)..... 233 LDA (Lane Departure Alert) 248 Dynamic radar cruise control 257 Cruise control 269 Intuitive parking assist..... 272 Four-wheel drive system... 280 Crawl Control (with Turn Assist function) 284 Multi-terrain Select 289 Multi-terrain Monitor 293 BSM (Blind Spot Monitor) 343 <ul style="list-style-type: none"> • BSM function 347 • RCTA function 351 Driving assist systems 357 <p>4-6. Driving tips</p> <ul style="list-style-type: none"> Off-road precautions 364 Winter driving tips 369 |
|--|--|

Driving the vehicle

The following procedures should be observed to ensure safe driving:

Starting the engine

→P. 193

Driving

- 1 With the brake pedal depressed, shift the shift lever to D. (→P. 199)
- 2 Release the parking brake. (→P. 204)
- 3 Gradually release the brake pedal and gently depress the accelerator pedal to accelerate the vehicle.

Stopping

- 1 With the shift lever in D, depress the brake pedal.
- 2 If necessary, set the parking brake.
If the vehicle is to be stopped for an extended period of time, shift the shift lever to P or N. (→P. 199)

Parking the vehicle

- 1 With the shift lever in D, depress the brake pedal.
- 2 Shift the shift lever to P. (→P. 199)
- 3 Set the parking brake. (→P. 204)
- 4 Press the engine switch to stop the engine.
- 5 Lock the door, making sure that you have the key on your person.
If parking on a hill, block the wheels as needed.

Starting off on a steep uphill

- 1 Make sure that the parking brake is set and shift the shift lever to D.
- 2 Gently depress the accelerator pedal.
- 3 Release the parking brake.

■ When starting off on an uphill

Hill-start assist control is activated. (→P. 357)

■ Driving in the rain

- Drive carefully when it is raining, because visibility will be reduced, the windows may become fogged-up, and the road will be slippery.
- Drive carefully when it starts to rain, because the road surface will be especially slippery.
- Refrain from high speeds when driving on an expressway in the rain, because there may be a layer of water between the tires and the road surface, preventing the steering and brakes from operating properly.

■ Engine speed while driving

In the following conditions, the engine speed may become high while driving. This is due to automatic up-shifting control or down-shifting implementation to meet driving conditions. It does not indicate sudden acceleration.

- The vehicle is judged to be driving uphill or downhill
- When the accelerator pedal is released
- When the brake pedal is depressed

■ Restraining engine output (Brake Override System)

- When the accelerator and brake pedals are depressed at the same time, the engine output may be restrained.
- A warning message is displayed on the multi-information display while the system is operating. If a warning message is shown on the multi-information display, read the message and follow the instructions.

■ Breaking in your new Toyota

To extend the life of the vehicle, observing the following precautions is recommended:

- For the first 200 miles (300 km):
Avoid sudden stops.
- For the first 500 miles (800 km):
Do not tow a trailer.
- For the first 600 miles (1000 km):
 - Do not drive at extremely high speeds.
 - Avoid sudden acceleration.
 - Do not drive continuously in the low gears.
 - Do not drive at a constant speed for extended periods.

■ **Drum-in-disc type parking brake system**

Your vehicle has a drum-in-disc type parking brake system. This type of brake system needs bedding-down of the brake shoes periodically or whenever the parking brake shoes and/or drum are replaced. Have your Toyota dealer, perform the bedding-down operation.

■ **Operating your vehicle in a foreign country**

Comply with the relevant vehicle registration laws and confirm the availability of the correct fuel. (→P. 560)

■ **When turning off the engine**

Emission system operating sounds may continue for a short time after the engine is turned off. This is not a malfunction, and helps to ensure optimal performance of the emission system.

⚠ WARNING

Observe the following precautions.
Failure to do so may result in death or serious injury.

■ When starting the vehicle

Always keep your foot on the brake pedal while stopped with the engine running. This prevents the vehicle from creeping.

■ When driving the vehicle

- Do not drive if you are unfamiliar with the location of the brake and accelerator pedals to avoid depressing the wrong pedal.
 - Accidentally depressing the accelerator pedal instead of the brake pedal will result in sudden acceleration that may lead to an accident.
 - When backing up, you may twist your body around, leading to a difficulty in operating the pedals. Make sure to operate the pedals properly.
 - Make sure to keep a correct driving posture even when moving the vehicle only slightly. This allows you to depress the brake and accelerator pedals properly.
 - Depress the brake pedal using your right foot. Depressing the brake pedal using your left foot may delay response in an emergency, resulting in an accident.
- Do not drive the vehicle over or stop the vehicle near flammable materials. The exhaust system and exhaust gases can be extremely hot. These hot parts may cause a fire if there is any flammable material nearby.
- During normal driving, do not turn off the engine. Turning the engine off while driving will not cause loss of steering or braking control, but the power assist to these systems will be lost. This will make it more difficult to steer and brake, so you should pull over and stop the vehicle as soon as it is safe to do so.
However, in the event of an emergency, such as if it becomes impossible to stop the vehicle in the normal way: →P. 501
- Use engine braking (downshift) to maintain a safe speed when driving down a steep hill.
Using the brakes continuously may cause the brakes to overheat and lose effectiveness. (→P. 199)
- Do not adjust the positions of the steering wheel, the seat, or the inside or outside rear view mirrors while driving.
Doing so may result in a loss of vehicle control.
- Always check that all passengers' arms, heads or other parts of their body are not outside the vehicle.
- Do not drive in excess of the speed limit. Even if the legal speed limit permits it, do not drive over 85 mph (140 km/h) unless your vehicle has high-speed capability tires. Driving over 85 mph (140 km/h) may result in tire failure, loss of control and possible injury. Be sure to consult a tire dealer to determine whether the tires on your vehicle are high-speed capability tires or not before driving at such speeds.

 **WARNING**

Observe the following precautions.

Failure to do so may result in death or serious injury.

■ **When driving on slippery road surfaces**

- Sudden braking, acceleration and steering may cause tire slippage and reduce your ability to control the vehicle.
- Sudden acceleration, engine braking due to shifting, or changes in engine speed could cause the vehicle to skid.
- After driving through a puddle, lightly depress the brake pedal to make sure that the brakes are functioning properly. Wet brake pads may prevent the brakes from functioning properly. If the brakes on only one side are wet and not functioning properly, steering control may be affected.

■ **When shifting the shift lever**

- Do not let the vehicle roll backwards while the shift lever is in a driving position, or roll forward while the shift lever is in R.
Doing so may cause the engine to stall or lead to poor brake and steering performance, resulting in an accident or damage to the vehicle.
- Do not shift the shift lever to P while the vehicle is moving.
Doing so can damage the transmission and may result in a loss of vehicle control.
- Do not shift the shift lever to R while the vehicle is moving forward.
Doing so can damage the transmission and may result in a loss of vehicle control.
- Do not shift the shift lever to a driving position while the vehicle is moving backward.
Doing so can damage the transmission and may result in a loss of vehicle control.
- Moving the shift lever to N while the vehicle is moving will disengage the engine from the transmission. Engine braking is not available when N is selected.
- Be careful not to shift the shift lever with the accelerator pedal depressed.
Shifting the shift lever to a gear other than P or N may lead to unexpected rapid acceleration of the vehicle that may cause an accident.

■ **If you hear a squealing or scraping noise (brake pad wear limit indicators)**

Have the brake pads checked and replaced by your Toyota dealer as soon as possible.

Rotor damage may result if the pads are not replaced when needed.

It is dangerous to drive the vehicle when the wear limits of the brake pads and/or those of the brake discs are exceeded.

 **WARNING**

Observe the following precautions.
Failure to do so may result in death or serious injury.

■ When the vehicle is stopped

- Do not race the engine.
If the vehicle is in any gear other than P or N, the vehicle may accelerate suddenly and unexpectedly, causing an accident.
- In order to prevent accidents due to the vehicle rolling away, always keep depressing the brake pedal while the engine is running, and apply the parking brake as necessary.
- If the vehicle is stopped on an incline, in order to prevent accidents caused by the vehicle rolling forward or backward, always depress the brake pedal and securely apply the parking brake as needed.
- Avoid revving or racing the engine. Running the engine at high speed while the vehicle is stopped may cause the exhaust system to overheat, which could result in a fire if combustible material is nearby.

■ When the vehicle is parked

- Do not leave glasses, cigarette lighters, spray cans, or soft drink cans in the vehicle when it is in the sun.
Doing so may result in the following:
 - Gas may leak from a cigarette lighter or spray can, and may lead to a fire.
 - The temperature inside the vehicle may cause the plastic lenses and plastic material of glasses to deform or crack.
 - Soft drink cans may fracture, causing the contents to spray over the interior of the vehicle, and may also cause a short circuit in the vehicle's electrical components.
- Do not leave cigarette lighters in the vehicle. If a cigarette lighter is in a place such as the glove box or on the floor, it may be lit accidentally when luggage is loaded or the seat is adjusted, causing a fire.
- Do not attach adhesive discs to the windshield or windows. Do not place containers such as air fresheners on the instrument panel or dashboard. Adhesive discs or containers may act as lenses, causing a fire in the vehicle.
- Do not leave a door or window open if the curved glass is coated with a metallized film such as a silver-colored one. Reflected sunlight may cause the glass to act as a lens, causing a fire.

 **WARNING**

Observe the following precautions.

Failure to do so may result in death or serious injury.

■ **When the vehicle is parked**

- Always apply the parking brake, shift the shift lever to P, stop the engine and lock the vehicle.

Do not leave the vehicle unattended while the engine is running.

- If the shift lever is moved before the low speed four-wheel drive indicator turns on/off, the transfer mode may not be shifted completely. The transfer mode disengages both the front and rear driveshafts from the powertrain and allows the vehicle to move regardless of the shift position. (At this time, the indicator blinks and the buzzer sounds.)

Therefore, the vehicle is free to roll even if the automatic transmission is in P. You or someone else could be seriously injured. You must complete the shifting of the transfer mode. (→P. 280)

- Do not touch the exhaust pipes while the engine is running or immediately after turning the engine off.

Doing so may cause burns.

■ **When taking a nap in the vehicle**

Always turn the engine off. Otherwise, if you accidentally move the shift lever or depress the accelerator pedal, this could cause an accident or fire due to engine overheating. Additionally, if the vehicle is parked in a poorly ventilated area, exhaust gases may collect and enter the vehicle, leading to death or a serious health hazard.

■ **When braking**

- When the brakes are wet, drive more cautiously.

Braking distance increases when the brakes are wet, and this may cause one side of the vehicle to brake differently than the other side. Also, the parking brake may not securely hold the vehicle.

- If the power brake assist function does not operate, do not follow other vehicles closely and avoid hills or sharp turns that require braking. In this case, braking is still possible, but the brake pedal should be depressed more firmly than usual. Also, the braking distance will increase. Have your brakes fixed immediately.

- Do not pump the brake pedal if the engine stalls.

Each push on the brake pedal uses up the reserve for the power-assisted brakes.

- The brake system consists of 2 individual hydraulic systems: If one of the systems fails, the other will still operate. In this case, the brake pedal should be depressed more firmly than usual and the braking distance will increase.

Have your brakes fixed immediately.

⚠ WARNING

Observe the following precautions.
Failure to do so may result in death or serious injury.

■ If the vehicle becomes stuck

Do not spin the wheels excessively when any of the tires is up in the air, or the vehicle is stuck in sand, mud, etc. This may damage the driveline components or propel the vehicle forward or backward, causing an accident.

⚠ NOTICE**■ When driving the vehicle**

- Do not depress the accelerator and brake pedals at the same time during driving, as this may restrain the engine output.
- Do not use the accelerator pedal or depress the accelerator and brake pedals at the same time to hold the vehicle on a hill.

■ When parking the vehicle

Always shift the shift lever to P. Failure to do so may cause the vehicle to move or the vehicle may accelerate suddenly if the accelerator pedal is accidentally depressed.

■ Avoiding damage to vehicle parts

- Do not turn the steering wheel fully in either direction and hold it there for an extended period of time.
Doing so may damage the power steering pump.
- When driving over bumps in the road, drive as slowly as possible to avoid damaging the wheels, underside of the vehicle, etc.

■ If you get a flat tire while driving

A flat or damaged tire may cause the following situations. Hold the steering wheel firmly and gradually depress the brake pedal to slow down the vehicle.

- It may be difficult to control your vehicle.
- The vehicle will make abnormal sounds or vibrations.
- The vehicle will lean abnormally.

Information on what to do in case of a flat tire. (→P. 524)

 NOTICE

■ **When encountering flooded roads**

Do not drive on a road that has flooded after heavy rain etc. Doing so may cause the following serious damage to the vehicle:

- Engine stalling
- Short in electrical components
- Engine damage caused by water immersion

In the event that you drive on a flooded road and the vehicle is flooded, be sure to have your Toyota dealer check the following:

- Brake function
- Changes in quantity and quality of oil and fluid used for the engine, transmission, transfer, differentials, etc.
- Lubricant condition for the propeller shaft, bearings and suspension joints (where possible), and the function of all joints, bearings, etc.

Cargo and luggage

Take notice of the following information about storage precautions, cargo capacity and load:

Roof luggage carrier (if equipped)

- ① Roof rails
- ② Cross rails

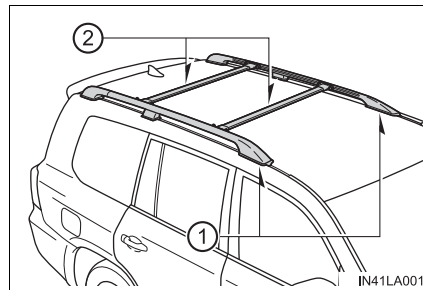

Adjusting the position of cross rails (if equipped)

- ① Turn the knobs counterclockwise to release the cross rails.

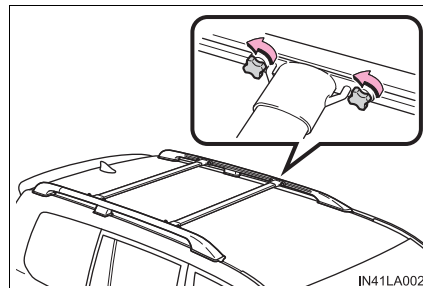

- ② Slide the cross rails to the appropriate position for loading luggage and turn the knobs clockwise to tighten the cross rails securely.

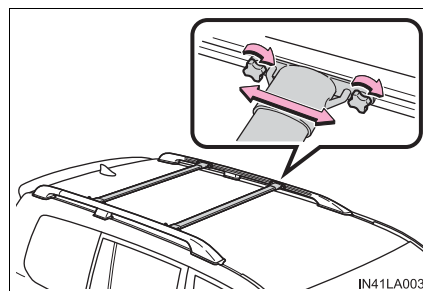

Capacity and distribution

Cargo capacity depends on the total weight of the occupants.

(Cargo capacity) = (Total load capacity) – (Total weight of occupants)

Steps for Determining Correct Load Limit —

- (1) Locate the statement “The combined weight of occupants and cargo should never exceed XXX kg or XXX lbs.” on your vehicle’s placard.
- (2) Determine the combined weight of the driver and passengers that will be riding in your vehicle.
- (3) Subtract the combined weight of the driver and passengers from XXX kg or XXX lbs.
- (4) The resulting figure equals the available amount of cargo and luggage load capacity.
For example, if the “XXX” amount equals 1400 lbs. and there will be five 150 lb passengers in your vehicle, the amount of available cargo and luggage load capacity is 650 lbs. (1400 – 750 (5 × 150) = 650 lbs.)
- (5) Determine the combined weight of luggage and cargo being loaded on the vehicle. That weight may not safely exceed the available cargo and luggage load capacity calculated in Step 4.
- (6) If your vehicle will be towing a trailer, load from your trailer will be transferred to your vehicle. Consult this manual to determine how this reduces the available cargo and luggage load capacity of your vehicle. (→P. 175)

Calculation formula for your vehicle

- ① Cargo capacity
- ② Total load capacity (vehicle capacity weight) (→P. 552)

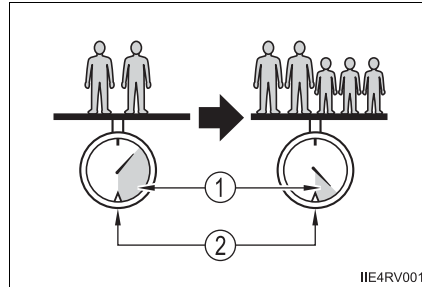

When 2 people with the combined weight of A lb. (kg) are riding in your vehicle, which has a total load capacity (vehicle capacity weight) of B lb. (kg), the available amount of cargo and luggage load capacity will be C lb. (kg) as follows:

$$B^{*2} \text{ lb. (kg)} - A^{*1} \text{ lb. (kg)} = C^{*3} \text{ lb. (kg)}$$

*1: A = Weight of people

*2: B = Total load capacity

*3: C = Available cargo and luggage load

In this condition, if 3 more passengers with the combined weight of D lb. (kg) get on, the available cargo and luggage load will be reduced E lb. (kg) as follows:

$$C \text{ lb. (kg)} - D^{*4} \text{ lb. (kg)} = E^{*5} \text{ lb. (kg)}$$

*4: D = Additional weight of people

*5: E = Available cargo and luggage load

As shown in the example above, if the number of occupants increases, the cargo and luggage load will be reduced by an amount that equals the increased weight due to the additional occupants. In other words, if an increase in the number of occupants causes an excess of the total load capacity (combined weight of occupants plus cargo and luggage load), you must reduce the cargo and luggage on your vehicle.

 **WARNING****■ Things that must not be carried in the luggage compartment**

The following things may cause a fire if loaded in the luggage compartment:

- Receptacles containing gasoline
- Aerosol cans

■ Storage precautions

Observe the following precautions.

Failure to do so may prevent the pedals from being depressed properly, may block the driver's vision, or may result in items hitting the driver or passengers, possibly causing an accident.

- Stow cargo and luggage in the luggage compartment whenever possible.
- Do not stack cargo and luggage in the luggage compartment higher than the seatbacks.
- Do not place cargo or luggage in or on the following locations.
 - At the feet of the driver
 - On the front passenger or rear seats (when stacking items)
 - On the instrument panel
 - On the dashboard
 - On auxiliary box or tray that has no lid
- Secure all items in the occupant compartment.
- When you fold down the rear seats, long items should not be placed directly behind the front seats.
- Never allow anyone to ride in the luggage compartment. It is not designed for passengers. They should ride in their seats with their seat belts properly fastened. Otherwise, they are much more likely to suffer death or serious bodily injury, in the event of sudden braking, sudden swerving or an accident.

⚠ WARNING**■ Load and distribution**

- Do not exceed the maximum axle weight rating or the total vehicle weight rating.
- Even if the total load of occupant's weight and the cargo load is less than the total load capacity, do not apply the load unevenly. Improper loading may cause deterioration of steering or braking control which may cause death or serious injury.

■ Roof luggage carrier precautions (if equipped)

To use the roof rails as a roof luggage carrier, you must fit the roof rails with two or more genuine Toyota cross rails or their equivalent. Follow the manufacturer's instructions and precautions when installing the cross rails or their equivalent.

When you load cargo on the roof luggage carrier, observe the following:

- Place the cargo so that its weight is distributed evenly between the front and rear axles.
- If loading long or wide cargo, never exceed the vehicle overall length or width. (→P. 552)
- Before driving, make sure the cargo is securely fastened on the roof luggage carrier.
- Loading cargo on the roof luggage carrier will make the center of gravity of the vehicle higher. Avoid high speeds, sudden starts, sharp turns, sudden braking or abrupt maneuvers, otherwise it may result in loss of control or vehicle rollover due to failure to operate this vehicle correctly and result in death or serious injury.
- If driving for a long distance, on rough roads, or at high speeds, stop the vehicle now and then during the trip to make sure the cargo remains in its place.
- Do not exceed 154 lb. (70 kg) cargo weight on the roof luggage carrier.

■ Cross rail adjustment

Make sure the cross rails are locked securely by pushing forward and rearward them.

Failure to do so may cause an accident or serious injury in the event of emergency braking or a collision.

 NOTICE

■ **Cross rail adjustment**

Do not remove the cross rail stoppers, or the moon roof may be damaged when it is tilted.

■ **When loading cargo on the roof luggage carrier (if equipped)**

Be careful not to scratch the surface of the moon roof.

Vehicle load limits

Vehicle load limits include total load capacity, seating capacity, TWR (Trailer Weight Rating) and cargo capacity.

◆ **Total load capacity (vehicle capacity weight): →P. 552**

Total load capacity means the combined weight of occupants, cargo and luggage.

◆ **Seating capacity: 8 occupants (Front 2, Rear 6)**

Seating capacity means the maximum number of occupants whose estimated average weight is 150 lb. (68 kg) per person.

◆ **TWR (Trailer Weight Rating): →P. 180, 552**

TWR means the maximum gross trailer weight (trailer weight plus its cargo weight) that your vehicle is able to tow.

◆ **Cargo capacity**

Cargo capacity may increase or decrease depending on the weight and the number of occupants.

■ **Total load capacity and seating capacity**

These details are also described on the tire and loading information label. (→P. 472)

 **WARNING**

■ **Overloading the vehicle**

Do not overload the vehicle.

It may not only cause damage to the tires, but also degrade steering and braking ability, resulting in an accident.

Trailer towing

Your vehicle is designed primarily as a passenger-and-load-carrying vehicle. Towing a trailer can have an adverse impact on handling, performance, braking, durability, and fuel consumption. For your safety and the safety of others, you must not overload your vehicle or trailer. You must also ensure that you are using appropriate towing equipment, that the towing equipment has been installed correctly and used properly, and that you employ the requisite driving habits.

Vehicle-trailer stability and braking performance are affected by trailer stability, brake performance and setting, trailer brakes, the hitch and hitch systems (if equipped).

To tow a trailer safely, use extreme care and drive the vehicle in accordance with your trailer's characteristics and operating conditions.

Toyota warranties do not apply to damage or malfunction caused by towing a trailer for commercial purposes.

Contact your Toyota dealer for further information about additional requirements such as towing kits, etc.

Towing related terms

■ **GCWR (Gross Combination Weight Rating)**

The maximum allowable gross combination weight. The gross combination weight is the sum of the total vehicle weight (including the occupants, cargo and any optional equipment installed on the vehicle) and the weight of the trailer being towed (including the cargo in the trailer).

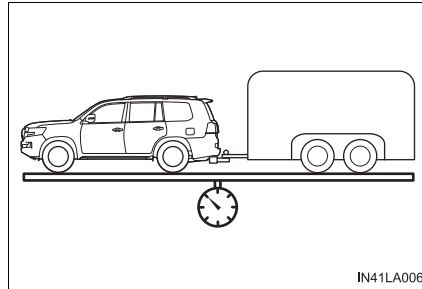

■ **GVWR (Gross Vehicle Weight Rating)**

The maximum allowable gross vehicle weight. The gross vehicle weight is the total weight of the vehicle. When towing a trailer, it is the sum of the vehicle weight (including the occupants, cargo and any optional equipment installed on the vehicle) and the tongue weight.

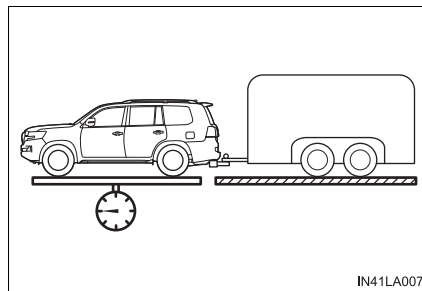

■ **GAWR (Gross Axle Weight Rating)**

The maximum allowable gross axle weight. The gross axle weight is the load placed on each axle (front and rear).

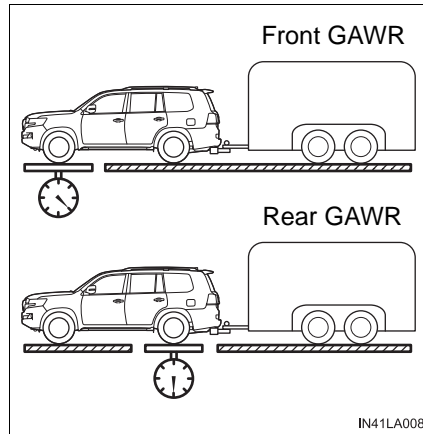

■ **TWR (Trailer Weight Rating)**

The maximum allowable gross trailer weight. The gross trailer weight is the sum of the trailer weight and the weight of the cargo in the trailer.

TWR is calculated assuming base vehicle with one driver, one front passenger, towing package (if available), hitch and hitch systems (if required).

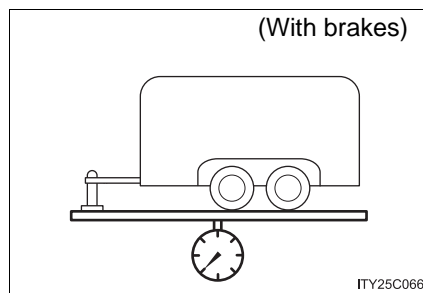

Additional optional equipment, passengers and cargo in the vehicle will reduce the trailer weight rating so as not to exceed GCWR, GVWR and GAWR.

If the gross trailer weight exceeds 3000 lb. (1360 kg), it is recommended to use a trailer with 2 or more axles.

■ **Unbraked TWR (Unbraked Trailer Weight Rating)**

The trailer weight rating for towing a trailer without a trailer service brake system.

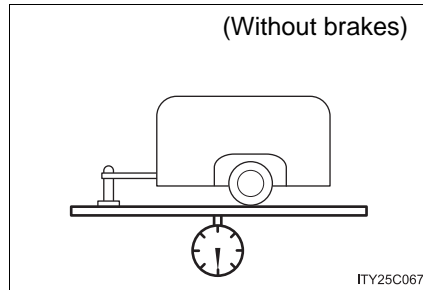

■ **Tongue Weight**

The load placed on the trailer hitch ball. (→P. 181)

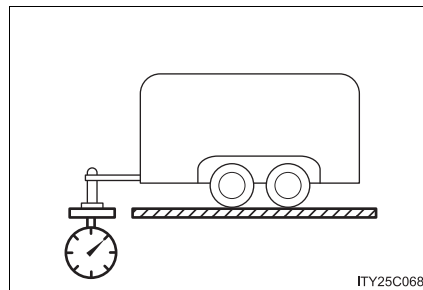

Weight limits

- The gross trailer weight must never exceed 8100 lb. (3670 kg).
- The gross combination weight must never exceed 14400 lb. (6532 kg).
- The gross vehicle weight must never exceed the GVWR indicated on the Certification Label.
- The gross axle weight on each axle must never exceed the GAWR indicated on the Certification Label.
- If the gross trailer weight is over the unbraked TWR, trailer service brakes are required.
- If the gross trailer weight is over 2000 lb. (907 kg), a sway control device with sufficient capacity is required.
- If the gross trailer weight is over 5000 lb. (2268 kg), a weight distributing hitch with sufficient capacity is required.

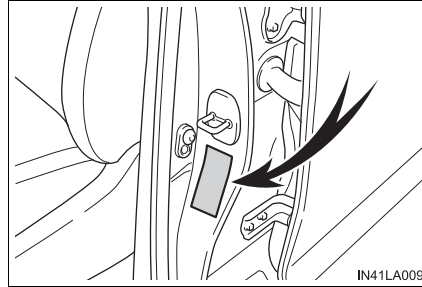

GCWR, TWR and Unbraked TWR

Confirm that the gross trailer weight, gross combination weight, gross vehicle weight, gross axle weight and tongue weight are all within the limits.

- **GCWR***
14400 lb. (6532 kg)
- **TWR***
8100 lb. (3670 kg)
- **Unbraked TWR***
1000 lb. (454 kg)

*: This model meets the tow-vehicle trailering requirement of SAE International per SAE J2807.

Trailer Tongue Weight

- A recommended tongue weight varies in accordance with the types of trailers or towing as described below.
- To ensure the recommended values shown below, the trailer must be loaded by referring to the following instructions.

- Tongue Weight

The gross trailer weight should be distributed so that the tongue weight is 9 % to 11 %. (Tongue weight/Gross trailer weight \times 100 = 9 % to 11 %)

- ① Gross trailer weight
- ② Tongue weight

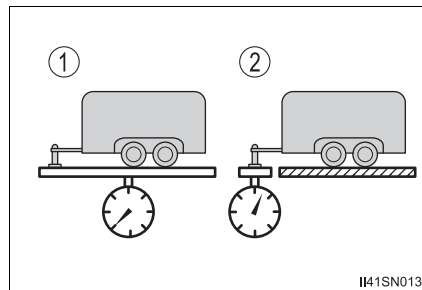

If using a weight distributing hitch when towing, return the front axle to the same weight as before the trailer connection.

If front axle weight cannot be measured directly, measure the front fender height above the front axle before connection. Adjust weight distributing hitch torque until front fender is returned to the same height as before connection.

The gross trailer weight, gross axle weight and tongue weight can be measured with platform scales found at a highway weighing station, building supply company, trucking company, junk yard, etc.

Hitch

Trailer hitch assemblies have different weight capacities. Toyota recommends the use of Toyota hitch/bracket for your vehicle. For details, contact your Toyota dealer.

- If you wish to install a trailer hitch, contact your Toyota dealer.
- Use only a hitch that conforms to the gross trailer weight requirement of your vehicle.
- Follow the directions supplied by the hitch manufacturer.
- Lubricate the hitch ball with a light coating of grease.
- Remove the trailer hitch whenever you are not towing a trailer. After removing the hitch, seal any mounting hole in the vehicle body to prevent entry of any substances into the vehicle.

Removing hitch cover

- 1 Remove the clip.

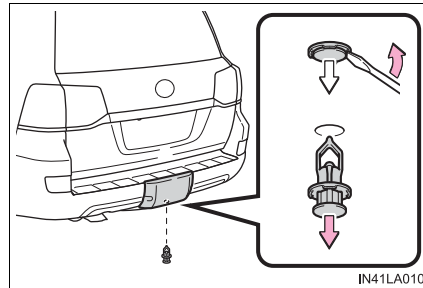

- 2 Grasp the lower edge of the hitch cover and raise the cover.
When reattaching the cover, reverse the steps listed.

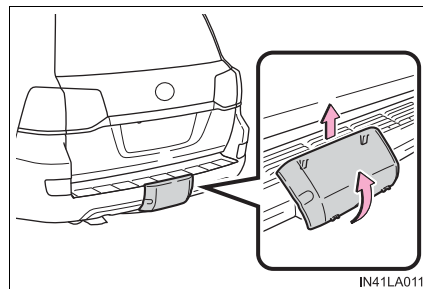

Selecting trailer ball

Use the correct trailer ball for your application.

- ① Trailer ball load rating
Matches or exceeds the gross trailer weight rating of the trailer.
- ② Ball diameter
Matches the size of the trailer coupler. Most couplers are stamped with the required trailer ball size.

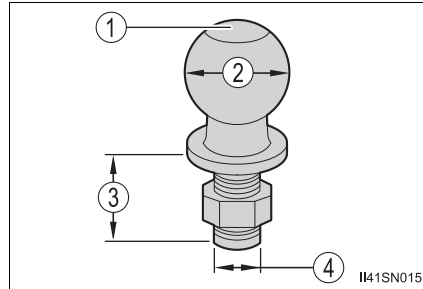

Trailer class	Typical trailer ball size
IV	2 5/16 in.
II and III	2 in.
I	1 7/8 in.

- ③ Shank length
Protrudes beyond the bottom of the lock washer and nut by at least 2 threads.
- ④ Shank diameter
Matches the ball mount hole diameter size.

4

Driving

Positions for towing hitch receiver

- ① Hitch receiver pin hole position:
45.3 in. (1151 mm)

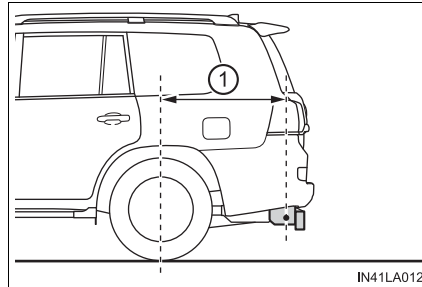

Connecting trailer lights

Use the wire harness stored in the rear end under the vehicle body. Please consult your dealer when installing trailer lights, as incorrect installation may cause damage to the vehicle's lights. Please take care to comply with your state's laws when installing trailer lights.

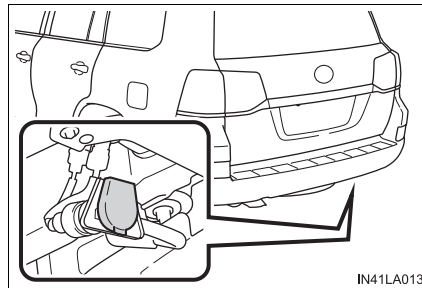

■ Service connector for towing brake controller

Your vehicle is equipped with a service connector for the trailer brake controller. Please consult your dealer when installing trailer brake systems to the vehicle.

Trailer towing tips

Your vehicle will handle differently when towing a trailer. Help to avoid an accident, death or serious injury, keep the following in mind when towing:

- Speed limits for towing a trailer vary by state or province. Do not exceed the posted towing speed limit.
- Toyota recommends that the vehicle-trailer speed limit is 65 mph (104 km/h) on a flat, straight, dry road. Do not exceed this limit, the posted towing speed limit or the speed limit for your trailer as set forth in your trailer owner's manual, whichever is lowest. Instability of the towing vehicle-trailer combination (trailer sway) increases as speed increases. Exceeding speed limits may cause loss of control.
- Before starting out, check the trailer lights, tires and the vehicle-trailer connections. Recheck after driving a short distance.
- Practice turning, stopping and reversing with the trailer attached in an area away from traffic until you become accustomed to the feel of the vehicle-trailer combination.
- Reversing with a trailer attached is difficult and requires practice. Grip the bottom of the steering wheel and move your hand to the left to move the trailer to the left. Move your hand to the right to move the trailer to the right. (This is generally opposite to reversing without a trailer attached.) Avoid sharp or prolonged turning. Have someone guide you when reversing to reduce the risk of an accident.
- As stopping distance is increased when towing a trailer, vehicle-to-vehicle distance should be increased. For each 10 mph (16 km/h) of speed, allow at least one vehicle and trailer length.
- Avoid sudden braking as you may skid, resulting in the trailer jack-knifing and loss of vehicle control. This is especially true on wet or slippery surfaces.

- Avoid jerky starts or sudden acceleration.
- Avoid jerky steering and sharp turns, and slow down before making a turn.
- Note that when making a turn, the trailer wheels will be closer than the vehicle wheels to the inside of the turn. Compensate by making a wider than normal turning radius.
- Slow down before making a turn, in crosswinds, on wet or slippery surfaces, etc.
Increasing vehicle speed can destabilize the trailer.
- Take care when passing other vehicles. Passing requires considerable distance. After passing a vehicle, do not forget the length of your trailer, and be sure you have plenty of room before changing lanes.
- To maintain engine braking efficiency and charging system performance when using engine braking, do not put the transmission in D.
If in the S mode, the transmission shift range position must be in 6 or lower. (→P. 199)
- Instability happens more frequently when descending steep or long downhill grades. Before descending, slow down and downshift. Do not make sudden downshifts while descending steep or long downhill grades.
- Avoid holding the brake pedal down too long or applying the brakes too frequently. This could cause the brakes to overheat and result in reduced braking efficiency.
- Due to the added load of the trailer, your vehicle's engine may overheat on hot days (at temperatures over 85°F [30°C]) when driving up a long or steep grade. If the engine coolant temperature gauge indicates overheating, immediately turn off the air conditioning (if in use), pull your vehicle off the road and stop in a safe spot.
(→P. 546)

- Always place wheel blocks under both the vehicle's and the trailer's wheels when parking. Apply the parking brake firmly, and put the transmission in P. Avoid parking on a slope, but if unavoidable, do so only after performing the following:
 - 1 Apply the brakes and keep them applied.
 - 2 Have someone place wheel blocks under both the vehicle's and trailer's wheels.
 - 3 When the wheel blocks are in place, release the brakes slowly until the blocks absorb the load.
 - 4 Apply the parking brake firmly.
 - 5 Shift into P and turn off the engine.
- When restarting after parking on a slope:
 - 1 With the transmission in P, start the engine. Be sure to keep the brake pedal pressed.
 - 2 Shift into a forward gear. If reversing, shift into R.
 - 3 Release the parking brake and brake pedal, and slowly pull or back away from the wheel blocks. Stop and apply the brakes.
 - 4 Have someone retrieve the blocks.

■ Matching trailer ball height to trailer coupler height

No matter which class of tow hitch applies, for a more safe trailer hookup, the trailer ball setup must be the proper height for the coupler on the trailer.

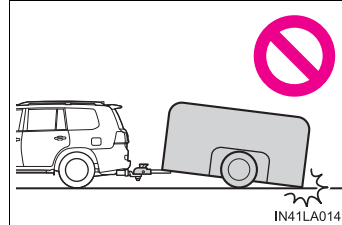

- ① Coupler
- ② Trailer ball

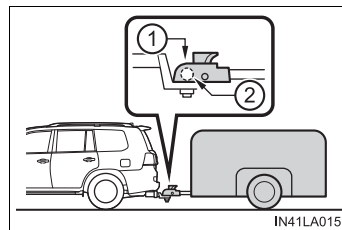

■ Before towing

Check that the following conditions are met:

- Ensure that your vehicle's tires are properly inflated. (→P. 558)
- Trailer tires are inflated according to the trailer manufacturer's recommendation.
- All trailer lights work as required by law.
- All lights work each time you connect them.
- The trailer ball is set at the proper height for the coupler on the trailer.
- The trailer is level when it is hitched.
Do not drive if the trailer is not level, and check for improper tongue weight, overloading, worn suspension, or other possible causes.
- The trailer cargo is securely loaded.
- The rear view mirrors conform to all applicable federal, state/provincial or local regulations. If they do not, install rear view mirrors appropriate for towing purposes.

■ Break-in schedule

If your vehicle is new or equipped with any new power train components (such as an engine, transmission, differential or wheel bearing), Toyota recommends that you do not tow a trailer until the vehicle has been driven for over 500 miles (800 km).

After the vehicle has been driven for over 500 miles (800 km), you can start towing. However, for the next 500 miles (800 km), drive the vehicle at a speed of less than 50 mph (80 km/h) when towing a trailer, and avoid full throttle acceleration.

■ Maintenance

- If you tow a trailer, your vehicle will require more frequent maintenance due to the additional load. (See “Owner’s Guide”, “Warranty and Services Guide”, “Owner’s Manual Supplement” or “Warranty Booklet”.)
- Retighten the fixing bolts of the towing ball and bracket after approximately 600 miles (1000 km) of trailer towing.

■ If trailer sway occurs

One or more factors (crosswinds, passing vehicles, rough roads, etc.) can adversely affect handling of your vehicle and trailer, causing instability.

● If trailer swaying occurs:

- Firmly grip the steering wheel. Steer straight ahead.
Do not try to control trailer swaying by turning the steering wheel.
- Begin releasing the accelerator pedal immediately but very gradually to reduce speed.
Do not increase speed. Do not apply vehicle brakes.

If you make no extreme correction with the steering or brakes, your vehicle and trailer should stabilize. (if enabled, Trailer Sway Control can also help to stabilize the vehicle and trailer.)

● After the trailer swaying has stopped:

- Stop in a safe place. Get all occupants out of the vehicle.
- Check the tires of the vehicle and the trailer.
- Check the load in the trailer.
Make sure the load has not shifted.
Make sure the tongue weight is appropriate, if possible.
- Check the load in the vehicle.
Make sure the vehicle is not overloaded after occupants get in.

If you cannot find any problems, the speed at which trailer swaying occurred is beyond the limit of your particular vehicle-trailer combination.

Drive at a lower speed to prevent instability. Remember that swaying of the towing vehicle-trailer increases as speed increases.

**WARNING****■ Trailer towing precautions**

To tow a trailer safely, use extreme care and drive the vehicle in accordance with the trailer’s characteristics and operating conditions. Failure to do so could cause an accident resulting in death or serious injury. Vehicle stability and braking performance are affected by trailer stability, brake setting and performance, and the hitch. Your vehicle will handle differently when towing a trailer.

 **WARNING****■ To avoid accident or injury**

- Do not exceed the TWR, unbraked TWR, GCWR, GVWR or GAWR.
- If the gross trailer weight is over 2000 lb. (907 kg), a sway control device with sufficient capacity is required.
- If the gross trailer weight is over 5000 lb. (2268 kg), a weight distributing hitch with sufficient capacity is required.
- Adjust the tongue weight within the appropriate range. Place heavier loads as close to the trailer axle as possible.
- Do not exceed 65 mph (104 km/h), the posted towing speed limit or the speed limit for your trailer as set forth in your trailer owner's manual, whichever is lowest. Slow down sufficiently before making a turn, in crosswinds, on wet or slippery surface, etc. to help avoid an accident. If you experience a vehicle-trailer instability from reducing a certain speed, slow down and make sure you keep your vehicle speed under the speed of which you experience the instability.
- Do not make jerky, abrupt or sharp turns.
- Do not apply the brakes suddenly as you may skid, resulting in jackknifing and loss of vehicle control. This is especially true on wet or slippery surfaces.
- Do not exceed the trailer hitch assembly weight, gross vehicle weight, gross axle weight and trailer tongue weight capacities.
- Do not use cruise control (if equipped) or dynamic radar cruise control (if equipped) when trailer towing.
- Slow down and downshift before descending steep or long downhill grades. Do not make sudden downshifts while descending steep or long downhill grades.
- Vehicle-trailer instability is more likely on steep long down hills. Before descending steep or long downhill grades, slow down and downshift. Do not make sudden downshifts when descending steep or long downhill grades. Avoid holding the brake pedal down too long or applying the brakes too frequently. This could cause the brakes to overheat and result in reduced braking efficiency.

 **WARNING****■ Hitch**

Trailer hitch assemblies have different weight capacities established by the hitch manufacturer. Even though the vehicle may be physically capable of towing a higher weight, the operator must determine the maximum weight rating of the particular hitch assembly and never exceed the maximum weight rating specified for the trailer-hitch. Exceeding the maximum weight rating set by the trailer-hitch manufacturer can cause an accident resulting in death or serious personal injuries.

■ When towing a trailer

Toyota recommends trailers with brakes that conform to any applicable federal and state/provincial regulations.

- If the gross trailer weight exceeds unbraked TWR, trailer brakes are required. Toyota recommends trailers with brakes that conform to all applicable federal and state/provincial regulations.
- Never tap into your vehicle's hydraulic system, as this will lower the vehicle's braking effectiveness.
- Never tow a trailer without using a safety chain securely attached to both the trailer and the vehicle. If damage occurs to the coupling unit or hitch ball, there is danger of the trailer wandering into another lane.

 **NOTICE****■ When installing a trailer hitch**

Use only the position recommended by your Toyota dealer. Do not install the trailer hitch on the bumper; this may cause body damage.

■ Do not directly splice trailer lights

Do not directly splice trailer lights. Directly splicing trailer lights may damage your vehicle's electrical system and cause a malfunction.

Dinghy towing

Your vehicle is not designed to be dinghy towed (with 4 wheels on the ground) behind a motor home.

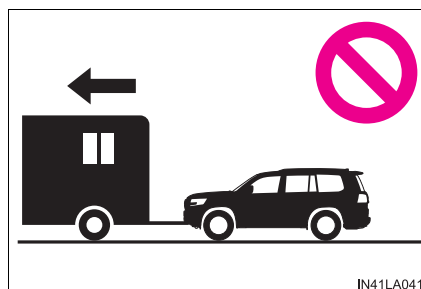

 NOTICE

- **To avoid serious damage to your vehicle**
Do not tow your vehicle with four wheels on the ground.

Engine (ignition) switch

Performing the following operations when carrying the electronic key on your person starts the engine or changes engine switch modes.

Starting the engine

- 1 Check that the parking brake is set.
- 2 Check that the shift lever is set in P.
- 3 Firmly depress the brake pedal.
 and a message will be displayed on the multi-information display. If it is not displayed, the engine cannot be started.
- 4 Press the engine switch.

The engine will crank until it starts or for up to 30 seconds, whichever is less.

Continue depressing the brake pedal until the engine is completely started.

The engine can be started from any engine switch mode.

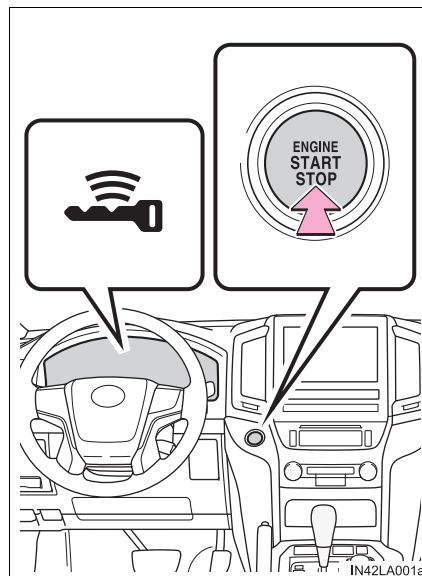

Stopping the engine

- 1 Stop the vehicle.
- 2 Shift the shift lever to P.
- 3 Set the parking brake. (→P. 204)
- 4 Press the engine switch.
- 5 Release the brake pedal and check that the display on the instrument cluster is off.

Changing engine switch modes

Modes can be changed by pressing the engine switch with brake pedal released. (The mode changes each time the switch is pressed.)

- ① Off*
The emergency flashers can be used.
- ② ACCESSORY mode
Some electrical components such as the audio system can be used.
“ACCESSORY” will be displayed on the multi-information display.
- ③ IGNITION ON mode
All electrical components can be used.
“IGNITION ON” will be displayed on the multi-information display.

*: If the shift lever is in a position other than P when turning off the engine, the engine switch will be turned to ACCESSORY mode, not to OFF.

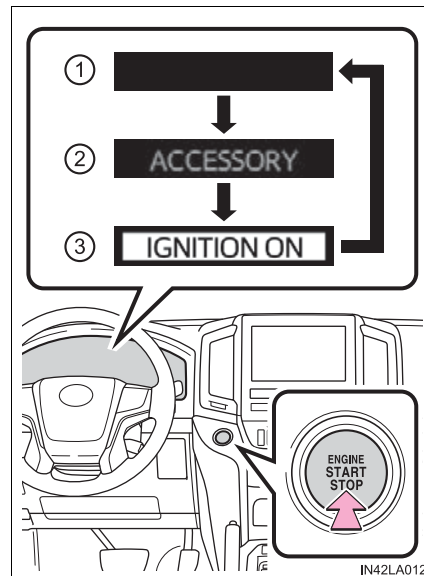

When stopping the engine with the shift lever in a position other than P

If the engine is stopped with the shift lever in a position other than P, the engine switch will not be turned off but instead be turned to ACCESSORY mode. Perform the following procedure to turn the switch off:

- 1 Check that the parking brake is set.
- 2 Shift the shift lever to P.
- 3 Check that "Turn Off Vehicle" is displayed on the multi-information display and then press the engine switch once.
- 4 Check that "Turn Off Vehicle" on the multi-information display is off.

■ Auto power off function

If the vehicle is left in ACCESSORY mode for more than 20 minutes or IGNITION ON mode (the engine is not running) for more than an hour with the shift lever in P, the engine switch will automatically turn off. However, this function cannot entirely prevent battery discharge. Do not leave the vehicle with the engine switch in ACCESSORY or IGNITION ON mode for long periods of time when the engine is not running.

■ Operation of the engine switch

- When operating the engine switch, one short, firm press is enough. If the switch is pressed improperly, the engine may not start or the engine switch mode may not change. It is not necessary to press and hold the switch.
- If attempting to restart the engine immediately after turning the engine switch off, the engine may not start in some cases. After turning the engine off, please wait a few seconds before restarting the engine.

■ Electronic key battery depletion

→P. 104

■ Conditions affecting operation

→P. 122

■ Note for the entry function

→P. 123

■ If the engine does not start

- The engine immobilizer system may not have been deactivated. (→P. 74)
Contact your Toyota dealer.
- Check that the shift lever is securely set in P. The engine may not start if the shift lever is displaced out of P.
A message will be displayed on the multi-information display.

■ Steering lock

After turning the engine switch off and opening and closing the doors, the steering wheel will be locked due to the steering lock function. Operating the engine switch again automatically cancels the steering lock.

■ When the steering lock cannot be released

A message will be displayed on the multi-information display.

Check that the shift lever is set in P. Press the engine switch while turning the steering wheel left and right.

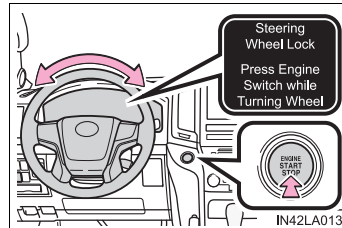
**■ Steering lock motor overheating prevention**

To prevent the steering lock motor from overheating, the motor may be suspended if the engine is turned on and off repeatedly in a short period of time. In this case, refrain from running the engine. After about 10 seconds, the steering lock motor will resume functioning.

■ When “Smart Key System Malfunction See Owner’s Manual” is displayed on the multi-information display

The system may be malfunctioning. Have the vehicle inspected by your Toyota dealer, immediately.

■ If the electronic key battery is depleted

→P. 479

■ If the smart key system has been deactivated in a customized setting

→P. 540

 **WARNING****■ When starting the engine**

Always start the engine while sitting in the driver's seat. Do not depress the accelerator pedal while starting the engine under any circumstances. Doing so may cause an accident resulting in death or serious injury.

■ Caution while driving

If engine failure occurs while the vehicle is moving, do not lock or open the doors until the vehicle reaches a safe and complete stop. Activation of the steering lock in this circumstance may lead to an accident, resulting in death or serious injury.

■ Stopping the engine in an emergency

- If you want to stop the engine in an emergency while driving the vehicle, press and hold the engine switch for more than 2 seconds, or press it briefly 3 times or more in succession. (→P. 501)
However, do not touch the engine switch while driving except in an emergency. Turning the engine off while driving will not cause loss of steering or braking control, but the power assist to these systems will be lost. This will make it more difficult to steer and brake, so you should pull over and stop the vehicle as soon as it is safe to do so.
- If the engine switch is operated while the vehicle is running, a warning message will be shown on the multi-information display and a buzzer sounds.
- When restarting the engine after it was turned off while driving, shift the shift lever to N and press the engine switch.

 NOTICE

■ **To prevent battery discharge**

- Do not leave the engine switch in ACCESSORY or IGNITION ON mode for long periods of time without the engine running.
- If “ACCESSORY” or “IGNITION ON” is displayed on the multi-information display, the engine switch is not off. When exiting the vehicle, always check that the engine switch is off.
- Do not stop the engine when the shift lever is in a position other than P. If the engine is stopped in another shift lever position, the engine switch will not be turned off but instead be turned to ACCESSORY mode. If the vehicle is left in ACCESSORY mode, battery discharge may occur.

■ **When starting the engine**

- Do not race a cold engine.
- If the engine becomes difficult to start or stalls frequently, have your vehicle checked by your Toyota dealer immediately.

■ **Symptoms indicating a malfunction with the engine switch**

If the engine switch seems to be operating somewhat differently than usual, such as the switch sticking slightly, there may be a malfunction. Contact your Toyota dealer immediately.

Automatic transmission

Shifting the shift lever

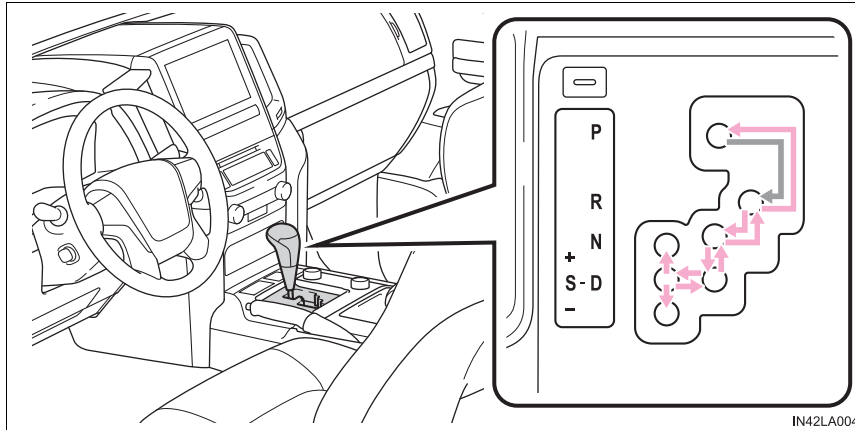

← While the engine switch is in IGNITION ON mode, move the shift lever with the brake pedal depressed.

When shifting the shift lever between P and D, make sure that the vehicle is completely stopped.

4

Driving

Shift position purpose

Shift position	Purpose and condition
P	Parking the vehicle/starting the engine
R	Reversing
N	Neutral (Condition in which the power is not transmitted)
D	Normal driving ^{*1}
S	S mode driving ^{*2} (→P. 201)

^{*1}: Shifting to the D position allows the system to select a gear suitable for the driving conditions. Setting the shift lever to the D position is recommended for normal driving.

^{*2}: Selecting shift ranges using S mode restricts the upper limit of the possible gear ranges, controls engine braking forces, and prevents unnecessary upshifting.

Selecting a driving mode

The following patterns can be selected to suit current driving and operating conditions.

■ Power mode

For powerful acceleration and driving in mountainous regions.

Press the button again to cancel power mode.

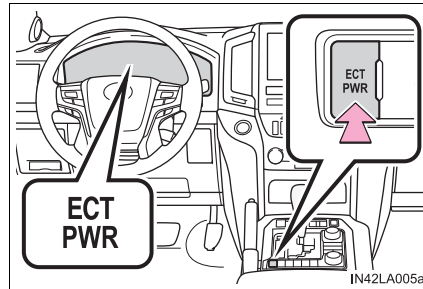

■ Second start mode

For starting on slippery road surfaces, such as on snow.

Press the button again to cancel second start mode.

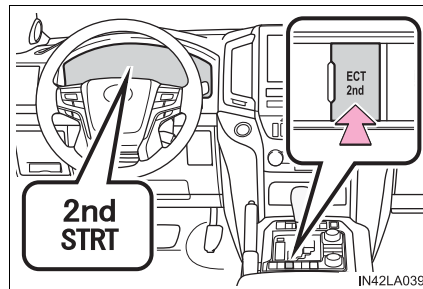

Changing shift ranges in S mode

When the shift lever is in the S position, the shift lever can be operated as follows:

- ① Upshifting
- ② Downshifting

The selected shift range will be displayed in the meter.

The initial shift range in S mode is set automatically to 6, 5 or 4 according to vehicle speed. However, the initial shift range may be set to 3 or 2 if AI-SHIFT has operated while the shift lever was in the D position. (→P. 202)

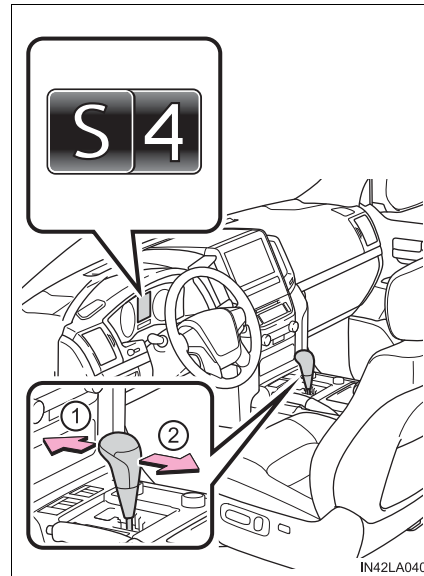

4

Driving

■ Shift ranges and their functions

- Automatically selecting gears between 1 and 8 according to vehicle speed and driving conditions. But, the gear is limited according to selected shift range.
- You can choose from 8 levels of engine braking force.
- A lower shift range will provide greater engine braking force than a higher shift range, and the engine speed will also increase.

■ Driving on a downhill

On declines, there may be case where the vehicle shifts down automatically to obtain engine braking. As a result of the downshifting, the engine speed may increase.

■ Second start mode automatic deactivation

Second start mode is automatically deactivated if the engine is turned off after driving in second start mode.

■ S mode

When the shift range is 7 or lower, holding the shift lever toward “+” sets the shift range to 8.

■ AI-SHIFT

AI-SHIFT automatically selects the suitable gear according to driver performance and driving conditions.

AI-SHIFT automatically operates when the shift lever is in the D position. (Shifting the shift lever to the S position cancels the function.)

■ When driving with cruise control or dynamic radar cruise control activated

Even when performing the following actions with the intent of enabling engine braking, engine braking will not activate because cruise control or radar cruise control will not be canceled.

- While driving in S mode, downshifting to 7, 6, 5 or 4. (→P. 257, 269)
- When switching the driving mode to power mode while driving in D position. (→P. 200)

■ If the shift lever cannot be shifted from P

→P. 539

■ If the “S” indicator does not come on even after shifting the shift lever to S

This may indicate a malfunction in the automatic transmission system. Have the vehicle inspected by your Toyota dealer immediately.

(In this situation, the transmission will operate in the same manner as when the shift lever is in D.)

■ Downshift restriction warning buzzer (S mode)

To help ensure safety and driving performance, downshifting operation may sometimes be restricted. In some circumstances, downshifting may not be possible even when the shift lever is operated. (A buzzer will sound twice.)

WARNING

■ When driving on slippery road surfaces

Do not accelerate or shift gears suddenly.

Sudden changes in engine braking may cause the vehicle to spin or skid, resulting in an accident.

Turn signal lever

Operating instructions

The turn signal lever can be used to show the following intentions of the driver:

- ① Right turn
- ② Lane change to the right (push and hold the lever partway)
The right hand signals will flash until you release the lever.
- ③ Lane change to the left (push and hold the lever partway)
The left hand signals will flash until you release the lever.
- ④ Left turn

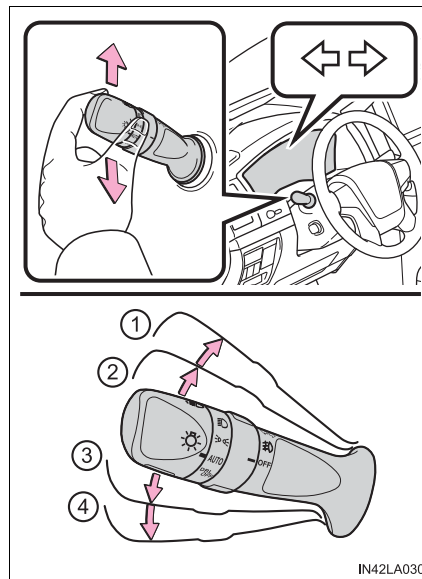

■ Turn signals can be operated when

The engine switch is in IGNITION ON mode.

■ If the indicator flashes faster than usual

Check that a light bulb in the front or rear turn signal lights has not burned out.

Parking brake

- ① Sets the parking brake
Fully set the parking brake while depressing the brake pedal.
- ② Releases the parking brake
Slightly raise the lever and lower it completely while pressing the button.

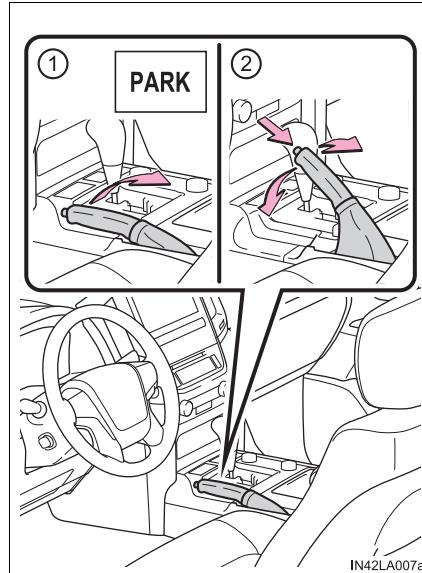

■ Parking brake engaged warning buzzer

A buzzer will sound if the vehicle is driven with the parking brake engaged. A warning message is displayed on the multi-information display.

■ Usage in winter time

→P. 369

⚠ NOTICE

■ Before driving



Fully release the parking brake. Driving the vehicle with the parking brake set will lead to brake components overheating, which may affect braking performance and increase brake wear.

Headlight switch

The headlights can be operated manually or automatically.

Operating instructions

Turning the end of the lever turns on the lights as follows:

- ①  The daytime running lights turn off.
- ②  The side marker, parking, tail, license plate, daytime running lights (→P. 207) and instrument panel lights turn on.
- ③  The headlights and all lights listed above (except daytime running lights) turn on.
- ④ **AUTO** The headlights, daytime running lights (→P. 207) and all lights listed above turn on and off automatically (when the engine switch is in IGNITION ON mode).

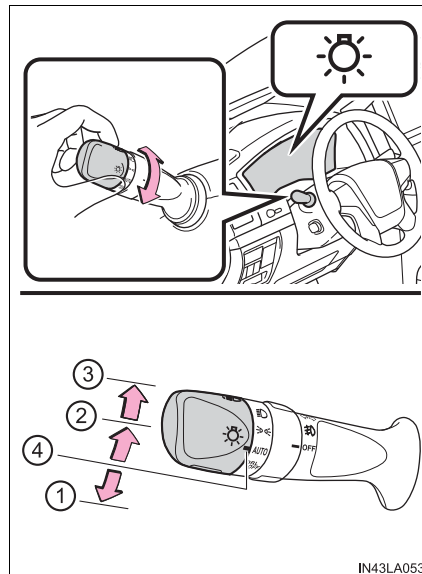

Turning on the high beam headlights

- ① With the headlights on, push the lever forward to turn on the high beams.

When the light switch is in "AUTO" position, the Automatic High Beam system will be activated. (→P. 209)

Pull the lever back to the center position to turn the high beams off.

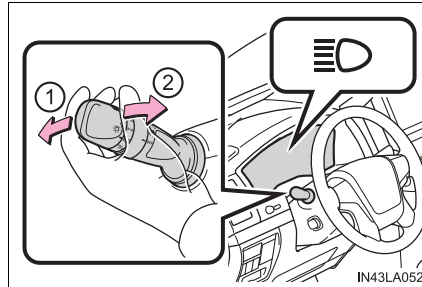

- ② Pull the lever toward you to turn on the high beams.

Release the lever to turn them off. You can flash the high beams with the headlights on or off.

■ Daytime running light system

- To make your vehicle more visible to other drivers during daytime driving, the daytime running lights turn on automatically (at a reduced intensity) whenever the engine is started and the parking brake is released. Daytime running lights are not designed for use at night.
For the U.S.A.: Daytime running lights can be turned off by operating the switch.
- Compared to turning on the headlights, the daytime running light system offers greater durability and consumes less electricity, so it can help improve fuel economy.

■ Headlight control sensor

The sensor may not function properly if an object is placed on the sensor, or anything that blocks the sensor is affixed to the windshield.

Doing so interferes with the sensor detecting the level of ambient light and may cause the automatic headlight system to malfunction.

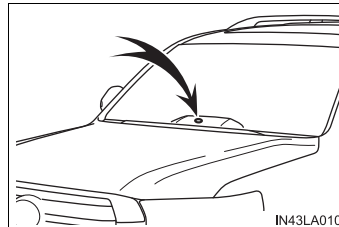

■ Automatic light off system

- When the headlights are on: The headlights and tail lights turn off 30 seconds after a door is opened and closed if the engine switch has been switched to ACCESSORY or OFF mode.
- When only the tail lights are on: The tail lights turn off automatically if the engine switch is switched to ACCESSORY or OFF mode and driver's door is opened.

To turn the lights on again, turn the engine switch to IGNITION ON mode, or turn the light switch off once and then back to the $\Rightarrow \text{D}$ or $\Rightarrow \text{D}$ position.

■ Automatic headlight leveling system

The level of the headlights is automatically adjusted according to the number of passengers and the loading condition of the vehicle to ensure that the headlights do not interfere with other road users.

■ Welcome lighting

If the headlight switch is turned to **AUTO** and the surrounding area is dark, unlocking the doors using the smart key system or wireless remote control will turn the parking lights and tail lights on automatically.

■ If the automatic headlight leveling system warning light flashes

It may indicate a malfunction in the system. Contact your Toyota dealer.

■ Light reminder buzzer

A buzzer sounds when the engine switch is turned to ACCESSORY or OFF mode and the driver's door is opened while the tail lights are turned on.

■ **Customization**

Settings (e.g. light sensor sensitivity) can be changed.
(Customizable features: →P. 574)

 NOTICE

■ **To prevent battery discharge**

Do not leave the lights on longer than necessary when the engine is not running.

Automatic High Beam

The Automatic High Beam uses an in-vehicle camera sensor to assess the brightness of streetlights, the lights of vehicles ahead etc., and automatically turns the high beam on or off as necessary.

WARNING

■ Limitations of the Automatic High Beam

Do not rely on the Automatic High Beam. Always drive safely, taking care to observe your surroundings and turning the high beam on or off manually if necessary.

■ To prevent incorrect operation of the Automatic High Beam system

Do not overload the vehicle.

NOTICE

■ Notes when using the Automatic High Beam system

▶ Vehicles without PCS (Pre-Collision System):

Observe the following to ensure that the Automatic High Beam functions correctly.

- Do not touch the camera sensor.
- Do not subject the inside rear view mirror or the camera sensor to a strong impact.
- Do not disassemble the camera sensor.
- Do not spill liquid onto the inside rear view mirror or the camera sensor.
- Do not apply window tinting or stickers to the camera sensor or the area of windshield near the camera sensor.
- Do not place items on the dashboard. There is a possibility that the camera sensor will mistake items reflected in the windshield for streetlights, the headlights of other vehicles, etc.
- Do not install a parking tag or any other accessories near or around the inside rear view mirror and the camera sensor.
- Do not modify the vehicle.
- Do not replace windshield with a non-genuine windshield.
Contact your Toyota dealer.

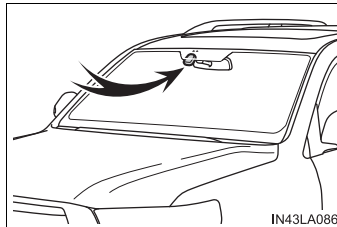

▶ Vehicles with PCS (Pre-Collision System):

→P. 230

Activating the Automatic High Beam system

- 1 Push the lever away from you with the headlight switch in the **AUTO** or  position.

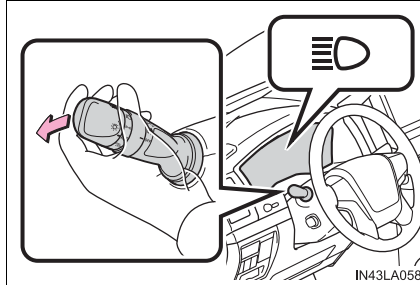

- 2 Press the Automatic High Beam switch.

The Automatic High Beam indicator will come on when the headlights are turned on automatically to indicate that the system is active.

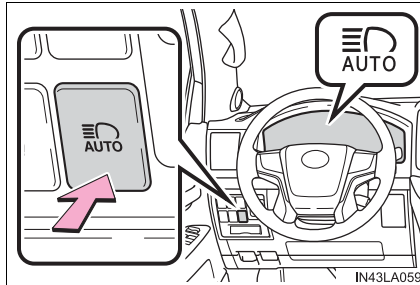

Turning the high beam on/off manually

■ Switching to low beam

Pull the lever to original position.

The Automatic High Beam indicator will turn off.

Push the lever away from you to activate the Automatic High Beam system again.

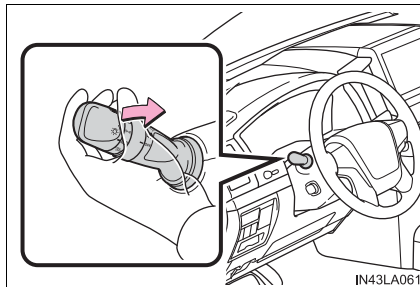

■ Switching to high beam

Press the Automatic High Beam switch.

The Automatic High Beam indicator will turn off and the high beam indicator will turn on.

Press the switch to activate the Automatic High Beam system again.

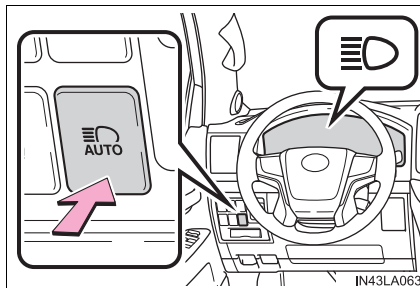

■ High beam automatic turning on or off conditions

- When all of the following conditions are fulfilled, the high beam will be automatically turned on (after approximately 1 second):
 - Vehicle speed is above approximately 21 mph (34 km/h).
 - The area ahead of the vehicle is dark.
 - There are no vehicles ahead with headlights or tail lights turned on.
 - There are few streetlights on the road ahead.
- If any of the following conditions are fulfilled, the high beam will be automatically turned off:
 - Vehicle speed drops below approximately 17 mph (27 km/h).
 - The area ahead of the vehicle is not dark.
 - Vehicles ahead have headlights or tail lights turned on.
 - There are many streetlights on the road ahead.

■ Camera sensor detection information

- The high beam may not be automatically turned off in the following situations:
 - When oncoming vehicles suddenly appear from a curve
 - When the vehicle is cut in front of by another vehicle
 - When vehicles ahead are hidden from sight due to repeated curves, road dividers or roadside trees
 - When vehicles ahead appear from the faraway lane on wide road
 - When vehicles ahead have no lights
- The high beam may be turned off if a vehicle ahead that is using fog lights without using the headlights is detected.
- Houselights, streetlights, traffic signals, and illuminated billboards or signs may cause the high beam to switch to the low beams, or the low beams to remain on.
- The following factors may affect the amount of time taken to turn the high beam on or off:
 - The brightness of headlights, fog lights, and tail lights of vehicles ahead
 - The movement and direction of vehicles ahead
 - When a vehicle ahead only has operational lights on one side
 - When a vehicle ahead is a two-wheeled vehicle
 - The condition of the road (gradient, curve, condition of the road surface etc.)
 - The number of passengers and amount of baggage
- The high beam may be turned on or off when the driver does not expect it.
- Bicycles or similar objects may not be detected.

- In the situations shown below, the system may not be able to accurately detect surrounding brightness levels. This may cause the low beams to remain on or the high beams to cause problems for pedestrians, vehicles ahead or other parties. In these cases, manually switch between the high and low beams.
 - In bad weather (rain, snow, fog, sandstorms etc.)
 - The windshield is obscured by fog, mist, ice, dirt etc.
 - The windshield is cracked or damaged.
 - The inside rear view mirror or camera sensor is deformed or dirty.
 - The camera sensor temperature is extremely high.
 - Surrounding brightness levels are equal to those of headlights, tail lights or fog lights.
 - Vehicles ahead have headlights that are either switched off, dirty, are changing color, or are not aimed properly.
 - When driving through an area of intermittently changing brightness and darkness
 - When frequently and repeatedly driving ascending/descending roads, or roads with rough, bumpy or uneven surfaces (such as stone-paved roads, gravel tracks etc.)
 - When frequently and repeatedly taking curves or driving on a winding road
 - There is a highly reflective object ahead of the vehicle, such as a sign or a mirror.
 - The back of a vehicle ahead is highly reflective, such as a container on a truck.
 - The vehicle's headlights are damaged or dirty.
 - The vehicle is listing or tilting, due to a flat tire, a trailer being towed etc.
 - The high beam and low beam are repeatedly being switched between in an abnormal manner.
 - The driver believes that the high beam may be causing problems or distress to other drivers or pedestrians nearby.
- **If a warning message of the Automatic High Beam is displayed...**

It may indicate a malfunction in the system. Contact your Toyota dealer.

■ Temporary lowering sensor sensitivity

The sensitivity of the sensor can be temporarily lowered.

▶ Vehicles without PCS (Pre-Collision System):

To lower the sensitivity, push and hold the “AUTO” button on the inside rear view mirror for 15 to 20 seconds, and release. The indicator light on the inside rear view mirror will flash to indicate that the sensitivity has been lowered.

When the engine switch is turned off, the sensitivity will be returned to its normal level.

▶ Vehicles with PCS (Pre-Collision System):

1 Turn the engine switch off while the following conditions are met.

- The headlight switch is in **AUTO** .
- The headlight switch lever is in low beam position.

2 Turn the engine switch to IGNITION ON mode.

3 Within 30 seconds after 2, repeat pushing the headlight switch lever to the high beam position then pulling it to the low beam position quickly 10 times, then leave the lever in high beam position.

Automatic High Beam (headlights) may turn on even the vehicle is stopped.

Fog light switch

The fog lights secure excellent visibility in difficult driving conditions, such as in rain and fog.

- ① OFF Turns the fog lights off
- ②  Turns the fog lights on

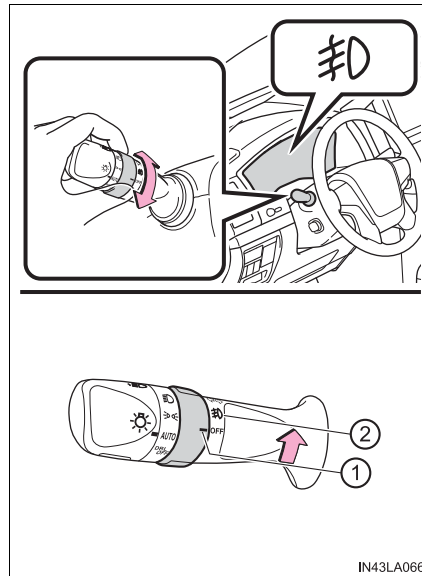

■ **Fog lights can be used when**
The headlights are on in low beam.

 **NOTICE**

■ **To prevent battery discharge**

Do not leave the lights on longer than necessary when the engine is not running.

Windshield wipers and washer

Operating the wiper lever

The wiper operation is selected by moving the lever as follows.

► Intermittent windshield wipers with interval adjuster

- ① Intermittent operation
- ② Low speed operation
- ③ High speed operation
- ④ Temporary operation

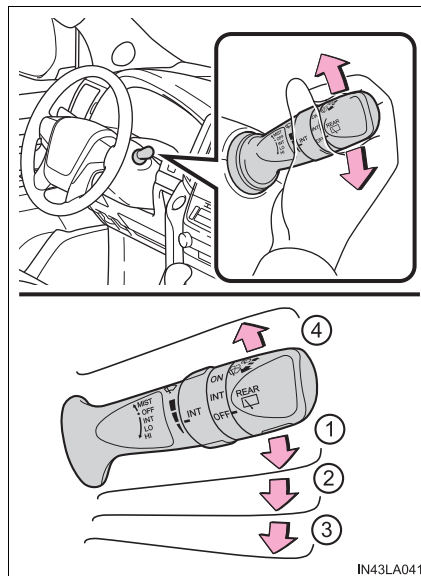

Wiper intervals can be adjusted when intermittent operation is selected.

- ⑤ Increases the intermittent windshield wiper frequency
- ⑥ Decreases the intermittent windshield wiper frequency

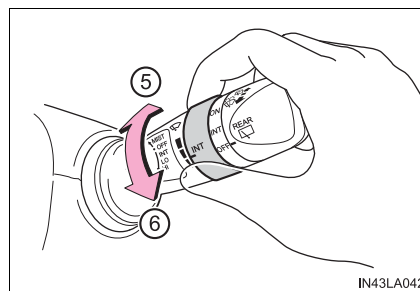

⑦ Washer/wiper dual operation

The wipers will automatically operate a couple of times after the washer squirts.

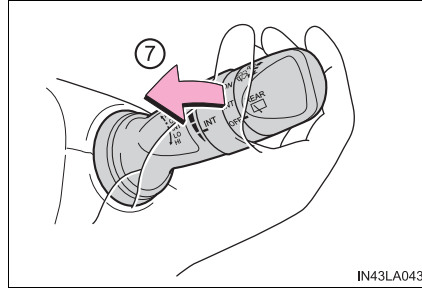

► Rain-sensing windshield wipers

① Rain-sensing operation ("AUTO")

② Low speed operation

③ High speed operation

④ Temporary operation

When "AUTO" is selected, the wipers will operate automatically when the sensor detects falling rain. The system automatically adjusts wiper timing in accordance with rain volume and vehicle speed.

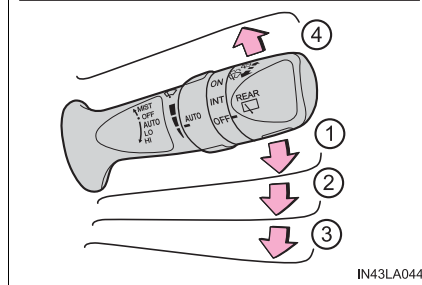
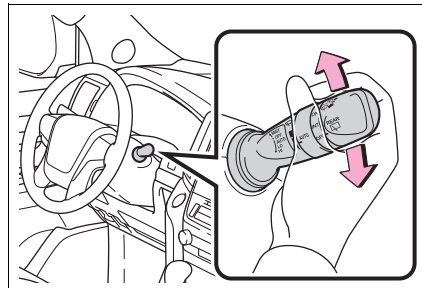

The sensor sensitivity can be adjusted when “AUTO” is selected.

- ⑤ Increases the sensitivity
- ⑥ Decreases the sensitivity

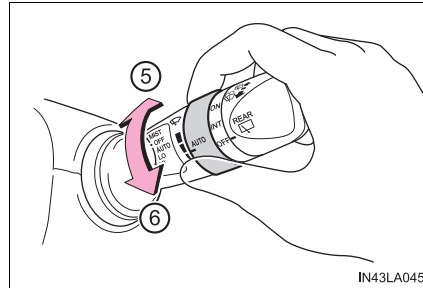

- ⑦ Washer/wiper dual operation

The wipers operate automatically. (After operating several times, the wipers operate one more time after a short delay to prevent dripping.)

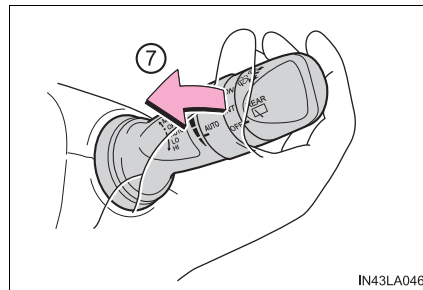

■ The windshield wiper and washer can be operated when

The engine switch is in IGNITION ON mode.

■ Raindrop sensor (vehicles with rain-sensing windshield wipers)

- The raindrop sensor judges the amount of raindrops.

An optical sensor is adopted. It may not operate properly when sunlight from the rising or setting of the sun intermittently strikes the windshield, or if bugs etc. are present on the windshield.

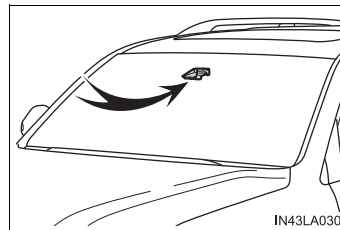

- If the wiper switch is turned to the “AUTO” position while the engine switch is in IGNITION ON mode, the wipers will operate once to show that “AUTO” mode is activated.
- When the sensor sensitivity ring is turned toward high while in “AUTO” mode, the wipers will operate once to indicate that the sensor sensitivity is enhanced.
- If the temperature of the rain drop sensor is 185°F (85°C) or higher, or -22°F (-30°C) or lower, the automatic operation may not occur. In this case, operate the wipers in any mode other than “AUTO”.

■ **Effects of vehicle speed on wiper operation (vehicles with rain-sensing windshield wipers)**

Vehicle speed affects the wiper operation when the washer is being used (delay until drip prevention wiper sweep occurs) even when the wipers are not in "AUTO" mode.

With the low speed operation selected, wiper operation will be switched from low speed to intermittent wiper operation only when the vehicle is stationary. (However, when the sensor sensitivity is adjusted to the highest level, the mode cannot be switched.)

■ **If no windshield washer fluid sprays**

Check that the washer nozzles are not blocked if there is washer fluid in the windshield washer fluid reservoir.

 WARNING
<p>■ Caution regarding the use of windshield wipers in "AUTO" mode (vehicles with rain-sensing windshield wipers)</p> <p>The windshield wipers may operate unexpectedly if the sensor is touched or the windshield is subject to vibration in "AUTO" mode. Take care that your fingers etc. anything else does not become caught in the windshield wipers.</p> <p>■ Caution regarding the use of washer fluid</p> <p>When it is cold, do not use the washer fluid until the windshield becomes warm. The fluid may freeze on the windshield and cause low visibility. This may lead to an accident, resulting in death or serious injury.</p>

 NOTICE
<p>■ When the windshield is dry</p> <p>Do not use the wipers, as they may damage the windshield.</p> <p>■ When the washer fluid tank is empty</p> <p>Do not operate the switch continually as the washer fluid pump may over-heat.</p> <p>■ When there is no washer fluid spray from the nozzle</p> <p>Damage to the washer fluid pump may be caused if the lever is pulled toward you and held continually.</p> <p>■ When a nozzle becomes blocked</p> <p>Do not try to clear it with a pin or other object. The nozzle will be damaged.</p>

Rear window wiper and washer

Turning the end of the lever turns on the rear window wiper and washer.

- ① Intermittent operation
- ② Normal operation

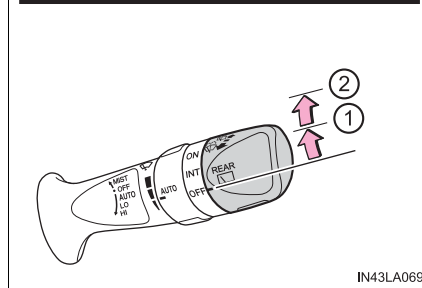
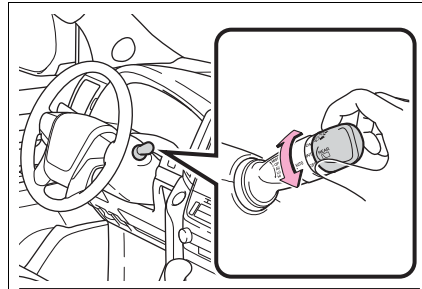

- ③ Washer/wiper dual operation

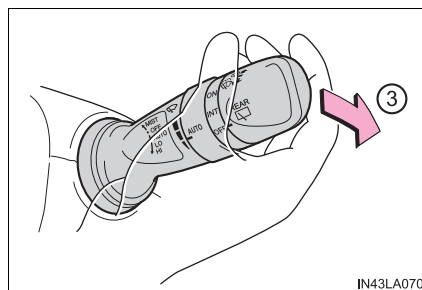

■ **The rear window wiper and washer can be operated when**

The engine switch is in IGNITION ON mode.

■ **If no washer fluid sprays**

Check that the washer nozzles are not blocked if there is washer fluid in the washer fluid reservoir.



NOTICE

■ **When the rear window is dry**

Do not use the wiper, as it may damage the rear window.

■ **When the washer fluid tank is empty**

Do not operate the switch continually as the washer fluid pump may over-heat.

Headlight cleaner switch*

Washer fluid can be sprayed on the headlights.

Press the switch to clean the headlights.

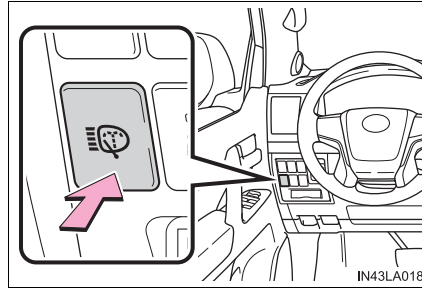

■ The headlight cleaners can be operated when

The engine switch is in IGNITION ON mode and the headlight switch is turned on.

⚠ NOTICE

■ When the washer fluid tank is empty

Do not press the switch continually as the washer fluid pump may overheat.

*: If equipped

Opening the fuel tank cap

Perform the following steps to open the fuel tank cap.

Before refueling the vehicle

- Turn the engine switch off and ensure that all the doors and windows are closed.
- Confirm the type of fuel.

Fuel types

→P. 560

Fuel tank opening for unleaded gasoline

To help prevent incorrect fueling, your Toyota has a fuel tank opening that only accommodates the special nozzle on unleaded fuel pumps.

WARNING

■ When refueling the vehicle

Observe the following precautions while refueling the vehicle. Failure to do so may result in death or serious injury.

- After exiting the vehicle and before opening the fuel door, touch an unpainted metal surface to discharge any static electricity. It is important to discharge static electricity before refueling because sparks resulting from static electricity can cause fuel vapors to ignite while refueling.
- Always hold the grips on the fuel tank cap and turn it slowly to remove it. A whooshing sound may be heard when the fuel tank cap is loosened. Wait until the sound cannot be heard before fully removing the cap. In hot weather, pressurized fuel may spray out of the filler neck and cause injury.
- Do not allow anyone that has not discharged static electricity from their body to come close to an open fuel tank.
- Do not inhale vaporized fuel.
Fuel contains substances that are harmful if inhaled.
- Do not smoke while refueling the vehicle.
Doing so may cause the fuel to ignite and cause a fire.
- Do not return to the vehicle or touch any person or object that is statically charged.
This may cause static electricity to build up, resulting in a possible ignition hazard.

 **WARNING****■ When refueling**

Observe the following precautions to prevent fuel overflowing from the fuel tank:

- Securely insert the fuel nozzle into the fuel filler neck.
- Stop filling the tank after the fuel nozzle automatically clicks off.
- Do not top off the fuel tank.

 **NOTICE****■ Refueling**

Do not spill fuel during refueling.

Doing so may damage the vehicle, such as causing the emission control systems to operate abnormally or damaging fuel system components or the vehicle's painted surface.

Opening the fuel tank cap

- 1 Pull the lever.

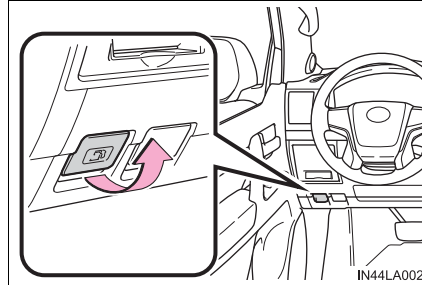

- 2 Turn the fuel tank cap slowly to open.

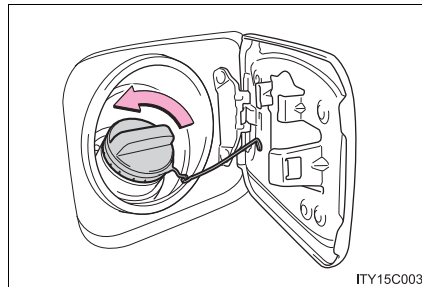

- 3 Hang the fuel tank cap on the back of the fuel filler door.

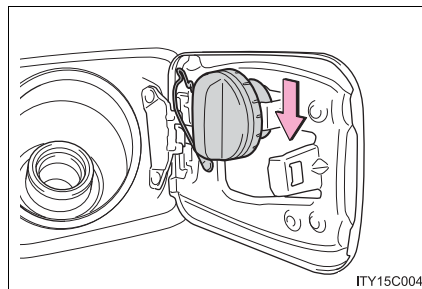

Closing the fuel tank cap

After refueling, turn the fuel tank cap until you hear a click. Once the cap is released, it will turn slightly in the opposite direction.

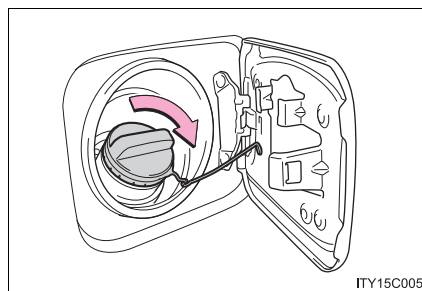

 **WARNING**

■ When replacing the fuel tank cap

Do not use anything but a genuine Toyota fuel tank cap designed for your vehicle. Doing so may cause a fire or other incident which may result in death or serious injury.

Toyota Safety Sense P*

The Toyota Safety Sense P consists of the following drive assist systems and contributes to a safe and comfortable driving experience:

◆ **PCS (Pre-Collision System)**

→P. 233

◆ **LDA (Lane Departure Alert)***

→P. 248

◆ **Dynamic radar cruise control***

→P. 257

◆ **AHB (Automatic High Beam)***

→P. 209

 **WARNING**

■ **Toyota Safety Sense P**

The Toyota Safety Sense P is designed to operate under the assumption that the driver will drive safely, and is designed to help reduce the impact to the occupants and the vehicle in the case of a collision or assist the driver in normal driving conditions.

As there is a limit to the degree of recognition accuracy and control performance that this system can provide, do not overly rely on this system. The driver is always responsible for paying attention to the vehicle's surroundings and driving safely.

*: If equipped

Vehicle data recording

The pre-collision system is equipped with a sophisticated computer that will record certain data, such as:

- How far (if at all) the driver was depressing the accelerator and/or brake pedal
- Vehicle speed
- Operation status of the pre-collision system functions
- Information (such as the distance and relative speed between your vehicle and the vehicle ahead or other objects)

Additionally, if the pre-collision braking function is operating, image information from the camera sensor will also be recorded. The pre-collision system does not record conversations, sounds or pictures.

● Data usage

Toyota may use the data recorded in this computer to diagnose malfunctions, conduct research and development, and improve quality.

Toyota will not disclose the recorded data to a third party except:

- With the consent of the vehicle owner or with the consent of the lessee if the vehicle is leased
- In response to an official request by the police, a court of law or a government agency
- For use by Toyota in a lawsuit
- For research purposes where the data is not tied to a specific vehicle or vehicle owner

● Recorded image information can be erased using a specialized device.

The image information recording function can be disabled. However, if the function is disabled, data from when the pre-collision system operates will not be available.

Sensors

Two types of sensors, located behind the front grille and windshield, detect information necessary to operate the drive assist systems.

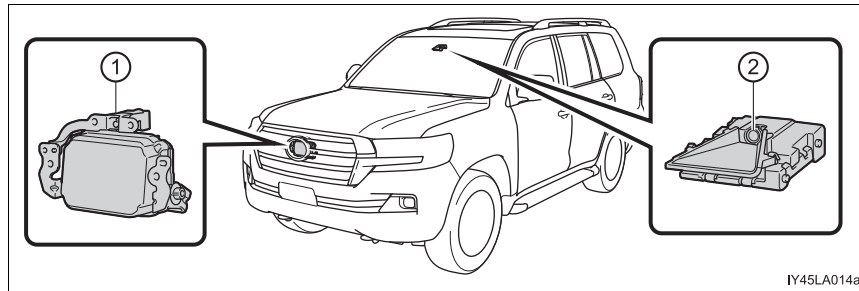

① Radar sensor

② Camera sensor

⚠ WARNING**■ To avoid malfunction of the radar sensor**

Observe the following precautions.

Otherwise, the radar sensor may not operate properly, possibly leading to an accident resulting in death or serious injury.

- Keep the radar sensor and front grille emblem clean at all times.

- ① Radar sensor
- ② Front grille emblem

If the front of the radar sensor or the front or back of the front grille emblem is dirty or covered with water droplets, snow, etc., clean it.

Clean the radar sensor and front grille emblem with a soft cloth so you do not mark or damage them.

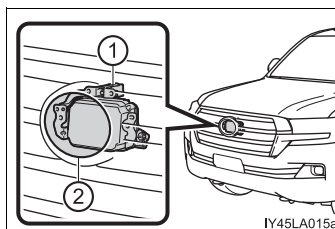

- Do not attach accessories, stickers (including transparent stickers) or other items to the radar sensor, front grille emblem or surrounding area.
- Do not subject the radar sensor or surrounding area to a strong impact. If the radar sensor, front grille, or front bumper has been subjected to a strong impact, have the vehicle inspected by your Toyota dealer.
- Do not disassemble the radar sensor.
- Do not modify or paint the radar sensor, front grille emblem or surrounding area.
- If the radar sensor, front grille, or front bumper needs to be removed and installed, or replaced, contact your Toyota dealer.
- The radar sensor complies with relevant radio wave regulations, as shown by the label attached to the sensor. Do not remove the label. Additionally, disassembly or modification of the radar sensor may be prohibited by law.

⚠ WARNING

■ To avoid malfunction of the camera sensor

Observe the following precautions.

Otherwise, the camera sensor may not operate properly, possibly leading to an accident resulting in death or serious injury.

- Keep the windshield clean at all times.

If the windshield is dirty or covered with an oily film, water droplets, snow, etc., clear the windshield.

If the inner side of the windshield where the camera sensor is installed is dirty, contact your Toyota dealer.

- Do not install an antenna or attach stickers (including transparent stickers) or other items to the area of the windshield in front of the camera sensor (shaded area in the illustration).

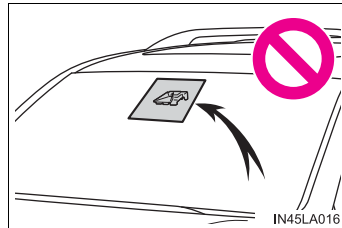

- If the part of the windshield in front of the camera sensor is fogged up or covered with condensation or ice, use the windshield defogger to remove the fog, condensation or ice. (→P. 374)
- Do not apply glass coating agents to the area of the windshield in front of the camera sensor.
Glass coating agents can be applied to the windshield in areas other than in front of the camera sensor. However, it will still be necessary to use the wipers if the area of the windshield in front of the camera sensor is covered with water droplets.
- If water droplets cannot be properly removed from the area of the windshield in front of the camera sensor by the windshield wipers, replace the wiper insert or wiper blade.
If the wiper inserts or wiper blades need to be replaced, contact your Toyota dealer.
- Do not attach window tinting to the windshield.
- Replace the windshield if it is damaged or cracked.
If the windshield needs to be replaced, contact your Toyota dealer.
- Do not get the camera sensor wet.
- Do not allow bright lights to shine into the camera sensor.
- Do not dirty or damage the camera sensor.
When cleaning the inside of the windshield, do not allow glass cleaner to contact the lens. Also, do not touch the lens.
If the lens is dirty or damaged, contact your Toyota dealer.
- Do not subject the camera sensor to a strong impact.

 **WARNING**

- Do not change the installation position or direction of the camera sensor or remove it.
- Do not disassemble the camera sensor.
- Do not install an electronic device or device that emits strong electric waves near the camera sensor.
- Do not modify any components of the vehicle around the camera sensor (inside rear view mirror, sun visors, etc.) or ceiling.
- Do not attach any accessories that may obstruct the camera sensor to the hood, front grille or front bumper. Contact your Toyota dealer for details.
- If a surfboard or other long object is to be mounted on the roof, make sure that it will not obstruct the camera sensor.
- Do not modify the headlights or other lights.

■ **Certification**

FCC ID: HYQDNMWR008

NOTE:

This device complies with part 15 of the FCC Rules. Operation is subject to the following two conditions: (1) This device may not cause harmful interference, and (2) this device must accept any interference received, including interference that may cause undesired operation.

FCC WARNING:

Changes or modifications not expressly approved by the party responsible for compliance could void the user's authority to operate the equipment.

Radiofrequency radiation exposure Information:

This equipment complies with FCC radiation exposure limits set forth for an uncontrolled environment. This equipment should be installed and operated with minimum distance of 20 cm between the radiator (antenna) and your body. This transmitter must not be co-located or operating in conjunction with any other antenna or transmitter.

PCS (Pre-Collision System)*

The pre-collision system uses a radar sensor and camera sensor to detect vehicles and pedestrians*¹ in front of your vehicle. When the system determines that the possibility of a frontal collision with a vehicle or pedestrian is high, a warning operates to urge the driver to take evasive action and the potential brake pressure is increased to help the driver avoid the collision. If the system determines that the possibility of a frontal collision with a vehicle or pedestrian is extremely high, the brakes are automatically applied*² to help avoid the collision or help reduce the impact to the vehicle occupants and the vehicle in the collision.

The pre-collision system can be disabled/enabled and the warning timing can be changed. (→P. 237)

*1: Depending on the region in which the vehicle was sold, the pedestrian detection function may not be available. Contact your Toyota dealer for details.

*2: Depending on the region in which the vehicle was sold, the pre-collision braking function (automatic braking function) may not be available. Contact your Toyota dealer for details.

4

Driving

◆ Pre-collision warning

When the system determines that the possibility of a frontal collision is high, a buzzer will sound and a warning message will be displayed on the multi-information display to urge the driver to take evasive action.

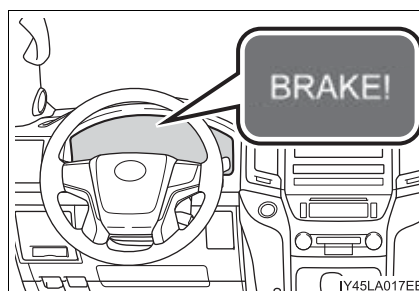

◆ Pre-collision brake assist

When the system determines that the possibility of a frontal collision is high, the system applies greater braking force in relation to how strongly the brake pedal is depressed.

*: If equipped

◆ **Pre-collision braking**^{*3}

When the system determines that the possibility of a frontal collision is high, the system warns the driver. If the system determines that the possibility of a collision is extremely high, the brakes are automatically applied to help avoid the collision or reduce the collision speed.

^{*3}: Depending on the region in which the vehicle was sold, the pre-collision braking function may not be available.

⚠ WARNING**■ Limitations of the pre-collision system**

- The driver is solely responsible for safe driving. Always drive safely, taking care to observe your surroundings.

Do not use the pre-collision system instead of normal braking operations under any circumstances. This system will not prevent collisions or lessen collision damage or injury in every situation. Do not overly rely on this system. Failure to do so may lead to an accident, resulting in death or serious injury.

- Although this system is designed to help avoid and reduce the impact of a collision, its effectiveness may change according to various conditions, therefore the system may not always be able to achieve the same level of performance.

Read the following conditions carefully. Do not overly rely on this system and always drive carefully.

- Conditions under which the system may operate even if there is no possibility of a collision: →P. 241
- Conditions under which the system may not operate properly: →P. 244

- Do not attempt to test the operation of the pre-collision system yourself, as the system may not operate properly, possibly leading to an accident.

■ Pre-collision braking*³

- The pre-collision braking function may not operate if certain operations are performed by the driver. If the accelerator pedal is being depressed strongly or the steering wheel is being turned, the system may determine that the driver is taking evasive action and possibly prevent the pre-collision braking function from operating.

- In some situations, while the pre-collision braking function is operating, operation of the function may be canceled if the accelerator pedal is depressed strongly or the steering wheel is turned and the system determines that the driver is taking evasive action.

- A large amount of braking force is applied while the pre-collision braking function is operating. Additionally, as the vehicle may creep if it has been stopped by the pre-collision braking function, the driver should depress the brake pedal as necessary.

- If the brake pedal is being depressed, the system may determine that the driver is taking evasive action and possibly delay the operation timing of the pre-collision braking function.

*³: Depending on the region in which the vehicle was sold, the pre-collision braking function may not be available.

**WARNING****■ When to disable the pre-collision system**

In the following situations, disable the system, as it may not operate properly, possibly leading to an accident resulting in death or serious injury:

- When the vehicle is being towed
- When your vehicle is towing another vehicle
- When transporting the vehicle via truck, boat, train or similar means of transportation
- When the vehicle is raised on a lift with the engine running and the tires are allowed to rotate freely
- When inspecting the vehicle using a drum tester such as a chassis dynamometer or speedometer tester, or when using an on vehicle wheel balancer
- When a strong impact is applied to the front bumper or front grille, due to an accident or other reasons
- If the vehicle cannot be driven in a stable manner, such as when the vehicle has been in an accident or is malfunctioning
- When the vehicle is driven in a sporty manner or off-road
- When the tires are not properly inflated
- When the tires are very worn
- When tires of a size other than specified are installed
- When tire chains are installed
- When a spare tire or an emergency tire puncture repair kit is used
- If the suspension is modified
- If the front of the vehicle is raised or lowered, such as when loaded with heavy luggage

Changing settings of the pre-collision system

■ Enabling/disabling the pre-collision system

Press the PCS switch for 3 seconds or more.

The system is automatically enabled each time the engine switch is turned to IGNITION ON mode.

If the system is disabled, the PCS warning light will turn on and a message will be displayed on the multi-information display.

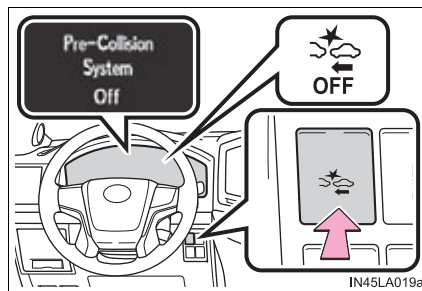

■ Changing the pre-collision warning timing

Press the PCS switch.

Each time the PCS switch is pressed, the warning timing changes as follows:

The operation timing setting is retained when the engine switch is turned off.

- ① Far
The warning will begin to operate earlier than with the default timing.
- ② Middle
This is the default setting.
- ③ Near
The warning will begin to operate later than with the default timing.

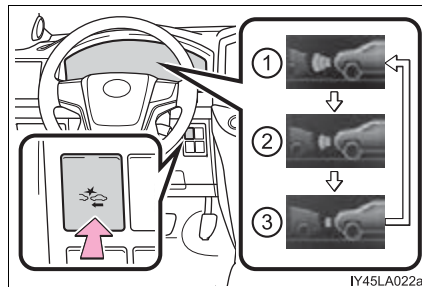

■ **Operational conditions**

- ▶ For vehicles sold in regions where the pedestrian detection function and pre-collision braking function are available ^{*4}

The pre-collision system is enabled and the system determines that the possibility of a frontal collision with a vehicle or pedestrian is high.

Each function is operational at the following speeds:

- Pre-collision warning:
 - Vehicle speed is approximately 7 mph (10 km/h) or more. (For detecting a pedestrian, vehicle speed is between approximately 7 and 50 mph (10 and 80 km/h).)
 - The relative speed between your vehicle and the vehicle or pedestrian ahead is approximately 7 mph (10 km/h) or more.
- Pre-collision brake assist:
 - Vehicle speed is approximately 19 mph (30 km/h) or more. (For detecting a pedestrian, vehicle speed is between approximately 19 and 50 mph (30 and 80 km/h).)
 - The relative speed between your vehicle and the vehicle or pedestrian ahead is approximately 19 mph (30 km/h) or more.
- Pre-collision braking:
 - Vehicle speed is approximately 7 mph (10 km/h) or more. (For detecting a pedestrian, vehicle speed is between approximately 7 and 50 mph (10 and 80 km/h).)
 - The relative speed between your vehicle and the vehicle or pedestrian ahead is approximately 7 mph (10 km/h) or more.

The system may not operate in the following situations:

- If a battery terminal has been disconnected and reconnected and then the vehicle has not been driven for a certain amount of time
- If the shift lever is in R
- If VSC is disabled (only the pre-collision warning function will be operational)
- If the PCS warning light is flashing or illuminated

- ▶ For vehicles sold in regions where the pedestrian detection function is not available and the pre-collision braking function is available*4

The pre-collision system is enabled and the system determines that the possibility of a frontal collision with a vehicle is high.

Each function is operational at the following speeds:

- Pre-collision warning:
 - Vehicle speed is approximately 10 mph (15 km/h) or more.
 - The relative speed between your vehicle and the vehicle or pedestrian ahead is approximately 7 mph (10 km/h) or more.
- Pre-collision brake assist:
 - Vehicle speed is approximately 19 mph (30 km/h) or more.
 - The relative speed between your vehicle and the vehicle or pedestrian ahead is approximately 19 mph (30 km/h) or more.
- Pre-collision braking:
 - Vehicle speed is approximately 10 mph (15 km/h) or more.
 - The relative speed between your vehicle and the vehicle or pedestrian ahead is approximately 7 mph (10 km/h) or more.

The system may not operate in the following situations:

- If a battery terminal has been disconnected and reconnected and then the vehicle has not been driven for a certain amount of time
- If the shift lever is in R
- If VSC is disabled (only the pre-collision warning function will be operational)
- If the PCS warning light is flashing or illuminated

- ▶ For vehicles sold in regions where the pedestrian detection function and pre-collision braking function are not available^{*4}

The pre-collision system is enabled and the system determines that the possibility of a frontal collision with a vehicle is high.

Each function is operational at the following speeds:

- Pre-collision warning:
 - Vehicle speed is approximately 10 mph (15 km/h) or more.
 - The relative speed between your vehicle and the vehicle or pedestrian ahead is approximately 7 mph (10 km/h) or more.
- Pre-collision brake assist:
 - Vehicle speed is approximately 19 mph (30 km/h) or more.
 - The relative speed between your vehicle and the vehicle or pedestrian ahead is approximately 19 mph (30 km/h) or more.

The system may not operate in the following situations:

- If a battery terminal has been disconnected and reconnected and then the vehicle has not been driven for a certain amount of time
- If the shift lever is in R
- If VSC is disabled (only the pre-collision warning function will be operational)
- If the PCS warning light is flashing or illuminated

^{*4}: Depending on the region in which the vehicle was sold, the pedestrian detection function and pre-collision braking function may not be available.

■ **Pedestrian detection function**^{*5}

The pre-collision system detects pedestrians based on the size, profile, and motion of a detected object. However, a pedestrian may not be detected depending on the surrounding brightness and the motion, posture, and angle of the detected object, preventing the system from operating properly. (→P. 246)



^{*5}: Depending on the region in which the vehicle was sold, the pedestrian detection function may not be available.

■ **Cancellation of the pre-collision braking**^{*3}

- If either of the following occur while the pre-collision braking function is operating, it will be canceled:
 - The accelerator pedal is depressed strongly.
 - The steering wheel is turned sharply or abruptly.
- If the vehicle is stopped by the operation of the pre-collision braking function, the operation of the pre-collision braking function will be canceled after the vehicle has been stopped for approximately 2 seconds.

^{*3}: Depending on the region in which the vehicle was sold, the pre-collision braking function may not be available.

■ **Conditions under which the system may operate even if there is no possibility of a collision**

- In some situations such as the following, the system may determine that there is a possibility of a frontal collision and operate.
 - When passing a vehicle or pedestrian^{*5}
 - When changing lanes while overtaking a preceding vehicle
 - When overtaking a preceding vehicle that is changing lanes
 - When overtaking a preceding vehicle that is making a left/right turn

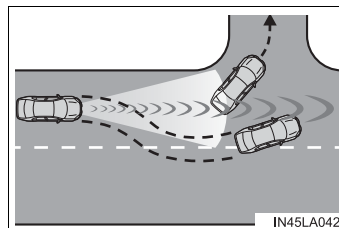

- When passing a vehicle in an oncoming lane that is stopped to make a right/left turn

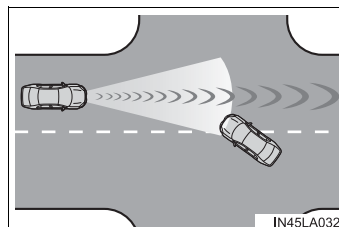

- When driving on a road where relative location to vehicle ahead in an adjacent lane may change, such as on a winding road

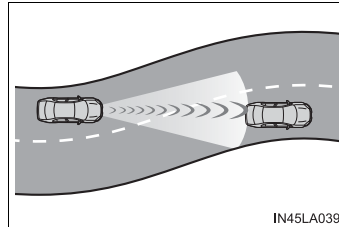

- When a preceding vehicle suddenly decelerates
- If the front of the vehicle is raised or lowered, such as when the road surface is uneven or undulating
- When approaching objects on the roadside, such as guardrails, utility poles, trees, or walls
- When there is a vehicle, pedestrian^{*5}, or object by the roadside at the entrance of a curve

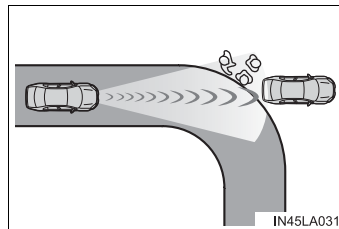

- When driving on a narrow path surrounded by a structure, such as in a tunnel or on an iron bridge
- When there is a metal object (manhole cover, steel plate, etc.), steps, or a protrusion on the road surface or roadside
- When a crossing pedestrian approaches very close to the vehicle^{*5}

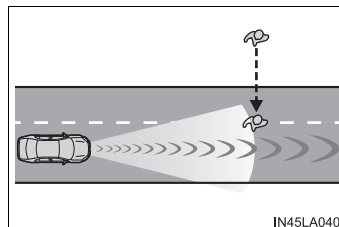

- When passing through a place with a low structure above the road (low ceiling, traffic sign, etc.)

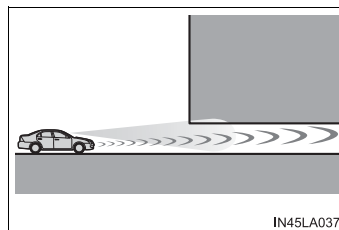

- When passing under an object (billboard, etc.) at the top of an uphill road

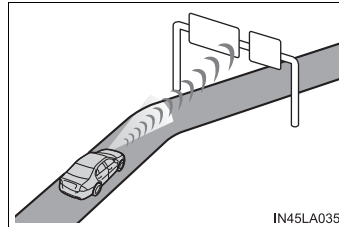

- When rapidly closing on an electric toll gate barrier, parking area barrier, or other barrier that opens and closes
- When using an automatic car wash
- When driving through or under objects that may contact the vehicle, such as thick grass, tree branches, or a banner

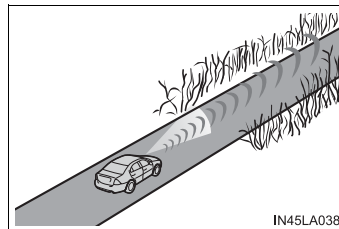

- When the vehicle is hit by water, snow, dust, etc. from a vehicle ahead
- When driving through steam or smoke
- When there are patterns or paint on the road or a wall that may be mistaken for a vehicle or pedestrian^{*5}
- When driving near an object that reflects radio waves, such as a large truck or guardrail
- When driving near a TV tower, broadcasting station, electric power plant, or other location where strong radio waves or electrical noise may be present

^{*5}: Depending on the region in which the vehicle was sold, the pedestrian detection function may not be available.

■ **Situations in which the system may not operate properly**

● In some situations such as the following, a vehicle may not be detected by the radar sensor and camera sensor, preventing the system from operating properly:

- If an oncoming vehicle is approaching your vehicle
- If a vehicle ahead is a motorcycle or bicycle
- When approaching the side of a vehicle
- If a preceding vehicle has a small rear end, such as an unloaded truck
- If a preceding vehicle has a low rear end, such as a low bed trailer

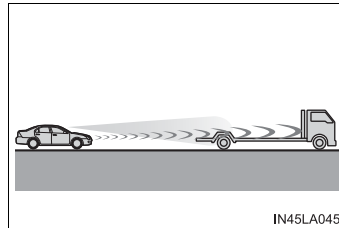

- If a vehicle ahead is carrying a load which protrudes past its rear bumper
- If a vehicle ahead has extremely high ground clearance

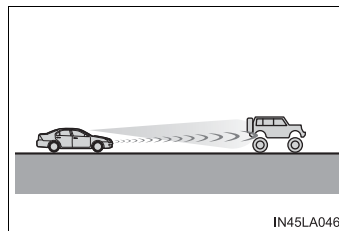

- If a vehicle ahead is irregularly shaped, such as a tractor or side car
- If the sun or other light is shining directly on a vehicle ahead
- If a vehicle cuts in front of your vehicle or emerges from beside a vehicle
- If a vehicle ahead makes an abrupt maneuver (such as sudden swerving, acceleration or deceleration)
- When suddenly cutting behind a preceding vehicle
- When a vehicle ahead is not directly in front of your vehicle

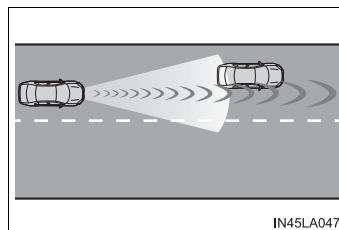

- When driving in inclement weather such as heavy rain, fog, snow or a sandstorm
- When the vehicle is hit by water, snow, dust, etc. from a vehicle ahead
- When driving through steam or smoke
- When driving in a place where the surrounding brightness changes suddenly, such as at the entrance or exit of a tunnel

- When a very bright light, such as the sun or the headlights of oncoming traffic, shines directly into the camera sensor
- When the surrounding area is dim, such as at dawn or dusk, or while at night or in a tunnel
- After the engine has started the vehicle has not been driven for a certain amount of time
- While making a left/right turn and for a few seconds after making a left/right turn
- While driving on a curve and for a few seconds after driving on a curve
- If your vehicle is skidding
- If the front of the vehicle is raised or lowered, such as when the road surface is uneven or undulating
- If the wheels are misaligned
- If a wiper blade is blocking the camera sensor
- The vehicle is wobbling.
- The vehicle is being driven at extremely high speeds.
- When driving on a hill
- In some situations such as the following, sufficient braking force may not be obtained, preventing the system from performing properly:
 - If the braking functions cannot operate to their full extent, such as when the brake parts are extremely cold, extremely hot, or wet
 - If the vehicle is not properly maintained (brakes or tires are excessively worn, improper tire inflation pressure, etc.)
 - When the vehicle is being driven on a gravel road or other slippery surface

- Some pedestrians such as the following may not be detected by the radar sensor and camera sensor, preventing the system from operating properly^{*5}:
 - Pedestrians shorter than approximately 3.2 ft. (100 cm) or taller than approximately 6.5 ft. (2 m)
 - Pedestrians wearing oversized clothing (a rain coat, long skirt, etc.), making their silhouette obscure
 - Pedestrians who are carrying large baggage, holding an umbrella, etc., hiding part of their body
 - Pedestrians who are bending forward or squatting
 - Pedestrians who are pushing a stroller, wheelchair, bicycle or other vehicle
 - Groups of pedestrians which are close together
 - Pedestrians who are wearing white and look extremely bright
 - Pedestrians in the dark, such as at night or while in a tunnel
 - Pedestrians whose clothing appears to be nearly the same color or brightness as their surroundings
 - Pedestrians near walls, fences, guardrails, or large objects
 - Pedestrians who are on a metal object (manhole cover, steel plate, etc.) on the road
 - Pedestrians who are walking fast
 - Pedestrians who are changing speed abruptly
 - Pedestrians running out from behind a vehicle or a large object
 - Pedestrians who are extremely close to the side of the vehicle (outside rear view mirror, etc.)

^{*5}: Depending on the region in which the vehicle was sold, the pedestrian detection function may not be available.

■ If the PCS warning light flashes and a warning message is displayed on the multi-information display

The pre-collision system may be temporarily unavailable or there may be a malfunction in the system.

- In the following situations, the warning light will turn off, the message will disappear and the system will become operational when normal operating conditions return:
 - When the radar sensor or camera sensor or the area around either sensor is hot, such as in the sun
 - When the radar sensor or camera sensor or the area around either sensor is cold, such as in an extremely cold environment
 - When the radar sensor or front grille emblem is dirty or covered with snow, etc.
 - If the camera sensor is obstructed, such as when the hood is open or a sticker is attached to the windshield near the camera sensor
- If the PCS warning light continues to flash or the warning message does not disappear, the system may be malfunctioning. Have the vehicle inspected by your Toyota dealer immediately.

■ If VSC is disabled

- If VSC is disabled (→P. 359), the pre-collision brake assist and pre-collision braking functions are also disabled.
- The PCS warning light will turn on and “VSC Turned Off Pre-collision Brake System Unavailable” will be displayed on the multi-information display.

LDA (Lane Departure Alert)*

Summary of functions

When driving on highways and freeways with white (yellow) lines, this function alerts the driver when the vehicle might depart from its lane.

The LDA system recognizes visible white (yellow) lines with the camera sensor on the upper portion of the front windshield.

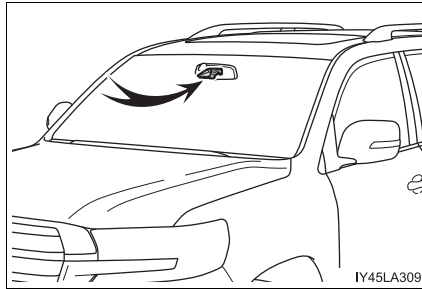

Functions included in LDA system

◆ Lane departure alert function

When the system determines that the vehicle might depart from its lane, a warning is displayed on the multi-information display and the warning buzzer sounds to alert the driver.

When the warning buzzer sounds or the steering wheel vibrates, check the surrounding road situation and carefully operate the steering wheel to move the vehicle back to the center within the white (yellow) lines.

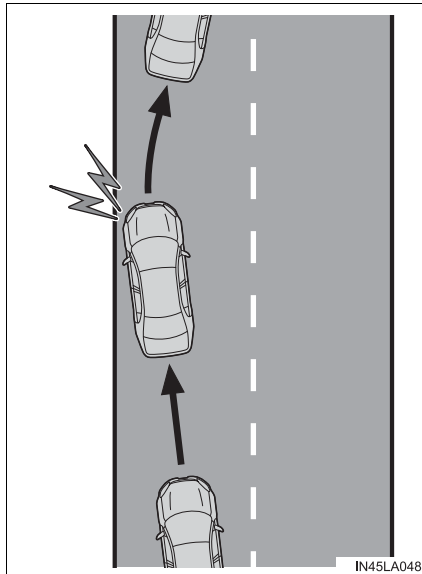

*: If equipped

◆ Vehicle sway warning

When the vehicle is swaying or appears as if it may depart from its lane multiple times, the warning buzzer sounds and a message is displayed on the multi-information display to alert the driver.

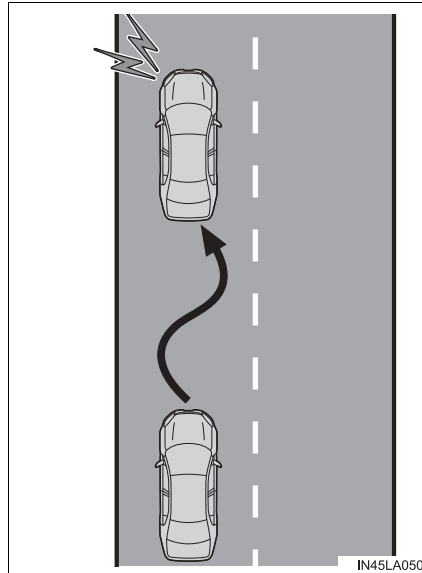

4

Driving

⚠ WARNING

■ Before using LDA system

Do not rely solely upon the LDA system. LDA is not a system which automatically drives the vehicle or reduces the amount of attention that must be paid to the area in front of the vehicle. The driver must always assume full responsibility for driving safely by always paying careful attention to the surrounding conditions and operate the steering wheel to correct the path of the vehicle. Also, make sure to take adequate breaks when fatigued, such as from driving for a long period of time.

Failure to perform appropriate driving operations and pay careful attention may lead to an accident, resulting in death or serious injury.

 **WARNING**

■ **To avoid operating LDA by mistake**

When not using the LDA system, use the LDA switch to turn the system off.

■ **Situations unsuitable for LDA**

Do not use the LDA system in the following situations.

The system may not operate properly and lead to an accident, resulting in death or serious injury.

- A spare tire, tire chains, etc., are equipped.
- Objects or patterns that could be mistaken for white (yellow) lines are present on the side of the road (guardrails, curbs and reflective poles, etc.).
- Vehicle is driven on a snow-covered road.
- White (yellow) lines are difficult to see due to rain, snow, fog, dust, etc.
- Asphalt repair marks, white (yellow) line marks, etc., are present due to road repair.
- Vehicle is driven in a temporary lane or restricted lane due to construction work.
- Vehicle is driven in a construction zone.

■ **Preventing LDA system malfunctions and operations performed by mistake**

- Do not modify the headlights or place stickers, etc., on the surface of the lights.
- Do not modify the suspension or use parts other than genuine replacement parts.
- Do not install or place anything on the hood or grille. Also, do not install a grille guard (bull bars, kangaroo bar, etc.).
- If your windshield needs repairs, contact your Toyota dealer.

Turning LDA system on

Press the LDA switch to turn the LDA system on.

The LDA indicator illuminates.

Press the LDA switch again to turn the LDA system off.

When the LDA system is turned on or off, operation of the LDA system continues in the same condition the next time the engine is started.

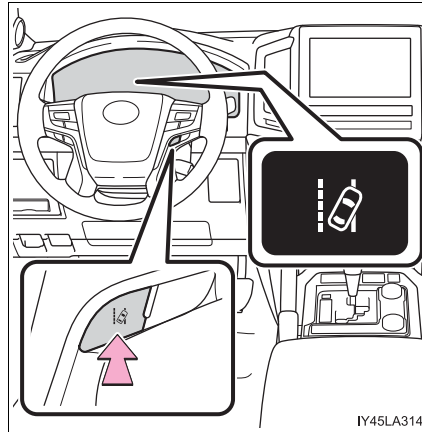

Indications on multi-information display

Lane departure alert function display

Displayed when the multi-information display is switched to the driving assist system information screen.



► Inside of displayed white lines is white

► Inside of displayed white lines is black



Indicates that the system is recognizing white (yellow) lines. When the vehicle departs from its lane, the white line displayed on the side the vehicle departs from flashes orange.



Indicates that the system is not able to recognize white (yellow) lines or is temporarily canceled.

■ Operation conditions of each function**● Lane departure alert function**

This function operates when all of the following conditions are met.

- LDA is turned on.
- Vehicle speed is approximately 32 mph (50 km/h) or more.
- System recognizes white (yellow) lines.
- Width of traffic lane is approximately 9.8 ft. (3 m) or more.
- Turn signal lever is not operated.
- Vehicle is driven on a straight road or around a gentle curve with a radius of more than approximately 492 ft. (150 m).
- No system malfunctions are detected. (→P. 255)

● Vehicle sway warning

This function operates when all of the following conditions are met.

- Setting for “Sway Warning” in “Settings display” of the multi-information display is set to “On”. (→P. 574)
- Vehicle speed is approximately 32 mph (50 km/h) or more.
- Width of traffic lane is approximately 9.8 ft. (3 m) or more.
- No system malfunctions are detected. (→P. 255)

■ Temporary cancellation of functions

When operation conditions are no longer met, a function may be temporarily canceled. However, when the operation conditions are met again, operation of the function is automatically restored. (→P. 253)

■ Lane departure alert function

The warning buzzer may be difficult to hear due to external noise, audio playback, etc.

■ White (yellow) lines are only on one side of road

The LDA system will not operate for the side on which white (yellow) lines could not be recognized.

■ Conditions in which functions may not operate properly

In the following situations, the camera sensor may not detect white (yellow) lines and various functions may not operate normally.

- There are shadows on the road that run parallel with, or cover, the white (yellow) lines.
- The vehicle is driven in an area without white (yellow) lines, such as in front of a tollgate or checkpoint, or at an intersection, etc.
- The white (yellow) lines are cracked, or “Botts’ dots”, “Raised pavement marker” or stones are present.
- The white (yellow) lines cannot be seen or are difficult to see due to sand, etc.
- The vehicle is driven on a road surface that is wet due to rain, puddles, etc.
- The traffic lines are yellow (which may be more difficult to recognize than lines that are white).
- The white (yellow) lines cross over a curb, etc.
- The vehicle is driven on a bright surface, such as concrete.
- The vehicle is driven on a surface that is bright due to reflected light, etc.
- The vehicle is driven in an area where the brightness changes suddenly, such as at the entrances and exits of tunnels, etc.
- Light from the headlights of an oncoming vehicle, the sun, etc., enters the camera.
- The vehicle is driven where the road diverges, merges, etc.
- The vehicle is driven on a slope.
- The vehicle is driven on a road which tilts left or right, or a winding road.
- The vehicle is driven on an unpaved or rough road.
- The vehicle is driven around a sharp curve.
- The traffic lane is excessively narrow or wide.
- The vehicle is extremely tilted due to carrying heavy luggage or having improper tire pressure.
- The distance to the preceding vehicle is extremely short.
- The vehicle is moving up and down a large amount due to road conditions during driving (poor roads or road seams).
- The headlight lenses are dirty and emit a faint amount of light at night, or the beam axis has deviated.
- The vehicle is struck by a crosswind.
- The vehicle has just changed lanes or crossed an intersection.

■ **Warning message**

If the following warning message is displayed on the multi-information display and the LDA indicator turns off, follow the appropriate troubleshooting procedure.

Warning message	Details/Actions
“Lane Departure Alert Malfunction Visit Your Dealer”	The system may not be operating properly. → Have the vehicle inspected at your Toyota dealer.
“Forward Camera System Unavailable Clean Windshield”	Dirt, rain, condensation, ice, snow, etc., are present on the windshield in front of the camera sensor. → Turn the LDA system off, remove any dirt, rain, condensation, ice, snow, etc., from the windshield, and then turn the LDA system back on.
“Forward Camera System Unavailable”	The LDA system is temporarily canceled due to high temperatures around the camera sensor. → Turn the LDA system off, wait for the area around the camera sensor to cool, and then turn the LDA system back on.
“Lane Departure Alert Unavailable”	The LDA system is temporarily canceled due to a malfunction in a sensor other than the camera sensor. → Turn the LDA system off and follow the appropriate troubleshooting procedures for warning message. Afterward, drive the vehicle for a short time, and then turn the LDA system back on.
“Lane Departure Alert Unavailable Below Approx 32 MPH”	The LDA system cannot be used as the vehicle speed is approximately 32 mph (50 km/h) or less. → Drive the vehicle at approximately 32 mph (50 km/h) or more.

If a different warning message is displayed, follow the instructions displayed on the screen.

■ Customization

The following settings can be changed.

Function	Setting details
Lane departure alert	Adjust alert sensitivity
Vehicle sway warning	Turn function on and off
	Adjust alert sensitivity

For how to change settings, refer to P. 574.

Dynamic radar cruise control*

Summary of functions

In vehicle-to-vehicle distance control mode, the vehicle automatically accelerates and decelerates to match the speed changes of the preceding vehicle even if the accelerator pedal is not depressed. In constant speed control mode, the vehicle runs at a fixed speed.

Use the dynamic radar cruise control on freeways and highways.

- Vehicle-to-vehicle distance control mode (→P. 260)
- Constant speed control mode (→P. 265)

- ① Indicators
- ② Display
- ③ Set speed
- ④ Vehicle-to-vehicle distance button
- ⑤ Cruise control switch

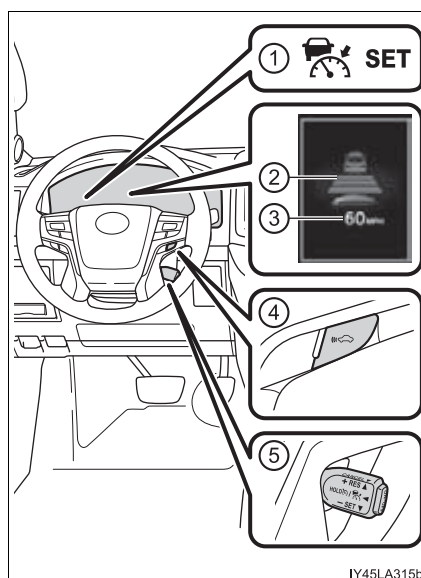

4

Driving

*: If equipped

 **WARNING****■ Before using dynamic radar cruise control**

Driving safely is the sole responsibility of the driver. Do not rely solely on the system, and drive safely by always paying careful attention to your surroundings.

The dynamic radar cruise control with full-speed range provides driving assistance to reduce the driver's burden. However, there are limitations to the assistance provided.

Even when the system is functioning normally, the condition of the preceding vehicle as detected by the system may differ from the condition observed by the driver. Therefore, the driver must always remain alert, assess the danger of each situation and drive safely. Relying on this system or assuming the system ensures safety while driving can lead to an accident, resulting in death or serious injury.

■ Cautions regarding the driving assist systems

Observe the following precautions, as there are limitations to the assistance provided by the system.

Failure to do so may cause an accident resulting in death or serious injury.

● Assisting the driver to measure following distance

The dynamic radar cruise control is only intended to help the driver in determining the following distance between the driver's own vehicle and a designated vehicle traveling ahead. It is not a mechanism that allows careless or inattentive driving, and it is not a system that can assist the driver in low-visibility conditions. It is still necessary for driver to pay close attention to the vehicle's surroundings.

● Assisting the driver to judge proper following distance

The dynamic radar cruise control determines whether the following distance between the driver's own vehicle and a designated vehicle traveling ahead is within a set range. It is not capable of making any other type of judgement. Therefore, it is absolutely necessary for the driver to remain vigilant and to determine whether or not there is a possibility of danger in any given situation.

● Assisting the driver to operate the vehicle

The dynamic radar cruise control has limited capability to prevent or avoid a collision with a vehicle traveling ahead. Therefore, if there is ever any danger, the driver must take immediate and direct control of the vehicle and act appropriately in order to ensure the safety of all involved.

■ To avoid inadvertent dynamic radar cruise control activation

Switch the dynamic radar cruise control off using the "ON/OFF" button when not in use.

 **WARNING****■ Situations unsuitable for dynamic radar cruise control**

Do not use dynamic radar cruise control in any of the following situations. Doing so may result in inappropriate speed control and could cause an accident resulting in death or serious injury.

- Roads where there are pedestrians, cyclists, etc.
- In heavy traffic
- On roads with sharp bends
- On winding roads
- On slippery roads, such as those covered with rain, ice or snow
- On steep downhills, or where there are sudden changes between sharp up and down gradients
Vehicle speed may exceed the set speed when driving down a steep hill.
- At entrances to freeways and highways
- When weather conditions are bad enough that they may prevent the sensors from detecting correctly (fog, snow, sandstorm, heavy rain, etc.)
- When there is rain, snow, etc. on the front surface of the radar sensor or camera sensor
- In traffic conditions that require frequent repeated acceleration and deceleration
- When your vehicle is towing a trailer or during emergency towing
- When an approach warning buzzer is heard often

Driving in vehicle-to-vehicle distance control mode

This mode employs a radar sensor to detect the presence of vehicles up to approximately 400 ft. (120 m) ahead, determines the current vehicle-to-vehicle following distance, and operates to maintain a suitable following distance from the vehicle ahead.

Note that vehicle-to-vehicle distance will close in when traveling on long downhill slopes.

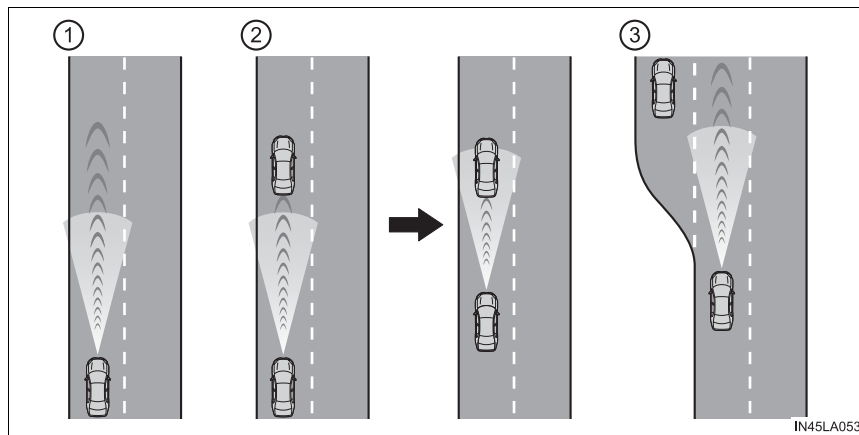

① Example of constant speed cruising

When there are no vehicles ahead

The vehicle travels at the speed set by the driver. The desired vehicle-to-vehicle distance can also be set by operating the vehicle-to-vehicle distance button.

② Example of deceleration cruising and follow-up cruising

When a preceding vehicle driving slower than the set speed appears

When a vehicle is detected running ahead of you, the system automatically decelerates your vehicle. When a greater reduction in vehicle speed is necessary, the system applies the brakes (the stop lights will come on at this time). The system will respond to changes in the speed of the vehicle ahead in order to maintain the vehicle-to-vehicle distance set by the driver. Approach warning warns you when the system cannot decelerate sufficiently to prevent your vehicle from closing in on the vehicle ahead.

③ Example of acceleration

When there are no longer any preceding vehicles driving slower than the set speed

The system accelerates until the set speed is reached. The system then returns to constant speed cruising.

Setting the vehicle speed (vehicle-to-vehicle distance control mode)

- 1 Press the “ON/OFF” button to activate the cruise control.

Radar cruise control indicator will come on and a message will be displayed on the multi-information display.

Press the button again to deactivate the cruise control.

If the “ON/OFF” button is pressed and held for 1.5 seconds or more, the system turns on in constant speed control mode. (→P. 265)

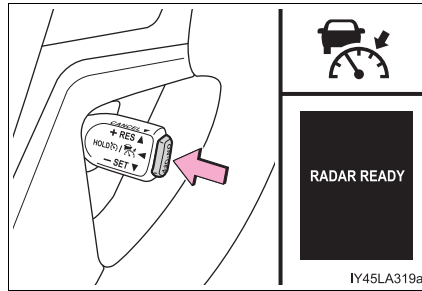

- 2 Accelerate or decelerate, with accelerator pedal operation, to the desired vehicle speed (above approximately 30 mph [50 km/h]) and push the lever down to set the speed.

Cruise control “SET” indicator will come on.

The vehicle speed at the moment the lever is released becomes the set speed.

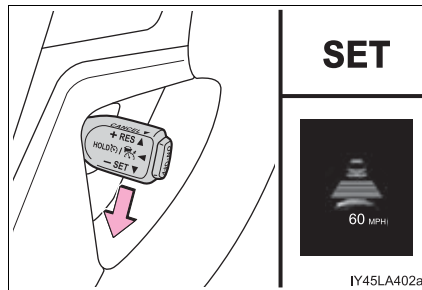

Adjusting the set speed

To change the set speed, operate the lever until the desired set speed is displayed.

- ① Increases the speed
- ② Decreases the speed

Fine adjustment: Momentarily move the lever in the desired direction.

Large adjustment: Hold the lever up or down to change the speed, and release when the desired speed is reached.

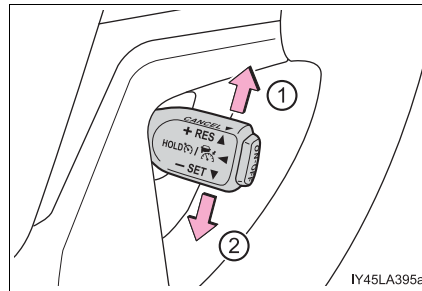

In the vehicle-to-vehicle distance control mode, the set speed will be increased or decreased as follows:

Fine adjustment: By 1 mph (1.6 km/h)^{*1} or 1 km/h (0.6 mph)^{*2} each time the lever is operated

Large adjustment: Increases or decreases in 5 km/h (3.1 mph)^{*1} or 5 mph (8 km/h)^{*2} increments for as long as the lever is held

In the constant speed control mode (→P. 265), the set speed will be increased or decreased as follows:

Fine adjustment: By 1 mph (1.6 km/h)^{*1} or 1 km/h (0.6 mph)^{*2} each time the lever is operated

Large adjustment: The speed will continue to change while the lever is held.

*1: When the set speed is shown in "MPH"

*2: When the set speed is shown in "km/h"

Changing the vehicle-to-vehicle distance (vehicle-to-vehicle distance control mode)

Pressing the button changes the vehicle-to-vehicle distance as follows:

- ① Long
- ② Medium
- ③ Short

The vehicle-to-vehicle distance is set automatically to long mode when the engine switch is turned to IGNITION ON mode.

If a vehicle is running ahead of you, the preceding vehicle mark will also be displayed.

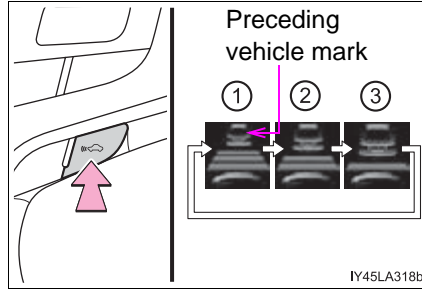

Vehicle-to-vehicle distance settings (vehicle-to-vehicle distance control mode)

Select a distance from the table below. Note that the distances shown correspond to a vehicle speed of 50 mph (80 km/h). Vehicle-to-vehicle distance increases/decreases in accordance with vehicle speed.

Distance options	Vehicle-to-vehicle distance
Long	Approximately 160 ft. (50 m)
Medium	Approximately 130 ft. (40 m)
Short	Approximately 100 ft. (30 m)

Canceling and resuming the speed control

- ① Pulling the lever toward you cancels the speed control.
The speed control is also canceled when the brake pedal is depressed.
- ② Pushing the lever up resumes the cruise control and returns vehicle speed to the set speed.

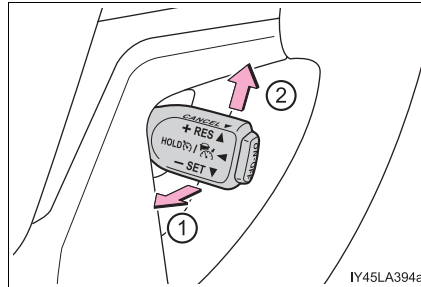

However, cruise control does not resume when the vehicle speed is approximately 25 mph (40 km/h) or less.

Approach warning (vehicle-to-vehicle distance control mode)

When your vehicle is too close to a vehicle ahead, and sufficient automatic deceleration via the cruise control is not possible, the display will flash and the buzzer will sound to alert the driver. An example of this would be if another driver cuts in front of you while you are following a vehicle. Depress the brake pedal to ensure an appropriate vehicle-to-vehicle distance.

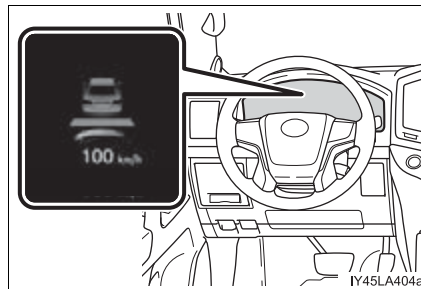

■ Warnings may not occur when

In the following instances, warnings may not occur even when the vehicle-to-vehicle distance is small.

- When the speed of the preceding vehicle matches or exceeds your vehicle speed
- When the preceding vehicle is traveling at an extremely slow speed
- Immediately after the cruise control speed was set
- When depressing the accelerator pedal

Selecting constant speed control mode

When constant speed control mode is selected, your vehicle will maintain a set speed without controlling the vehicle-to-vehicle distance. Select this mode only when vehicle-to-vehicle distance control mode does not function correctly due to a dirty radar sensor, etc.

- 1 With the cruise control off, press and hold the “ON/OFF” button for 1.5 seconds or more.

Immediately after the “ON/OFF” button is pressed, the radar cruise control indicator will come on. Afterwards, it switches to the cruise control indicator.

Switching to constant speed control mode is only possible when operating the lever with the cruise control off.

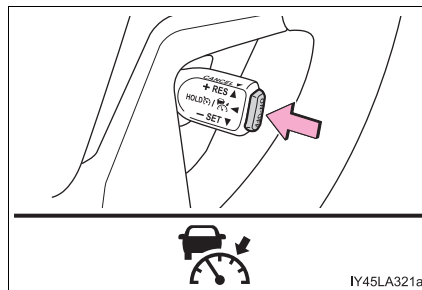

IY45LA321a

- 2 Accelerate or decelerate, with accelerator pedal operation, to the desired vehicle speed (above approximately 32 mph [50 km/h]) and push the lever down to set the speed.

Cruise control “SET” indicator will come on.

The vehicle speed at the moment the lever is released becomes the set speed.

Adjusting the speed setting: →P. 262

Canceling and resuming the speed setting: →P. 264

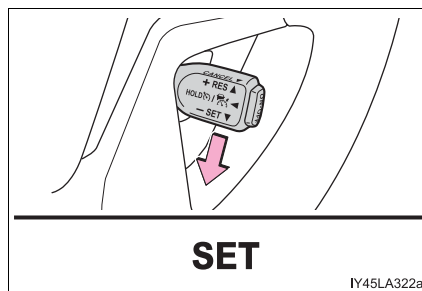

IY45LA322a

■ **Dynamic radar cruise control can be set when**

- The shift lever is in D or range 4 or higher of S has been selected.
- Vehicle speed is above approximately 30 mph (50 km/h).

■ **Accelerating after setting the vehicle speed**

The vehicle can accelerate by operating the accelerator pedal. After accelerating, the set speed resumes. However, during vehicle-to-vehicle distance control mode, the vehicle speed may decrease below the set speed in order to maintain the distance to the preceding vehicle.

■ **Automatic cancelation of vehicle-to-vehicle distance control mode**

Vehicle-to-vehicle distance control mode is automatically canceled in the following situations.

- Actual vehicle speed falls below approximately 25 mph (40 km/h).
- VSC is activated.
- Active TRAC is activated for a period of time.
- When the VSC or Active TRAC system is turned off by pressing the VSC OFF switch.
- The sensor cannot detect correctly because it is covered in some way.
- Pre-collision braking is activated.

If vehicle-to-vehicle distance control mode is automatically canceled for any other reason, there may be a malfunction in the system. Contact your Toyota dealer.

■ Automatic cancelation of constant speed control mode

Constant speed control mode is automatically canceled in the following situations:

- Actual vehicle speed is more than approximately 10 mph (16 km/h) below the set vehicle speed.
- Actual vehicle speed falls below approximately 25 mph (40 km/h).
- VSC is activated.
- Active TRAC is activated for a period of time.
- When the VSC or Active TRAC system is turned off by pressing the VSC OFF switch.
- Pre-collision braking is activated.

If vehicle-to-vehicle distance control mode is automatically canceled for any other reason, there may be a malfunction in the system. Contact your Toyota dealer.

■ Warning messages and buzzers for dynamic radar cruise control

Warning messages and buzzers are used to indicate a system malfunction or to inform the driver of the need for caution while driving. If a warning message is shown on the multi-information display, read the message and follow the instructions.

■ When the sensor may not be correctly detecting the vehicle ahead

In the case of the following and depending on the conditions, operate the brake pedal when deceleration of the system is insufficient or operate the accelerator pedal when acceleration is required.

As the sensor may not be able to correctly detect these types of vehicles, the approach warning (→P. 264) may not be activated.

- Vehicles that cut in suddenly
- Vehicles traveling at low speeds
- Vehicles that are not moving in the same lane
- Vehicles with small rear ends (trailers with no load on board, etc.)

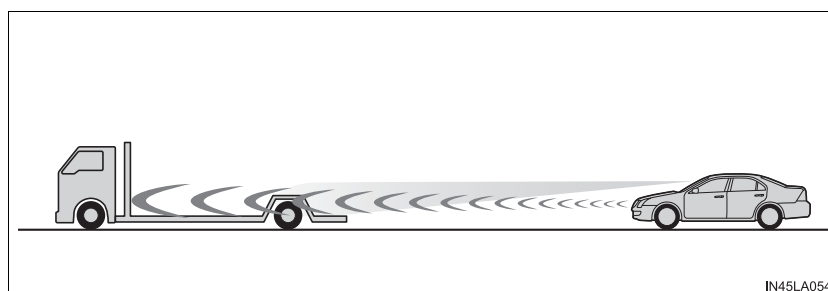

- Motorcycles traveling in the same lane
- When water or snow thrown up by the surrounding vehicles hinders the detecting of the sensor

- When your vehicle is pointing upwards (caused by a heavy load in the luggage compartment, etc.)

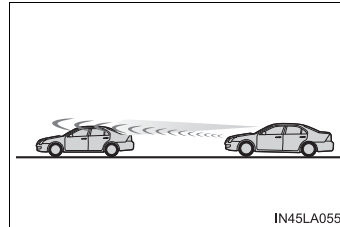

- Preceding vehicle has an extremely high ground clearance

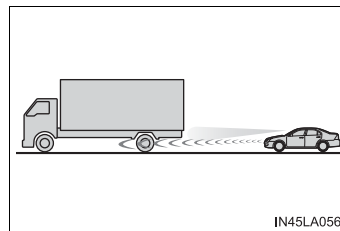

■ **Conditions under which the vehicle-to-vehicle distance control mode may not function correctly**

In the case of the following conditions, operate the brake pedal (or accelerator pedal, depending on the situation) as necessary. As the sensor may not be able to correctly detect vehicles ahead, the system may not operate properly.

- When the road curves or when the lanes are narrow

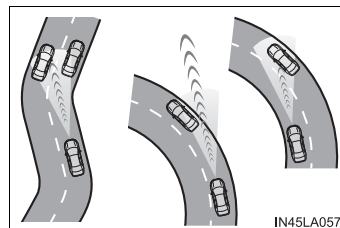

- When steering wheel operation or your position in the lane is unstable

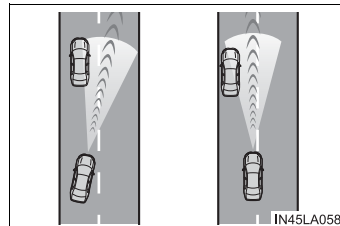

- When the vehicle ahead of you decelerates suddenly

Cruise control*

Summary of functions

Use the cruise control to maintain a set speed without depressing the accelerator pedal.

- ① Indicators
- ② Cruise control switch

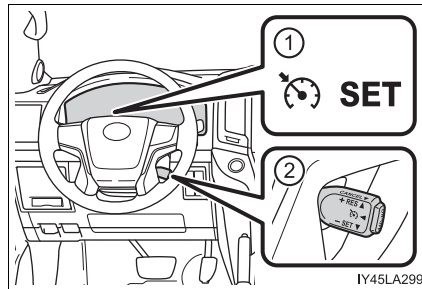

Setting the vehicle speed

- 1 Press the “ON-OFF” button to activate the cruise control.
Cruise control indicator will come on.
Press the button again to deactivate the cruise control.

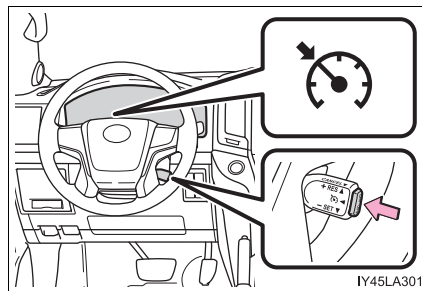

- 2 Accelerate or decelerate the vehicle to the desired speed, and push the lever down to set the speed.
“SET” indicator will come on.
The vehicle speed at the moment the lever is released becomes the set speed.

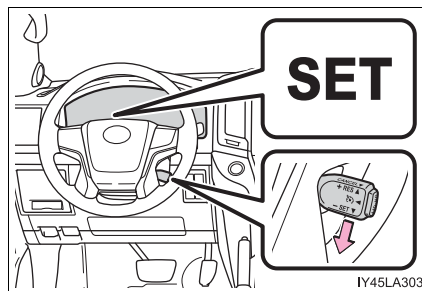

4

Driving

*: If equipped

Adjusting the set speed

To change the set speed, operate the lever until the desired set speed is obtained.

- ① Increases the speed
- ② Decreases the speed

Fine adjustment: Momentarily move the lever in the desired direction.

Large adjustment: Hold the lever in the desired direction.

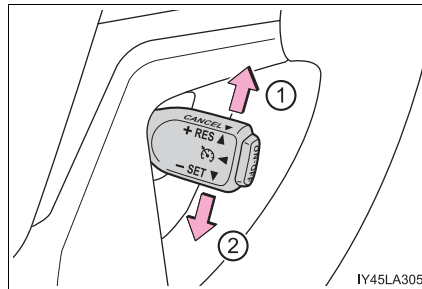

The set speed will be increased or decreased as follows:

Fine adjustment: By approximately 1 mph (1.6 km/h) each time the lever is operated.

Large adjustment: The set speed can be increased or decreased continually until the lever is released.

Canceling and resuming the constant speed control

- ① Pulling the lever toward you cancels the constant speed control.

The speed setting is also canceled when the brakes are applied.

- ② Pushing the lever up resumes the constant speed control.

Resuming is available when the vehicle speed is more than approximately 25 mph (40 km/h).

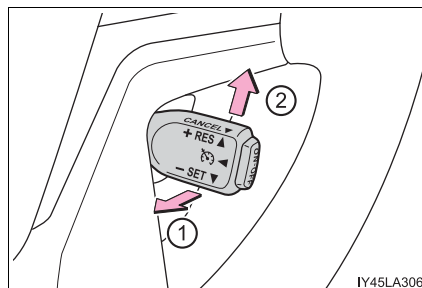

■ Cruise control can be set when

- The shift lever is in the D or range 4 or higher of S has been selected.
- Vehicle speed is above approximately 25 mph (40 km/h).

■ Accelerating after setting the vehicle speed

- The vehicle can be accelerated normally. After acceleration, the set speed resumes.
- Even without canceling the cruise control, the set speed can be increased by first accelerating the vehicle to the desired speed and then pushing the lever down to set the new speed.

■ **Automatic cruise control cancelation**

Cruise control will stop maintaining the vehicle speed in any of the following situations:

- Actual vehicle speed falls more than approximately 10 mph (16 km/h) below the preset vehicle speed.
At this time, the memorized set speed is not retained.
- Actual vehicle speed is below approximately 25 mph (40 km/h).
- VSC is activated.
- The center differential lock/unlock is not completed within 5 seconds while the cruise control system is on.

■ **If “Cruise Control Malfunction Visit Your Dealer” is shown on the multi-information display**

Press the “ON-OFF” button once to deactivate the system, and then press the button again to reactivate the system.

If the cruise control speed cannot be set or if the cruise control cancels immediately after being activated, there may be a malfunction in the cruise control system. Have the vehicle inspected by your Toyota dealer.

 **WARNING**

■ **To avoid operating the cruise control by mistake**

Switch the cruise control off using the “ON-OFF” button when not in use.

■ **Situations unsuitable for cruise control**

Do not use cruise control in any of the following situations. Doing so may result in loss of control and could cause an accident resulting in death or serious injury.

- In heavy traffic
- On roads with sharp bends
- On winding roads
- On slippery roads, such as those covered with rain, ice or snow
- On steep hills
Vehicle speed may exceed the set speed when driving down a steep hill.
- When your vehicle is towing a trailer (with towing hitch) or during emergency towing

Intuitive parking assist

The distance from your vehicle to nearby obstacles when parallel parking or maneuvering into a garage is measured by the sensors and communicated via the multi-information display, the multimedia screen (if equipped), the navigation system screen (if equipped), and a buzzer. Always check the surrounding area when using this system.

Types of sensors

- ① Front corner sensors
- ② Rear corner sensors
- ③ Rear center sensors

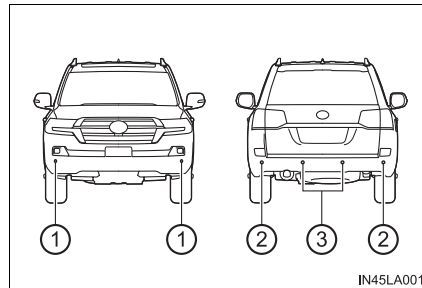

IN45LA001

Intuitive parking assist switch

On/off

To turn the system on, press the switch. The indicator light comes on and the buzzer sounds to inform the driver that the system is operational.

To turn the system off, press the switch again.

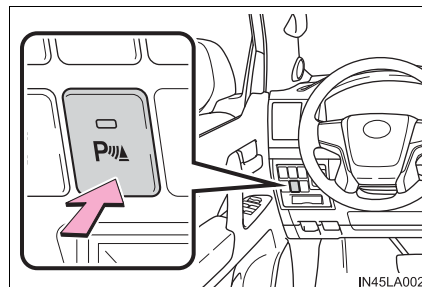

IN45LA002

Display

When the sensors detect an obstacle, a graphic is shown on the multi-information display, navigation system screen depending on the position and distance to the obstacle.

► Multi-information display

- ① Front corner sensor operation
- ② Rear corner sensor operation
- ③ Rear center sensor operation

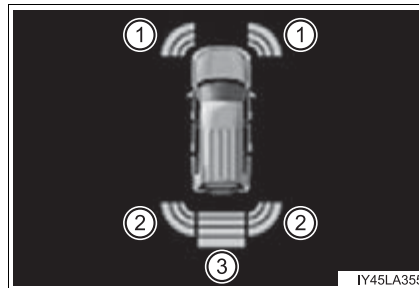

► Navigation system screen

- ① Intuitive parking assist display

When the Multi-terrain Monitor is not displayed.

A graphic is automatically displayed when an obstacle is detected. The screen can be set so that the graphic is not displayed. (→P. 276)

 : Select to mute the buzzer sounds.

- ② Intuitive parking assist
- ③ Rear Cross Traffic Alert (if equipped)

When the Multi-terrain Monitor is displayed.













A simplified image is displayed on the upper corner of the screen when an obstacle is detected.



Sensor detection display, obstacle distance

■ **Distance display**

Sensors that detect an obstacle will illuminate continuously or blink.

Multi-information display	Navigation system screen	Insert display	Approximate distance to obstacle	
			Corner sensor	Rear center sensor
 (continuous)	 (continuous)	 (blinking slowly)	—	4.9 ft. (150 cm) to 2.6 ft. (80 cm)
 (continuous)	 (continuous)	 (blinking)	2.0 ft. (60 cm) to 1.5 ft. (45 cm)	2.6 ft. (80 cm) to 2.1 ft. (65 cm)
 (continuous)	 (continuous)	 (blinking rapidly)	1.5 ft. (45 cm) to 1.1 ft. (35 cm)	2.1 ft. (65 cm) to 1.6 ft. (50 cm)
 (blinking)	 (continuous)	 (continuous)	Less than 1.1ft. (35 cm)	Less than 1.6 ft (50 cm).

■ Buzzer operation and distance to an obstacle

A buzzer sounds when the sensors are operating.

- The buzzer sounds faster as the vehicle approaches an obstacle. When the vehicle comes within the following distance of the obstacle, the buzzer sounds continuously.
 - Corner sensors: Approximately 1.1ft. (35 cm)
 - Rear center sensors: Approximately 1.3 ft. (50 cm)
- When 2 or more obstacles are detected simultaneously, the buzzer system responds to the nearest obstacle. If one or both come within the above distances, the beep will repeat a long tone, followed by fast beeps.
- You can change the volume of the warning beeps. (→P. 276)

Detection range of the sensors

- ① Approximately 4.9 ft. (150 cm)
- ② Approximately 2.0 ft. (60 cm)
- ③ Approximately 2.0 ft. (60 cm)

The diagram shows the detection range of the sensors. Note that the sensors may not be able to detect obstacles that are extremely close to the vehicle.

The range of the sensors may change depending on the shape of the object etc.

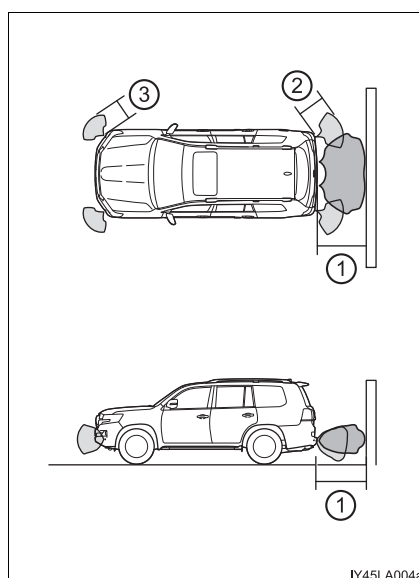

Setting up intuitive parking assist

You can change the buzzer sounds volume and the screen operating conditions.

- 1 Press the "SETUP" button on the multimedia system or navigation system.
- 2 Select "Vehicle" on the "Setup" screen and select "TOYOTA Park Assist Settings".
- 3 Select the desired item.
 - 1 The buzzer sounds volume can be adjusted.

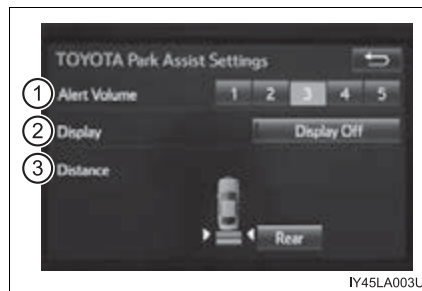

- 2 On or off can be selected for intuitive parking assist display.
- 3 Front or rear center sensors display and tone indication can be set.

■ The intuitive parking assist can be operated when

- Front corner sensors:
 - The engine switch is in IGNITION ON mode.
 - The shift lever is in a position other than P.
 - The vehicle speed is less than approximately 6 mph (10 km/h).
- Rear corner and rear center sensors:
 - The engine switch is in IGNITION ON mode.
 - The shift lever is in R.

■ Intuitive parking assist display

When an obstacle is detected while the rear view monitor system, Multi-terrain Monitor is in use, the warning indicator will appear in the upper corner of the screen even if the display setting has been set to off.

■ Sensor detection information

- The sensor's detection areas are limited to the areas around the vehicle's bumper.
- Certain vehicle conditions and the surrounding environment may affect the ability of a sensor to correctly detect an obstacle. Particular instances where this may occur are listed below.
 - There is dirt, snow or ice on the sensor. (Wiping the sensors will resolve this problem.)
 - The sensor is frozen. (Thawing the area will resolve this problem.)
In especially cold weather, if a sensor is frozen the screen may show an abnormal display, or obstacles may not be detected.
 - The sensor is covered in any way.
 - The vehicle is leaning considerably to one side.
 - On an extremely bumpy road, on an incline, on gravel, or on grass.
 - The vicinity of the vehicle is noisy due to vehicle horns, motorcycle engines, air brakes of large vehicles, or other loud noises producing ultrasonic waves.
 - There is another vehicle equipped with parking assist sensors in the vicinity.
 - The sensor is coated with a sheet of spray or heavy rain.
 - The vehicle is equipped with a fender pole or wireless antenna.
 - The bumper or sensor receives a strong impact.
 - The vehicle is approaching a tall or curved curb.
 - In harsh sunlight or intense cold weather.
 - The area directly under the bumpers is not detected.
 - If obstacles draw too close to the sensor.
 - A non-genuine Toyota suspension (lowered suspension etc.) is installed.
 - People may not be detected if they are wearing certain types of clothing.

In addition to the examples above, there are instances in which, because of their shape, signs and other objects may be judged by a sensor to be closer than they are.

- The shape of the obstacle may prevent a sensor from detecting it. Pay particular attention to the following obstacles:
 - Wires, fences, ropes, etc.
 - Cotton, snow and other materials that absorb sound waves
 - Sharply-angled objects
 - Low obstacles
 - Tall obstacles with upper sections projecting outwards in the direction of your vehicle
- The following situations may occur during use.
 - Depending on the shape of the obstacle and other factors, the detection distance may shorten, or detection may be impossible.
 - Obstacles may not be detected if they are too close to the sensor.
 - There will be a short delay between obstacle detection and display. Even at slow speeds, there is a possibility that the obstacle will come within the sensor's detection areas before the display is shown and the buzzer sounds.
 - Thin posts or objects lower than the sensor may not be detected when approached, even if they have been detected once.
 - It might be difficult to hear beeps due to the volume of audio system or air flow noise of the air conditioning system.

■ **If “Clean Parking Assist Sensor” is displayed on the multi-information display**

A sensor may be dirty or covered with snow or ice. In such cases, if it is removed from the sensor, the system should return to normal.

Also, due to the sensor being frozen at low temperatures, a malfunction display may appear or an obstacle may not be detected. If the sensor thaws out, the system should return to normal.

■ **If “Parking Assist Malfunction” is displayed on the multi-information display**

Depending on the malfunction of the sensor, the device may not be working normally. Have the vehicle inspected by your Toyota dealer.

■ **Customization**

Settings (e.g. buzzer sounds volume) can be changed.
(Customizable features: →P. 574)

 **WARNING****■ When using the intuitive parking assist**

Observe the following precautions.

Failing to do so may result in the vehicle being unable to be driven safely and possibly cause an accident.

- Do not use the sensor at speeds in excess of 6 mph (10 km/h).
- The sensors' detection areas and reaction times are limited. When moving forward or reversing, check the areas surrounding the vehicle (especially the sides of the vehicle) for safety, and drive slowly, using the brake to control the vehicle's speed.
- Do not install accessories within the sensors' detection areas.

 **NOTICE****■ When using intuitive parking assist**

In the following situations, the system may not function correctly due to a sensor malfunction etc. Have the vehicle checked by your Toyota dealer.

- A buzzer does not sound when you turn the intuitive parking assist on.
- The intuitive parking assist operation display flashes, and a buzzer sounds when no obstacles are detected.
- If the area around a sensor collides with something, or is subjected to strong impact.
- If the bumper collides with something, except when the buzzer mute switch has been turned on.
- If the display shows continuously without a beep.
- If a display error occurs, first check the sensor.
If the error occurs even if there is no ice, snow or mud on the sensor, it is likely that the sensor is malfunctioning.

■ Notes when washing the vehicle

Do not apply intensive bursts of water or steam to the sensor area.

Doing so may result in the sensor malfunctioning.

Four-wheel drive system

Use the four-wheel drive control switch and center differential lock/unlock switch to select the following transfer and center differential modes.

Four-wheel drive control switch

- ① H4 (high speed position)
Normal driving on all types of roads.
- ② L4 (low speed position)
Driving requiring maximum power and traction such as climbing or descending steep hills, off-road driving, and hard pulling in sand or mud, etc.
The low speed four-wheel drive indicator will come on.

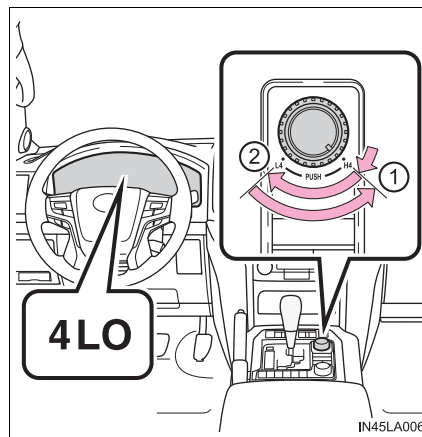

Center differential lock/unlock switch

Lock the center differential when your vehicle's wheels get stuck in a ditch or when driving on a slippery or bumpy surface.

The center differential lock indicator will come on.

Unlock the center differential after the wheels have been freed, or after moving to a flat, non-slippery surface.

To unlock the center differential, push the switch again.

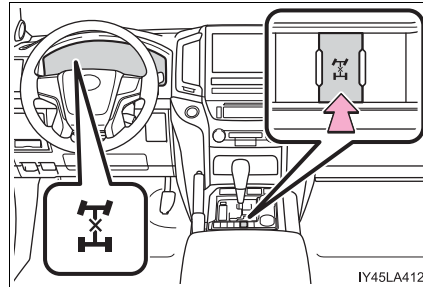

Shifting between H4 and L4

■ Shifting from H4 to L4

- 1 Stop the vehicle completely with brake pedal held down.
- 2 Shift the shift lever to N.
- 3 Push and turn the four-wheel drive control switch fully clockwise.
Maintain this condition until the low speed four-wheel drive indicator turns on.

■ Shifting from L4 to H4

- 1 Stop the vehicle completely with brake pedal held down.
- 2 Shift the shift lever to N.
- 3 Push and shift the four-wheel drive control switch to H4.
Maintain this condition until the low speed four-wheel drive indicator turns off.

■ The four-wheel drive control switch can be operated when

- The engine switch is in IGNITION ON mode.
- The shift lever is in the N position.
- The vehicle is stopped completely.

■ The low speed four-wheel drive indicator light

The indicator light blinks while shifting between H4 and L4.

■ Advice for driving on slippery roads

- If you shift the four-wheel drive control switch to L4 and the shift lever to the 2 range of S while driving in steep off-road areas, the output of the brake can be controlled effectively by the Active TRAC, which assists the driver to control the driving power of 4 wheels.
- Use the 1 range of S of the shift lever for maximum power and traction when your wheels get stuck or when driving down a steep incline.

■ The center differential lock indicator light

The indicator light blinks while locking/unlocking the center differential.

■ The center differential lock/unlock switch can be operated when

- The engine switch is in IGNITION ON mode.
- The vehicle speed is less than 62 mph (100 km/h).

■ Locking/unlocking the center differential

- When the four-wheel drive control switch is in L4 with the center differential locked, VSC is automatically turned off. (The center differential lock and VSC OFF indicator lights come on.)
- If the operation is not completed, the center differential lock indicator blinks. If the indicator light does not turn off when unlocking the center differential, drive straight ahead while accelerating or decelerating, or drive in reverse.
- If the center differential lock/unlock is not completed within 5 seconds while the cruise control system is on, cancel the cruise control system.

■ If the low speed four-wheel drive indicator light or the center differential lock indicator light blinks

- If the low speed four-wheel drive indicator light continues to blink when using the four-wheel drive control switch, stop the vehicle completely, move the shift lever to N and operate the switch again.
- If the shift lever is moved before the low speed four-wheel drive indicator turns on/off, the transfer mode may not be shifted completely. The transfer mode disengages both the front and rear driveshafts from the powertrain and allows the vehicle to move regardless of the shift position. (At this time, the indicator blinks and the buzzer sounds.)

Therefore, the vehicle is free to roll even if the automatic transmission is in P. You or someone else could be seriously injured. You must complete the shifting of the transfer mode.

To complete the shifting, stop the vehicle completely, return the shift lever to N, and confirm that the shift was completed (the indicator turns on/off).

- If the engine coolant temperature is too low, the four-wheel drive control system may not be able to shift. When the engine is warmer press the switch again.

If the low speed four-wheel drive indicator light or the center differential lock indicator light continues to blink even after attempting the above, there may be a malfunction in the engine, the brake system or the four-wheel drive system. In this case, you may not be able to shift between H4 and L4, and the center differential lock may not be operable. Have the vehicle inspected by your Toyota dealer immediately.

 **WARNING**

■ **While driving**

Never move the four-wheel drive control switch if the wheels have lost traction. Doing so may cause an accident resulting in death or serious injury.

■ **When the vehicle is parked**

If the shift lever is moved before the low speed four-wheel drive indicator turns on/off, the transfer mode may not be shifted completely. The transfer mode disengages both the front and rear driveshafts from the powertrain and allows the vehicle to move regardless of the shift position. (At this time, the indicator blinks and the buzzer sounds.)

Therefore, the vehicle is free to roll even if the automatic transmission is in P. You or someone else could be seriously injured. You must complete the shifting of the transfer mode.

 **NOTICE**

■ **To prevent damage to the center differential**

- For normal driving on dry and hard surface roads, unlock the center differential.
- Unlock the center differential after the wheels are out of the ditch or off the slippery or bumpy surface.
- Do not push the center differential lock/unlock switch when the vehicle is turning or when its wheels are spinning freely off the ground.

Crawl Control (with Turn Assist function)

Allows travel on extremely rough off-road surfaces at a fixed low speed without pressing the accelerator or brake pedal. Minimizes loss of traction or vehicle slip when driving on slippery road surfaces, helping for stable driving.

Crawl Control switch

- ① ON/OFF switch
- ② Speed selection switch
- ③ Indicators

The Crawl Control indicator and Multi-terrain Select indicator are lit and the slip indicator flashes when operating.

- ④ Multi-information display
- The operating status and speed select status of the Crawl Control are shown on the multi-information display.

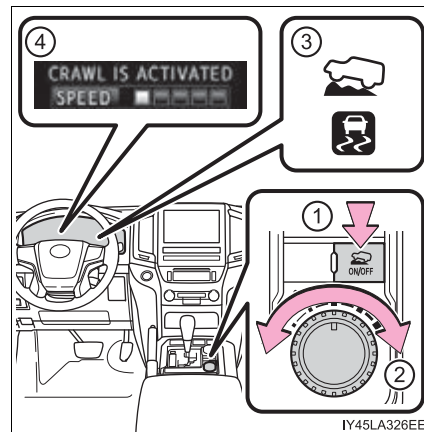

Speed modes

The following table shows some typical terrains and the recommended speed modes.

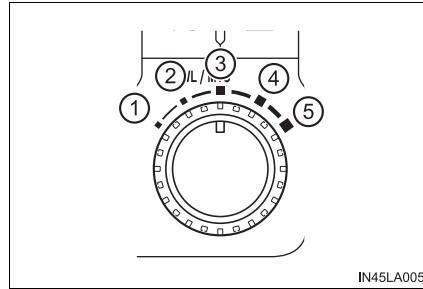

Mode		Road condition
①	Lo	Rock, mogul (downhill) and gravel (downhill)
②	Lo-Med	Mogul (uphill)
③	Med	
④	Med-Hi	Snow, mud, gravel (uphill), sand, dirt, mogul (uphill) and grass
⑤	Hi	

Turn Assist function

This function assists cornering performance in accordance with steering operation when driving through a tight corner. It maintains vehicle speed while driving and reduces the number of turns needed to navigate a corner that requires turning the wheel in the opposite direction.

Press the Turn Assist switch while Crawl Control is operating.

- Turn Assist indicator will come on.
- To turn the system off, press the switch again.

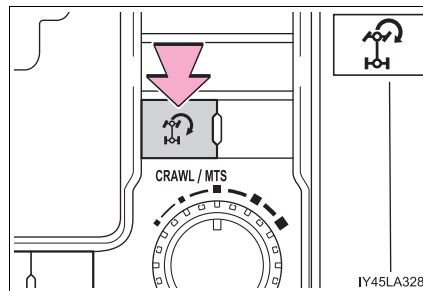

4
Driving

When the system is turned off

▶ Crawl Control

Press the ON/OFF switch while Crawl Control is operating. If the switch is turned off, the slip indicator and the Turn Assist indicator will go off (if the Turn Assist function is in use), the Crawl Control indicator will flash until the system has turned off completely, and a message stating that Crawl Control has been turned off will be displayed on the multi-information display for several seconds.

When turning off Crawl Control while driving, stop the vehicle before the Crawl Control indicator turns off, or drive extremely carefully.

▶ Turn Assist function

Press the Turn Assist switch while the Turn Assist function is operating. When the switch is pressed, the Turn Assist indicator will go off, and a message stating that the Turn Assist function has been turned off will be displayed on the multi-information display for several seconds.

■ The Crawl Control and Turn Assist function can be operated when

▶ Crawl Control

- The engine is running.
- The shift lever is in any gear other than P or N.
- The four-wheel drive control switch is in L4.
- The driver's door is closed.

▶ Turn Assist function

- Crawl Control is operating.
- The center differential is not locked.
- The accelerator and brake are not being operated.
- The shift lever is in any gear other than P, R or N.
- The steering wheel is turned very far.

■ Automatic system cancelation

▶ Crawl Control

In the following situations, the buzzer will sound intermittently and Crawl Control will be canceled automatically. In this event, the Crawl Control indicator will flash and then go off, the Turn Assist indicator will go off (if the Turn Assist function is in use), and a message stating that Crawl Control has been turned off will be displayed on the multi-information display for several seconds.

- When the shift lever is moved to P or N.
- When the four-wheel drive control switch is in H4.
- When the driver's door is opened.

▶ Turn Assist function

When the center differential is locked, the buzzer will sound intermittently and the Turn Assist function will be canceled automatically. In this event, the Turn Assist indicator will go off, and a message stating that the Turn Assist function has been turned off will be displayed on the multi-information display for several seconds.

■ Function limitations

▶ Crawl Control

- In the following situations, brake control can be used to drive downhill at a constant speed. However, engine control is not available when driving uphill at a constant speed.
 - When switched to second start mode.
- In the following situation, engine control and brake control will stop temporarily. In this event, the Crawl Control indicator will flash.
 - When the vehicle speed exceeds approximately 15 mph (25 km/h).

▶ Turn Assist function

In the following situations, the Turn Assist function will stop temporarily. In this event, the Turn Assist indicator will flash.

- When the vehicle speed exceeds approximately 6 mph (10km/h).
- When the shift lever is moved to R.

■ When the Crawl Control system is operated continuously

- If Crawl Control is used continuously for a long time, the buzzer will sound, a malfunction notification will be displayed on the multi-information display, the Crawl Control indicator will go off, and Crawl Control will be temporarily inoperable as a result of the brake system overheating. In this event, stop the vehicle immediately in a safe place, and allow the brake system to cool down sufficiently until the TRAC OFF indicator goes off. (In the meantime, normal driving is possible.)
- If Crawl Control is used continuously for a long time, the buzzer will sound, the system will be temporarily canceled, and a malfunction notification will be displayed on the multi-information display as a result of the automatic transmission system overheating. Stop the vehicle in a safe place until the display goes off.

■ **When depressing the accelerator pedal while the Crawl Control is operating**

Multi-terrain Select operates in AUTO mode. (→P. 290)

■ **Sounds and vibrations caused by the Crawl Control system**

- A sound may be heard from the engine compartment when the engine is started or just after the vehicle begins to move. This sound does not indicate that a malfunction has occurred in Crawl Control system.
- Either of the following conditions may occur when the Crawl Control system is operating. None of these are indicators that a malfunction has occurred.
 - Vibrations may be felt through the vehicle body and steering.
 - A motor sound may be heard after the vehicle comes to a stop.

■ **When there is a malfunction in the system**

Warning lights and/or warning messages will turn on. (→P. 510, 519)

 WARNING
<p>■ When using Crawl Control Do not rely solely on the Crawl Control. This function does not extend the vehicle's performance limitations. Always thoroughly check the road conditions, and drive safely.</p> <p>■ These conditions may cause the system not to operate properly When driving on the following surfaces, the system may not be able to maintain a fixed low speed, which may result in an accident:</p> <ul style="list-style-type: none"> ● Extremely steep inclines. ● Extremely uneven surfaces. ● Snow-covered roads, or other slippery surfaces.

 NOTICE
<p>■ When using Turn Assist function The Turn Assist function is a function to assist turning performance when driving off road. The function may be less effective on paved road surfaces.</p>

Multi-terrain Select

Multi-terrain Select is a system that helps drivability in off-road situations.

- ▶ When the Crawl Control is turned off

Select a mode that most closely matches the type of terrain on which you are driving from among 5 modes.

Brake control can be optimized in accordance with the selected mode.

- ▶ When the Crawl Control is turned on

A mode which matches the road conditions is automatically selected by depressing the accelerator pedal (AUTO mode).

Multi-terrain Select switch/indicators

- ① Multi-terrain Select mode select switch
- ② Multi-information display
Displays status information including operating status and road type selection.
- ③ Multi-terrain Select indicator

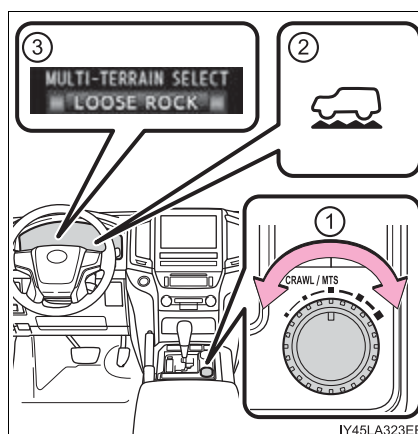

Selectable modes

When the Crawl Control is turned off, a mode which matches the road conditions can be selected from among the following 5 modes.

- ① MUD & SAND
- ② LOOSE ROCK
- ③ MOGUL
- ④ ROCK & DIRT
- ⑤ ROCK

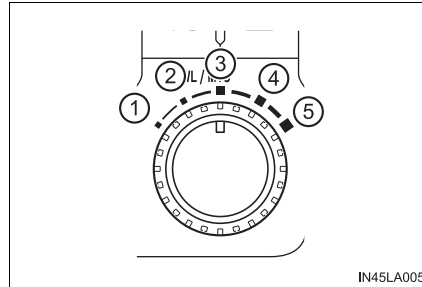

Mode		Road Conditions
①	MUD & SAND	Suitable for muddy roads, sandy roads, snow-covered roads, dirt trails and other slippery or dirty conditions
②	LOOSE ROCK	Suitable for slippery conditions consisting of mixtures of earth and loose rock
③	MOGUL	Suitable for a wide range of off-road conditions, particularly very bumpy conditions
④	ROCK & DIRT	Suitable for very bumpy road conditions, such as mogul or rocky roads.
⑤	ROCK	Suitable for rocky terrain

When the Crawl Control is turned on, the most suitable mode is automatically selected according to the Crawl Control mode selected.

Multi-terrain Select control starting conditions

When all of the following conditions are satisfied, the Multi-terrain Select indicator will come on, the mode select screen will be displayed on the multi-information display, and Multi-terrain Select control will begin.

- The four-wheel drive control switch is in “L4”.
- Both Active TRAC and VSC are not off.

Switching modes

Operate the Multi-terrain Select mode select switch during Multi-terrain Select control to select a mode.

Once the mode is confirmed, the mode name will be displayed and the control will switch.

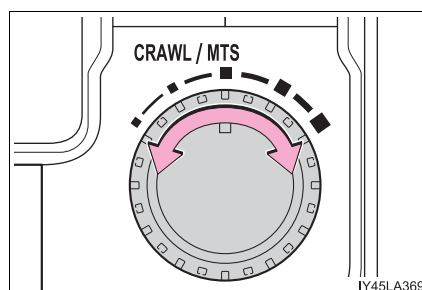

■ Automatic system cancelation

In the following situations, the Multi-terrain Select indicator will go off, and Multi-terrain Select will be canceled automatically

- When the four-wheel drive control switch is in H4.
- When Active TRAC and VSC are off.

■ When it is difficult to generate traction

MUD & SAND mode provides the largest amount of tire slippage, followed by LOOSE ROCK, MOGUL, ROCK & DIRT and ROCK mode.

Drivability can be improved by selecting a mode which provides a smaller amount of tire slippage than the current mode when the amount of tire slippage is large, or conversely selecting a mode which provides a larger amount of tire slippage than the current mode when the amount of tire slippage is small.

■ When the vehicle is stuck

Switching the transfer and differential

For the operation of the following functions, refer to the following pages.

- Four-wheel drive system (→P. 280)
- Center differential lock (→P. 281)

■ When the brake system operates continuously

The brake system may overheat. In this case, a buzzer will sound, the TRAC OFF indicator will flash, and Multi-terrain Select will be temporarily inoperable. In this event, stop the vehicle immediately in a safe place, and allow the brake system to cool down sufficiently. (There is no problem with continuing normal driving.)

After a short time, the TRAC OFF indicator will go off, and you will be able to use Multi-terrain Select.

■ When there is a malfunction in the system

The slip indicator light will come on. Have the vehicle inspected by your Toyota dealer immediately.

 **WARNING****■ When using the Multi-terrain Select**

Observe the following precautions to avoid an accident that could result in death or serious injuries:

- There is a chance that the selected mode may not be the most appropriate in terms of road conditions such as pitch, slipperiness, undulation, etc. (→P. 290)
- Multi-terrain Select is not intended to expand the limits of the vehicle. Check the road conditions thoroughly beforehand, and drive safely and carefully.

 **NOTICE****■ Precaution for use**

The Multi-terrain Select is intended for use during off-road driving. Do not use the system at any other time.

Multi-terrain Monitor

The Multi-terrain Monitor helps the driver to check the vehicle surroundings. It assists in determining the conditions around the driver in a variety of situations, such as when judging conditions during off-road driving or checking for obstacles when parking.

WARNING

■ When using the Multi-terrain Monitor system

Observe the following precautions to avoid an accident that could result in death or serious injuries.

- Never rely solely on the Multi-terrain Monitor. As with unequipped vehicles, drive carefully while directly confirming the safety of your surroundings and the area to the rear of the vehicle. Take particular care to avoid parked cars and other obstacles.
- Due to the characteristics of the camera lens, the actual position and distance of people and other obstacles will differ from those shown on the Multi-terrain Monitor screen. Directly confirm the safety of your surroundings before driving.
- Do not drive while only looking at the screen. When driving, make sure to directly confirm the safety of your surroundings, such as by visually checking the area and using the vehicle's mirrors.
- In low temperatures, the screen may darken or the images may become faint.
Images of moving objects in particular may distort or disappear from the screen. Therefore, make sure to drive carefully while directly visually confirming the safety of your surroundings.

Multi-terrain Monitor screens

The following screens can be selected according to driving conditions.

- Screens that can be selected vary depending on conditions such as shift position and vehicle speed. (→P. 299)
- Depending on the displayed screen, the display can be switched from normal to wide view display.

■ **Screens when the four-wheel drive control switch is in L4**

- When checking the area to the front and sides of the vehicle

▶ Front view & dual side view

▶ Front view & dual side view (front magnified)

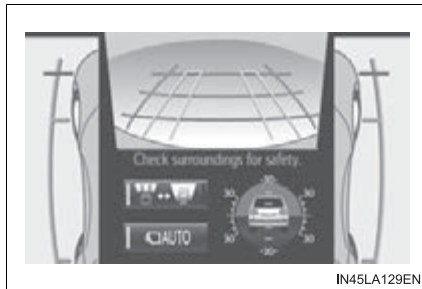

→P. 302



→P. 302

- When checking the condition of the road surface under the vehicle

▶ Under vehicle terrain view & dual side view

▶ Under vehicle terrain view & dual side view (front magnified)

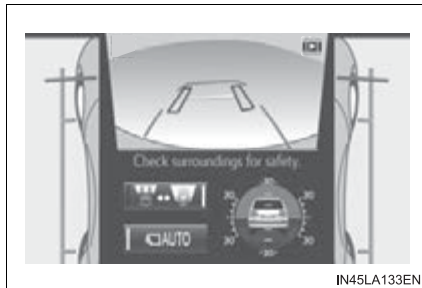

→P. 306

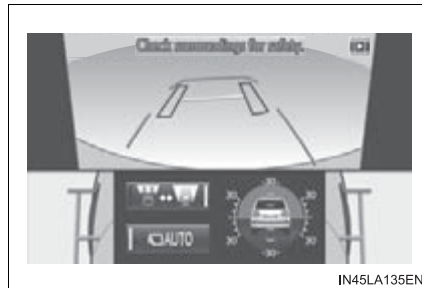

→P. 306

● When checking the area to the rear of the vehicle

▶ Rear view & dual side view

▶ Wide rear view

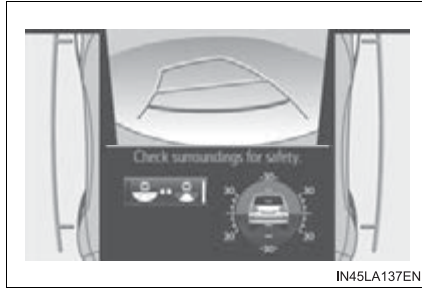

→P. 308

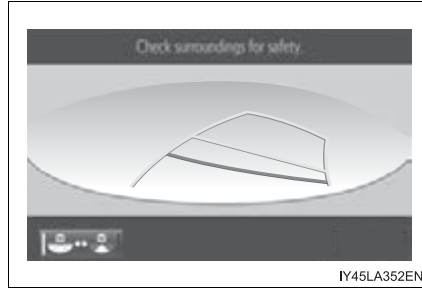

→P. 308

■ Screens when the four-wheel drive control switch is in H4

● When checking the area to the front of the vehicle (panoramic view & wide front view)

→P. 310

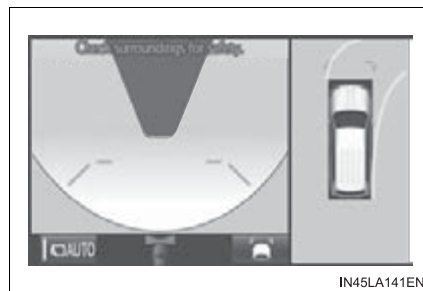

● When checking the area to the sides of the vehicle (dual side view)

→P. 312

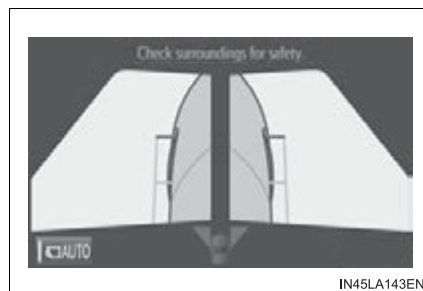

● When checking the area to the rear of the vehicle

▶ Panoramic view & rear view

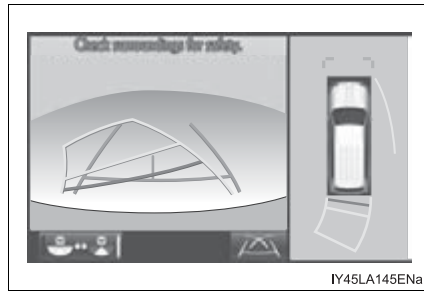

→P. 315

▶ Wide rear view

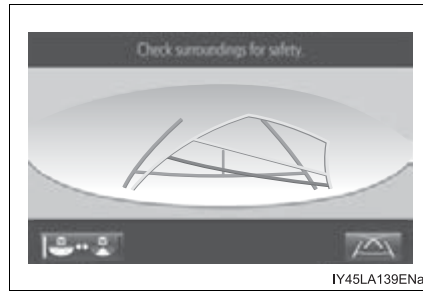

→P. 315

● When checking the area to the sides, front and rear of the vehicle (with outside rear view mirrors retracted)

▶ Side view & wide front view

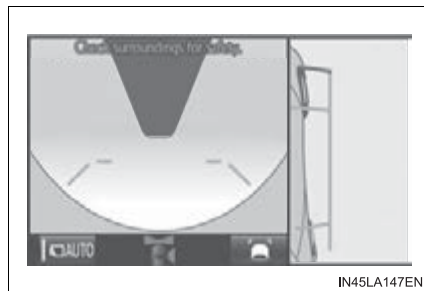

→P. 321

▶ Side view & rear view

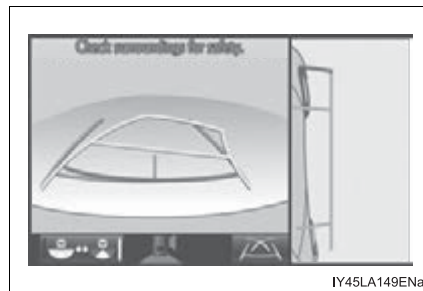

→P. 321

▶ Dual side view

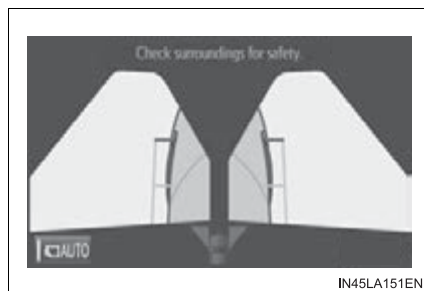

→P. 321

Using the Multi-terrain Monitor screen

■ Displaying the Multi-terrain Monitor screen

The Multi-terrain Monitor screen will be displayed when the VIEW switch is pressed while the engine switch is in IGNITION ON mode.

When the vehicle speed exceeds a certain value, the display returns to the navigation or information display screen.

The amount of time that the Multi-terrain Monitor is displayed differs depending on conditions such as the vehicle speed. (→P. 302)

- ① VIEW switch
- ② Display

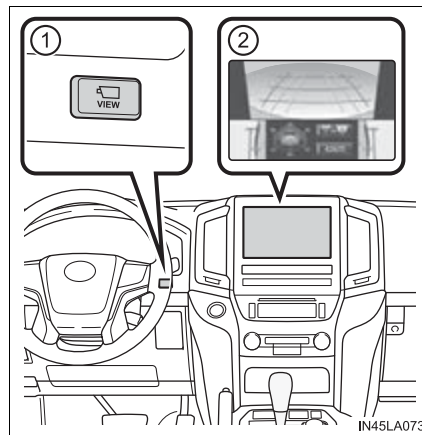

■ **Switch operations**

On some screens, the display mode or display settings can be changed using the switches.

● **Automatic display mode switch**

When automatic display mode is turned on, the Multi-terrain Monitor screen is displayed in the following conditions, even if the VIEW switch has not been operated.

- The shift lever is shifted to D or N
- While driving, the vehicle speed drops to approximately 10 km/h (6 mph) or less (except when the shift lever is in R)

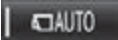
The automatic display mode switches between on and off each time  is selected.

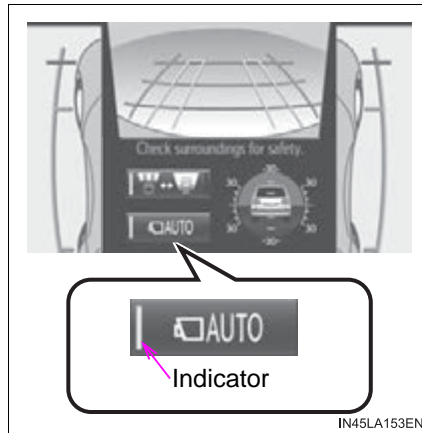

When automatic display mode is on, an indicator illuminates on the icon.

Even when automatic display mode is on, the display can still be switched by pressing the VIEW switch.



● **Display selection switches**







The following switches can be pressed or selected to switch the Multi-terrain Monitor display screen and to switch from normal to wide view display.

Switch		Switch Function
VIEW switch		Changing a display (→P. 299)
Angle mode selection switch		Switches between the wide rear view and wide view display (→P. 308, 315)
Under vehicle terrain view selection switch		Switches between the front view and under vehicle terrain view (→P. 302, 306)

Changing the Multi-terrain Monitor screen

The screen display can be switched by operating the switches as follows while the Multi-terrain Monitor screen is displayed. (Screens that can be displayed will vary depending on the positions of the shift lever and four-wheel drive control switch)

■ Screens when the four-wheel drive control switch is in L4

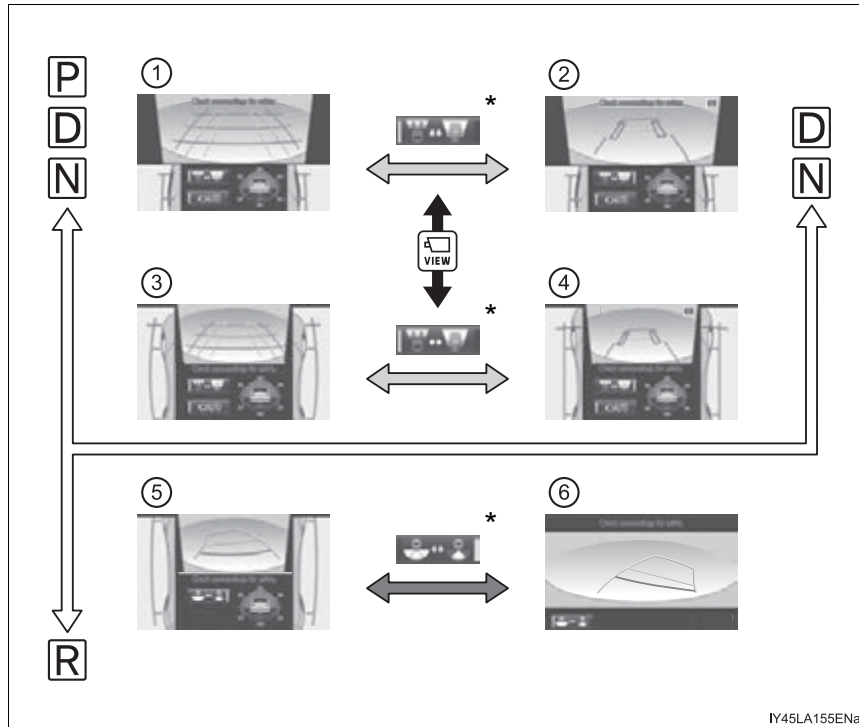

-  : Press 
-  : Select 
-  : Select 
-  : Operate the shift lever



- ① Front view & dual side view (front magnified): →P. 302
- ② Under vehicle terrain view & dual side view (front magnified): →P. 306
- ③ Front view & dual side view: →P. 302
- ④ Under vehicle terrain view & dual side view: →P. 306
- ⑤ Rear view & dual side view: →P. 308
- ⑥ Wide rear view: →P. 308

*: The screen display can be switched by touching the image from the camera on the screen.

■ Screens when the four-wheel drive control switch is in H4

- ➡ : Press 
- ➡ : Select 
- ➡ : Operate the shift lever

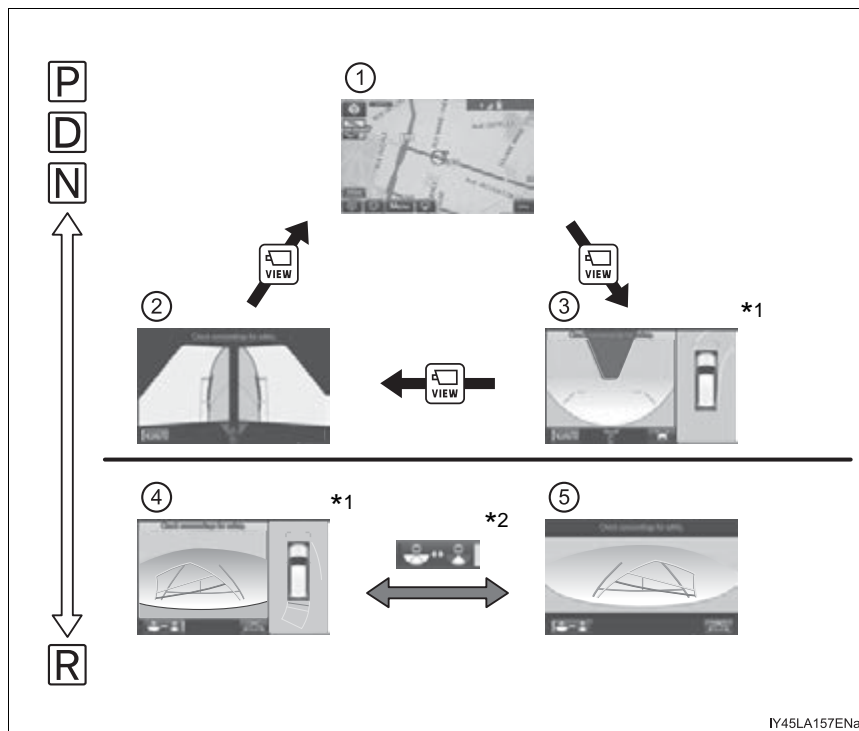

- ① Navigation screen, information settings screen, etc.
- ② Dual side view: →P. 312
- ③ Panoramic view & wide front view: →P. 310
- ④ Panoramic view & rear view: →P. 315
- ⑤ Wide rear view: →P. 315

*1: The displayed screen differs when the outside rear view mirrors are retracted.

*2: The screen display can be switched by touching the image from the camera on the screen.

■ **Multi-terrain Monitor screen display**

The amount of time that the Multi-terrain Monitor screen is displayed changes as follows according to the vehicle speed at the time the VIEW switch was pressed.

The Multi-terrain Monitor screen is displayed if the vehicle speed is approximately 7 mph (12 km/h) or less when the VIEW switch is pressed.

If the vehicle speed exceeds approximately 7 mph (12 km/h), the Multi-terrain Monitor display is canceled.

Screen display and functions

The various screens of the Multi-terrain Monitor display information to support several different driving situations, such as when checking for obstacles when moving forward or in reverse, or when judging road surface conditions during off-road driving.

■ **Front view & dual side view**

Front view & dual side view can be used to check the area around the front of the vehicle.

- In addition to an image of the front of the vehicle, guide lines are displayed in a composite view to provide reference for when deciding a direction to move forward in.
- If the VIEW switch is pressed while the screen is displayed, the screen switches from normal to magnified display. (Pressing the switch again returns the screen to the normal display)
- If the steering wheel is turned 270° or more, guide lines and other features to support turning are automatically displayed.

● Screen description

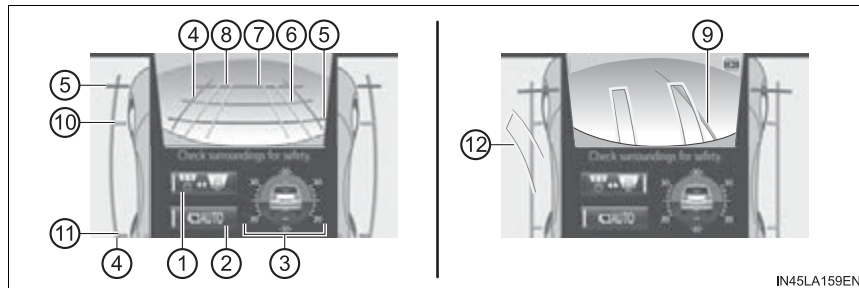

- ① Under vehicle terrain view selection switch
Switches between front view and under vehicle terrain view display each time the switch is selected.
- ② Automatic display mode selection switch
→P. 298
- ③ Tilt meter/slip display
Displays the vehicle's estimated degree of incline or indicates a tire slippage. (→P. 304)
- ④ Vehicle width lines (blue)
Indicate the width of the vehicle including the outside rear view mirror.
- ⑤ 1.5 ft. (0.5 m) distance guide line (red)
- ⑥ 3 ft. (1 m) distance guide line (blue)
- ⑦ 6 ft. (2 m) distance guide line (blue)
Items ⑤ to ⑦ indicate the estimated distance from the front end of the vehicle.
- ⑧ Front tire course line (yellow)
Indicates the estimated course of the front tires according to steering wheel position.
- ⑨ Forward movement guide line (blue)
Indicates the estimated tire course of the tightest possible turn.
- ⑩ Front tire contact line (blue)
- ⑪ Rear tire contact line (blue)
Items ⑩ and ⑪ indicate estimated tire positions on the image.
- ⑫ Rear tire course line (yellow)
Indicates the estimated course of the rear tires.

● Front view rotating display function

This function operates when the four-wheel drive control switch is in L4.

The front view image is automatically adjusted to be parallel and assist the driver to check road surface conditions regardless of the vehicle inclination.

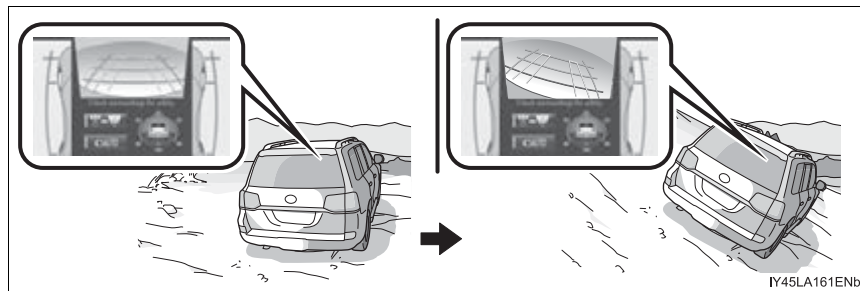

● Tilt meter

Tilt meter displays the vehicle inclination to the front, rear, left and right within a range of 0° to approximately 30°.

- ① Degree markers of incline to the front and rear

Indicates the vehicle inclination in degrees in the front and rear directions.

- ② Degree markers of incline to the left and right

Indicates the vehicle inclination in degrees in the left and right directions.

- ③ Pointer

Indicates the degree of the vehicle inclination in comparison to a parallel line.

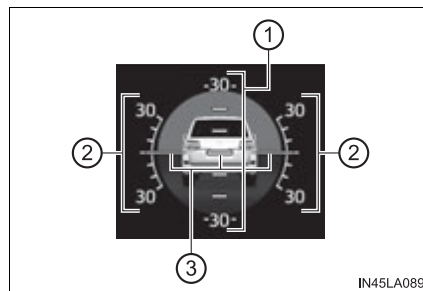

● Slip display

When tire slippage is detected, the tilt meter display area is automatically switched to the slip display.

① Tire display

Indicates the position of freely spinning tires in yellow if the tire spins. (During Crawl Control is operating, all of the tires are indicated in yellow.)

② Pop-up display of the intuitive parking assist

Displayed if an obstacle is detected while the intuitive parking assist is turned on.

③ Pop-up display of the RCTA

Displayed if a vehicle approaching from right or left rear of the vehicle is detected while the RCTA is turned on.

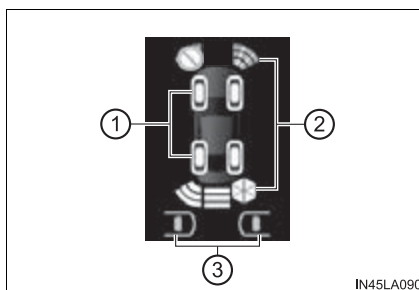

■ Front view & dual side view display

The screen can be displayed when the shift lever is in P, D or N.

■ Front view rotating display function

- The vehicle inclination displayed on the screen may differ from the actual state.
- When the rotated screen is displayed, the corners of the front bumper may not be seen on the screen.

■ Tilt meter display

- The display indicates the incline of the vehicle in degrees shown by the movement of the pointer and the rotation of the vehicle image.
- The color of the degree markers of incline to the front, rear, left and right changes according to the current incline of the vehicle.
- After the engine switch is turned to IGNITION ON mode, the degree of incline is not displayed until such information is determined.
- The degree of incline showed on the tilt meter is only an approximate indication, and may differ from the degree of incline measured using other equipment.

■ Tilt meter/slip display

When the intuitive parking assist or RCTA detects an obstacle or another vehicle, a warning message pops up in the tilt meter/slip display area.

■ **Under vehicle terrain view & dual side view**

Lines indicating current vehicle and tire position are displayed in a composite view on an image taken approximately 10 ft. (3 m) behind the current vehicle position and assists the driver to check conditions underneath the vehicle or determine the position of the front tires.

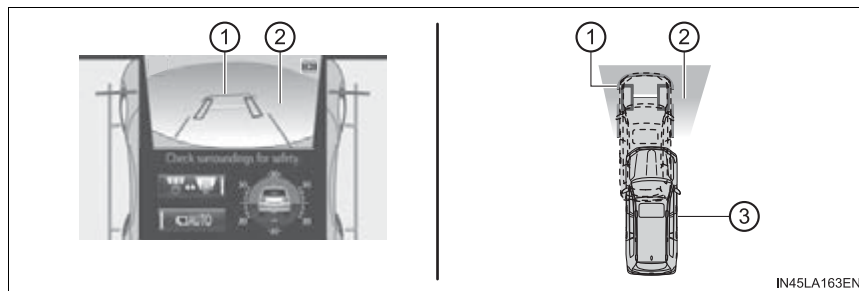

- ① Current vehicle position
- ② Image displayed in the under vehicle terrain view (image taken approximately 10 ft. (3 m) behind the current vehicle position)
- ③ Vehicle position at the time the image was taken (approximately 10 ft. (3 m) behind the current vehicle position)

● **Displaying the under vehicle terrain view**

While the front view is displayed, stop the vehicle completely, and then press .

Pressing  again returns the screen to the front view display.

● **Screen description**

- ① Tire position indicator lines (black)

Indicates the estimated position of the front tires.

- ② Vehicle position indicator lines (blue)

Indicates the estimated position of the vehicle.

- ③ Icon (flashing)

Indicates that the under vehicle terrain view display is of an image taken in the past.

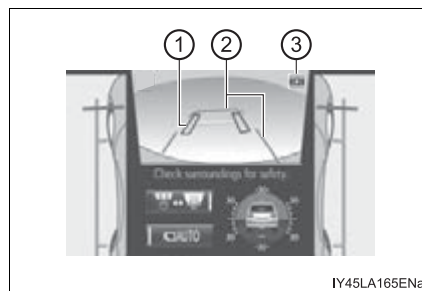

■ Under vehicle terrain view & dual side view

- The screen can be displayed when the shift lever is in D or N.
- While the under vehicle terrain view is displayed, if the vehicle speed reaches or exceeds approximately 5 km/h (3 mph), the screen automatically returns to the front view display.
- In the following situations, the under vehicle terrain view selection switch cannot be operated.
 - The vehicle is not completely stopped
 - After the engine starts, a fixed distance or more has not been driven
 - After the four-wheel drive control switch is shifted to L4, a fixed distance or more has not been driven
- In the following situations, the system may not operate normally, or it may not be possible to switch to the under vehicle terrain view.
 - The road is covered with snow
 - It is nighttime and the road has no illumination
 - Dirt or foreign matter is adhering to the camera lens
 - There is water in front of the vehicle (a river, puddle, sea water, etc.)

⚠ WARNING**■ Guide lines**

The tire position indicator lines and vehicle position indicator lines may differ from actual vehicle positions depending on the number of passengers, cargo weight, road grade, road surface conditions, brightness of the surrounding environment, etc. Always drive the vehicle while confirming the safety of your surroundings.

■ Under vehicle terrain view display

The image displayed is one that was previously taken at a point approximately 10 ft. (3 m) behind the current vehicle position. In cases such as when objects move after the image is taken, the image displayed on the screen may differ from the actual state.

■ **Rear view & dual side view/wide rear view**

Guide lines are displayed in a composite view on an image of the area to the rear of the vehicle to use as a reference when deciding a course of movement and assist the driver to check the safety of the area to the rear of the vehicle or to park the vehicle.

● **Screen description**

The following 2 types of display mode can be selected according to conditions.

- ▶ Rear view & dual side view display
- ▶ Wide rear view display

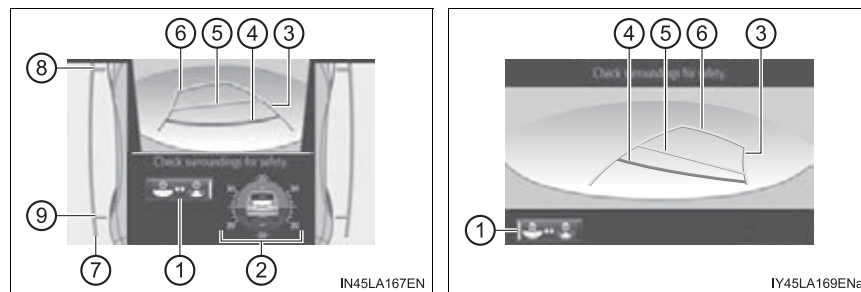

① **Angle selection switch**

Switches between rear view & dual side view display and wide rear view display each time the switch is selected.

② **Tilt meter/slip display**

→P. 304

③ **Projected course lines (yellow)**

Indicate the estimated course of the vehicle according to steering operations.

④ **1.5 ft. (0.5 m) distance guide line (red)**

⑤ **3 ft. (1 m) distance guide line (yellow)**

⑥ **8 ft. (2.5 m) distance guide line (yellow)**

④, ⑤ and ⑥ indicate the estimated distance from the rear end of the vehicle.

⑦ Vehicle width extension guide line (blue)

Indicates the estimated vehicle width including the outside rear view mirrors.

⑧ Front tire contact line (blue)

⑨ Rear tire contact line (blue)

Items ⑧ and ⑨ indicate estimated tire positions on the image.

■ Rear view & dual side view/wide rear view

The screen can be displayed when the shift lever is in R.

■ Guide lines

If the back door is not closed, guide lines will not be displayed. If the guide lines do not display even when the back door is closed, have the vehicle inspected at your Toyota dealer.

■ Intuitive parking assist pop-up display

→P. 272

 **WARNING**
■ Guide lines

The tire position indicator lines and vehicle position indicator lines may differ from actual vehicle positions depending on the number of passengers, cargo weight, road grade, road surface conditions, brightness of the surrounding environment, etc. Always drive the vehicle while confirming the safety of your surroundings.

■ **Panoramic view & wide front view**

The image looking down at the vehicle from above and the image from the front camera are displayed simultaneously and assist the driver to check conditions in front, and to the right and left, of the vehicle at intersections or T-junctions with poor visibility.

● **Screen description**

The following 2 types of display mode can be selected according to conditions.

- ▶ Distance guide line display mode
- ▶ Projected course line display mode

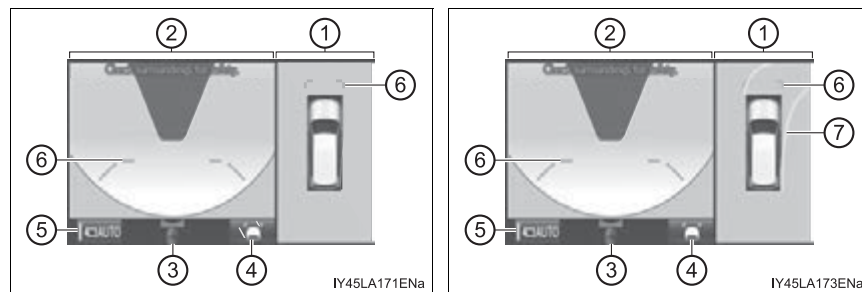



- ① **Panoramic view**
Displays an image looking down at the vehicle from above.
- ② **Wide front view**
Displays an image of the area to the front of the vehicle.
- ③ **Display area**
- ④ **Guide line display selection switch**
→P. 311
- ⑤ **Automatic display mode selection switch**
→P. 298
- ⑥ **Front distance guide line (blue)**
Indicates a distance approximately 3 ft. (1 m) from the front end of the vehicle.
- ⑦ **Forward projected course lines**
Automatically displayed when the steering wheel is turned 90° or more from the center position.
Indicates the estimated course of the vehicle according to steering wheel operations.

- Switching to automatic display mode

→P. 298

- Switching guide line display modes

The mode switches and the switch display changes each time the guide line display selection switch is selected.

Selected mode	Distance guide line display mode	Projected course line display mode
Switch display		

- Panoramic view & wide front view

The screen can be displayed when the shift lever is in P, D or N.

- Intuitive parking assist pop-up display

→P. 272

<p> WARNING</p>
<p>■ Guide lines</p> <p>The tire position indicator lines and vehicle position indicator lines may differ from actual vehicle positions depending on the number of passengers, cargo weight, road grade, road surface conditions, brightness of the surrounding environment, etc. Always drive the vehicle while confirming the safety of your surroundings.</p>

■ Dual side view

The image from the both side cameras is displayed and assists the driver to check conditions on the sides of the vehicle or to confirm the safety of narrow roads.

● Screen description

- ① Side view (left front side)
- ② Side view (right front side)
- ③ Display area
- ④ Vehicle width lines (blue)

Indicate the estimated vehicle width including the outside rear view mirrors.

- ⑤ Front distance guide line (red)

Indicates a distance approximately 1.6 ft. (0.5 m) from the front end of the vehicle.

- ⑥ Front tire contact line (blue)

Indicates the estimated front tire position on the image.

- ⑦ Automatic display mode selection switch

→P. 298

- ⑧ Intuitive parking assist

When the intuitive parking assist is on, an icon will pop up when an obstacle is detected. (Refer to P. 272 for information about the intuitive parking assist.)

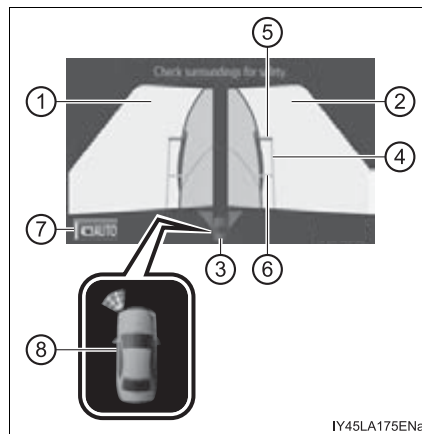

● Using the vehicle width lines

The relative distance of obstacles from the vehicle width lines can be confirmed.

Example 1: When there is an obstacle in front of the vehicle
Operate the steering wheel so that the vehicle width line and the obstacle do not overlap.



Example 2: When parking on the shoulder
Approach the shoulder, but do not allow the vehicle width line to overlap the curb or other obstacles.
After confirming the distance to the shoulder of the road, maneuvering the vehicle so that the vehicle width line and the curb or other obstacle are parallel allows the vehicle to be parked evenly.



■ **Dual side view**

- The screen can be displayed when the shift lever is in P, D or N.
- When the outside rear view mirrors are retracted, the displayed area changes (the area on the screen that is not masked in black). (→P. 321)

■ **Intuitive parking assist pop-up display**

→P. 272

 **WARNING**

■ **Guide lines**

The tire position indicator lines and vehicle position indicator lines may differ from actual vehicle positions depending on the number of passengers, cargo weight, road grade, road surface conditions, brightness of the surrounding environment, etc. Always drive the vehicle while confirming the safety of your surroundings.

■ **Panoramic view & rear view/wide rear view**

- Panoramic view & rear view:

The image looking down at the vehicle from above and the image from the rear camera are displayed simultaneously and assist the driver to check the safety of the area when parking.

- Wide rear view:

The image from the rear camera is displayed in a range of approximately 180° and assists the driver to check the safety of the area when backing up.

● **Screen description**

▶ Panoramic view & rear view

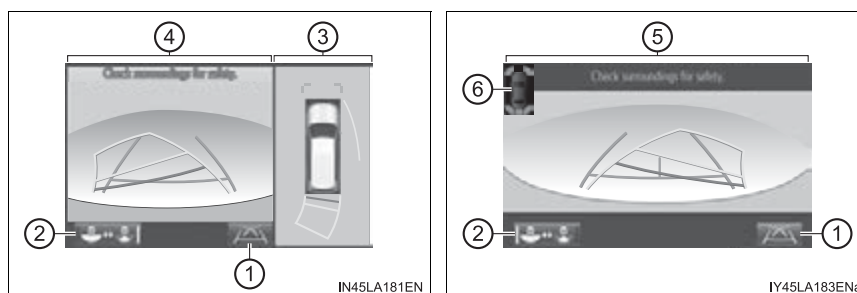

▶ Wide rear view



- ① Guide line selection switch
→P. 311
- ② Angle mode selection switch
Switches between the panoramic view & rear view and wide rear view display each time the switch is selected.
- ③ Panoramic view & rear view
- ④ Rear view
Switches the screen to wide rear view display when you touch the display.
- ⑤ Wide rear view
Switches the screen to the panoramic & rear view display when you touch the display.
- ⑥ Intuitive parking assist
When the intuitive parking assist is turned on, an icon will pop up when an obstacle is detected. (Refer to P. 272 for information about the intuitive parking assist.)

● Switching modes

The display mode switches and the icon display changes each time the guide line display selection switch is selected.

Selected mode	Projected course line display mode	Parking assist guide line display mode	Distance guide line display mode
Icon display			

- Projected course line display mode:
Projected course lines that change according to steering wheel operations are displayed.
- Parking assist guide line display mode:
Inverted steering wheel operations (parking assist guide line) are displayed. Use this mode if you are used to how the vehicle handles (if you can park without needing the course line display).
- Distance guide line display mode:
Only distance guide lines are displayed. Use this mode when guide lines are not needed.

● Guide lines

The panoramic view & rear view screen is explained here as an example.

- ▶ Projected course line display mode ▶ Parking assist guide line display mode

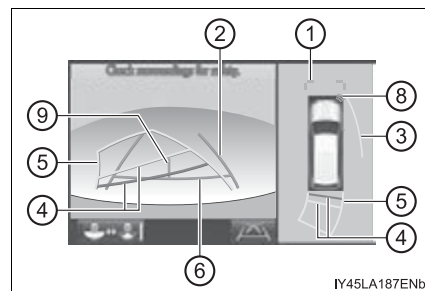
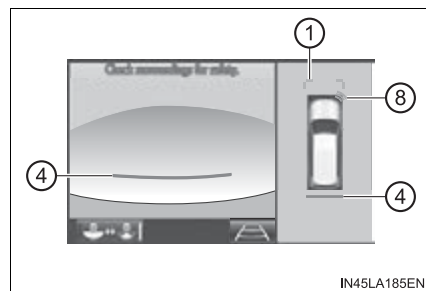

► Distance guide line display mode

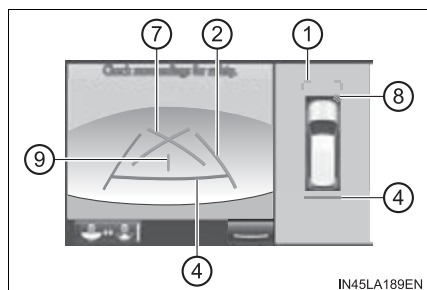

- ① Front distance guide line (blue)

Indicates a distance approximately 3 ft. (1 m) from the front end of the vehicle.
- ② Rear vehicle width extension guide lines

Indicate the estimated course of the vehicle when backing up straight.

 - The displayed width is wider than the actual vehicle width.
 - In projected course line display mode, this item overlaps the projected course lines when going straight.
- ③ Side projected course line (yellow)

Indicates the projected reverse course calculated by the angle of the steering wheel.

The projected reverse course line on the outside of the turn is displayed according to the direction of the steering wheel.
- ④ Rear distance guide line

Indicates the estimated distance from the end of the rear bumper (at the center). (Red line: approximately 1.5 ft. [0.5 m] away. Yellow line: approximately 3 ft. [1 m] away.)

In projected course line display mode, the rear distance guide line changes according to steering wheel operations.
- ⑤ Projected reverse course (yellow)

Changes according to steering wheel operations and indicates the estimated course of the vehicle.
- ⑥ Rear distance guide line (blue)

Indicates a distance approximately 1.5 ft. (0.5 m) from the end of the rear bumper (at the center).
- ⑦ Parking assist guide line (blue)

Indicates the estimated tire course of the tightest possible turn in reverse.

⑧ Intuitive parking assist

When the intuitive parking assist is on, an icon will be displayed when an obstacle is detected. (Refer to P. 272 for information about the intuitive parking assist.)

⑨ Vehicle center line (blue)

Indicates the estimated vehicle center on the ground.

● Parking (using the estimated course line)

When parking in a space which is in the reverse direction to the space described in the procedure below, the steering directions will be reversed.

① Shift the shift lever to the R position.

② Turn the steering wheel so that the estimated course lines are within the parking space, and back up slowly.

① Parking space

② Estimated course lines

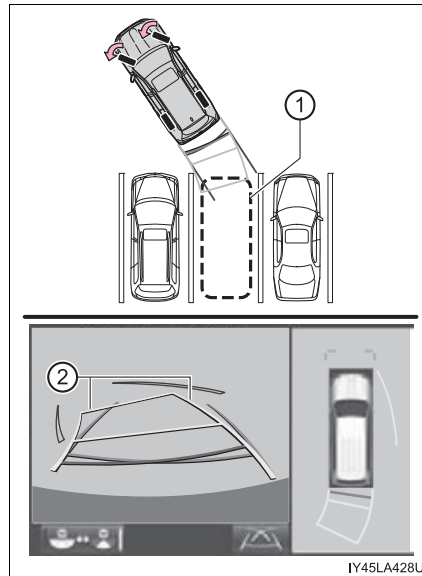

- 3 When the rear position of the vehicle has entered the parking space, turn the steering wheel so that the vehicle width extension guide lines are within the left and right dividing lines of the parking space.

- ③ Vehicle width extension guide line

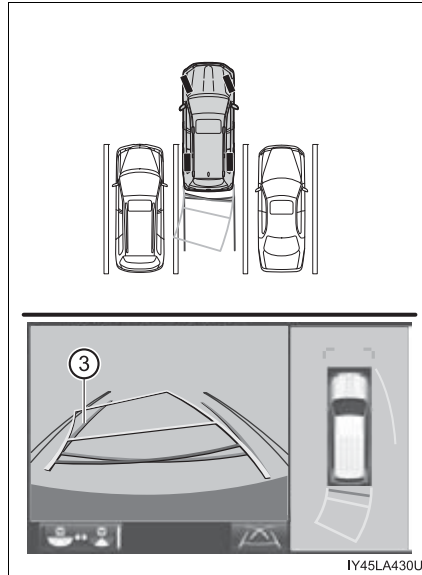

- 4 Once the vehicle width extension guide lines and the parking space lines are parallel, straighten the steering wheel and back up slowly until the vehicle has completely entered the parking space.
- 5 Stop the vehicle in an appropriate place, and finish parking.

● Parking (using the estimated course line)

- 1 Shift the shift lever to the R position.
- 2 Back up until the parking assist guide line meets the edge of the left-hand dividing line of the parking space.

- ① Parking assist guide line
- ② Parking space dividing line

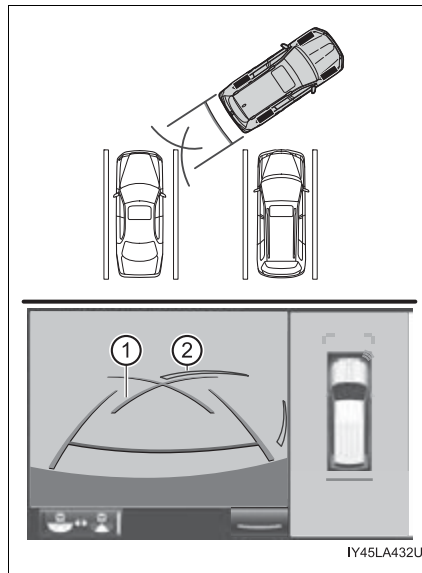

- 3 Turn the steering wheel all the way to the right, and back up slowly.
- 4 Once the vehicle is parallel with the parking space, straighten the steering wheel and back up slowly until the vehicle has completely entered the parking space.
- 5 Stop the vehicle in an appropriate place, and finish parking.

■ Panoramic view & rear view/wide rear view

The screen can be displayed when the shift lever is in R.

■ Guide lines

If the back door is not closed, guide lines will not be displayed. If the guide lines do not display even when the back door is closed, have the vehicle inspected at your Toyota dealer.

■ Intuitive parking assist pop-up display

→P. 272

⚠ WARNING**■ Guide lines**

The tire position indicator lines and vehicle position indicator lines may differ from actual vehicle positions depending on the number of passengers, cargo weight, road grade, road surface conditions, brightness of the surrounding environment, etc. Always drive the vehicle while confirming the safety of your surroundings.

■ When using panoramic view & rear view or wide rear view

- If the vehicle width extension guide lines and projected course lines are not aligned with the steering wheel in the center position, drive straight on a road without as little traffic and as few bends or curves as possible for approximately 5 minutes or more. If the symptom is not resolved, have the vehicle inspected by your Toyota dealer.
- Rear vehicle width extension guide lines are displayed wider than the actual vehicle width. When backing up, always confirm the safety of your surroundings and the area to the rear of the vehicle.

■ **Display when the outside rear view mirrors are retracted (side view and dual side view)**

When the outside rear view mirrors are retracted, one of the following screens is displayed and assists the driver to confirm the safety of the area around the vehicle, or park alongside and close to another object.

● **Screen description**

▶ When the wide front view is displayed

▶ When the rear view is displayed

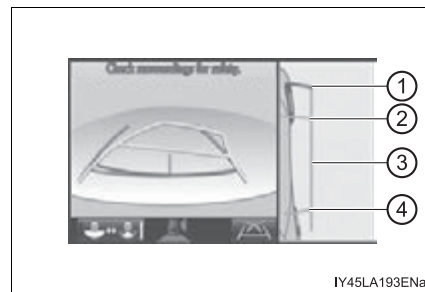
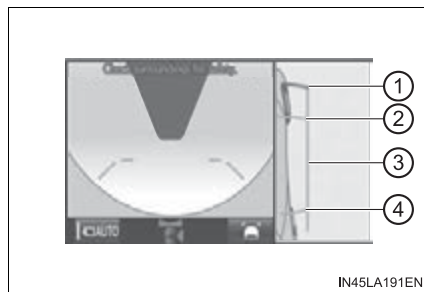

▶ When the dual side view is displayed

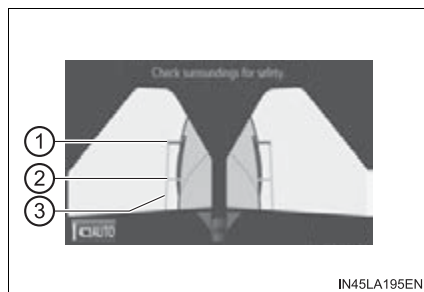

For information about other than the side view and dual side view display area, refer to the page for the respective screen.

- ① Front distance guide line (red)
Indicates a distance approximately 1.5 ft. (0.5 m) from the front end of the vehicle.
- ② Front tire contact line (blue)
Indicates the estimated front tire position on the image.
- ③ Vehicle width lines (blue)
Indicate the estimated vehicle width including the outside rear view mirrors.
- ④ Rear tire contact line (blue)
Indicates the estimated rear tire position on the image.

- Using the vehicle width lines

The relative distance of obstacles from the vehicle width lines can be confirmed.

- Approach the shoulder, but do not allow the vehicle width line to overlap the curb or other obstacles.
- After confirming the distance to the shoulder, maneuvering the vehicle so that the vehicle width line and the curb or other obstacle are parallel allows the vehicle to be parked evenly.

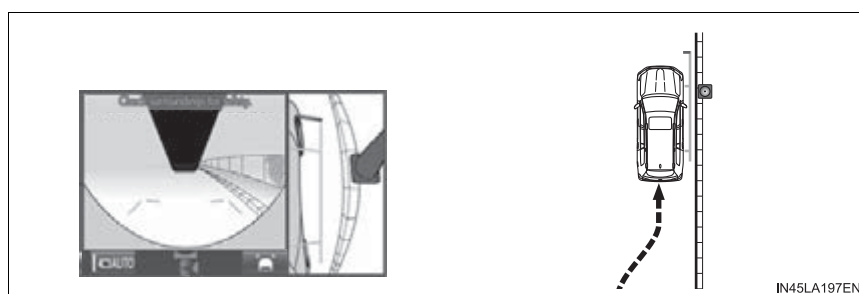

- Intuitive parking assist pop-up display

→P. 272

⚠ WARNING

■ **Guide lines**

The tire position indicator lines and vehicle position indicator lines may differ from actual vehicle positions depending on the number of passengers, cargo weight, road grade, road surface conditions, brightness of the surrounding environment, etc. Always drive the vehicle while confirming the safety of your surroundings.

■ Intuitive parking assist and RCTA cooperative display

When either the Intuitive parking assist (→P. 272) or Blind Spot Monitor (→P. 343) is turned on, a popup icon warns the driver when an obstacle is detected.

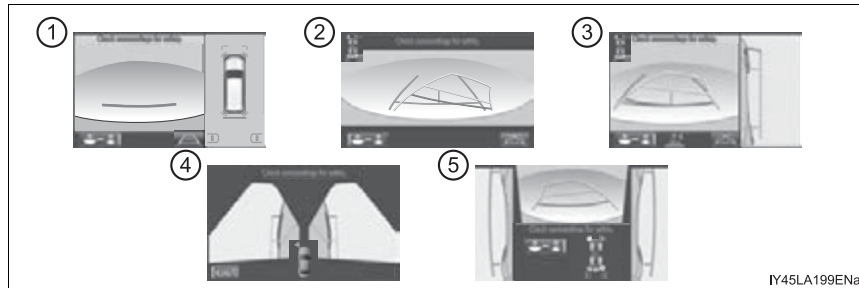

- ① Example of pop-up display in the panoramic view
- ② Example of pop-up display in the wide rear view
- ③ Example of pop-up display in the side view (with mirrors retracted)
- ④ Example of pop-up display in the dual side view
- ⑤ Example of pop-up display in the front view & dual side view, under vehicle terrain view & dual side view or rear view & dual side view

■ Intuitive parking assist pop-up display

While the intuitive parking assist is in use, a pop-up is displayed when an obstacle is detected (→P. 272).

However, this function only informs the driver that an obstacle is close to the vehicle and the detected obstacle is not displayed on the screen. Be sure to visually confirm the safety of your surroundings.

When using the Multi-terrain Monitor

Observe the following precautions. Failure to do so may result in an unexpected accident. Also, when driving, make sure to directly confirm the safety of your surroundings and the area to the rear of the vehicle.

⚠ WARNING**■ Conditions under which the Multi-terrain Monitor should not be used**

Do not use the Multi-terrain Monitor in the following situations. The system may not operate properly, resulting in an unexpected accident.

- When driving on an icy, snow-covered or otherwise slippery road surface
- When using tire chains or a spare tire
- When either front door or the back door is not completely closed
- When driving on an uneven road, such as a hill
- When tires or suspension parts other than those specified are equipped
When the tires are replaced, the position indicated by the guide lines displayed on the screen may differ.

■ Guide lines

The tire position indicator lines and vehicle position indicator lines may differ from actual vehicle positions depending on the number of passengers, cargo weight, road grade, road surface conditions, brightness of the surrounding environment, etc. Always drive the vehicle while confirming the safety of your surroundings.

 NOTICE**■ Panoramic view**

- In the panoramic view, the system combines images taken from the front, back, left and right side cameras into a single image. There are limits to the range and content that can be displayed. Understand the characteristics of this system before using.
- Image clarity may decline at the four corners of the panoramic view. However, this is not a malfunction, as these are the regions along the border of each camera image where the images are combined.
- Depending on lighting conditions near each of the cameras, bright and dark patches may appear on the panoramic view.
- The panoramic view display does not extend higher than the installation position and image capture range of each camera.
- There are blind spots around the vehicle and there are regions that are not displayed in the panoramic view.
- Three-dimensional objects displayed in wide front view or rear view may not be displayed in the panoramic view.
- People and other three-dimensional obstacles may appear differently when displayed in the panoramic view. (These differences include, among others, cases in which displayed objects appear to have fallen over, disappear near image processing areas, appear from image processing areas, or when the actual distance to an object differs from the displayed position.)
- The panoramic view will not be properly displayed when either front door or the back door is open.
- The vehicle icon displayed in the panoramic view is a computer generated image, and properties such as the color, shape and size will differ from the actual vehicle. Therefore, nearby three-dimensional objects may appear to be touching the vehicle, and actual distances to three-dimensional objects may differ from those displayed.

■ Display range

● Panoramic view

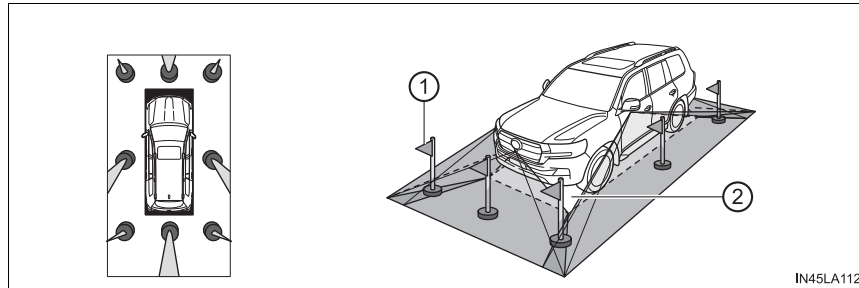

- ① Not displayed.
- ② Not displayed. (Displayed in black around the vehicle icon.)

● Wide front view

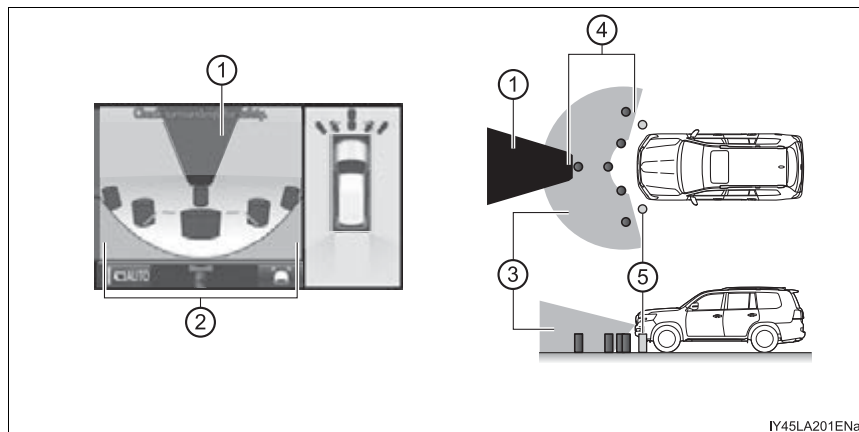

- ① Masking
- ② Parts of the vehicle (such as the bumper or grille) are displayed on the screen.
- ③ Camera visibility range
- ④ Object detectable by camera
- ⑤ Object not detectable by camera

● Dual side view

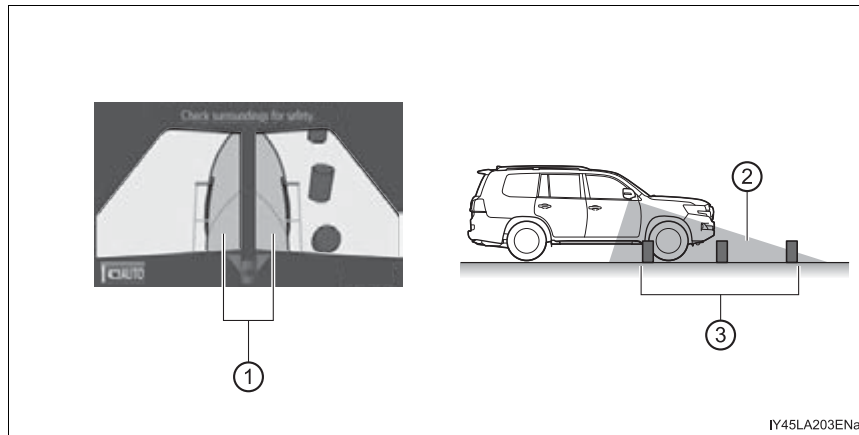

- ① The side of the vehicle is displayed on the screen.
- ② Camera visibility range
- ③ Object detectable by camera

● Side view

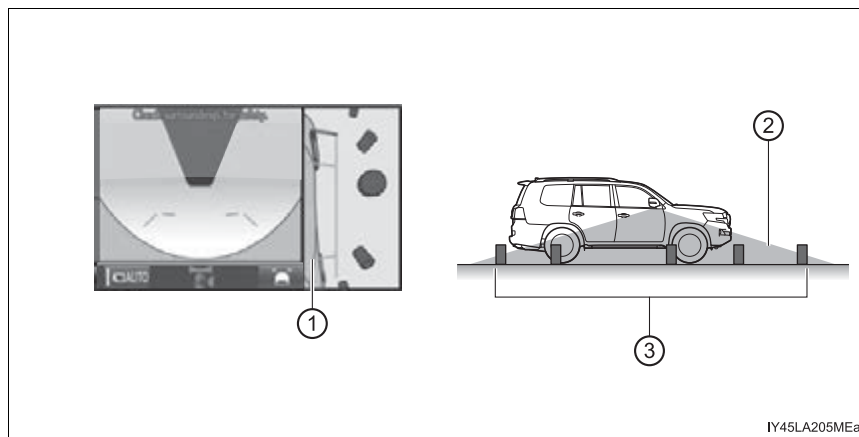

- ① The side of the vehicle is displayed on the screen.
- ② Camera visibility range
- ③ Object detectable by camera

● Rear view

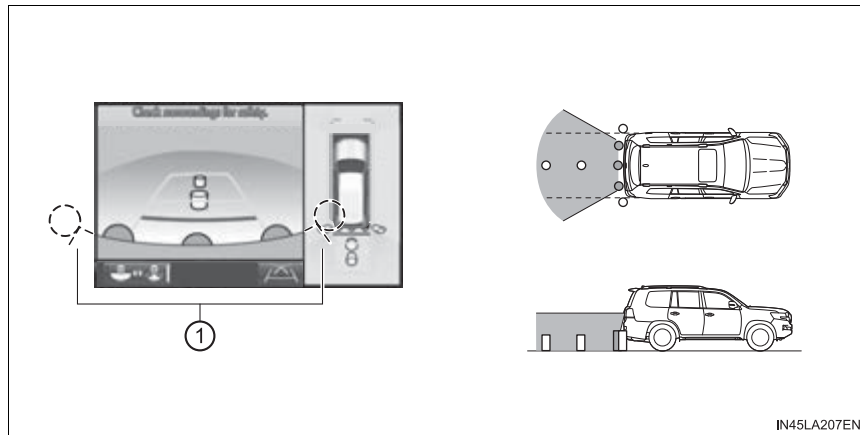

① The corners of the bumper are not seen on the screen.

● Wide rear view

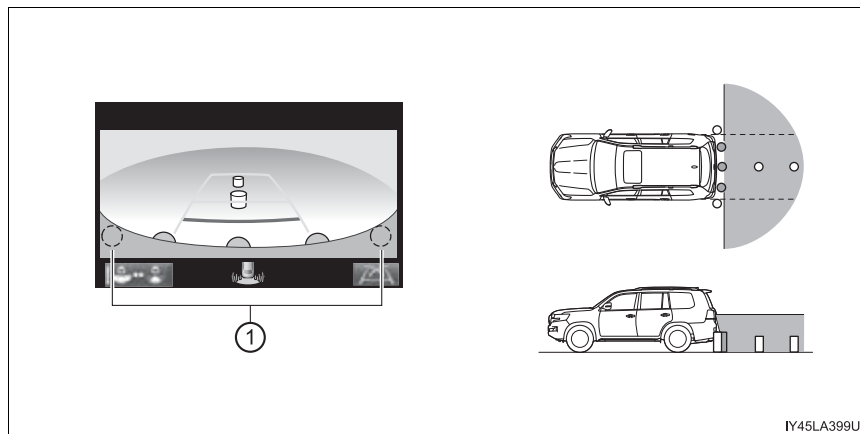

① The corners of the bumper are not seen on the screen.

■ Panoramic view display range

- In the panoramic view, the system processes and displays images acquired from the 4 cameras under the assumption that the vehicle is on a flat road surface. Therefore, the display may appear as follows.
 - Three-dimensional objects may appear to have fallen over, and be long and thin or bigger than they actually are
 - Three-dimensional objects at a point higher than the surface of the road may appear further away than they actually are, or may not appear
 - Tall objects may appear to emerge from the image processing seams
- Inconsistencies in the brightness of images from each camera may occur depending on lighting conditions.
- The displayed image may not be aligned when the tilt or height of the vehicle changed due to the number of passengers, cargo weight or remaining quantity of gasoline.
- Images and guide lines may not be properly displayed when the doors are not completely closed.
- The relative distances between the vehicle icon and road surface or an obstacle displayed in the panoramic view may differ from the actual state.
- If an illuminated license plate is used, it may appear on the screen.
- The black area around the vehicle icon is an area that is not appear in the camera. Check these areas directly.
- The circled areas shown in the illustration may be difficult to see, as these are points where images are combined.

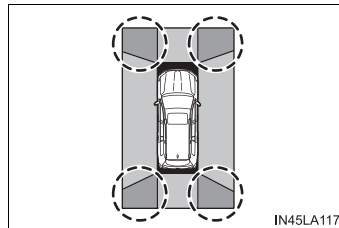

■ Wide front view display range

- Certain areas at the front of the vehicle have a different sense of distance, and are masked in black so that they do not appear on the screen.
- There are limits to the range displayed on the screen. Objects at either corner of the bumper or directly below the bumper are not displayed.
- The perceived distance in images displayed on the screen differs from the actual distance.

■ Images displayed on the screen

Cameras of the Multi-terrain Monitor system use special lenses. The distance of the image that appears on the screen differs from the actual distance.

■ Multi-terrain Monitor cameras**● Camera positions**

The cameras of the Multi-terrain Monitor system are installed as follows.

- ① Side camera (left and right sides)
- ② Front camera
- ③ Rear camera

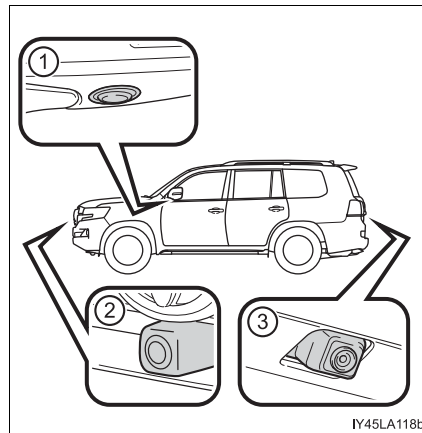
**● Using the cameras**

If dirt or foreign matter (such as water droplets, snow, mud, etc.) is adhering to the camera, it cannot transmit a clear image. In this case, flush it with a large quantity of water and wipe the camera lens with a soft and wet cloth.

 NOTICE**■ How to use the cameras**

- Observe the following precautions. Failure to do so may prevent the Multi-terrain Monitor from operating properly.
 - Do not strike the camera area, or allow any objects to bump into it
If the camera or surrounding area has received a strong impact, the camera position, installation angle, etc., may deviate. If the camera is accidentally subjected to an impact, have the vehicle inspected at your Toyota dealer.
 - Do not remove, disassemble or modify the camera or surrounding parts
Doing so may result in the camera malfunctioning. This also may result in a loss of waterproof performance.
 - If the camera lens is dirty, follow the above procedures to clean it
If the camera lens is damaged it cannot transmit a clear image.
Do not allow organic solvent, car wax, oil film remover, glass coating, etc. to contact the camera cover
Doing so will negatively affect the camera cover (resin). If this happens, wipe it off immediately.
 - When the outside temperature is cold, do not cause any sudden changes in temperature, such as by applying hot water
- When washing the vehicle, do not apply water with a high-pressure washer to the camera or surrounding area. Doing so may cause the camera to receive a strong impact, and the camera may not operate properly

■ Differences between the panoramic view screen and the actual road

The distance guide lines, the combined panoramic view image, guide lines, etc., indicate estimated distances on a flat road surface. In the following situations, actual distances and vehicle course will differ from the guide lines on the screen.

● When the ground behind the vehicle slopes up sharply

The distance guide lines will appear to be closer to the vehicle than the actual distance. Therefore, obstacles on an upward slope appear further away than they actually are. In the same way, the actual course of the vehicle will differ from the course indicated by the guide lines.

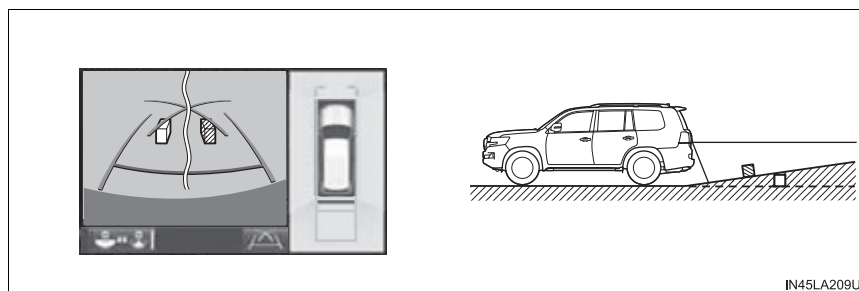

● When the ground behind the vehicle slopes down sharply

The distance guide lines are displayed further away than the actual distance. Therefore, obstacles on a downward slope appear closer than the actually are. In the same way, the actual course of the vehicle will differ from the course indicated by the guide lines.

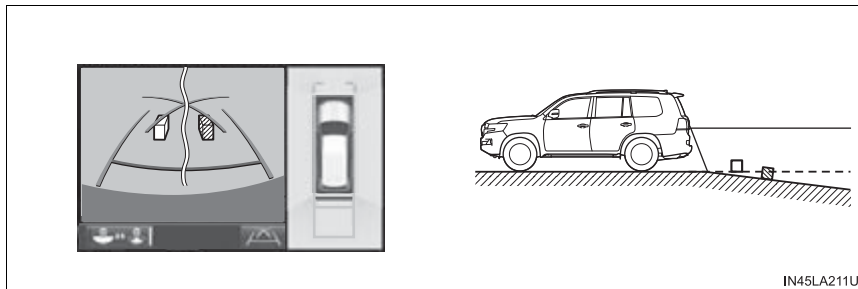

● When the vehicle is tilted

When the vehicle is tilted due to the number of passengers or weight of the load, actual distances and vehicle course will differ.

① Margin of error

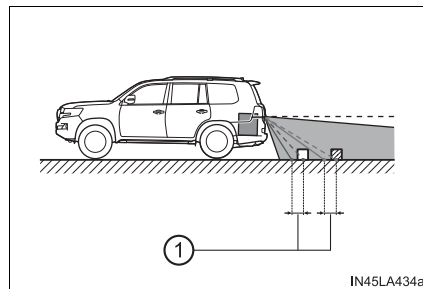

■ Differences between the panoramic view display and actual three-dimensional objects

Be aware of the following points when three-dimensional objects higher than the surface of the road (such as a vehicle bumper) are nearby.

● Panoramic view display

In the panoramic view, the system processes and displays images under the assumption that the vehicle is on a flat road surface. Therefore, the position of three-dimensional objects higher than the road surface (such as a vehicle bumper) cannot be determined. Even if it seems that a collision will not occur according to the screen, there may not actually be any extra space between the vehicle and an obstacle higher than the road surface, resulting in a collision. In these cases, confirm the safety of your surroundings directly.

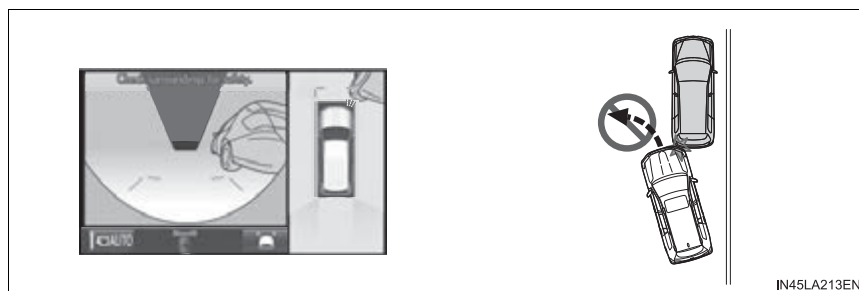

⚠ WARNING

■ Intuitive parking assist pop-up display

When the intuitive parking assist pop-up display is red, park the vehicle and make sure to confirm the safety of your surroundings.

Failure to do so may lead to an unexpected accident.

● Projected course lines

Projected course lines are displayed under the assumption that the vehicle is on a flat road surface. Therefore, the position of three-dimensional objects higher than the road surface (such as a vehicle bumper) cannot be determined. Even if it seems that an obstacle is outside of the projected course lines and a collision will not occur according to the screen, an obstacle may actually be in the vehicle course, resulting in a collision.

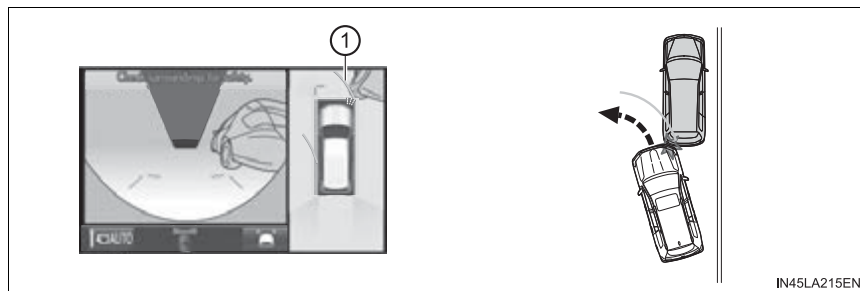

① Projected course lines

Three-dimensional objects in high positions (such as walls with protrusions or the loading areas of trucks) may not be displayed on the screen. Confirm the safety of your surroundings directly.



① Protrusion of a wall

■ Differences between the rear view or wide rear view and actual roads

The guide lines on the screen are intended for flat surfaces (such as the road). Be aware of the following points when three-dimensional objects with protrusions (obstacles such as the cargo bed of a truck) are nearby.

● Projected course lines

Guide lines are displayed in reference to a level road surface and cannot be used to determine the location of three-dimensional objects. Confirm the safety of your surroundings directly. Even if it seems that the cargo bed of a truck is outside the projected course lines and a collision will not occur according to the screen, it may actually be in the vehicle course, resulting in a collision.

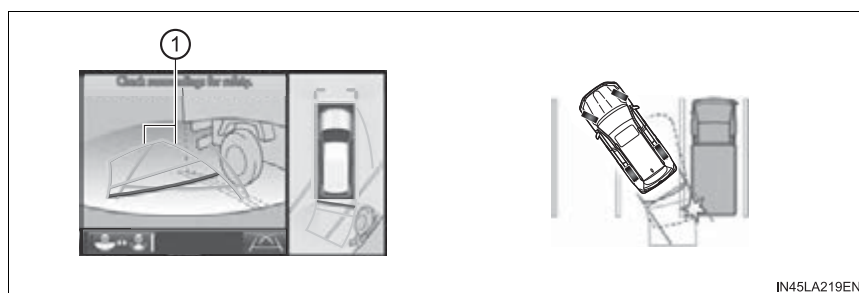

① Projected course lines

■ Differences between the panoramic view, rear view and wide rear view and actual roads

● Distance guide lines

Guide lines are displayed in reference to the road surface and cannot be used to determine the distance of three-dimensional objects from the vehicle. Confirm the safety of your surroundings directly. On the screen, it appears that a truck is parking at point ② according to the distance guide lines. However, in reality if you back up to point ①, you will hit the truck. On the screen, it appears that ① is closest and ③ is farthest away. However, in reality, the distance to ① and ③ is same, and ② is farther than ① and ③.

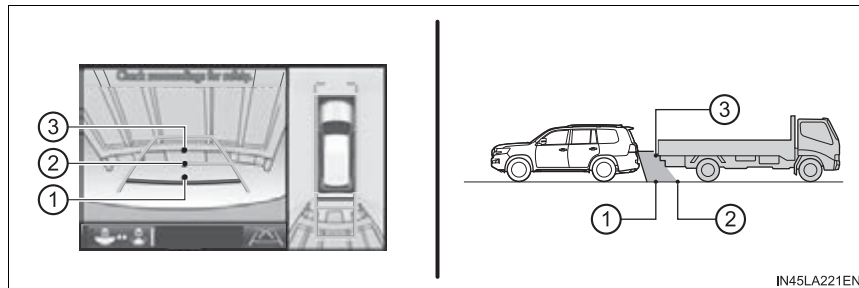

IN45LA221EN

● Under vehicle terrain view

The tire position indicator lines and vehicle position indicator lines may differ from actual vehicle positions depending on the number of passengers, weight of the load, road grade, road surface conditions, brightness of the surrounding environment, etc. Always drive the vehicle while directly confirming the safety of your surroundings.

■ Using under vehicle terrain view

- The images displayed were previously taken approximately 10 ft. (3 m) behind the current vehicle position. Therefore, actual conditions may differ from those shown on the screen in the following situations.
 - An obstacle has appeared after the image was taken
 - Loose material like sand or snow has crumbled or shifted
 - An obstacle has moved
 - There is a puddle, tract of mud, etc., within the display range
 - The vehicle slips
- In the following situations, actual tire positions and vehicle position may differ from those indicated by the tire position indicator lines and vehicle position indicator lines.
 - Tires have been replaced
 - Optional equipment has been installed

**WARNING****■ Guide lines**

The displayed guide lines are composed with the image that was previously taken and may differ from the actual state. Always drive the vehicle while confirming the safety of your surroundings.

■ **If you notice any symptoms**

If you notice any of the following symptoms, refer to the likely cause and the solution, and re-check.

If the symptom is not resolved by the solution, have the vehicle inspected by your Toyota dealer.

Likely cause	Solution
<input type="checkbox"/> The image is difficult to see	
<ul style="list-style-type: none"> • The vehicle is in a dark area • The temperature around the lens is either high or low • The outside temperature is low • There are water droplets on the camera • It is raining or humid • Foreign matter (mud etc.) is adhering to the camera • Sunlight or headlights are shining directly into the camera • The vehicle is under fluorescent lights, sodium lights, mercury lights, etc. 	<p>Drive while visually checking the vehicle's surroundings. (Use the Multi-terrain Monitor again once conditions have been improved.)</p> <p>The image on the rear view monitor system screen can be adjusted, refer to the "Navigation system Owner's manual", "Multimedia Owner's Manual" or "Navigation and Multimedia System Owner's Manual".</p>
<input type="checkbox"/> The image is blurry	
Dirt or foreign matter (such as water droplets, snow, mud, etc.) is adhering to the camera	Flush the camera with a large quantity of water and wipe the camera lens with a soft and wet cloth.
<input type="checkbox"/> The image is out of alignment	
The camera or surrounding area has received a strong impact	Have the vehicle inspected by your Toyota dealer.
<input type="checkbox"/> The guide lines are very far out of alignment	
The camera position is out of alignment	Have the vehicle inspected at your Toyota dealer.
<ul style="list-style-type: none"> • The vehicle is tilted (there is a heavy load on the vehicle, tire pressure is low due to a tire puncture, etc.) • The vehicle is used on an incline 	<p>If this happens due to these causes, it does not indicate a malfunction.</p> <p>Drive while visually checking the vehicle's surroundings.</p>

Likely cause	Solution
<input type="checkbox"/> The projected course lines move even though the steering wheel is straight (vehicle width extension guide lines and projected course lines are not aligned)	
There is a malfunction in the signals being output by the steering sensor	Have the vehicle inspected by your Toyota dealer.
<input type="checkbox"/> Guide lines are not displayed	
The back door is open	Close the back door. If this does not resolve the symptom, have the vehicle inspected by your Toyota dealer.
<input type="checkbox"/> "!" is displayed	
There is a malfunction in the Multi-terrain Monitor	Have the vehicle inspected by your Toyota dealer.
The battery is disconnected and reconnected	Turn the steering wheel fully to right and left. If this does not resolve the symptom, have the vehicle inspected by your Toyota dealer.

 NOTICE**■ How to use the camera**

- The Multi-terrain Monitor system may not operate properly in the following cases.
 - If the front or the rear of the vehicle or the outside rear view mirror has been hit, the camera's position and mounting angle may have changed.
 - As the camera has a water proof construction, do not detach, disassemble or modify it. This may cause incorrect operation.
 - Do not strongly rub the camera lens. If the camera lens is scratched, it cannot transmit a clear image.
 - Do not allow organic solvent, car wax, window cleaner or glass coat to adhere to the camera. If this happens, wipe it off as soon as possible.
 - If the temperature changes rapidly, such as when hot water is poured on the vehicle in cold weather, the system may not operate normally.
 - When washing the vehicle, do not apply intensive bursts of water to the camera or camera area. Doing so may result in the camera malfunctioning.
 - When the camera is used under fluorescent lights, sodium light or mercury light etc., the lights and the illuminated areas may appear to flicker.
 - The camera can be damaged by flying rocks and other debris.
- Do not expose the camera to strong impact as this could cause a malfunction. If this happens, have the vehicle inspected by your Toyota dealer as soon as possible.

BSM (Blind Spot Monitor)*

Summary of the Blind Spot Monitor

The Blind Spot Monitor is a system that has 2 functions;

- The BSM (Blind Spot Monitor) function
Assists the driver in making the decision when changing lanes
- The RCTA (Rear Cross Traffic Alert) function
Assists the driver when backing up

These functions use same sensors.

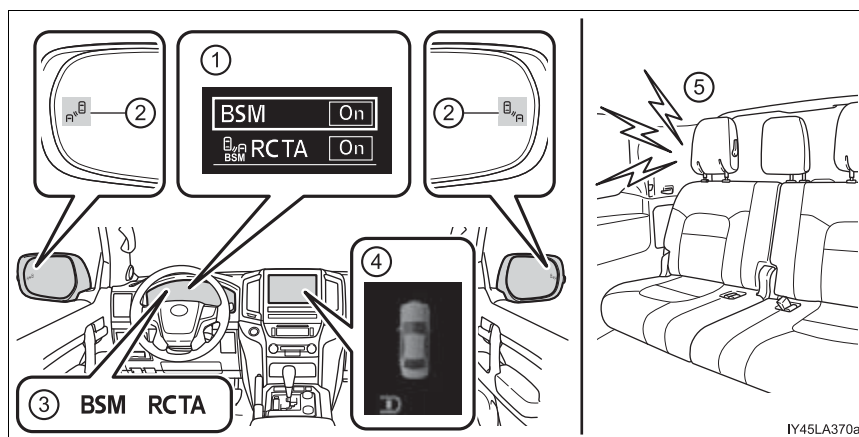

4
Driving

*: If equipped

① Multi-information display

Turning the BSM function/RCTA function on/off. (→P. 345)

② Outside rear view mirror indicator

BSM function:

When a vehicle is detected in a blind spot of the outside rear view mirrors or approaching rapidly from behind into a blind spot, the outside rear view mirror indicator on the detected side will illuminate. If the turn signal lever is operated toward the detected side, the outside rear view mirror indicator will flash.

RCTA function:

When a vehicle approaching from the right or left rear of the vehicle is detected, the outside rear view mirror indicators flash.

③ “BSM” indicator/“RCTA” indicator

When the BSM function/RCTA function is turned on, the indicator illuminates





④ Monitor screen display (RCTA function only)

If a vehicle approaching from the right or left at the rear of the vehicle is detected, the RCTA icon (→P. 352) for the detected side will be displayed on the monitor screen. This illustration shows an example of a vehicle approaching from the left at the rear of the vehicle.

⑤ RCTA buzzer (RCTA function only)

If a vehicle approaching from the right or left at the rear of the vehicle is detected, a buzzer will sound. The buzzer also sounds for approximately 1 second immediately after the BSM function is operated to turn the system on.

Turning the BSM function/RCTA function on/off

- 1 Use the meter control switches to select  on the multi-information display.
- 2 Choose “BSM” using , and then press .
- 3 Choose “BSM” or “RCTA” using , and then press .

■ The outside rear view mirror indicators visibility

When under strong sunlight, the outside rear view mirror indicator may be difficult to see.

■ RCTA buzzer hearing

RCTA buzzer may be difficult to hear over loud noises such as high audio volume.

■ When “Blind Spot Monitor Unavailable” is shown on the multi-information display

Water, snow, mud, etc., may be built up in the vicinity of the sensor area of bumper. (→P. 346)

Removing the water, snow, mud, etc., from the vicinity of the sensor area bumper should return it to normal.

Also, the sensor may not function normally when used in extremely hot or cold weather.

■ When “Blind Spot Monitor System Malfunction” is shown on the multi-information display

There may be a sensor malfunction or voltage abnormality. Have the vehicle inspected at your Toyota dealer.

■ Certification for the Blind Spot Monitor

FCC ID : QAYSRR3A

This device complies with part 15 of the FCC Rules. Operation is subject to the following two conditions:
 (1) This device may not cause harmful interference, and
 (2) this device must accept any interference received, including interference that may cause undesired operation.

FCC Warning

Changes or modifications not expressly approved by the party responsible for compliance could void the user's authority to operate the equipment.

⚠ WARNING**■ Handling the radar sensor**

One Blind Spot Monitor sensor is installed inside the left and right side of the vehicle rear bumper respectively. Observe the following to ensure the Blind Spot Monitor can function correctly.

- Keep the sensor and its surrounding area on the bumper clean at all times.

If a sensor or its surrounding area on the rear bumper is dirty or covered with snow, the Blind Spot Monitor may not operate and a warning message (→P. 345) will be displayed. In this situation, clear off the dirt or snow and drive the vehicle with the operation conditions of the BSM function (→P. 349) satisfied for approximately 10 minutes. If the warning message does not disappear, have the vehicle inspected by your Toyota dealer.

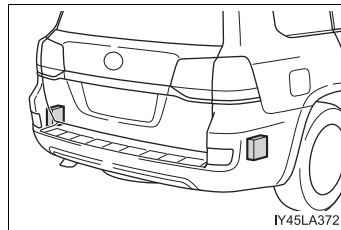

- Do not subject a sensor or its surrounding area on the rear bumper to a strong impact.

If a sensor is moved even slightly off position, the system may malfunction and vehicles may not be detected correctly. In the following situations, have your vehicle inspected by your Toyota dealer.

 - A sensor or its surrounding area is subject to a strong impact.
 - If the surrounding area of a sensor is scratched or dented, or part of it has become disconnected.
- Do not disassemble the sensor.
- Do not attach accessories or stickers to the sensor or surrounding area on the bumper.
- Do not modify the sensor or surrounding area on the bumper.
- Do not paint the sensor or surrounding area on the bumper.

BSM function

The BSM function uses radar sensors to detect the following vehicles traveling in adjacent lanes and advises the driver of the presence of such vehicles via the indicators on the outside rear view mirrors.

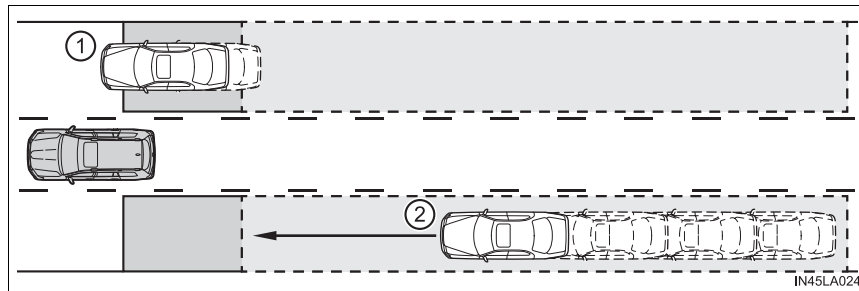

- ① Vehicles that are traveling in areas that are not visible using the outside rear view mirrors (the blind spots)
- ② Vehicles that are approaching rapidly from behind in areas that are not visible using the outside rear view mirrors (the blind spots)

BSM function detection areas

The areas that vehicles can be detected in are outlined below.

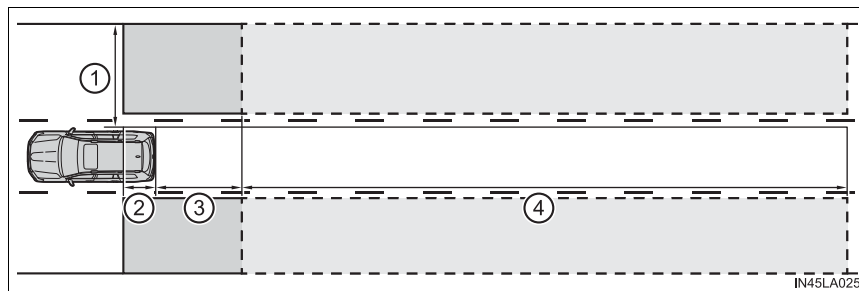

The range of each detection area is:

- ① Approximately 1.6 ft. (0.5 m) to 11.5 ft. (3.5 m) from either side of the vehicle*
- ② Approximately 3.3 ft. (1 m) forward of the rear bumper
- ③ Approximately 9.8 ft. (3 m) from the rear bumper
- ④ Approximately 9.8 ft. (3 m) to 197 ft. (60 m) from the rear bumper*

*: The area between the side of the vehicle and 1.6 ft. (0.5 m) from the side of the vehicle cannot be detected.

*: The greater the difference in speed between your vehicle and the detected vehicle is, the farther away the vehicle will be detected, causing the outside rear view mirror indicator to illuminate or flash.

⚠ WARNING

■ Cautions regarding the use of the system

The driver is solely responsible for safe driving. Always drive safely, taking care to observe your surroundings.

The Blind Spot Monitor function is a supplementary function which alerts the driver that a vehicle is present in the blind spot. Do not overly rely on the Blind Spot Monitor function. The function cannot judge if it is safe to change lanes, therefore over reliance could cause an accident resulting in death or serious injury.

According to conditions, the system may not function correctly. Therefore the driver's own visual confirmation of safety is necessary.

■ The BSM function is operational when

The BSM function is operational when all of the following conditions are met:

- The BSM main switch is on.
- The shift lever is in a position other than R.
- The vehicle speed is greater than approximately 16 km/h (10 mph).

■ The BSM function will detect a vehicle when

The BSM function will detect a vehicle present in the detection area in the following situations:

- A vehicle in an adjacent lane overtakes your vehicle.
- Another vehicle enters the detection area when it changes lanes.

■ Conditions under which the BSM function will not detect a vehicle

The BSM function is not designed to detect the following types of vehicles and/or objects:

- Small motorcycles, bicycles, pedestrians, etc.*
- Vehicles traveling in the opposite direction
- Guardrails, walls, signs, parked vehicles and similar stationary objects*
- Following vehicles that are in the same lane*
- Vehicles traveling 2 lanes away from your vehicle*

*: Depending on the conditions, detection of a vehicle and/or object may occur.

■ Conditions under which the BSM function may not function correctly

- The BSM function may not detect vehicles correctly in the following situations:
 - When the sensor is misaligned due to a strong impact to the sensor or its surrounding area
 - When mud, snow, ice, a sticker, etc. is covering the sensor or surrounding area on the rear bumper
 - When driving on a road surface that is wet with standing water during bad weather, such as heavy rain, snow, or fog
 - When multiple vehicles are approaching with only a small gap between each vehicle
 - When the distance between your vehicle and a following vehicle is short
 - When there is a significant difference in speed between your vehicle and the vehicle that enters the detection area
 - When the difference in speed between your vehicle and another vehicle is changing
 - When a vehicle enters a detection area traveling at about the same speed as your vehicle
 - As your vehicle starts from a stop, a vehicle remains in the detection area
 - When driving up and down consecutive steep inclines, such as hills, dips in the road, etc.
 - When driving on roads with sharp bends, consecutive curves, or uneven surfaces
 - When vehicle lanes are wide, or when driving on the edge of a lane, and the vehicle in an adjacent lane is far away from your vehicle
 - When a bicycle carrier or other accessory is installed to the rear of the vehicle
 - When there is a significant difference in height between your vehicle and the vehicle that enters the detection area
 - Immediately after the BSM main switch is turned on
- Instances of the BSM function unnecessarily detecting a vehicle and/or object may increase in the following situations:
 - When the sensor is misaligned due to a strong impact to the sensor or its surrounding area
 - When the distance between your vehicle and a guardrail, wall, etc. that enters the detection area is short
 - When driving up and down consecutive steep inclines, such as hills, dips in the road, etc.
 - When vehicle lanes are narrow, or when driving on the edge of a lane, and a vehicle traveling in a lane other than the adjacent lanes enters the detection area
 - When driving on roads with sharp bends, consecutive curves, or uneven surfaces
 - When the tires are slipping or spinning
 - When the distance between your vehicle and a following vehicle is short
 - When a bicycle carrier or other accessory is installed to the rear of the vehicle

RCTA function



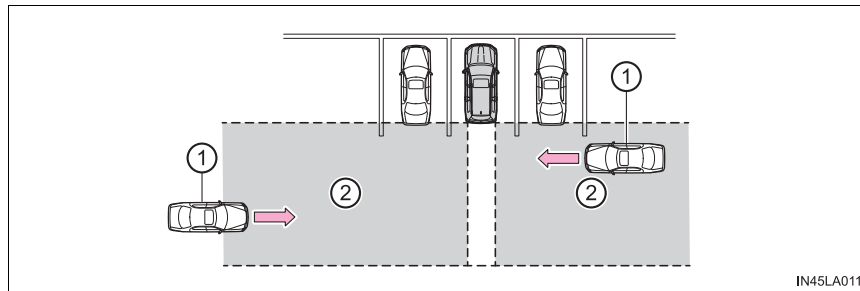

The Rear Cross Traffic Alert functions when your vehicle is in reverse. It can detect other vehicles approaching from the right or left rear of the vehicle. It uses radar sensors to alert the driver of the other vehicle's existence through flashing the outside rear view mirror indicators and sounding a buzzer.



① Approaching vehicles ② Detection areas

■ **RCTA icon display**

When a vehicle approaching from the right or left at the rear of the vehicle is detected, the following will be displayed on the monitor screen

Display	Content
	<p>A vehicle is approaching from the left at the rear of the vehicle</p>
	<p>A vehicle is approaching from the right at the rear of the vehicle</p>
	<p>Vehicles are approaching from both sides of the vehicle</p>
	<p>The RCTA function is malfunctioning (→P. 345)</p>

⚠ WARNING

■ **Cautions regarding the use of the function**

The driver is solely responsible for safe driving. Always drive safely, taking care to observe your surroundings.

The RCTA function is only a supplementary function which alerts the driver that a vehicle is approaching from the right or left at the rear of the vehicle. As the RCTA function may not function correctly under certain conditions, the driver's own visual confirmation of safety is necessary. Over reliance on this function may lead to an accident resulting death or serious injury.

The RCTA function detection areas

The areas that vehicles can be detected in are outlined below.

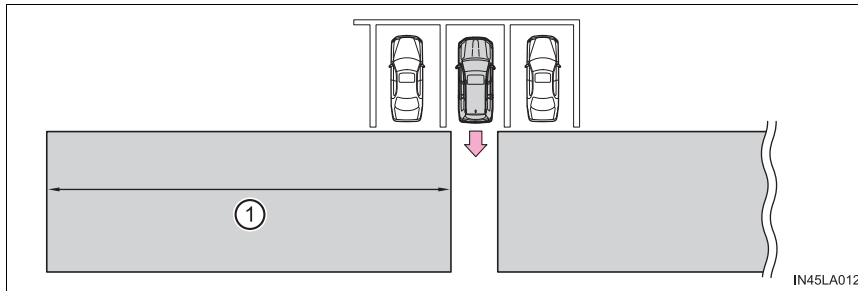

To give the driver a more consistent time to react, the buzzer can alert for faster vehicles from farther away.

Example:

Approaching vehicle	Speed	① Approximate alert distance
Fast	18 mph (28 km/h)	65 ft. (20 m)
Slow	5 mph (8 km/h)	18 ft. (5.5 m)

4
Driving

■ **The Rear Cross Traffic Alert function is operational when**

- The Blind Spot Monitor system turned on.
- The shift lever is in R.
- Vehicle speed is less than approximately 5 mph (8 km/h).
- Approaching vehicle speed is between approximately 5 mph (8 km/h) and 18 mph (28 km/h).

■ **Conditions under which the Rear Cross Traffic Alert function will not detect a vehicle**

The Rear Cross Traffic Alert function is not designed to detect the following types of vehicles and/or objects:

- Vehicles approaching from directly behind
- Vehicles backing up in a parking space next to your vehicle
- Vehicles that the sensors cannot detect due to obstructions

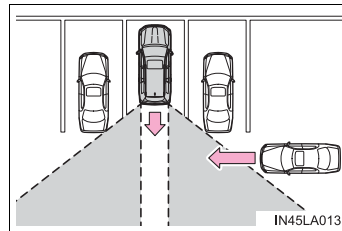

- Guardrails, walls, signs, parked vehicles and similar stationary objects*
- Small motorcycles, bicycles, pedestrians, etc.*
- Vehicles moving away from your vehicle
- Vehicles approaching from the parking spaces next to your vehicle*

*: Depending on the conditions, detection of a vehicle and/or object may occur.

■ **Conditions under which the Rear Cross Traffic Alert function may not function correctly**

- The Rear Cross Traffic Alert function may not detect vehicles correctly in the following situations:
 - When the sensor is misaligned due to a strong impact to the sensor or its surrounding area
 - When mud, snow, ice, a sticker, etc. is covering the sensor or surrounding area on the rear bumper
 - When driving on a road surface that is wet with standing water during bad weather, such as heavy rain, snow, or fog
 - When multiple vehicles are approaching with only a small gap between each vehicle
 - When a vehicle is approaching at high speed
 - When backing up on a slope with a sharp change in grade

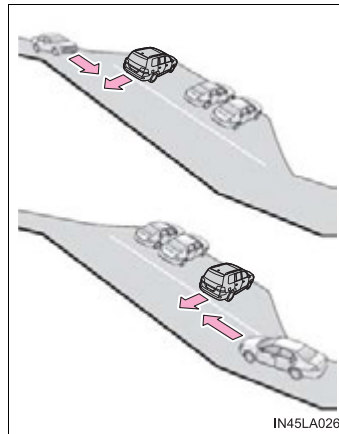

- When backing out of a shallow angle parking spot

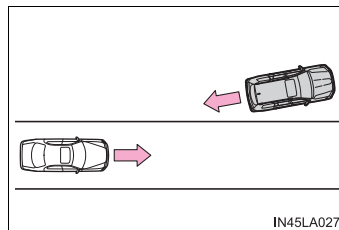

- Immediately after the BSM main switch is turned on
- Immediately after the engine is started with the BSM main switch on
- When the sensors cannot detect a vehicle due to obstructions

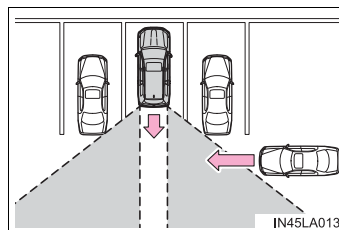

● Instances of the Rear Cross Traffic Alert function unnecessarily detecting a vehicle and/or object may increase in the following situations:

- When a vehicle passes by the side of your vehicle
- When the parking space faces a street and vehicles are being driven on the street

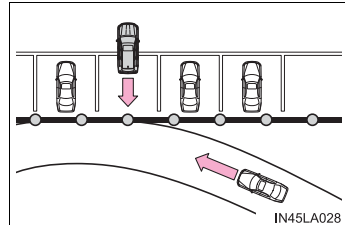

- When the distance between your vehicle and metal objects, such as a guardrail, wall, sign, or parked vehicle, which may reflect electrical waves toward the rear of the vehicle, is short

Driving assist systems

To help enhance driving safety and performance, the following systems operate automatically in response to various driving situations. Be aware, however, that these systems are supplementary and should not be relied upon too heavily when operating the vehicle.

◆ Multi Terrain ABS (Anti-lock Brake System)

Helps to prevent wheel lock when the brakes are applied suddenly, or if the brakes are applied while driving on a slippery road surface, or in off-road conditions (such as rough roads, sand and mud)

◆ Brake assist

Generates an increased level of braking force after the brake pedal is depressed when the system detects a panic stop situation

◆ VSC (Vehicle Stability Control)

Helps the driver to control skidding when swerving suddenly or turning on slippery road surfaces

◆ Active TRAC (Traction Control)

Helps to maintain drive power and prevent the 4 wheels from spinning when starting the vehicle or accelerating on slippery roads, or in off-road conditions

◆ Hill-start assist control

Helps to reduce the backward movement of the vehicle when starting on an incline or slippery slope

◆ KDSS (Kinetic Dynamic Suspension System)

KDSS helps to enhance ride comfort and handling response by using a hydraulic control system to control the suspension stabilizer bars in response to road surface and driving conditions during cornering or off-road driving

◆ **VGRS (Variable Gear Ratio Steering)**

Helps to adjust the wheel turning angle in accordance with the vehicle speed and steering wheel movement.

◆ **Trailer Sway Control**

Helps the driver to control trailer sway by selectively applying brake pressure for individual wheels and reducing engine torque when trailer sway is detected.

Trailer Sway Control is part of the VSC system and will not operate if VSC turned off or experiences a malfunction.

When the Active TRAC/VSC/Trailer Sway Control/hill-start assist control systems are operating

The slip indicator light flashes to indicate that the VSC/Trailer Sway Control/Active TRAC/hill-start assist control systems have been engaged.

The stop lights and high mounted stoplight turn on when the hill-start assist control system or Trailer Sway Control is operating.

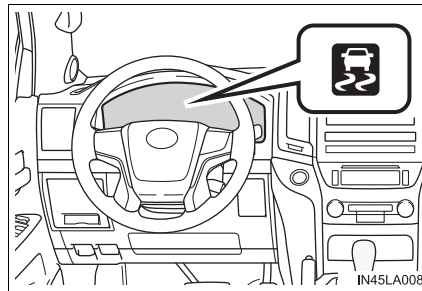

Disabling the Active TRAC

If the vehicle gets stuck in fresh snow or mud, Active TRAC may reduce power from the engine to the wheels. You may need to turn the system off to enable you to rock the vehicle in order to free it.

Quickly push and release the button to turn off Active TRAC.

The TRAC OFF indicator will come on.

This mode can be used when the transfer mode is H4.

Push the button again to turn the system back on.

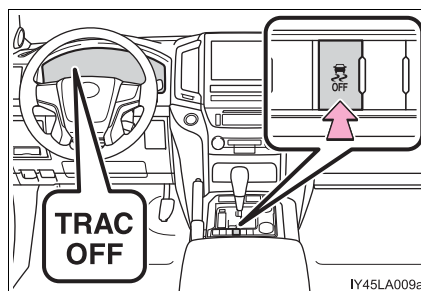

Turning off Active TRAC, VSC and Trailer Sway Control

Push and hold the button for more than 3 seconds while the vehicle is stopped to turn off Active TRAC, VSC and Trailer Sway Control.

The VSC OFF indicator light and TRAC OFF indicator will come on*.

Push the button again to turn the system back on.

*: On vehicles with pre-collision system, pre-collision brake assist and pre-collision braking will also be disabled. The PCS warning light will come on and the message will be shown on the multi-information display. (→P. 233)

When the message is displayed on the multi-information display showing that TRAC has been disabled even if the VSC OFF switch has not been pressed

Active TRAC, hill-start assist control, Crawl Control cannot be operated. Contact your Toyota dealer.

■ Automatic reactivation of Active TRAC, VSC and Trailer Sway Control

Turning the engine switch off after turning off the Active TRAC and VSC systems will automatically re-enable them.

■ Automatic Active TRAC reactivation

If only the Active TRAC system is turned off, the Active TRAC system will turn on when vehicle speed increases.

■ Automatic Active TRAC, VSC and Trailer Sway Control reactivation

If the Active TRAC, VSC and Trailer Sway Control are turned off, the systems will not turn on even when vehicle speed increases.

■ If the brake system overheats

The brake system may overheat. In this case, a buzzer will sound, and the TRAC OFF indicator will flash, and Active TRAC and hill-start assist control will be temporarily inoperable. In this event, stop the vehicle immediately in a safe place, and allow the brake system to cool down sufficiently until the TRAC OFF indicator goes off. (There is no problem with continuing normal driving.)

■ Sounds and vibrations caused by the Multi Terrain ABS, brake assist, Active TRAC, VSC, Trailer Sway Control, hill-start assist control and VGRS

- A sound may be heard from the engine compartment when the engine is started or just after the vehicle begins to move. This sound does not indicate that a malfunction has occurred in any of these systems.
- Any of the following conditions may occur when the above systems are operating. None of these indicates that a malfunction has occurred.
 - Vibrations may be felt through the vehicle body and steering.
 - A motor sound may be heard after the vehicle comes to a stop.
 - The brake pedal may pulsate slightly after the Multi Terrain ABS is activated.
 - The brake pedal may move down slightly after the Multi Terrain ABS is activated.

■ Hill-start assist control is operational when

- The shift lever is in D or S.
- The brake pedal is not depressed.

■ VGRS is disabled in the following situations

- During stopping or the steering wheel has been moved for a long time while driving at lower speeds.
- After the engine is restarted at less than -22°F (-30°C).
- If you disconnect the battery with the steering wheel turned, the center position of the steering wheel could be slightly and temporarily changed. To initialize the VGRS, drive for a short while.

 **WARNING**

Any of the following conditions may result in an accident which could cause death or serious injury:

■ **The Multi Terrain ABS does not operate effectively when**

- The limits of tire gripping performance have been exceeded (such as excessively worn tires on a snow covered road).
- The vehicle hydroplanes while driving at high speed on the wet or slick road.

■ **Stopping distance when the Multi Terrain ABS is operating may exceed that of normal conditions**

The Multi Terrain ABS is not designed to shorten the vehicle's stopping distance. Always maintain a safe distance from the vehicle in front of you, especially in the following situations.

- When driving on dirt, gravel or snow-covered roads
- When driving with tire chains
- When driving over bumps in the road
- When driving over roads with potholes or uneven roads

■ **Active TRAC may not operate effectively when**

Directional control and power may not be achievable while driving on slippery road surfaces, even if the Active TRAC is operating. Do not drive the vehicle in conditions where stability and power may be lost.

■ **If the hill-start assist control does not operate effectively**

Do not overly rely on the hill-start assist control. The hill-start assist control may not operate effectively on steep inclines and roads covered in ice.

■ **When Active TRAC, VSC and Trailer Sway Control are off**

Be especially careful and drive at a speed appropriate to the road conditions. As there are systems to help ensure vehicle stability and driving force, do not turn off Active TRAC, VSC and Trailer Sway Control unless necessary.

**WARNING****■ When the VSC and Trailer Sway Control are activated**

The slip indicator light flashes. Always drive carefully.

Reckless driving may cause an accident. Exercise particular care when the indicator light flashes.

■ Replacing tires

Make sure that all tires are of the same size, brand, tread pattern and total load capacity. In addition, make sure that the tires are inflated to the specified tire pressure level.

The Multi Terrain ABS, Active TRAC, VSC and Trailer Sway Control will not function correctly if different tires are fitted on the vehicle.

Contact your Toyota dealer for further information when replacing tires or wheels.

■ Handling of tires and suspension

Using tires with any kind of problem or modifying the suspension will affect the driving assist systems, and may cause the system to malfunction.

■ Trailer Sway Control precaution

The Trailer Sway Control system is not able to reduce trailer sway in all situations. Depending on many factors such as the conditions of the vehicle, trailer, road surface, and driving environment, the Trailer Sway Control system may not be effective. Refer to your trailer owner's manual for information on how to tow your trailer properly.

■ If trailer sway occurs

Observe the following precautions.

Failing to do so may cause death or serious injury.

● Firmly grip the steering wheel. Steer straight ahead.

Do not try to control trailer swaying by turning the steering wheel.

● Begin releasing the accelerator pedal immediately but very gradually to reduce speed.

Do not increase speed. Do not apply vehicle brakes.

If you make no extreme correction with the steering or brakes, your vehicle and trailer should stabilize. (→P. 189)

 NOTICE■ **KDSS**

In the following situations, there is the possibility that a system malfunction has occurred, and drive comfort and the vehicle's ability to travel on poor road surfaces may be reduced. Take the vehicle to your Toyota dealer immediately.

- When turning a corner, the vehicle's body seems to roll further than normal.
- If after the vehicle has been left in a slanted position for a long time, for example with the wheels of one side parked on a curb, the vehicle does not return to level when driving (the vehicle remains slanted to one side after returning the vehicle to level ground).

Off-road precautions

This vehicle belongs to the utility vehicle class, which has higher ground clearance and narrower tread in relation to the height of its center of gravity to make it capable of performing in a wide variety of off-road applications.

Off-road vehicle features

- Specific design characteristics give it a higher center of gravity than ordinary passenger cars. This vehicle design feature causes this type of vehicle to be more likely to rollover. And, utility vehicles have a significantly higher rollover rate than other types of vehicles.
- An advantage of the higher ground clearance is a better view of the road allowing you to anticipate problems.
- It is not designed for cornering at the same speeds as ordinary passenger cars any more than low-slung sports cars are designed to perform satisfactorily under off-road conditions. Therefore, sharp turns at excessive speeds may cause the vehicle to rollover.

 **WARNING****Off-road vehicle precautions**

Always observe the following precautions to minimize the risk of death, serious injury or damage to your vehicle:

- In a rollover crash, an unbelted person is significantly more likely to die than a person wearing a seat belt. Therefore, the driver and all passengers should always fasten their seat belts.
- Avoid sharp turns or abrupt maneuvers, if at all possible.
Failure to operate this vehicle correctly may result in loss of control or vehicle rollover causing death or serious injury.
- Loading cargo on the roof luggage carrier will make the center of the vehicle gravity higher. Avoid high speeds, sudden starts, sharp turns, sudden braking or abrupt maneuvers, otherwise it may result in loss of control or vehicle rollover due to failure to operate this vehicle correctly.
- Always slow down in gusty crosswinds. Because of its profile and higher center of gravity, your vehicle is more sensitive to side winds than an ordinary passenger car. Slowing down will allow you to have better control.
- Do not drive horizontally across steep slopes. Driving straight up or straight down is preferred. Your vehicle (or any similar off-road vehicle) can tip over sideways much more easily than forward or backward.

Off-road driving

When driving your vehicle off-road, please observe the following precautions to ensure your driving enjoyment and to help prevent the closure of areas to off-road vehicles:

- Drive your vehicle only in areas where off-road vehicles are permitted to travel.
- Respect private property. Get owner's permission before entering private property.
- Do not enter areas that are closed. Honor gates, barriers and signs that restrict travel.
- Stay on established roads. When conditions are wet, driving techniques should be changed or travel delayed to prevent damage to roads.

Additional information for off-road driving

► For owners in U.S. mainland, Hawaii and Puerto Rico:

To obtain additional information pertaining to driving your vehicle off-road, consult the following organizations:

- State and Local Parks and Recreation Departments
- State Motor Vehicle Bureau
- Recreational Vehicle Clubs
- U.S. Forest Service and Bureau of Land Management

 **WARNING****■ Off-road driving precautions**

Always observe the following precautions to minimize the risk of death, serious injury or damage to your vehicle:

- Drive carefully when off the road. Do not take unnecessary risks by driving in dangerous places.
- Do not grip the steering wheel spokes when driving off-road. A bad bump could jerk the wheel and injure your hands. Keep both hands and especially your thumbs on the outside of the rim.
- Always check your brakes for effectiveness immediately after driving in sand, mud, water or snow.
- After driving through tall grass, mud, rock, sand, rivers, etc., check that there is no grass, bush, paper, rags, stone, sand, etc. adhering or trapped on the underbody. Clear off any such matter from the underbody. If the vehicle is used with these materials trapped or adhering to the underbody, a breakdown or fire could occur.
- When driving off-road or in rugged terrain, do not drive at excessive speeds, jump, make sharp turns, strike objects, etc. This may cause loss of control or vehicle rollover causing death or serious injury. You are also risking expensive damage to your vehicle's suspension and chassis.

 NOTICE**■ To prevent the water damage**

Take all necessary safety measures to ensure that water damage to the engine or other components does not occur.

- Water entering the engine air intake will cause severe engine damage.
- Water entering the automatic transmission will cause deterioration in shift quality, locking up of your transmission accompanied by vibration, and ultimately damage.
- Water can wash the grease from wheel bearings, causing rusting and premature failure, and may also enter the differentials, transmission and transfer case, reducing the gear oil's lubricating qualities.

■ When you drive through water

If driving through water, such as when crossing shallow streams, first check the depth of the water and the bottom of the riverbed for firmness. Drive slowly and avoid deep water.

■ Inspection after off-road driving

- Sand and mud that has accumulated in brake drums and around brake discs may affect braking efficiency and may damage brake system components.
- Always perform a maintenance inspection after each day of off-road driving that has taken you through rough terrain, sand, mud, or water. For scheduled maintenance information, refer to the "Scheduled Maintenance Guide" or "Owner's Manual Supplement".

Winter driving tips

Carry out the necessary preparations and inspections before driving the vehicle in winter. Always drive the vehicle in a manner appropriate to the prevailing weather conditions.

Pre-winter preparations

- Use fluids that are appropriate to the prevailing outside temperatures.
 - Engine oil
 - Engine coolant
 - Washer fluid
- Have a service technician inspect the condition of the battery.
- Have the vehicle fitted with four snow tires or purchase a set of tire chains for the rear tires.

Ensure that all tires are the same size and brand, and that chains match the size of the tires.

Before driving the vehicle

Perform the following according to the driving conditions:

- Do not try to forcibly open a window or move a wiper that is frozen. Pour warm water over the frozen area to melt the ice. Wipe away the water immediately to prevent it from freezing.
- To ensure proper operation of the climate control system fan, remove any snow that has accumulated on the air inlet vents in front of the windshield.
- Check for and remove any excess ice or snow that may have accumulated on the exterior lights, vehicle's roof, chassis, around the tires or on the brakes.
- Remove any snow or mud from the bottom of your shoes before getting in the vehicle.

When driving the vehicle

Accelerate the vehicle slowly, keep a safe distance between you and the vehicle ahead, and drive at a reduced speed suitable to road conditions.

When parking the vehicle

Park the vehicle and move the shift lever to P without setting the parking brake. The parking brake may freeze up, preventing it from being released. If necessary, block the wheels to prevent inadvertent sliding or creeping.

Selecting tire chains

Use the correct tire chain size when mounting the snow chains. Chain size is regulated for each tire size.

- ① Side chain
(0.20 in. [5 mm] in diameter)
- ② Cross chain
(0.25 in. [6.3 mm] in diameter)

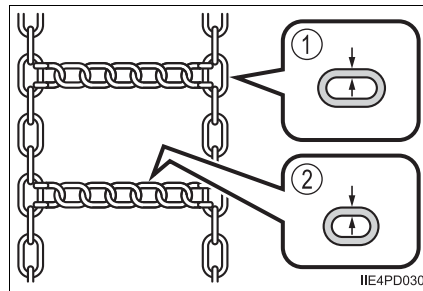

Regulations on the use of tire chains

Regulations regarding the use of tire chains vary depending on location and type of road. Always check local regulations before installing chains.

■ Tire chain installation

Observe the following precautions when installing and removing chains:

- Install and remove tire chains in a safe location.
- Install tire chains on the rear tires. Do not install tire chains on the front tires.
- Install tire chains on rear tires as tightly as possible. Retighten chains after driving 1/4 - 1/2 mile (0.5 - 1.0 km).
- Install tire chains following the instructions provided with the tire chains.

 **WARNING****■ Driving with snow tires**

Observe the following precautions to reduce the risk of accidents. Failure to do so may result in a loss of vehicle control and cause death or serious injury.

- Use tires of the specified size.
- Maintain the recommended level of air pressure.
- Do not drive in excess of 75 mph (120 km/h), regardless of the type of snow tires being used.
- Use snow tires on all, not just some wheels.

■ Driving with tire chains

Observe the following precautions to reduce the risk of accidents. Failing to do so may result in the vehicle being unable to be driven safely, and may cause death or serious injury.

- Do not drive in excess of the speed limit specified for the tire chains being used, or 30 mph (50 km/h), whichever is lower.
- Avoid driving on bumpy road surfaces or over potholes.
- Avoid sudden acceleration, abrupt steering, sudden braking and shifting operations that cause sudden engine braking.
- Slow down sufficiently before entering a curve to ensure that vehicle control is maintained.

 **NOTICE****■ Repairing or replacing snow tires**

Request repairs or replacement of snow tires from Toyota dealers or legitimate tire retailers.

This is because the removal and attachment of snow tires affects the operation of the tire pressure warning valves and transmitters.

■ Fitting tire chains

The tire pressure warning valves and transmitters may not function correctly when tire chains are fitted.

Interior features

5

5-1. Using the air conditioning system and defogger

- Front automatic air conditioning system 374
- Rear air conditioning system..... 385
- Heated steering wheel/seat heaters/seat ventilators... 389

5-2. Using the interior lights

- Interior lights list 393
 - Interior lights 394
 - Personal lights 395

5-3. Using the storage features

- List of storage features 396
 - Glove box..... 397
 - Console box..... 398
 - Overhead console..... 399
 - Cup holders 400
 - Bottle holders..... 402
 - Card holders 403
 - Auxiliary boxes..... 403
- Luggage compartment features 404

5-4. Using the other interior features

- Other interior features 406
 - Cool box..... 406
 - Sun visors 408
 - Vanity mirror 408
 - Clock..... 409
 - Outside temperature display..... 409
 - Power outlets 410
 - Wireless charger..... 412
 - Armrest 420
 - Coat hooks..... 420
 - Assist grips 421
- Garage door opener..... 422
- Safety Connect 427

Front automatic air conditioning system

Air outlets and fan speed are automatically adjusted according to the temperature setting.

Press  to display the air conditioning control screen.

Control panel

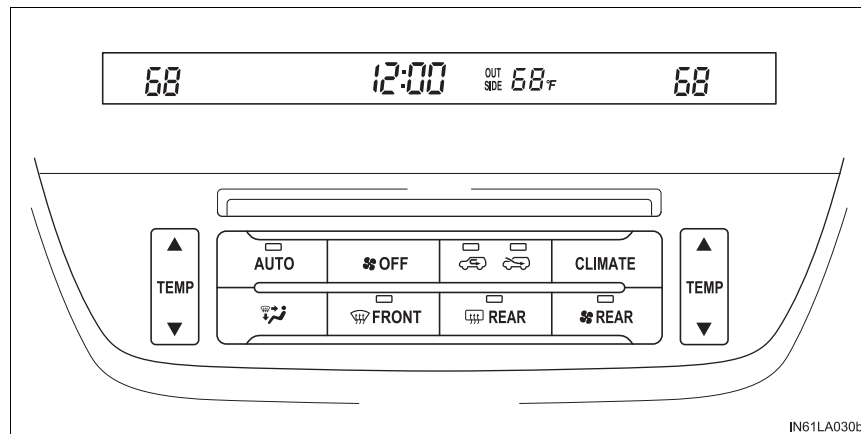

■ Adjusting the temperature setting

Press ▲ to increase the temperature and ▼ to decrease the temperature.

■ Changing the air flow mode

Press  .

The air flow mode switches each time the button is pressed.

- ① Air flows to the upper body
- ② Air flows to the upper body and feet
- ③ Air flows to the feet
- ④ Air flows to the feet and the windshield defogger operates

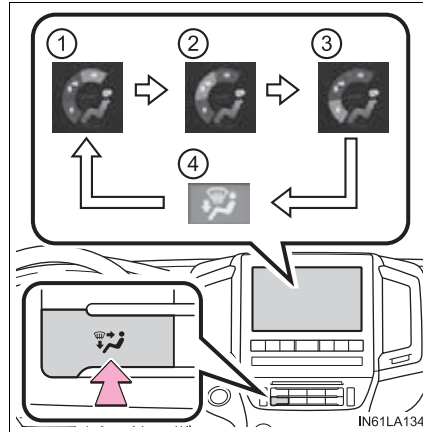

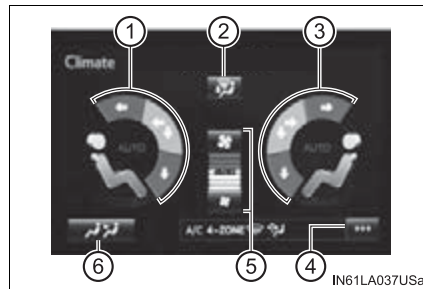

Control screen

- ① Select the air flow mode* (left-hand side)
- ② Air flows to the feet and the windshield defogger operates
- ③ Select the air flow mode* (right-hand side)
- ④ Display the option control screen (→P. 376)
- ⑤ Adjust the fan speed setting
- ⑥ Display the rear air conditioning control screen (→P. 378)



To adjust or select settings, touch the screen button.

- *:  — Air flows to the upper body
-  — Air flows to the upper body and feet
-  — Air flows to the feet

Option control screen

- ① Select to set cooling and dehumidification function on/off
- ② Adjust the temperature for driver, front passenger and rear seats separately (Individual mode) (→P. 377)
- ③ Prevent ice from building up on the windshield and wiper blades (if equipped) (→P. 380)
- ④ Remove pollen from the air (Micro dust and pollen filter) (→P. 380)

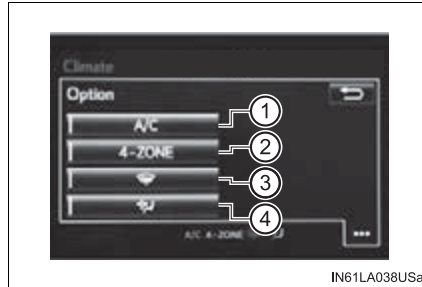

Air conditioning controls

■ Using the automatic mode

- 1 Press  .
- 2 Adjust the temperature setting.

To stop the operation, press  .

■ Automatic mode indicator

If the fan speed setting or air flow modes are operated, the automatic mode indicator goes off. However, automatic mode for functions other than that operated is maintained.

Adjusting the temperature for driver and passenger seats separately (Individual mode)

To turn on the individual mode, perform any of the following procedures:

- Press “4-ZONE” on the option control screen.
- Adjust the passenger’s side temperature setting.
- Change the rear air conditioning setting

The indicator comes on when the individual mode is on.

To return to the simultaneous mode, press “4-ZONE”.

In the simultaneous mode, only ▲ or ▼ on the driver’s side can be used to adjust the temperature for all seats.

Changing the rear seat settings

Press  on the control screen to display the rear air conditioning control screen.

- ① Adjust the temperature setting (left-hand rear seat)
- ② Adjust the fan speed setting
- ③ Adjust the temperature setting (right-hand rear seat)
- ④ Select to set automatic mode
- ⑤ Turn the fan off

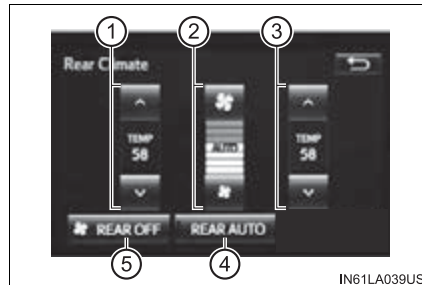

■ Using the automatic mode

- 1 Press "REAR AUTO".

The air conditioning system will operate, and air outlets and speed will be set automatically.

- 2 Press "∧" to increase the temperature and "∨" to decrease the temperature.



Air outlets for the right-hand and left-hand may be set separately depending on the temperature setting.

■ Adjusting the temperature setting

Press "∧" (increase) "∨" or (decrease).

Operating the switch will enter the individual mode. (→P. 377)

■ Adjusting the fan speed setting

Press  (increase) or  (decrease).

The fan speed is shown on the display. (7 levels)

Press "REAR OFF" to turn the fan off.



■ Turning the rear air conditioning system off

Press "REAR OFF".

Other functions

■ Switching between outside air and recirculated air modes

Press  .

The mode switches between  (recirculated air mode) and  (outside air mode) modes each time the button is pressed.

■ Defogging the windshield

Defoggers are used to defog the windshield and front side windows.

Press  .

Set the outside/recirculated air mode button to outside air mode if the recirculated air mode is used. (It may switch automatically.)

To defog the windshield and the side windows early, turn the air flow and temperature up.

To return to the previous mode, press  again when the windshield is defogged.

■ **Defogging the rear window and outside rear view mirrors**

Defoggers are used to defog the rear window, and to remove rain-drops, dew and frost from the outside rear view mirrors.

Press  .

Press the switch again to turn the defogger off.

■ **Micro dust and pollen filter**

1 Press  on the control screen.

2 Press  .

Outside air mode switches to recirculated air mode. Pollen is removed from the air and the air flows to the upper part of the body.

Usually the system will turn off automatically approximately 1 to 3 minutes.

To stop the operation, press  again.

■ **Windshield wiper de-icer (if equipped)**

This feature is used to prevent ice from building up on the windshield and wiper blades.

1 Press  on the control screen.

2 Press  .

Press  again to turn the de-icer off.

Air outlets

■ Location of air outlets

The air outlets and air volume changes according to the selected air flow mode.

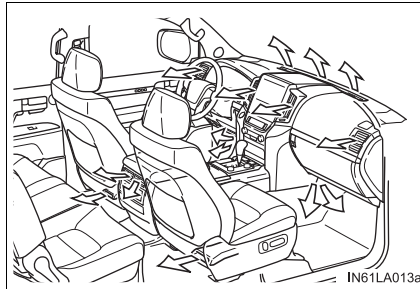

■ Adjusting the position of and opening and closing the air outlets

► Front outlets

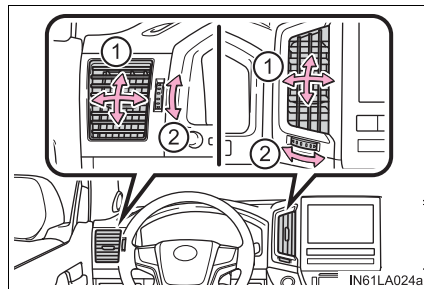

► Rear outlets

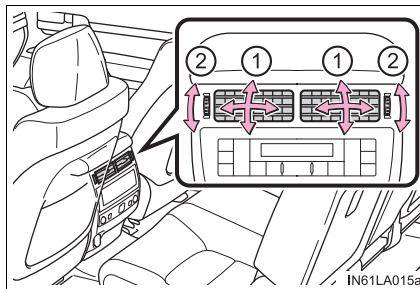

- ① Direct air flow to the left or right, up or down.
- ② Turn the knob to open or close the vent.

■ Using automatic mode

Fan speed is adjusted automatically according to the temperature setting and the ambient conditions.

Therefore, the fan may stop for a while until warm or cool air is ready to flow

immediately after  is pressed.

■ Fogging up of the windows

- The windows will easily fog up when the humidity in the vehicle is high. Turning "A/C" on will dehumidify the air from the outlets and defog the windshield effectively.
- If you turn "A/C" off, the windows may fog up more easily.
- The windows may fog up if the recirculated air mode is used.

■ Outside/recirculated air mode

- When driving on dusty roads such as tunnels or in heavy traffic, set the outside/recirculated air mode button to the recirculated air mode. This is effective in preventing outside air from entering the vehicle interior. During cooling operation, setting the recirculated air mode will also cool the vehicle interior effectively.
- Outside/recirculated air mode may automatically switch depending on the temperature setting or the inside temperature.

■ When outside air temperature is low

The dehumidification function may not operate even when "A/C" is pressed.

■ When the outside temperature exceeds 75°F (24°C) and the air conditioning system is on

- In order to reduce the air conditioning power consumption, the air conditioning system may switch to recirculated air mode automatically. This may also reduce fuel consumption.
- Recirculated air mode is selected as a default mode when the engine switch is turned to IGNITION ON mode.
- It is possible to switch to outside air mode at any time by pressing



■ Micro dust and pollen filter

- In order to prevent the windows from fogging up when the outside air is cold, the following may occur.
 - Outside air mode does not switch to recirculated air mode.
 - The dehumidification function operates.
 - The operation cancels after approximately 1 minute.
- In rainy weather, the windows may fog up. Press  .
- In extremely humid weather, the windows may fog up.
- The pollens are filtered out even if the micro dust and pollen filter is turned off.

■ Ventilation and air conditioning odors

- To let fresh air in, set the air conditioning system to the outside air mode.
- During use, various odors from inside and outside the vehicle may enter into and accumulate in the air conditioning system. This may then cause odor to be emitted from the vents.
- To reduce potential odors from occurring:
 - It is recommended that the air conditioning system be set to outside air mode prior to turning the vehicle off.
 - The start timing of the blower may be delayed for a short period of time immediately after the air conditioning system is started in automatic mode.

■ The rear window defogger and windshield wiper de-icer (if equipped) can be operated when

The engine switch is in IGNITION ON mode.

■ When the windshield wiper de-icer (if equipped) is on

The windshield wiper de-icer will automatically turn off after approximately 15 minutes.

■ Using the voice command system

Air conditioning system can be operated using voice commands. For details, refer to the "NAVIGATION SYSTEM OWNER'S MANUAL".

■ Air conditioning filter

→P. 477

■ Customization

Settings (e.g. A/C automatic mode switch operation) can be changed.
(Customizable features: →P. 574)

⚠ WARNING**■ To prevent the windshield from fogging up**

- Do not use  during cool air operation in extremely humid weather. The difference between the temperature of the outside air and that of the windshield can cause the outer surface of the windshield to fog up, blocking your vision.
- Do not place anything on the instrument panel which may cover the air outlets. Otherwise, air flow may be obstructed, preventing the windshield defoggers from defogging.

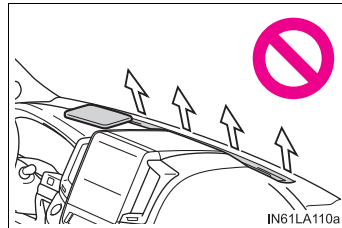
**■ To prevent burns**

- Do not touch the rear view mirror surfaces when the outside rear view mirror defoggers are on.
- Do not touch the glass at lower part of the windshield or to the side of the front pillars when the windshield wiper de-icer is on. (vehicles with windshield wiper de-icer)

⚠ NOTICE**■ To prevent battery discharge**

Do not leave the air conditioning system on longer than necessary when the engine is not running.

Rear air conditioning system

Air outlets and fan speed are automatically adjusted according to the temperature setting.

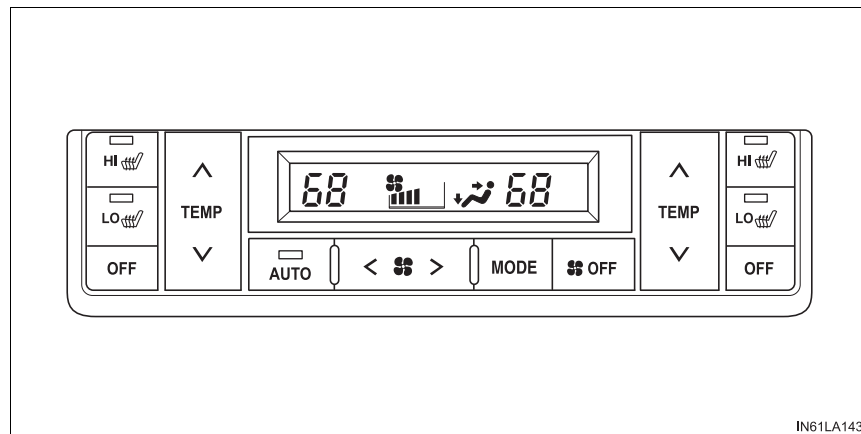

■ Adjusting the temperature setting

Press “^” to increase the temperature and “v” to decrease the tem-

perature on .

The temperature for the right-hand and left-hand seats can be set separately.

■ Adjusting the fan speed setting

Press “>” (increase) or “<” (decrease) on .

The fan speed is shown on the display. (7 levels)

Press  to turn the fan off.

■ **Changing the air flow mode**

Press **MODE**.

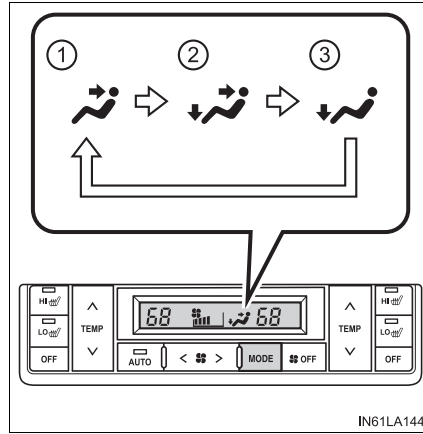

The air flow mode switches each time the button is pressed.

- ① Air flows to the upper body
- ② Air flows to the upper body and feet
- ③ Air flows to the feet



Air conditioning controls

■ Using the automatic mode

- 1 Press .
- 2 Adjust the temperature setting.
- 3 To stop the operation, press .

■ If the system is operated manually in automatic mode

If the fan speed setting or air flow modes are operated, the automatic mode indicator goes off. However, automatic mode for functions other than that operated is maintained.

Air outlets

■ Location of air outlets

The air outlets and air volume changes according to the selected air flow mode.

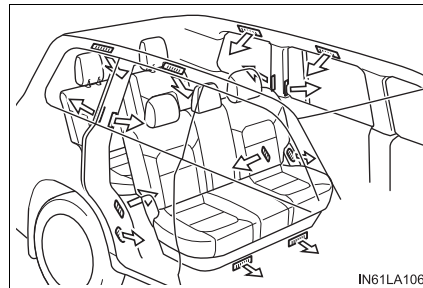

■ Adjusting the position of and opening and closing the air outlets

- ① Direct air flow to the left or right, up or down.
- ② Turn the knob fully to the back of the vehicle to close the vent.

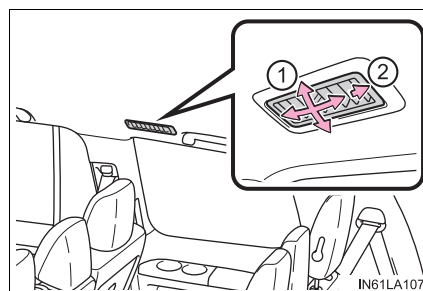



NOTICE

■ **To prevent battery discharge**

Do not leave the air conditioning system on longer than necessary when the engine is not running.

Heated steering wheel*/seat heaters/seat ventilators

Heated steering wheel and seat heaters heat the side grips of the steering wheel and seats. Seat ventilators maintain good airflow by blowing air from the seats.

WARNING

- Care should be taken to prevent injury if anyone in the following categories comes in contact with the steering wheel and seats when the heater is on:
 - Babies, small children, the elderly, the sick and the physically challenged
 - Persons with sensitive skin
 - Persons who are fatigued
 - Persons who have taken alcohol or drugs that induce sleep (sleeping drugs, cold remedies, etc.)
- Observe the following precautions to prevent the minor burns or overheating:
 - Do not cover the seat with a blanket or cushion when using the seat heater.
 - Do not use seat heater more than necessary.

NOTICE

- Do not put heavy objects that have an uneven surface on the seat and do not stick sharp objects (needles, nails, etc.) into the seat.
- To prevent battery discharge, do not use the functions when the engine is not running.

Heated steering wheel (if equipped)

Turns the heated steering wheel on/off

The indicator light comes on when the heated steering wheel is operating.

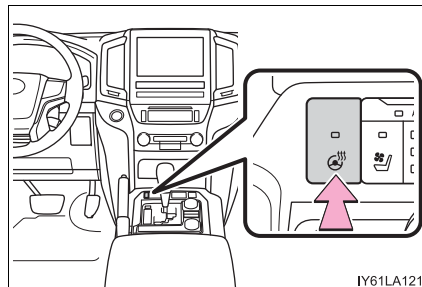

*: If equipped

5
Interior features

- The heated steering wheel can be used when the engine switch is in IGNITION ON mode.
- The heated steering wheel will automatically turn off after about 30 minutes.
- If the indicator light flashes, press the switch to turn the heated steering wheel off and then press the switch again. If the indicator light still flashes, a malfunction may be occurring. Turn the heated steering wheel off and have the vehicle inspected by your Toyota dealer.

Front seat heaters and ventilators

- ① Seat heater switches
The indicator light (yellow) on the switch comes on when the seat heater is operating.
- ② Seat ventilator switches
The indicator light (green) on the switch comes on when the seat ventilator is operating.
- ③ Level indicator lights
The seat heater temperature level or the seat ventilator fan speed level (for front seats only) is displayed.
- ④ "AUTO" indicator lights

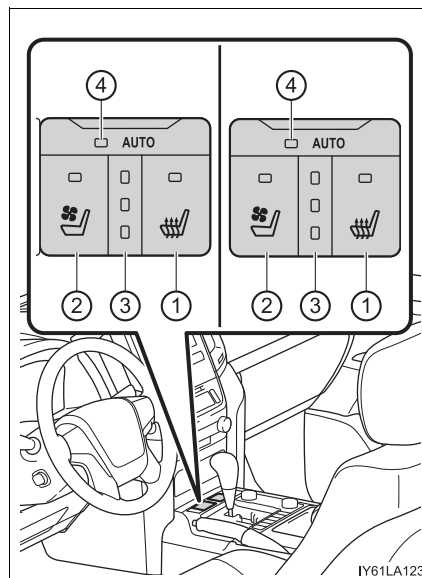

■ Modes and indicators

The mode can be changed by pressing the switch.

Mode	"AUTO" indicator light	Level indicator lights
Off	Off	Off
Automatic*	On	3 to 1, or off
Hi	Off	3
Mid	Off	2
Lo	Off	1

*: When automatic mode is selected, the level automatically changes depending on the air conditioning settings.

■ The seat heaters and ventilators can be used when

The engine switch is in IGNITION ON mode.

■ Replacing the air filters

Filters are installed in the seat ventilators. For replacement of the filters, contact your Toyota dealer.

■ Customization

The automatic mode settings for the seat heaters and ventilators can be changed. (→P. 574)

Second outboard seat heaters (if equipped)

- ① For left-hand second seat
- ② For right-hand second seat
- ③ High heating temperature
- ④ Low heating temperature

To turn on the seat heater, press "HI" or "LO".

- ⑤ Off

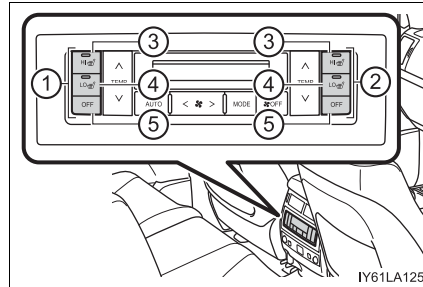
**■ The seat heaters can be used when**

The engine switch is in IGNITION ON mode.

Interior lights list

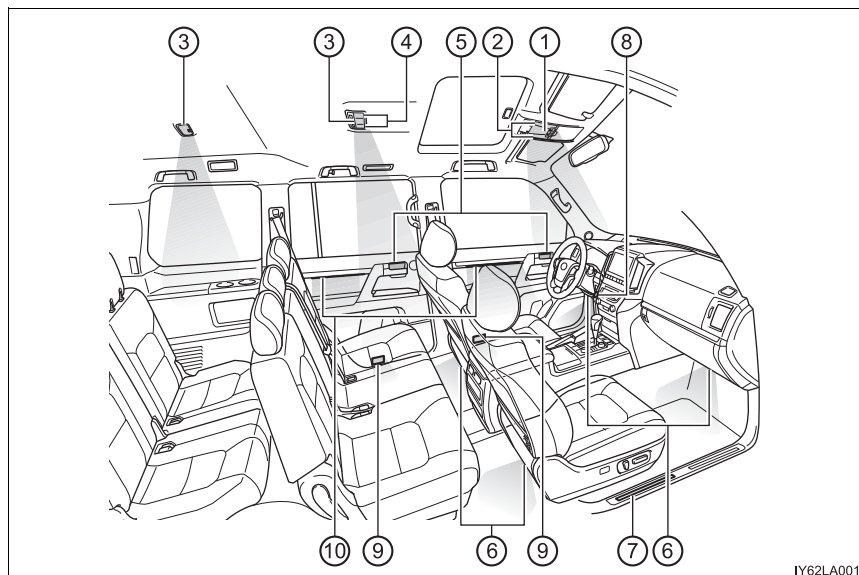

- | | |
|-----------------------------------|------------------------|
| ① Front interior lights (→P. 394) | ⑥ Footwell lights |
| ② Front personal lights (→P. 395) | ⑦ Scuff lights |
| ③ Rear interior lights (→P. 394) | ⑧ Engine switch light |
| ④ Rear personal lights (→P. 395) | ⑨ Door courtesy lights |
| ⑤ Inside door handle lights | ⑩ Ambient lights |

Interior lights

► Front

- ① Door position on/off
- ② Turns the light on/off

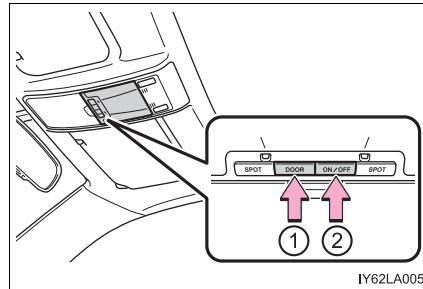

► Rear

On/door position on

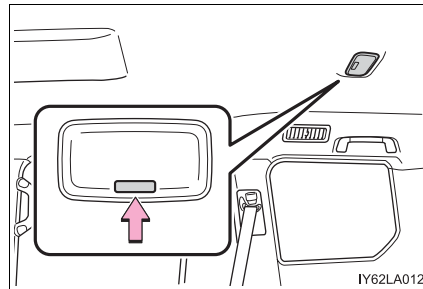

Personal lights

► Front

Turns the light on/off

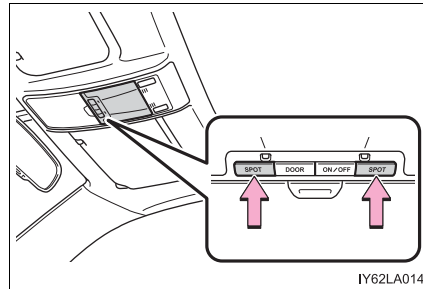

► Rear

Turns the light on/off

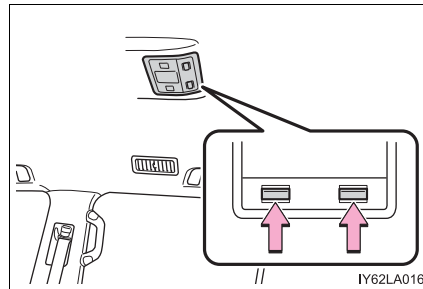

■ **Illuminated entry system**

The lights automatically turn on/off according to engine switch mode, the presence of the electronic key, whether the doors are locked/unlocked, and whether the doors are open/closed.

■ **To prevent battery discharge**

If the interior lights remain on when the engine switch is turned off, the lights will go off automatically after 20 minutes:

■ **Customization**

Settings (e.g. adjust the time elapsed before the interior lights automatically turn off) can be changed. (Customizable features: →P. 574)

 **NOTICE**

To prevent battery discharge, do not leave the lights on longer than necessary when the engine is not running.

List of storage features

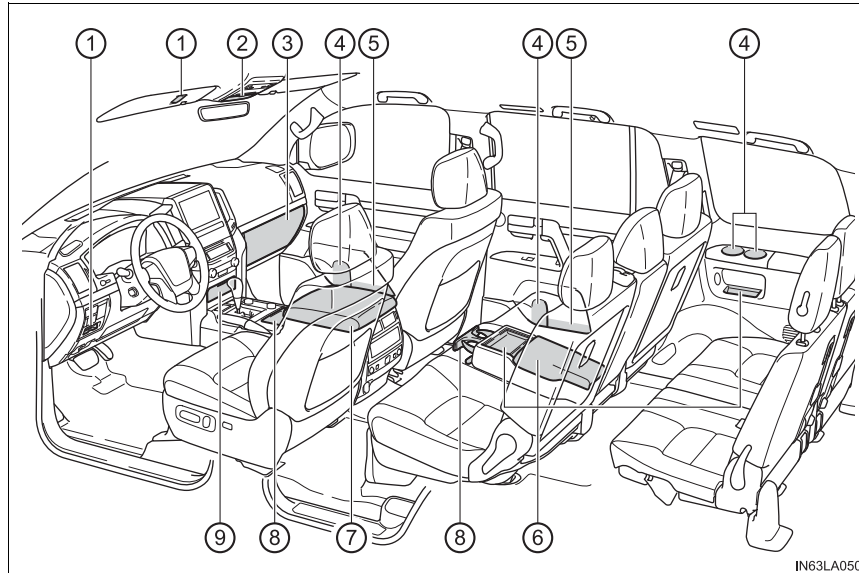

- | | |
|------------------------------|--------------------------------|
| ① Card holders (→P. 403) | ⑦ Console box (→P. 398) |
| ② Overhead console (→P. 399) | Cool box (if equipped) |
| ③ Glove box (→P. 397) | (→P. 406) |
| ④ Bottle holders (→P. 402) | ⑧ Cup holders (→P. 400) |
| ⑤ Door pockets | ⑨ Auxiliary box (if equipped) |
| ⑥ Auxiliary boxes (→P. 403) | (→P. 403) |
| | Wireless charger (if equipped) |
| | (→P. 412) |

WARNING

■ Items that should not be left in the storage spaces

Do not leave glasses, lighters or spray cans in the storage spaces, as this may cause the following when cabin temperature becomes high:

- Glasses may be deformed by heat or cracked if they come into contact with other stored items.
- Lighters or spray cans may explode. If they come into contact with other stored items, the lighter may catch fire or the spray can may release gas, causing a fire hazard.

Glove box

- ① Open (push button)
- ② Lock with the mechanical key
- ③ Unlock with the mechanical key

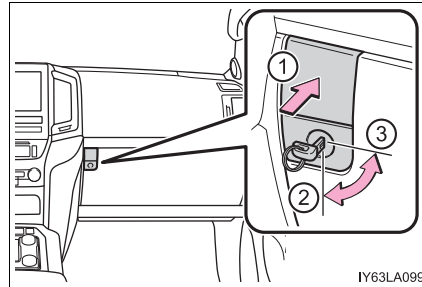
**Glove box light**

The glove box light turns on when the tail lights are on.

Removing the separate tray

Pull out the separate tray while releasing the clips.

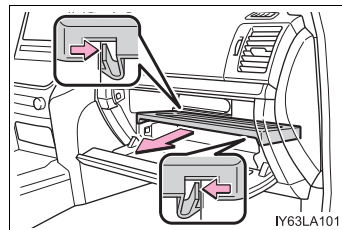
**⚠ WARNING**

Keep the glove box closed while driving.
Injuries may result in the event of sudden braking, sudden swerving or an accident.

Console box

Your vehicle is equipped with either a lower console box or cool box. For vehicles with the cool box, refer to page 406.

► Upper console box

Press the tab to open.

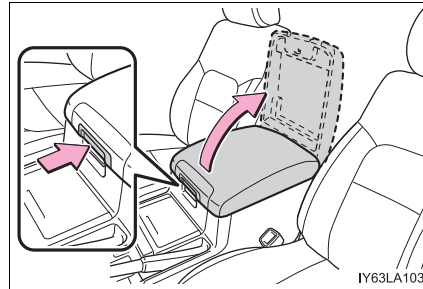

► Lower console box (if equipped)

1 Lift the lever to open.

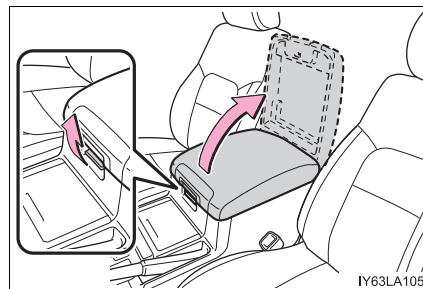

2 Remove the tray.

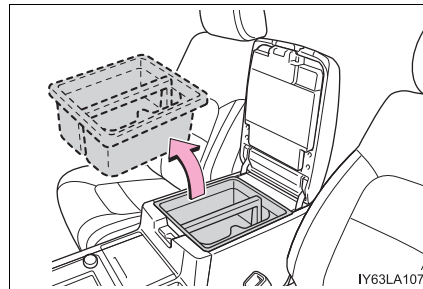

⚠ WARNING

Keep the console box closed while driving. Injuries may result in the event of sudden braking, sudden swerving or an accident.

Overhead console

Press the button.

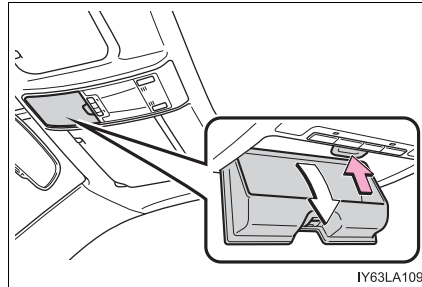
**⚠ WARNING****■ Items unsuitable for storing**

Do not store items heavier than 0.4 lb. (0.2 kg).
Doing so may cause the overhead console to open and the items inside may fall out, resulting in an accident.

■ While driving

Do not leave the overhead console open.
Items may fall out and cause injury.

Cup holders

► Front

Press down and release the lid.

You can adjust or remove the separator inside.

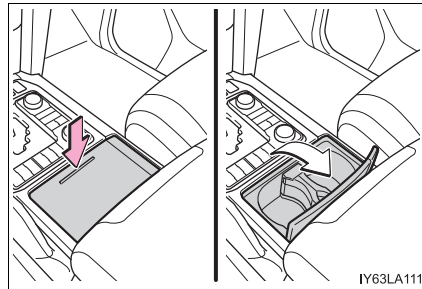

► Rear

- 1 Pull the armrest down. (→P. 420)
- 2 Press the button.

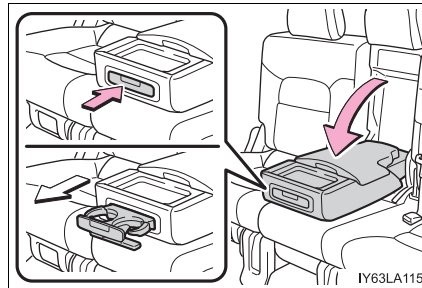

■ Removing the cup holder insert (front cup holders)

Pull up the insert.

Cup holder insert may be removed for cleaning.

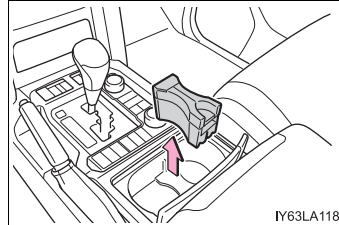
**⚠ WARNING****■ Items unsuitable for the cup holder**

Do not place anything other than cups or beverage cans in the cup holders. Even with the lid is closed, items must not be stored in the cup holders. Other items may be thrown out of the holders in the event of an accident or sudden braking, cause injury. If possible, cover hot drinks to prevent burns.

■ When not in use

Keep the cup holders closed.

Injuries may result in the event of sudden braking, sudden swerving or an accident.

⚠ NOTICE**■ To prevent damage to the cup holders (vehicles with a rear cup holder)**

Stow the cup holders before stowing the rear armrest.

Bottle holders

► Front seats

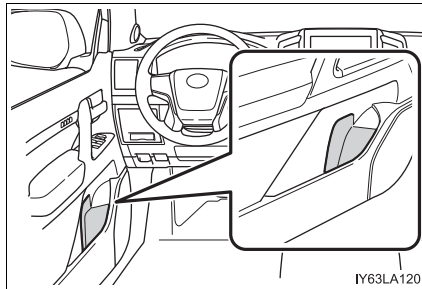

► Second seats

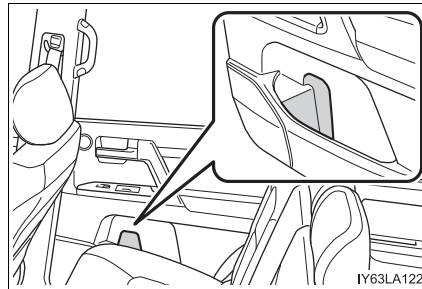

► Third seats

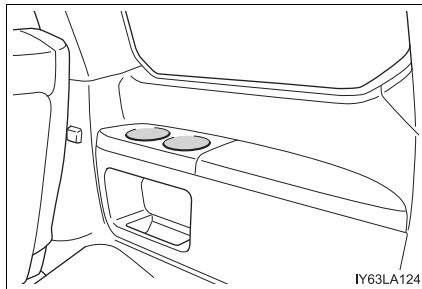

 NOTICE

■ **Items that should not be stowed in the bottle holders**

Put the cap on before stowing a bottle. Do not place open bottles in the bottle holders, or glasses and paper cups containing liquid. The contents may spill and glasses may break.

Card holders

► Sun visor

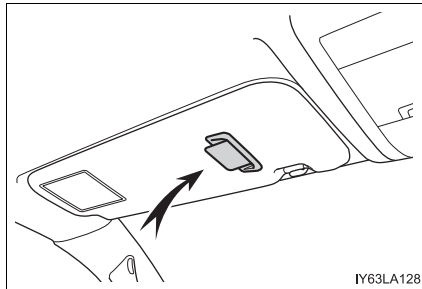

► Instrument panel

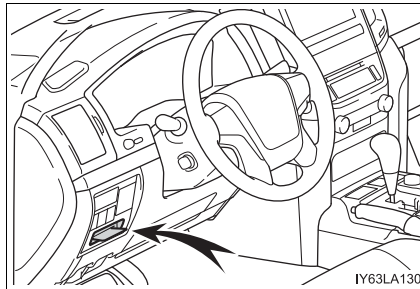

Auxiliary boxes

Your vehicle is equipped with either a front auxiliary box or wireless charger.

For vehicles with wireless charger, refer to page 412.

► Front (if equipped)

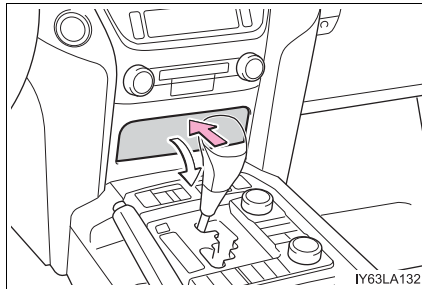

Press the lid to open.

► Rear (type A)

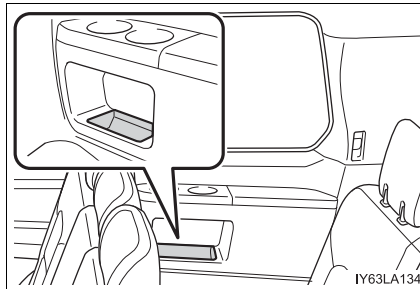

► Rear (type B)

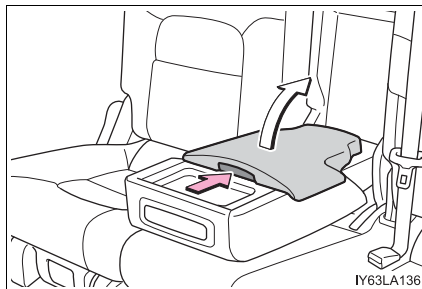

Press the button to open.

Luggage compartment features

Cargo hooks

Raise the hook to use.

The cargo hooks are provided for securing loose items.

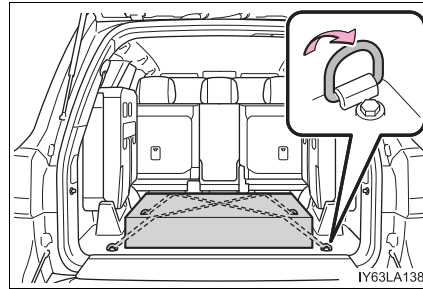

Cargo net hooks

To hang the cargo net, use the cargo net hooks and rear tie-down hooks.

The cargo net itself is not included as an original equipment.

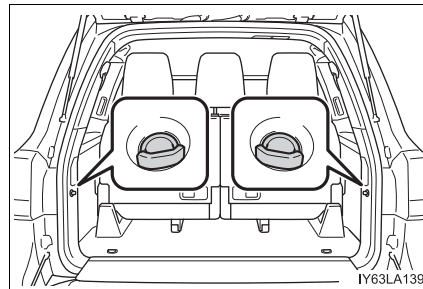

Warning reflector holder

Remove the cover. Hold the warning reflector with the bands.

The warning reflector itself is not included as an original equipment.

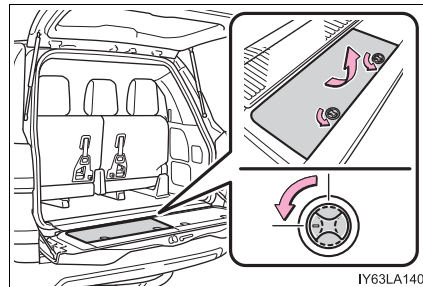

First-aid kit holder

Remove the cover. Hold the first-aid kit with a band.

The first-aid kit itself is not included as an original equipment.

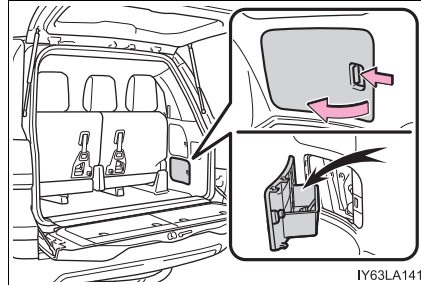
**⚠ WARNING**

- To avoid injury, always return the cargo hooks to their positions when not in use.
- Keep the auxiliary box closed. In the event of sudden braking or sudden swerving, an accident may occur due to an occupant being struck by an open auxiliary box or the items stored inside.

⚠ NOTICE

- **To prevent damage to the cargo net hooks**
Avoid hanging things other than a cargo net on it.

Other interior features

Cool box (if equipped)

While the engine is running, the cool box, which is cooled by the air conditioning, can be used.

- 1 Lift the lid while pulling up the lower lever to release the lock.

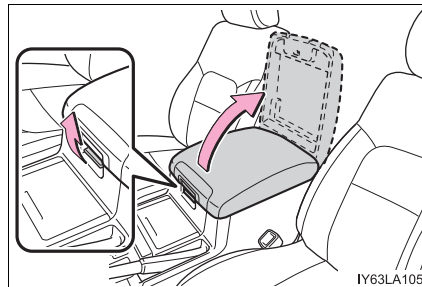

- 2 Turns the cool box on/off
When on, the indicator light comes on.
If the front air conditioning system is not in use, the front air conditioning system is automatically turned on when the cool box is turned on.

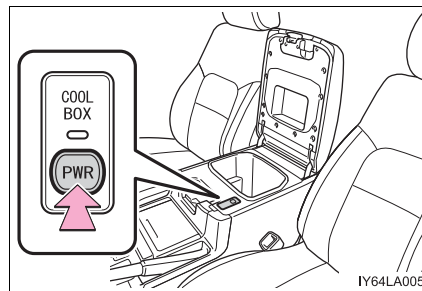

■ While the cool box is on

The front air conditioning system cannot be turned off.

■ When the outside temperature is 0°C (32°F) or below

The cool box may not operate.

 **WARNING**

Keep the cool box closed while driving.
Injuries may result in the event of sudden braking, sudden swerving or an accident.

 **NOTICE**

To prevent battery discharge, do not leave the cool box on longer than necessary when the engine is not running.

Sun visors

► Main sun visor

- ① To set the visor in the forward position, flip it down.
- ② To set the visor in the side position, flip down, unhook, and swing it to the side.
- ③ To use the side extender, place the visor in the side position, then slide it backward.

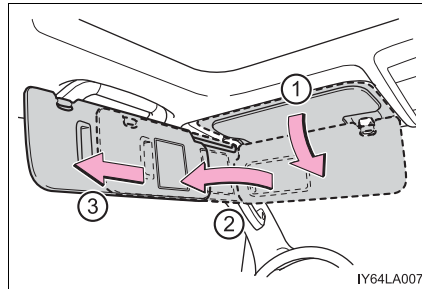

► Sub sun visor

Flip down with the main sun visor in position ② or ③.

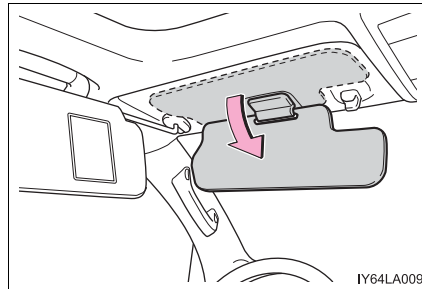

Vanity mirror

Slide the cover to open.

The light turns on when the cover is opened.

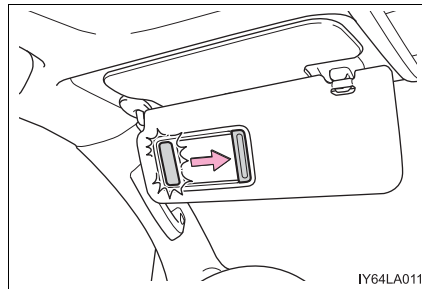

If the vanity lights remain on when the engine switch is turned off, the lights will go off automatically after 20 minutes.



NOTICE

To prevent battery discharge, do not leave the vanity lights on for extended periods when the engine is not running.

Clock

Refer to “NAVIGATION SYSTEM OWNER’S MANUAL” for adjustment.

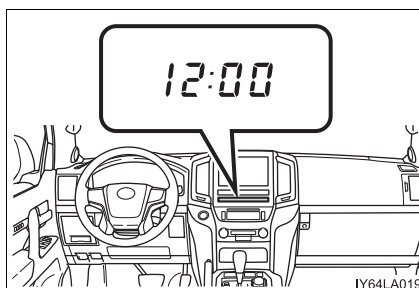

■ The clock is displayed when

The engine switch is in ACCESSORY or IGNITION ON mode.

Outside temperature display

The displayed temperature ranges from -22°F (-30°C) up to 122°F (50°C).

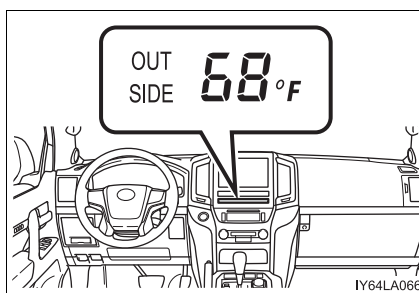

■ The outside temperature is displayed when

The engine switch is in IGNITION ON mode.

■ When --- is displayed

The system may be malfunctioning. Take your vehicle to your Toyota dealer.

■ Display

In the following situations, the correct outside temperature may not be displayed, or the display may take longer than normal to change.

- When stopped, or driving at low speeds (less than 12 mph [20 km/h])
- When the outside temperature has changed suddenly (at the entrance/exit of a garage, tunnel, etc.)

Power outlets

The power outlet can be used for the following components:

12 V DC: Accessories that run on less than 10 A

120 V AC: Accessories that use less than 100 W

■ Center of console

► Front (12 V DC)

Press the lid to open.

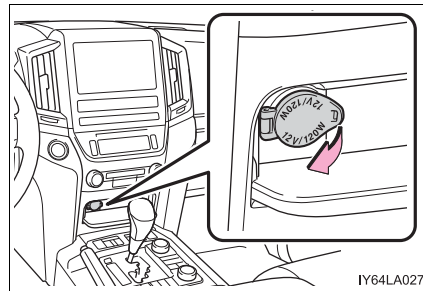
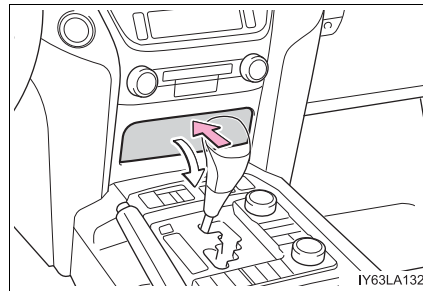

► Rear (12 V DC)

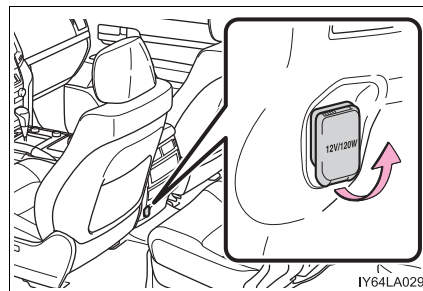

■ Luggage compartment (120 V AC)

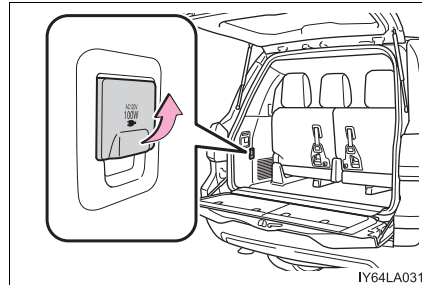

■ The power outlet can be used when

12 V DC: The engine switch is in ACCESSORY or IGNITION ON mode.

120 V AC: The engine switch is in IGNITION ON mode.

⚠ NOTICE

■ To avoid damaging the power outlets

Close the power outlet lid when not in use.

Foreign objects or liquids that enter the power outlet may cause a short circuit.

■ To prevent the fuse from being blown

12 V DC: Do not use an accessory that uses more than 12 V 10 A.

120 V AC: Do not use a 120 V AC appliance that requires more than 100 W.

If a 120 V AC appliance that consumes more than 100 W is used, the protection circuit will cut the power supply.

■ To prevent the battery from being discharged

Do not use the power outlet longer than necessary when the engine is not running.

■ Appliances that may not operate properly (120 V AC)

The following 120 V AC appliances may not operate even if their power consumption is under 100 W.

- Appliances with high initial peak wattage
- Measuring devices that process precise data
- Other appliances that require an extremely stable power supply

Wireless charger (if equipped)

A portable device can be charged by just placing Qi standard wireless charge compatible portable devices according to the Wireless Power Consortium, such as smart phones and mobile batteries, etc., on the charge area.

This function cannot be used with portable devices that are larger than the charging area. Also, depending on the portable device, it may not operate as normal. Please read the operation manual for portable devices to be used.

■ The “Qi” symbol

The “Qi” symbol is a trademark of the Wireless Power Consortium.

**■ Name for all parts**

- ① Power supply switch
- ② Operation indicator light
- ③ Charge area

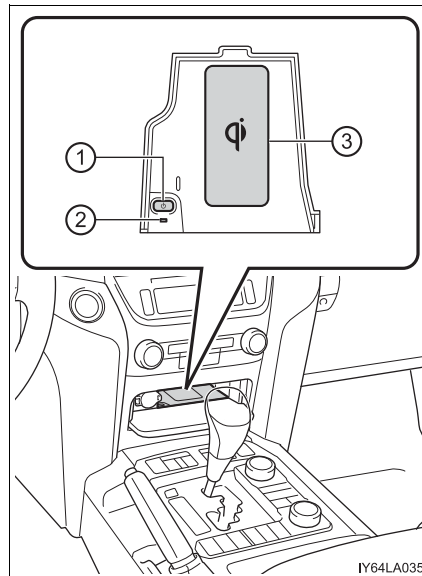

■ Using the wireless charger

- 1 Press the lid to open.

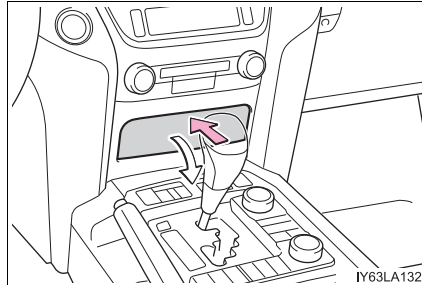

- 2 Press the power supply switch of the wireless charger.

Switches on and off with each press of the power supply switch.

When turned on, the operation indicator light (green) comes on.

Even with the engine off, the on/off state of the power supply switch is memorized.

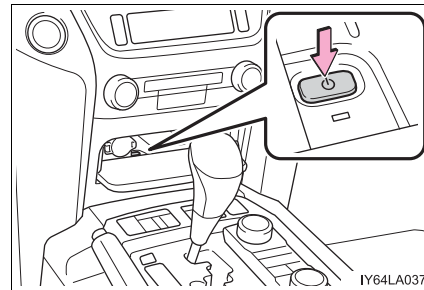

- 3 Place the charging side of the portable device down.

When charging, the operation indicator light (orange) comes on.

If charging is not occurring, try placing the portable device as close to the center of the charging area as possible.

When charging is complete, the operation indicator light (green) comes on.

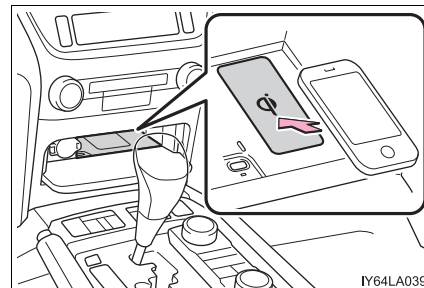

● Recharging function

- When charging is complete and after a fixed time in the charge suspension state, charging restarts.
- When the portable device is moved, charging is stopped for a moment and then it restarts.

■ **Lighting conditions of operation indicator light**

Operation indicator light	Conditions
Turning off	When the Wireless charger power supply is off
Green (comes on)	On Standby (charging possible state)
	When charging is complete*
Orange (comes on)	When placing the portable device on the charging area (detecting the portable device)
	Charging

*: Depending on the portable device, there are cases where the operation indicator light will continue being lit up orange even after the charging is complete.

● **When the operation indicator light flashes**

When an error occurs, the operation indicator light flashes an orange color. Handle the error based on the following table.

Operation indicator light	Suspected causes	Handling method
Flashing repeatedly once every second (Orange)	Vehicle to charger communication failure.	Contact your Toyota dealer.
Repeatedly flashes 3 times continuously (Orange)	A foreign substance is between the portable device and charge area.	Remove the foreign substance from between portable device and the charge area.
	The portable device is out of sync due to the device being shifted from its position.	Place the portable device near the center of the charge area.
Repeatedly flashes 4 times continuously (Orange)	Temperature rising within the wireless charger.	Stop charging at once and start charging again after for a while.

■ The wireless charger can be operated when

The engine switch is in ACCESSORY or IGNITION ON mode.

■ Usable portable devices

Qi standard wireless charge standard can be used on compatible devices. However, not all Qi standard devices and compatibility are guaranteed.

Starting with mobile phones and smart phones, it is aimed for low power electrically supplied portable devices of no more than 5W.

■ When covers and accessories are attached to portable devices

Do not charge in situations where cover and accessories not able to handle Qi are attached to the portable device. Depending on the type of cover and accessory, it may not be possible to charge. When charging is not performed even with the portable device placed on the charge area, remove the cover and accessories.

■ While charging, noise enters the AM radio

Turn off the wireless charger and confirm that the noise has decreased. If the noise decreases, continuously pushing the power supply switch of the wireless charger for 2 seconds, the frequency of the charger can be changed and the noise can be reduced.

Also, on that occasion, the operation indicator light will flash orange 2 times.

■ Important points of the wireless charger

- If the electronic key cannot be detected within the vehicle interior, charging cannot be done. When the door is opened and closed, charging may be temporarily suspended.
- When charging, the wireless charging device and portable device will get warmer, however this is not a malfunction.
When a portable device gets warm while charging, charging may stop due to the protection function on the portable device side. In this case, when the temperature of the portable device drops significantly, charge again.

■ Operation sounds

When the power supply is turned on, while searching for the portable device a sound will be produced, however this is not a malfunction.

■ **Certification for the wireless charger**

FCC Note: This equipment has been tested and found to comply with Part 18 of the FCC Rules. These limits are designed to provide reasonable protection against harmful interference in a residential installation.

FCC Caution: Any changes or modifications not expressly approved by the party responsible for compliance could void the user's authority to operate this equipment.

<u>Declaration of Conformity</u>	
Trade Name:	Panasonic
Model Numbers:	CA-QS05H1AJ, CA-QS05H2AJ
Responsible Party:	Panasonic Corporation of North America Two Riverfront Plaza, Newark, NJ 07102-5490
Support Contact:	http://www.panasonic.com/contactinfo
This device complies with Part 18 of the FCC Rules. Operation is subject to the following two conditions: (1) This device may not cause harmful interference, and (2) this device must accept any interference received, including interference that may cause undesired operation.	

Panasonic

PRODUCT SAFETY AND COMPLIANCE DEPARTMENT, PANASONIC CORPORATION OF NORTH AMERICA, TWO RIVERFRONT PLAZA, 9TH FLOOR, NEWARK, NJ 07102-5490

FCC Declaration of Conformity

Product Name	Panasonic In-Vehicle Wireless Charger
Model Numbers	CA-QS05H1AJ, CA-QS05H2AJ
FCC Rule Parts	47 CFR, FCC Part 18 for ISM Equipment FCC's KDB 0680106 D01 RF Exposure Wireless Charging Apps v02
Product Description	All In-Vehicle Wireless Chargers contain same primary coil, type YEFXU00276 with rated power transfer operating frequency of 105-140 kHz, charge operating voltage 100V peak-to-peak and output rating DC 10.5-16.0V, 1A and 13.2 watts. This product receives its operating power from host vehicle it is installed into and enables wireless battery charging of any mobile device with Qi mark placed on charging pad.
Special Conditions	Must be provided with product label with FCC logo. Must be provided with User Manual with responsible party's name, address and telephone number or website address. Must be installed and used exclusively within transportation vehicle.
FCC Test Reports	UL Japan EMI Test Report 10120384-R1, dated December 24, 2013. This reported CA-QS04H0AJ was tested, which represents CA-QS05H1AJ and CA-QS05H2AJ. This test report demonstrated compliance with FCC Part 18, Subpart C and Section 18.305(b) and was tested in accordance with test procedure MP-5.
RF Exposure Evaluation Test Reports	UL Japan MPE Test Report 101971575-E-R1, dated March 19, 2014. This test report reported representative Model CA-QS04H0AJ was tested, which also represented Models CA-QS05H1AJ and CA-QS05H2AJ. <ul style="list-style-type: none"> Wireless Charging Pad complies with KDB 0680106 D01 RF Exposure Wireless Charging Apps v02. Test results for magnetic field strength is 0.391 (A/m) at 118 kHz charging mode and 30% of MPE limits for frequency range 110-200 kHz is 0.489 (A/m). Test results for electro-magnetic field strength is 147.40 (V/m) at 118 kHz charging mode and 30% of MPE limits for 110-200 kHz is 184.2 (V/m). MPE limits comply with limits in Table 1(B), refer to test report section 5.
Responsible Applicant	Panasonic Corporation Automotive & Industrial Systems Company 4261, Ikonobe-cho, Tsuzuki-ku, Yokohama-shi, 224-8520, Japan
Responsible Sales Company	Panasonic Consumer Electronics Company Division of Panasonic Corporation of North America Two Riverfront Plaza, Newark, NJ 07102-5490 Support Contact: http://www.panasonic.com/contactinfo

5 Interior features



Issued by: *Richard Mullen*
 PSCD Issue Date: Richard Mullen
 Updated Date: March 25, 2014
 Applicant Ref No.: January 13, 2015
 PSCD Ref No.: PAS-14-F004A
 DoC 2014-008A

 **WARNING**

■ **Caution while driving**

When charging a portable device, for safety reasons, the driver should not operate the main part of the portable device while driving.

■ **Caution regarding interference with electronic devices**

People with implantable cardiac pacemakers, cardiac resynchronization therapy-pacemakers or implantable cardioverter defibrillators, as well as any other electrical medical device, should consult their physician about the usage of the wireless charger. The operations of the wireless charger may have an affect on medical devices.

■ **To prevent damage or burns**

Observe the following precautions.

Failure to do so may result in a possibility of equipment failure and damage, catch fire, burns due to overheat.

- Do not insert any metallic objects between the charging area and the portable device while charging
- Do not attach stickers, metallic objects, etc., to the charger area or portable device
- Do not cover with cloth, etc., and charge
- Do not charge portable devices other than designated
- Do not attempt to dismantle for disassembly or modifications
- Do not hit or apply a strong force

 **WARNING**
■ Conditions in which the function may not operate correctly

In the following conditions, it may not operate correctly

- The portable device is fully charged
- There is foreign matter between the charge area and portable device
- The temperature of the portable device gets higher from charging
- The charging surface of the portable device is facing up
- The placement of the portable device is out of alignment with the charge area
- Near a TV tower, electric power plant, gas station, radio station, large display, airport or other facility that generates strong radio waves or electrical noise
- When the electronic key is in contact with, or is covered by the following metallic objects
 - Cards to which aluminum foil is attached
 - Cigarette boxes that have aluminum foil inside
 - Metallic wallets or bags
 - Coins
 - Hand warmers made of metal
 - Media such as CDs and DVDs
- When other wireless keys (that emit radio waves) are being used nearby

In addition, excluding the above-mentioned, when the charger does not perform normally or the operation indicator light is flashing continuously, it is considered that the wireless charger is malfunctioning. Contact your Toyota dealer.

■ To prevent failure or damage to data

- Do not bring magnetic cards, such as credit cards, or magnetic recording media, etc., close to the charger while charging, otherwise, data may disappear under the influence of magnetism. Also, do not bring precision instruments such as wrist watches, etc., close to the charger, as such objects may break.
- Do not leave portable devices in the cabin. The temperature inside the cabin may become high, when under the sun, and cause damage to the device.

■ To prevent battery discharge

When the engine is stopped, do not use the wireless charger for a long time.

Armrest

Fold down the armrest for use.

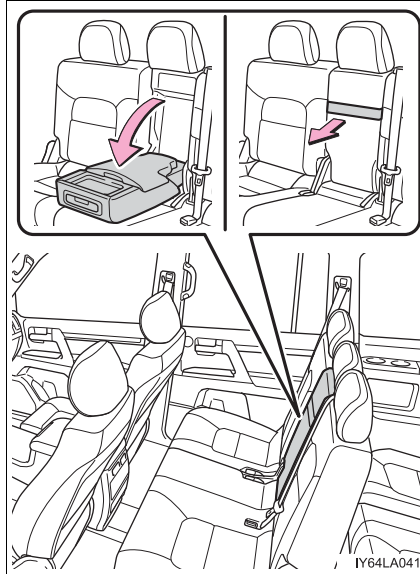

NOTICE

To prevent damage, do not apply too much load on the armrest.

Coat hooks

The coat hooks are provided with the second seat assist grips.

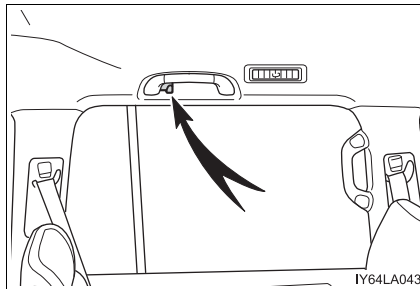

WARNING

Do not hang coat hangers or other hard or sharp objects on the hook. If the SRS curtain shield airbags deploy, these items may become projectiles, causing death or serious injury.

Assist grips

An assist grip (Type A) can be used to support your body while sitting on the seat.

An assist grip (Type B) can be used when getting in or out of the vehicle and others.

- ① Assist grip (Type A)
- ② Assist grip (Type B)

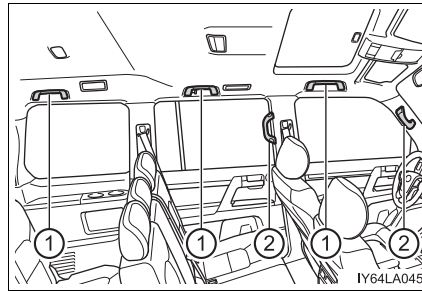

WARNING

Do not use the assist grip (Type A) when getting in or out of the vehicle or rising from your seat.

NOTICE

To prevent damage, do not hang heavy objects or put a heavy load on the assist grip.

Garage door opener

The garage door opener can be programmed to operate garage doors, gates, entry doors, door locks, home lighting systems, security systems, and other devices.

The garage door opener (HomeLink[®] Universal Transceiver) is manufactured under license from HomeLink[®].

Programming HomeLink[®] (for U.S.A. owners)

The HomeLink[®] compatible transceiver in your vehicle has 3 buttons which can be programmed to operate 3 different devices. Refer to the programming method below appropriate for the device.

- ① Buttons
- ② Indicator

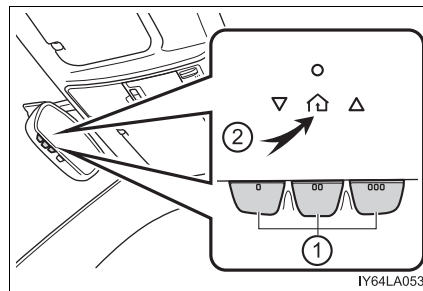

■ Programming HomeLink[®]

- 1 Point the remote control transmitter for the device 1 to 3 in. (25 to 75 mm) from the HomeLink[®] buttons.

Keep the HomeLink[®] indicator light in view while programming.

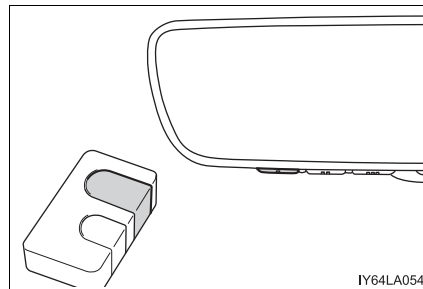

- 2 Press and hold one of the HomeLink[®] buttons and the transmitter button. When the HomeLink[®] indicator light changes from a slow to a rapid flash, you can release both buttons.

If the HomeLink[®] indicator light comes on but does not flash, flashes rapidly for 2 seconds and remains lit, the HomeLink[®] button is already programmed. Use the other buttons or follow the “Reprogramming a HomeLink[®] button” instructions. (→P. 425)

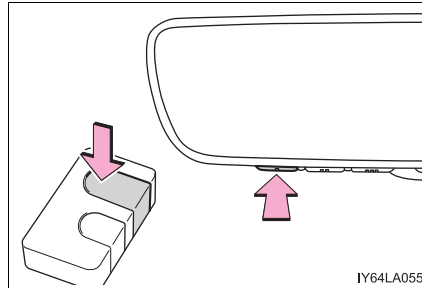

- 3 Test the HomeLink[®] operation by pressing the newly programmed button.

If a HomeLink[®] button has been programmed for a garage door, check to see if the garage door opens and closes. If the garage door does not operate, see if your remote control transmitter is of the rolling code type. Press and hold the programmed HomeLink[®] button. The remote control transmitter is of the rolling code type if the HomeLink[®] indicator light flashes rapidly for 2 seconds and then remains lit. If your transmitter is of the rolling code type, proceed to the heading “Programming a rolling code system”.

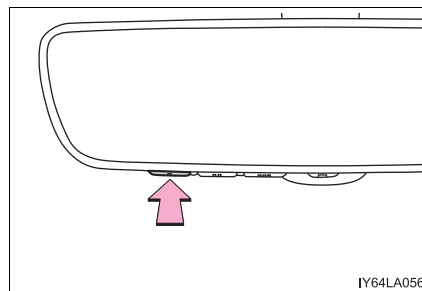

- 4 Repeat the steps above to program another device for each of the remaining HomeLink[®] buttons.

■ Programming a rolling code system

If your device is rolling code equipped, follow the steps under the heading “Programming HomeLink[®]” before proceeding with the steps listed below.

- 1 Locate the learn button on the ceiling mounted garage door opener motor. The exact location and color of the button may vary by brand of garage door opener motor.

Refer to the operation manual supplied with the garage door opener motor for the location of the learn button.

- 2 Press the learn button.

Following this step, you have 30 seconds in which to initiate 3 below.

- 3 Press and hold the vehicle’s programmed HomeLink[®] button for 2 seconds and release it. Repeat this step once again. The garage door may open.

If the garage door opens, the programming process is complete. If the door does not open, press and release the button a third time. This third press and release will complete the programming process by opening the garage door.

The ceiling mounted garage door opener motor should now recognize the HomeLink[®] signal and operate the garage door.

- 4 Repeat the steps above to program another rolling code system for any of the remaining HomeLink[®] buttons.

■ Programming an entry gate (for U.S.A. owners)/Programming all devices in the Canadian market

- 1 Place your transmitter 1 to 3 in. (25 to 75 mm) away from the surface of the HomeLink[®].

Keep the HomeLink[®] indicator light in view while programming.

- 2 Press and hold the selected HomeLink[®] button.
- 3 Repeatedly press and release (cycle) the device’s remote control button for 2 seconds each until 4 is completed.
- 4 When the indicator light on the HomeLink[®] compatible transceiver starts to flash rapidly, release the buttons.
- 5 Test the operation of the HomeLink[®] by pressing the newly programmed button. Check to see if the gate/device operates correctly.
- 6 Repeat the steps above to program another device for each of the remaining HomeLink[®] buttons.

■ **Programming other devices**

To program other devices such as home security systems, home door locks or lighting, contact your Toyota dealer for assistance.

■ **Reprogramming a button**

The individual HomeLink® buttons cannot be erased but can be reprogrammed. To reprogram a button, follow the “Reprogramming a HomeLink® button” instructions.

Operating HomeLink®

Press the appropriate HomeLink® button. The HomeLink® indicator light should come on.

The HomeLink® compatible transceiver in your vehicle continues to send a signal for up to 20 seconds as long as the button is pressed.

Reprogramming a HomeLink® button

Press and hold the desired HomeLink® button. After 20 seconds, the HomeLink® indicator light will start flashing slowly. Next, while still pressing and holding the HomeLink® button, press and hold the button on the transmitter until the HomeLink® indicator light changes from a slow to a rapid flash.

Erasing the entire HomeLink® memory (all three programs)

Press and hold the 2 outside buttons for 10 seconds until the indicator light flashes.

If you sell your vehicle, be sure to erase the programs stored in the HomeLink® memory.

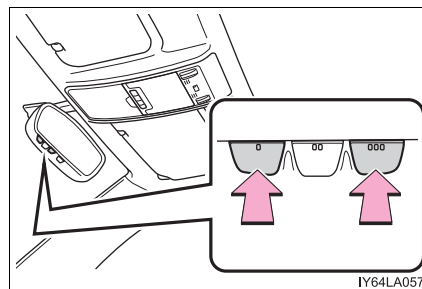

■ **Before programming**

- Install a new battery in the remote control transmitter.
- The battery side of the remote control transmitter must be pointed away from the HomeLink® button.

■ **Certification for the garage door opener**

This device complies with part 15 of the FCC Rules. Operation is subject to the following two conditions: (1) This device may not cause harmful interference, and (2) this device must accept any interference received, including interference that may cause undesired operation.

changes or modifications not expressly approved by the party responsible for compliance could void the user's authority to operate the equipment.

■ **When support is necessary**

Visit on the web at www.homelink.com or call 1-800-355-3515.

 **WARNING**

■ **When programming a garage door or other remote control devices**

The garage door or other devices may operate, so ensure people and objects are out of danger to prevent potential harm.

■ **Conforming to federal safety standards**

Do not use the HomeLink® compatible transceiver with any garage door opener or device that lacks safety stop and reverse features as required by federal safety standards.

This includes any garage door that cannot detect an interfering object. A door or device without these features increases the risk of death or serious injury.

Safety Connect*

Safety Connect is a subscription-based telematics service that uses Global Positioning System (GPS) data and embedded cellular technology to provide safety and security features to subscribers. Safety Connect is supported by Toyota's designated response center, which operates 24 hours per day, 7 days per week.

Safety Connect service is available by subscription on select, telematics hardware-equipped vehicles.

By using the Safety Connect service, you are agreeing to be bound by the Telematics Subscription Service Agreement and its Terms and Conditions, as in effect and amended from time to time, a current copy of which is available at Toyota.com. All use of the Safety Connect service is subject to such then-applicable Terms and Conditions.

System components

- ① Microphone
- ② LED light indicators
- ③ "SOS" button

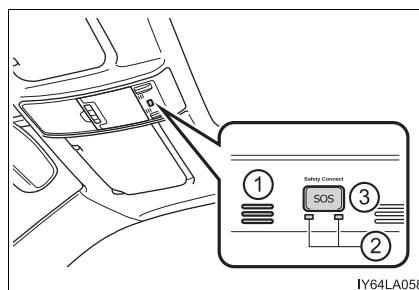

5

Interior features

*: If equipped

Services

Subscribers have the following Safety Connect services available:

- **Automatic Collision Notification***
Helps drivers receive necessary response from emergency service providers. (→P. 430)
- *: U.S. Patent No. 7,508,298 B2
- **Stolen Vehicle Location**
Helps drivers in the event of vehicle theft. (→P. 430)
- **Emergency Assistance Button (SOS)**
Connects drivers to response-center support. (→P. 430)
- **Roadside Assistance**
Provides drivers various on-road assistance. (→P. 430)

Subscription

After you have signed the Telematics Subscription Service Agreement and are enrolled, you can begin receiving services.

A variety of subscription terms is available for purchase. Contact your Toyota dealer, call 1-800-331-4331, or push the “SOS” button in your vehicle for further subscription details.

■ Safety Connect Services Information

- Phone calls using the vehicles Bluetooth® technology will not be possible during Safety Connect.
- Safety Connect is available beginning Fall 2009 on select Toyota models. Contact with the Safety Connect response center is dependent upon the telematics device being in operative condition, cellular connection availability, and GPS satellite signal reception, which can limit the ability to reach the response center or receive emergency service support. Enrollment and Telematics Subscription Service Agreement required. A variety of subscription terms is available; charges vary by subscription term selected.
- Automatic Collision Notification, Emergency Assistance, Stolen Vehicle Location, and Enhanced Roadside Assistance will function in the United States, including Hawaii and Alaska, and in Canada. No Safety Connect services will function outside of the United States in countries other than Canada.
- Safety Connect services are not subject to section 255 of the Telecommunications Act and the device is not TTY compatible.

■ Languages

The Safety Connect response center will offer support in multiple languages. The Safety Connect system will offer voice prompts in English and Spanish. Please indicate your language of choice when enrolling.

■ When contacting the response center

You may be unable to contact the response center if the network is busy.

■ Safety Connect backup battery depletion

An exclusive backup battery is built in to assist the Automatic Collision Notification, which is activated when impact above a certain level is applied to the vehicle, or when the airbags operate. This battery is a primary battery, and cannot be recharged. The red LED indicator will flash to indicate that the battery should be replaced.

The backup battery will need to be replaced if the Automatic Collision Notification operates for 60 seconds or more. For replacement, consult your Toyota dealer.

Safety Connect LED light Indicators

When the engine switch is turned to IGNITION ON mode, the red indicator light comes on for 2 seconds then turns off. Afterward, the green indicator light comes on, indicating that the service is active.

The following indicator light patterns indicate specific system usage conditions:

- Green indicator light on = Active service
- Green indicator light flashing = Safety Connect call in process
- Red indicator light (except at vehicle start-up) = System malfunction (contact your Toyota dealer)
- No indicator light (off) = Safety Connect service not active

Safety Connect services

■ **Automatic Collision Notification**

In case of either airbag deployment or severe rear-end collision, the system is designed to automatically call the response center. The responding agent receives the vehicle's location and attempts to speak with the vehicle occupants to assess the level of emergency. If the occupants are unable to communicate, the agent automatically treats the call as an emergency, contacts the nearest emergency services provider to describe the situation, and requests that assistance be sent to the location.

■ **Stolen Vehicle Location**

If your vehicle is stolen, Safety Connect can work with local authorities to assist them in locating and recovering the vehicle. After filing a police report, call the Safety Connect response center at 1-800-331-4331 and follow the prompts for Safety Connect to initiate this service.

In addition to assisting law enforcement with recovery of a stolen vehicle, Safety-Connect-equipped vehicle location data may, under certain circumstances, be shared with third parties to locate your vehicle. Further information is available at Toyota.com.

■ **Emergency Assistance Button (“SOS”)**

In the event of an emergency on the road, push the “SOS” button to reach the Safety Connect response center. The answering agent will determine your vehicle's location, assess the emergency, and dispatch the necessary assistance required.

If you accidentally press the “SOS” button, tell the response-center agent that you are not experiencing an emergency.

■ **Roadside Assistance**

Subscribers can press the “SOS” button to reach a Safety Connect response-center agent, who can help with a wide range of needs, such as: towing, flat tire, fuel delivery, etc. For a description of the Roadside Assistance services and their limitations, please see the Safety Connect Terms and Conditions, which are available at Toyota.com.

Safety information for Safety Connect

Important! Read this information before using Safety Connect.

■ Exposure to radio frequency signals

The Safety Connect system installed in your vehicle is a low-power radio transmitter and receiver. It receives and also sends out radio frequency (RF) signals.

In August 1996, the Federal Communications Commission (FCC) adopted RF exposure guidelines with safety levels for mobile wireless phones. Those guidelines are consistent with the safety standards previously set by the following U.S. and international standards bodies.

- ANSI (American National Standards Institute) C95.1 [1992]
- NCRP (National Council on Radiation Protection and Measurement) Report 86 [1986]
- ICNIRP (International Commission on Non-Ionizing Radiation Protection) [1996]

Those standards were based on comprehensive and periodic evaluations of the relevant scientific literature. Over 120 scientists, engineers, and physicians from universities, and government health agencies and industries reviewed the available body of research to develop the ANSI Standard (C95.1).

The design of Safety Connect complies with the FCC guidelines in addition to those standards.

■ Certification for Safety Connect

FCC ID: O6Y-CDMRF101
FCC ID: XOECDMRF101B
FCC ID: N7NGTM2

FCC WARNING:

This equipment complies with FCC radiation exposure limits set forth for an uncontrolled environment and meets the FCC radio frequency (RF) Exposure Guidelines in Supplement C to OET65. This equipment should be installed and operated keeping the radiator at least 20cm or more away from person's body (excluding extremities: hands, wrists, feet and ankles).

Maintenance and care**6**

- 6-1. Maintenance and care**
 - Cleaning and protecting the vehicle exterior..... 434
 - Cleaning and protecting the vehicle interior..... 437
- 6-2. Maintenance**
 - Maintenance requirements 440
 - General maintenance..... 443
 - Emission inspection and maintenance (I/M) programs..... 446
- 6-3. Do-it-yourself maintenance**
 - Do-it-yourself service precautions 447
 - Hood 449
 - Engine compartment..... 450
 - Tires 463
 - Tire inflation pressure 472
 - Wheels 475
 - Air conditioning filter..... 477
 - Electronic key battery..... 479
 - Checking and replacing fuses 481
 - Headlight aim 485
 - Light bulbs..... 487

Cleaning and protecting the vehicle exterior

Perform the following to protect the vehicle and maintain it in prime condition:

- Working from top to bottom, liberally apply water to the vehicle body, wheel wells and underside of the vehicle to remove any dirt and dust.
- Wash the vehicle body using a sponge or soft cloth, such as a chamois.
- For hard-to-remove marks, use car wash soap and rinse thoroughly with water.
- Wipe away any water.
- Wax the vehicle when the waterproof coating deteriorates.
If water does not bead on a clean surface, apply wax when the vehicle body is cool.

■ Automatic car washes

- Fold the mirrors back before washing the vehicle. Start washing from the front of the vehicle. Make sure to extend the mirrors before driving.
- Brushes used in automatic car washes may scratch the vehicle surface and harm your vehicle's paint.
- Rear spoiler (if equipped) may not be washable in some automatic car washes. There may also be an increased risk of damage to vehicle.

■ High pressure car washes

- Do not allow the nozzles of the car wash to come within close proximity of the windows.
- Before using the car wash, check that the fuel filler door on your vehicle is closed properly.

■ Aluminum wheels

- Remove any dirt immediately by using a neutral detergent. Do not use hard brushes or abrasive cleaners. Do not use strong or harsh chemical cleaners. Use the same mild detergent and wax as used on the paint.
- Do not use detergent on the wheels when they are hot, for example after driving for long distance in the hot weather.
- Wash detergent from the wheels immediately after use.

■ Bumpers and side moldings

Do not scrub with abrasive cleaners.

■ Notes for a smart key system (if equipped)

- If the door handle becomes wet while the electronic key is within the effective range, the door may lock and unlock repeatedly. Place the key in a position 2 m (6 ft.) or more separate from the vehicle while the vehicle is being washed. (Take care to ensure that the key is not stolen.)
- If the electronic key is inside the vehicle and a door handle becomes wet during a car wash, a message may be shown on the multi-information display and a buzzer will sound outside the vehicle. To turn off the alarm, lock all the doors.

⚠ WARNING

■ When washing the vehicle

Do not apply water to the inside of the engine compartment. Doing so may cause the electrical components etc. to catch fire.

■ When cleaning the windshield (vehicles with rain-sensing windshield wiper)

Set the wiper switch to off.

If the wiper switch is in "AUTO", the wipers may operate unexpectedly in the following situations, and may result in hands being caught or other serious injuries and cause damage to the wiper blades.

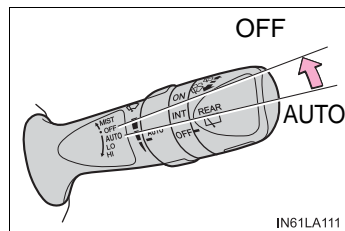

- When the upper part of the windshield where the raindrop sensor is located is touched by hand
- When a wet rag or similar is held close to the raindrop sensor
- If something bumps against the windshield
- If you directly touch the raindrop sensor body or if something bumps into the raindrop sensor

■ Precautions regarding the exhaust pipe

Exhaust gasses cause the exhaust pipe to become quite hot.

When washing the vehicle, be careful not to touch the pipe until it has cooled sufficiently, as touching a hot exhaust pipe can cause burns.

■ Precautions regarding the Blind Spot Monitor (if equipped)

If the paint of the rear bumper is chipped or scratched, the system may malfunction.

If this occurs, consult your Toyota dealer.

 NOTICE**■ To prevent paint deterioration and corrosion on the body and components (aluminum wheels etc.)**

- Wash the vehicle immediately in the following cases:
 - After driving near the sea coast
 - After driving on salted roads
 - If coal tar or tree sap is present on the paint surface
 - If you see dead insects, insect droppings or bird droppings on the paint
 - After driving in an area contaminated with soot, oily smoke, mine dust, iron powder or chemical substances
 - If the vehicle becomes heavily soiled in dust or mud
 - If liquids such as benzene and gasoline are spilled on the paint surface
- If the paint is chipped or scratched, have it repaired immediately.
- To prevent the wheels from corroding, remove any dirt and store in a place with low humidity when storing wheels.

■ Cleaning the exterior lights

- Wash carefully. Do not use organic substances or scrub with a hard brush. This may damage the surfaces of the lights.
- Do not apply wax on the surfaces of the lights. Wax may cause damage to the lenses.

■ When using an automatic car wash (vehicles with rain-sensing windshield wiper)

Turn off the wiper switch.
If the wiper switch is in "AUTO", the wipers may operate and the wiper blades may be damaged.

■ When using a high pressure car wash

Do not bring the nozzle tip close to boots (rubber or resin manufactured cover), connectors or the following parts. The parts may be damaged if they come into contact with high-pressure water.

- Traction related parts
- Steering parts
- Suspension parts
- Brake parts

Cleaning and protecting the vehicle interior

The following procedures will help protect your vehicle's interior and keep it in top condition:

Protecting the vehicle interior

Remove dirt and dust using a vacuum cleaner. Wipe dirty surfaces with a cloth dampened with lukewarm water.

If dirt cannot be removed, wipe it off with neutral detergent diluted to approximately 1%.

Cleaning the leather areas

- Remove dirt and dust using a vacuum cleaner.
- Wipe any excess dirt and dust with a soft cloth dampened with diluted detergent.
Use a diluted water solution of approximately 5% neutral wool detergent.
- Wring out any excess water from the cloth and thoroughly wipe off all remaining traces of detergent.
- Wipe the surface with a dry, soft cloth to remove any remaining moisture. Allow the leather to dry in a shaded ventilated area.

Cleaning the synthetic leather areas

- Remove loose dirt using a vacuum cleaner.
- Apply a mild soap solution to the synthetic leather using a sponge or soft cloth.
- Allow the solution to soak in for a few minutes. Remove the dirt and wipe off the solution with a clean, damp cloth.

■ Caring for leather areas

Toyota recommends cleaning the interior of the vehicle at least twice a year to maintain the quality of the vehicle's interior.

■ Shampooing the carpets

There are several commercial foaming-type cleaners available. Use a sponge or brush to apply the foam. Rub in overlapping circles. Do not use water. The excellent results are obtained when keeping the carpet as dry as possible.

■ Seat belts

Clean with mild soap and lukewarm water using a cloth or sponge. Also check the belts periodically for excessive wear, fraying or cuts.

⚠ WARNING**■ Water in the vehicle**

- Do not splash or spill liquid in the vehicle.
Doing so may cause electrical components etc. to malfunction or catch fire.
- Do not get any of the SRS components or wiring in the vehicle interior wet.
(→P. 40)
An electrical malfunction may cause the airbags to deploy or not function properly, resulting in death or serious injury.

■ Cleaning the interior (especially instrument panel)

Do not use polish wax or polish cleaner. The instrument panel may reflect off the windshield, obstructing the driver's view and leading to an accident, resulting in death or serious injury.

⚠ NOTICE**■ Cleaning detergents**

- Do not use the following types of detergent, as they may discolor the vehicle interior or cause streaks or damage to painted surfaces:
 - Non-seat portions: Organic substances such as benzene or gasoline, alkaline or acidic solutions, dye, and bleach
 - Seats: Alkaline or acidic solutions, such as thinner, benzene, and alcohol
- Do not use polish wax or polish cleaner. The instrument panel's or other interior part's painted surface may be damaged.

 NOTICE**■ Preventing damage to leather surfaces**

Observe the following precautions to avoid damage to and deterioration of leather surfaces:

- Remove any dust or dirt from leather surfaces immediately.
- Do not expose the vehicle to direct sunlight for extended periods of time. Park the vehicle in the shade, especially during summer.
- Do not place items made of vinyl, plastic, or containing wax on the upholstery, as they may stick to the leather surface if the vehicle interior heats up significantly.

■ When cleaning the inside of the windshield (vehicles with Toyota Safety Sense P)

Do not allow glass cleaner to contact the lens. Also, do not touch the lens. (→P. 230)

■ Water on the floor

Do not wash the vehicle floor with water.

Vehicle systems such as the audio system may be damaged if water comes into contact with electrical components such as the audio system above or under the floor of the vehicle. Water may also cause the body to rust.

■ Cleaning the inside of the rear quarter windows and rear window

- Do not use glass cleaner to clean the rear quarter windows and rear window, as this may cause damage to the rear window defogger heater wires or antenna. Use a cloth dampened with lukewarm water to gently wipe the window clean. Wipe the window in strokes running parallel to the heater wires or antenna.
- Be careful not to scratch or damage the heater wires or antenna.

Maintenance requirements

To ensure safe and economical driving, day-to-day care and regular maintenance are essential. It is the owner's responsibility to perform regular checks. Toyota recommends the following maintenance:

General maintenance

General maintenance should be performed on a daily basis. This can be done by yourself or by a Toyota dealer.

Scheduled maintenance

Scheduled maintenance should be performed at specified intervals according to the maintenance schedule.

For details about maintenance items and schedules, refer to the "Scheduled Maintenance Guide" or "Owner's Manual Supplement".

Do-it-yourself maintenance

You can perform some maintenance procedures by yourself.

Please be aware that do-it-yourself maintenance may affect warranty coverage.

The use of Toyota repair manuals is recommended.

For details about warranty coverage, see the "Owner's Warranty Information Booklet" or "Owner's Manual Supplement".



■ Repair and replacement

It is recommended that genuine Toyota parts be used for repairs to ensure performance of each system. If non-Toyota parts are used in replacement or if a repair shop other than a Toyota dealer performs repairs, confirm the warranty coverage.

■ Resetting the message indicating maintenance is required

After the required maintenance is performed according to the maintenance schedule, please reset the message.

To reset the message, follow the procedures described below:

- 1 Press < or > of the meter control switches, select .
- 2 Press ^ or v of the meter control switches, select "Scheduled Maintenance" and then press .
- 3 Select the "Yes" and press .
- 4 A message is displayed on the multi-information display.

■ Allow inspection and repairs to be performed by a Toyota dealer

- Toyota technicians are well-trained specialists and are kept up to date with the latest service information. They are well informed about the operation of all systems on your vehicle.
- Keep a copy of the repair order. It proves that the maintenance that has been performed is under warranty coverage. If any problem should arise while your vehicle is under warranty, your Toyota dealer will promptly take care of it.

 **WARNING**

■ **If your vehicle is not properly maintained**

Improper maintenance could result in serious damage to the vehicle and possible serious injury or death.

■ **Handling of the battery**

- Engine exhaust, some of its constituents, and a wide variety of automobile components contain or emit chemicals known to the State of California to cause cancer and birth defects and other reproductive harm. Work in a well ventilated area.
- Oils, fuels and fluids contained in vehicles as well as waste produced by component wear contain or emit chemicals known to the State of California to cause cancer and birth defects or other reproductive harm. Avoid exposure and wash any affected area immediately.
- Battery posts, terminals and related accessories contain lead and lead compounds which are known to cause brain damage. Wash your hands after handling. (→P. 459)

General maintenance

Listed below are the general maintenance items that should be performed at the intervals specified in the “Warranty and Service Guide” or “Owner’s Manual Supplement”. It is recommended that any problem you notice should be brought to the attention of your Toyota dealer or qualified service shop for advice.

Engine compartment

Items	Check points
Battery	Check the connections. (→P. 459)
Brake fluid	Is the brake fluid at the correct level? (→P. 456)
Engine coolant	Is the engine coolant at the correct level? (→P. 455)
Engine oil	Is the engine oil at the correct level? (→P. 452)
Exhaust system	There should not be any fumes or strange sounds.
Power steering fluid	Is the power steering fluid at the correct level? (→P. 458)
Radiator/condenser	The radiator and condenser should be free from foreign objects. (→P. 456)
Washer fluid	Is there sufficient washer fluid? (→P. 462)

Vehicle interior

Items	Check points
Accelerator pedal	<ul style="list-style-type: none"> The accelerator pedal should move smoothly (without uneven pedal effort or catching).
Automatic transmission "Park" mechanism	<ul style="list-style-type: none"> When parked on a slope and the shift lever is in P, is the vehicle securely stopped?
Brake pedal	<ul style="list-style-type: none"> Does the brake pedal move smoothly? Does the brake pedal have appropriate clearance from the floor? (→P. 558) Does the brake pedal have the correct amount of free play? (→P. 558)
Brakes	<ul style="list-style-type: none"> The vehicle should not pull to one side when the brakes are applied. The brakes should work effectively. The brake pedal should not feel spongy. The brake pedal should not get too close to the floor when the brakes are applied.
Head restraints	<ul style="list-style-type: none"> Do the head restraints move smoothly and lock securely?
Indicators/buzzers	<ul style="list-style-type: none"> Do the indicators and buzzers function properly?
Lights	<ul style="list-style-type: none"> Do all the lights come on? Are the headlights aimed correctly? (→P. 485)
Parking brake	<ul style="list-style-type: none"> Does the parking brake lever move smoothly? When parked on a slope and the parking brake is on, is the vehicle securely stopped?
Seat belts	<ul style="list-style-type: none"> Do the seat belts operate smoothly? The seat belts should not be damaged.
Seats	<ul style="list-style-type: none"> Do the seat controls operate properly?
Steering wheel	<ul style="list-style-type: none"> Does the steering wheel rotate smoothly? Does the steering wheel have the correct amount of free play? There should not be any strange sounds coming from the steering wheel.

Vehicle exterior

Items	Check points
Doors	<ul style="list-style-type: none"> • Do the doors operate smoothly?
Engine hood	<ul style="list-style-type: none"> • Does the engine hood lock system work properly?
Fluid leaks	<ul style="list-style-type: none"> • There should not be any signs of fluid leakage after the vehicle has been parked.
Tires	<ul style="list-style-type: none"> • Is the tire inflation pressure correct? • The tires should not be damaged or excessively worn. • Have the tires been rotated according to the maintenance schedule? • The wheel nuts should not be loose.
Windshield wipers/rear window wiper	<ul style="list-style-type: none"> • The wiper blades should not show any signs of cracking, splitting, wear, contamination or deformation. • The wiper blades should clear the windshield/rear window without streaking or skipping.

 **WARNING**

■ If the engine is running

Turn off the engine and ensure that there is adequate ventilation before performing maintenance checks.

Emission inspection and maintenance (I/M) programs

Some states have vehicle emission inspection programs which include OBD (On Board Diagnostics) checks. The OBD system monitors the operation of the emission control system.

If the malfunction indicator lamp comes on

The OBD system determines that a problem exists somewhere in the emission control system. Your vehicle may not pass the I/M test and may need to be repaired. Contact your Toyota dealer to service the vehicle.

Your vehicle may not pass the I/M test in the following situations:

- When the battery is disconnected or discharged
Readiness codes that are set during ordinary driving are erased. Also, depending on your driving habits, the readiness codes may not be completely set.
- When the fuel tank cap is loose
The malfunction indicator lamp comes on indicating a temporary malfunction and your vehicle may not pass the I/M test.

When the malfunction indicator lamp still remains on after several driving trips

The error code in the OBD system will not be cleared unless the vehicle is driven 40 or more times.

If your vehicle does not pass the I/M test

Contact your Toyota dealer to prepare the vehicle for re-testing.

Do-it-yourself service precautions

If you perform maintenance yourself, be sure to follow the correct procedures as given in these sections.

Items	Parts and tools
Battery condition (→P. 459)	<ul style="list-style-type: none"> • Warm water • Baking soda • Grease • Conventional wrench (for terminal clamp bolts)
Brake fluid level (→P. 456)	<ul style="list-style-type: none"> • FMVSS No.116 DOT 3 or SAE J1703 brake fluid • Rag or paper towel • Funnel (used only for adding brake fluid)
Engine coolant level (→P. 455)	<ul style="list-style-type: none"> • “Toyota Super Long Life Coolant” or similar high quality ethylene glycol-based non-silicate, non-amine, non-nitrite and non-borate coolant with long-life hybrid organic acid technology. • “Toyota Super Long Life Coolant” is pre-mixed with 50 % coolant and 50 % deionized water. • Funnel (used only for adding coolant)
Engine oil level (→P. 452)	<ul style="list-style-type: none"> • “Toyota Genuine Motor Oil” or equivalent • Rag or paper towel • Funnel (used only for adding engine oil)
Fuses (→P. 481)	<ul style="list-style-type: none"> • Fuse with same amperage rating as original
Headlight aim (→P. 485)	<ul style="list-style-type: none"> • Phillips-head screwdriver
Light bulbs (→P. 487)	<ul style="list-style-type: none"> • Bulb with same number and wattage rating as original • Phillips-head screwdriver • Flathead screwdriver • Wrench
Power steering fluid level (→P. 458)	<ul style="list-style-type: none"> • Automatic transmission fluid DEXRON® II or III • Rag or paper towel • Funnel (used only for adding power steering fluid)
Radiator and condenser (→P. 456)	—
Tire inflation pressure (→P. 472)	<ul style="list-style-type: none"> • Tire pressure gauge • Compressed air source

Items	Parts and tools
Washer fluid (→P. 462)	<ul style="list-style-type: none"> • Water or washer fluid containing antifreeze (for winter use) • Funnel (used only for adding water or washer fluid)

 **WARNING**

The engine compartment contains many mechanisms and fluids that may move suddenly, become hot, or become electrically energized. To avoid death or serious injury, observe the following precautions:

■ **When working on the engine compartment**

- Keep hands, clothing and tools away from the moving fan and engine drive belt.
- Be careful not to touch the engine, radiator, exhaust manifold, etc. right after driving as they may be hot. Oil and other fluids may also be hot.
- Do not leave anything that may burn easily, such as paper or rags, in the engine compartment.
- Do not smoke, cause sparks or expose an open flame to fuel or the battery. Fuel and battery fumes are flammable.
- Be extremely cautious when working on the battery. It contains poisonous and corrosive sulfuric acid.

■ **When working near the electric cooling fans or radiator grille**

Be sure the engine switch is off. With the engine switch in IGNITION ON mode, the electric cooling fans may automatically start to run if the air conditioning is on and/or the coolant temperature is high. (→P. 456)

■ **When working on or under the vehicle**

Do not get under the vehicle with just the jack supporting it. Always use automotive jack stands or other solid supports.

■ **Safety glasses**

Wear safety glasses to prevent flying or falling material, fluid spray, etc. from getting in your eyes.

 **NOTICE**

■ **If you remove the air cleaner filter**

Driving with the air cleaner filter removed may cause excessive engine wear due to dirt in the air.

Hood

Release the lock from the inside of the vehicle to open the hood.

- 1 Pull the hood lock release lever.
The hood will pop up slightly.

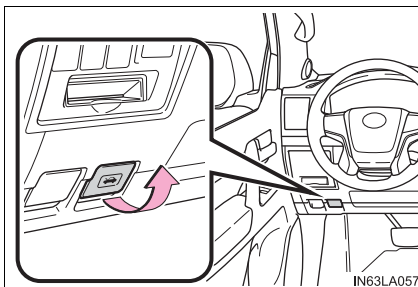

- 2 Lift the hood catch and lift the hood.

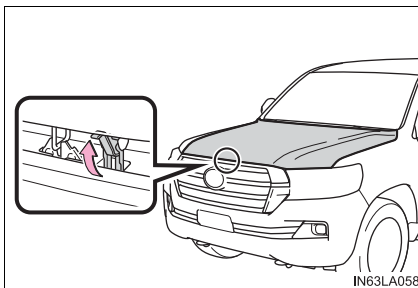

WARNING

Pre-driving check

Check that the hood is fully closed and locked.
If the hood is not locked properly, it may open while the vehicle is in motion and cause an accident, which may result in death or serious injury.

Engine compartment

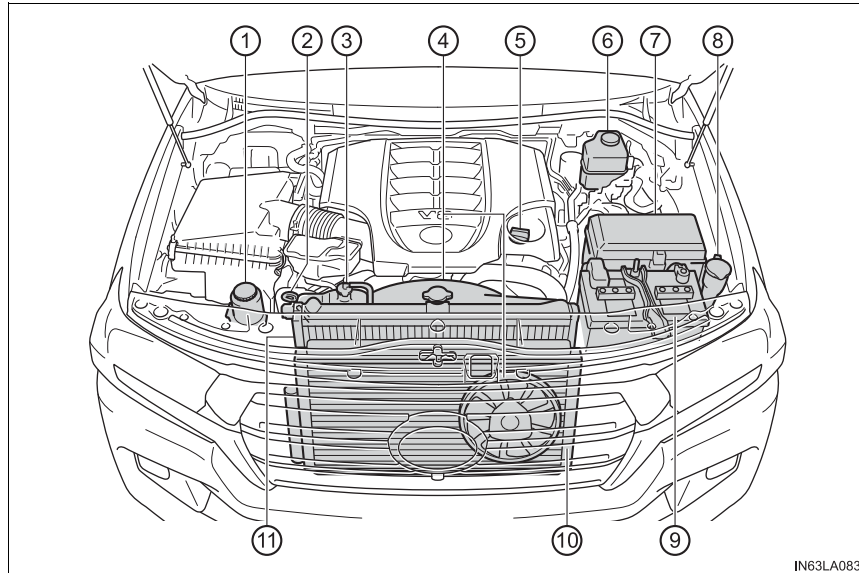

IN63LA083

- | | |
|---|--------------------------------------|
| ① Power steering fluid reservoir
(→P. 458) | ⑥ Brake fluid reservoir
(→P. 456) |
| ② Engine oil level dipstick
(→P. 452) | ⑦ Fuse box
(→P. 481) |
| ③ Engine coolant reservoir
(→P. 455) | ⑧ Washer fluid tank
(→P. 462) |
| ④ Cooling fans
(→P. 456) | ⑨ Battery
(→P. 459) |
| ⑤ Engine oil filler cap (→P. 453) | ⑩ Condenser
(→P. 456) |
| | ⑪ Radiator
(→P. 456) |

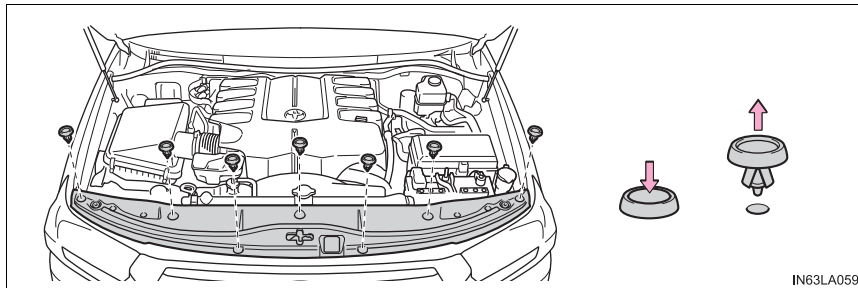
Engine compartment cover**■ Removing the engine compartment cover****■ Installing the clips**

- ① Push up center portion
- ② Insert
- ③ Press

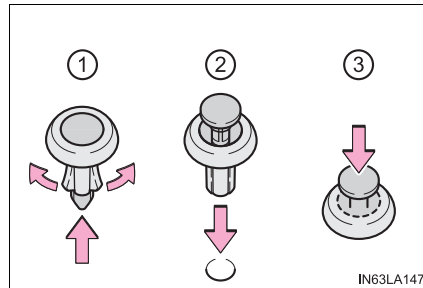
 **NOTICE****■ After installing an engine compartment cover**

Make sure the cover is securely installed in its original position.

Engine oil

With the engine at operating temperature and turned off, check the oil level on the dipstick.

■ Checking the engine oil

- 1 Park the vehicle on level ground. After warming up the engine and turning it off, wait more than 5 minutes for the oil to drain back into the bottom of the engine.
- 2 Holding a rag under the end, pull the dipstick out.

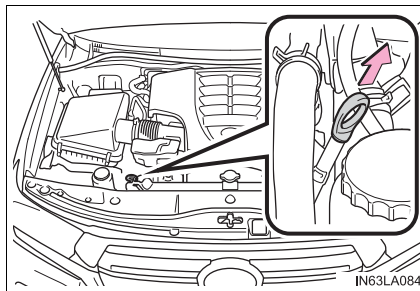

- 3 Wipe the dipstick clean.
- 4 Reinsert the dipstick fully.
- 5 Holding a rag under the end, pull the dipstick out and check the oil level.

- ① Low
- ② Normal
- ③ Excessive

The shape of the dipstick may differ depending on the type of vehicle or engine.

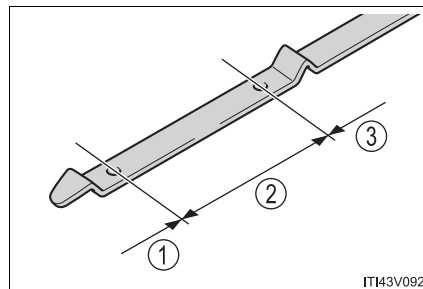

- 6 Wipe the dipstick and reinsert it fully.

■ Adding engine oil

If the oil level is below or near the low level mark, add engine oil of the same type as already in the engine.

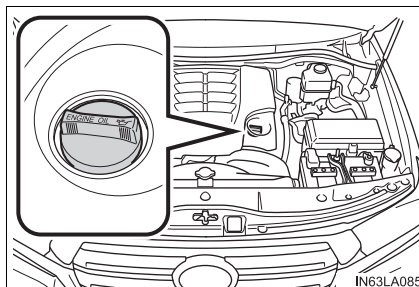

Make sure to check the oil type and prepare the items needed before adding oil.

Engine oil selection	→P. 554
Oil quantity (Low → Full)	1.6 qt. (1.5 L, 1.3 Imp.qt.)
Items	Clean funnel

- 1 Remove the oil filler cap by turning it counterclockwise.
- 2 Add engine oil slowly, checking the dipstick.
- 3 Install the oil filler cap by turning it clockwise.



■ Engine oil consumption

A certain amount of engine oil will be consumed while driving. In the following situations, oil consumption may increase, and engine oil may need to be refilled in between oil maintenance intervals.

- When the engine is new, for example directly after purchasing the vehicle or after replacing the engine
- If low quality oil or oil of an inappropriate viscosity is used
- When driving at high engine speeds or with a heavy load, when towing, or when driving while accelerating or decelerating frequently
- When leaving the engine idling for a long time, or when driving frequently through heavy traffic

■ After changing the engine oil

The engine oil maintenance data should be reset. Perform the following procedures:

- 1 Press < or > of the meter control switches, select .
- 2 Press ^ or v of the meter control switches, select "Oil Maintenance" and then press .
- 3 Select the "Yes" and press .
- 4 A message is displayed on the multi-information display.

WARNING

■ Used engine oil

- Used engine oil contains potentially harmful contaminants which may cause skin disorders such as inflammation or skin cancer, so care should be taken to avoid prolonged and repeated contact. To remove used engine oil from your skin, wash thoroughly with soap and water.
- Dispose of used oil and filters only in a safe and acceptable manner. Do not dispose of used oil and filters in household trash, in sewers or onto the ground. Call your Toyota dealer, service station or auto parts store for information concerning recycling or disposal.
- Do not leave used engine oil within the reach of children.

NOTICE

■ To prevent serious engine damage

Check the oil level on regular basis.

■ When replacing the engine oil

- Be careful not to spill engine oil on the vehicle components.
- Avoid overfilling, or the engine could be damaged.
- Check the oil level on the dipstick every time you refill the vehicle.
- Be sure the engine oil filler cap is properly tightened.

Engine coolant

The coolant level is satisfactory if it is between the “F” and “L” lines on the reservoir when the engine is cold.

- ① Reservoir cap
- ② “F”
- ③ “L”

If the level is on or below the “L” line, add coolant up to the “F” line.

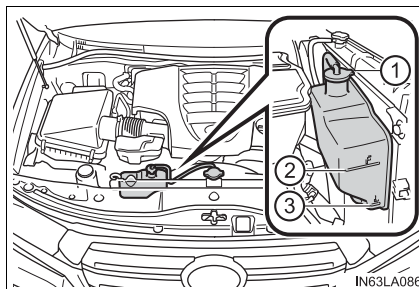

■ Coolant selection

Only use “Toyota Super Long Life Coolant” or a similar high quality ethylene glycol based non-silicate, non-amine, non-nitrite, and non-borate coolant with long-life hybrid organic acid technology.

“Toyota Super Long Life Coolant” is a mixture of 50 % coolant and 50 % deionized water. (Minimum temperature: -31°F [-35°C])

For more details about engine coolant, contact your Toyota dealer.

■ If the coolant level drops within a short time of replenishing

Visually check the radiator, hoses, engine coolant reservoir caps, drain cock and water pump. If you cannot find a leak, have your Toyota dealer test the cap and check for leaks in the cooling system.

⚠ WARNING

■ When the engine is hot

Do not remove the radiator cap.
The cooling system may be under pressure and may spray hot coolant if the cap is removed, causing serious injuries, such as burns.

⚠ NOTICE

■ When adding coolant

Coolant is neither plain water nor straight antifreeze. The correct mixture of water and antifreeze must be used to provide proper lubrication, corrosion protection and cooling. Be sure to read the antifreeze or coolant label.

■ If you spill coolant

Be sure to wash it off with water to prevent it from damage to parts or paint.

Radiator and condenser

Check the radiator and condenser and clear any foreign objects. If either of the above parts is extremely dirty or you are not sure of their condition, have your vehicle checked by your Toyota dealer.

WARNING

■ When the engine is hot

Do not touch the radiator or condenser as they may be hot and cause serious injuries, such as burns.

Brake fluid

■ Checking fluid level

The brake fluid level should be between the “MAX” and “MIN” lines on the tank.

- ① “MAX” line
- ② “MIN” line

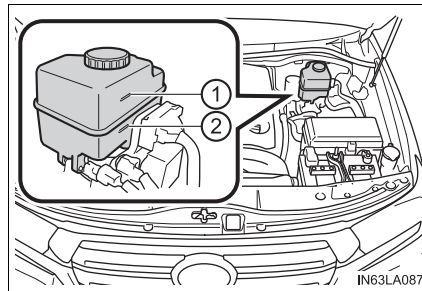

■ Adding fluid

Make sure to check the fluid type and prepare the necessary item.

Fluid type	FMVSS No.116 DOT 3 or SAE J1703 brake fluid
Items	Clean funnel

■ Refilling brake fluid

- 1 Turn the engine switch off.
- 2 Depress the brake pedal more than 40 times.
- 3 Remove the reservoir cap by hand. Add brake fluid up to the “MAX” line.

If you do not follow the procedure above, the reservoir may overflow.

■ Brake fluid can absorb moisture from the air

Excess moisture in the fluid can cause a dangerous loss of braking efficiency. Use only newly opened brake fluid.

 **WARNING****■ When filling the reservoir**

Take care because brake fluid can harm your hands or eyes and damage painted surfaces. If fluid gets on your eyes, flush the affected area with clean water immediately. If you still experience discomfort, see a doctor.

 **NOTICE****■ If the fluid level is low or high**

It is normal for the brake fluid level to go down slightly as the brake pads wear or when the fluid level in the accumulator is high. If the reservoir needs frequent refilling, it may indicate a serious problem.

Power steering fluid

■ **Fluid level**

The fluid level should be within the appropriate range.

- ① Full (when hot)
- ② Add fluid (when hot)
- ③ Full (when cold)
- ④ Add fluid (when cold)

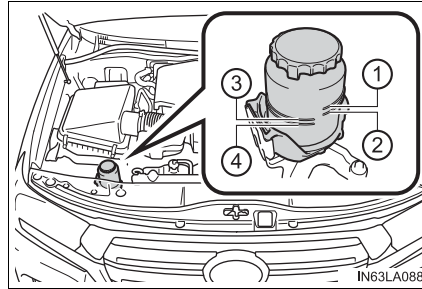

Hot: The vehicles has been driven around 50 mph (80 km/h) for 20 minutes, or slightly longer in frigid temperatures. (Fluid temperature, 140°F - 175°F [60°C - 80°C]).

Cold: The engine has not been run for about 5 hours. (Room temperature, 50°F - 85°F [10°C - 30°C]).

■ **Checking the fluid level**

Make sure to check the fluid type and prepare the necessary items.

Fluid type	Automatic transmission fluid DEXRON® II or III
Items	Rag or paper, clean funnel (only for adding fluid)

- ① Clean all dirt off the reservoir.
- ② Remove the cap by turning it counterclockwise.
- ③ Wipe the dipstick clean.
- ④ Reinstall the cap and remove it again.
- ⑤ Check the fluid level.

⚠ WARNING**■ When checking the reservoir**

Take care as the reservoir may be hot.

⚠ NOTICE**■ When adding fluid**

Avoid overfilling, or the power steering may be damaged.

■ After replacing the reservoir cap

Check the steering box case, vane pump and hose connections for leaks or damage.

Battery

Check the battery as follows.

■ Battery exterior

Make sure that the battery terminals are not corroded and that there are no loose connections, cracks, or loose clamps.

- ① Terminals
- ② Hold-down clamp

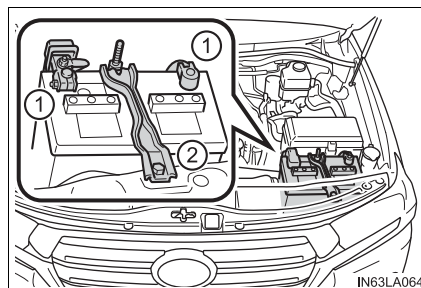

■ Before recharging

When recharging, the battery produces hydrogen gas which is flammable and explosive. Therefore, observe the following before recharging:

- If recharging with the battery installed on the vehicle, be sure to disconnect the ground cable.
- Make sure the power switch on the charger is off when connecting and disconnecting the charger cables to the battery.

■ After recharging/reconnecting the battery

The engine may not start. Follow the procedure below to initialize the system.

- 1 Shift the shift lever to P
 - 2 Open and close any of the doors.
 - 3 Restart the engine.
- Unlocking the doors using the smart key system may not be possible immediately after reconnecting the battery. If this happens, use the wireless remote control or the mechanical key to lock/unlock the doors.
 - Start the engine with the engine switch in ACCESSORY mode. The engine may not start with the engine switch turned off. However, the engine will operate normally from the second attempt.
 - The engine switch mode is recorded by the vehicle. If the battery is reconnected, the vehicle will return the engine switch mode to the status it was in before the battery was disconnected. Make sure to turn off the engine before disconnect the battery. Take extra care when connecting the battery if the engine switch mode prior to discharge is unknown.

If the engine will not start even after multiple attempts at both methods, contact your Toyota dealer.

⚠ WARNING**■ Chemicals in the battery**

Batteries contain poisonous and corrosive sulfuric acid and may produce hydrogen gas which is flammable and explosive. To reduce the risk of death or serious injury, take the following precautions while working on or near battery:

- Do not cause sparks by touching the battery terminals with tools.
- Do not smoke or light a match near the battery.
- Avoid contact with eyes, skin and clothes.
- Never inhale or swallow electrolyte.
- Wear protective safety glasses when working near the battery.
- Keep children away from the battery.

■ Where to safely charge the battery

Always charge the battery in an open area. Do not charge the battery in a garage or closed room where there is not sufficient ventilation.

 **WARNING****■ How to recharge the battery**

Only perform a slow charge (5A or less). The battery may explode if charged at a quicker rate.

■ Emergency measures regarding electrolyte

- If electrolyte gets in your eyes
Flush your eyes with clean water for at least 15 minutes and get immediate medical attention. If possible, continue to apply water with a sponge or cloth while traveling to the nearest medical facility.
- If electrolyte gets on your skin
Wash the affected area thoroughly. If you feel pain or burning, get medical attention immediately.
- If electrolyte gets on your clothes
It can soak through clothing on to your skin. Immediately take off the clothing and follow the procedure above if necessary.
- If you accidentally swallow electrolyte
Drink a large quantity of water or milk. Get emergency medical attention immediately.

 **NOTICE****■ When recharging the battery**

Never recharge the battery while the engine is running. Also, be sure all accessories are turned off.

Washer fluid

If any washer does not work or the warning message appears on the multi-information display, the washer tank may be empty. Add washer fluid.

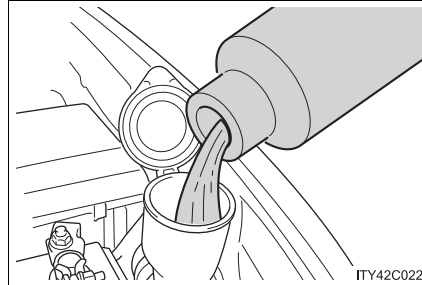

WARNING

■ When adding washer fluid

Do not add washer fluid when the engine is hot or running as washer fluid contains alcohol and may catch fire if spilled on the engine etc.

NOTICE

■ Do not use any fluid other than washer fluid

Do not use soapy water or engine antifreeze instead of washer fluid. Doing so may cause streaking on the vehicle's painted surfaces.

■ Diluting washer fluid

Dilute washer fluid with water as necessary. Refer to the freezing temperatures listed on the label of the washer fluid bottle.

Tires

Replace or rotate tires in accordance with maintenance schedules and treadwear.

Checking tires

Check if the treadwear indicators are showing on the tires. Also check the tires for uneven wear, such as excessive wear on one side of the tread. Check the spare tire condition and pressure if not rotated.

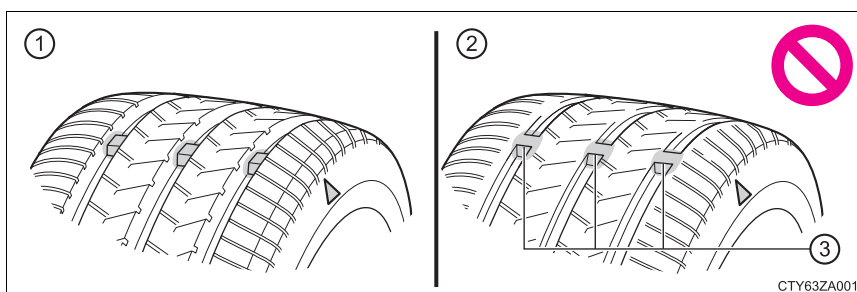

- ① New tread
- ② Worn tread
- ③ Treadwear indicator

The location of treadwear indicators is shown by the “TWI” or “△” mark, etc., molded into the sidewall of each tire.

Replace the tires if the treadwear indicators are showing on a tire.

Tire rotation

Rotate the tires in the order shown.

To equalize tire wear and extend tire life, Toyota recommends that tire rotation is carried out at the same interval as tire inspection.

Do not fail to initialize the tire pressure warning system after tire rotation.

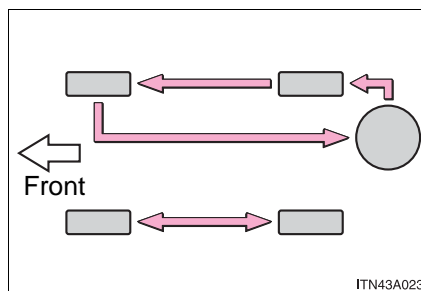

Tire pressure warning system

Your Toyota is equipped with a tire pressure warning system that uses tire pressure warning valves and transmitters to detect low tire inflation pressure before serious problems arise.

- If the tire pressure drops below a predetermined level, the driver is warned by a screen display and a warning light. (→P. 512)
- The tire pressure detected by the tire pressure warning system can be displayed on the multi-information display.

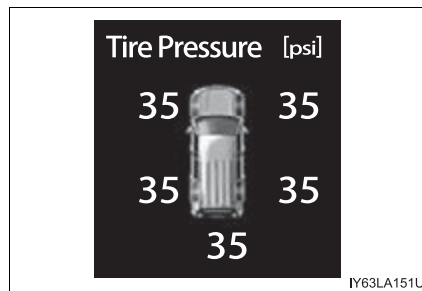

◆ Installing tire pressure warning valves and transmitters

When replacing tires or wheels, tire pressure warning valves and transmitters must also be installed.

When new tire pressure warning valves and transmitters are installed, new ID codes must be registered in the tire pressure warning computer and the tire pressure warning system must be initialized. Have tire pressure warning valve and transmitter ID codes registered by your Toyota dealer.

◆ Initializing the tire pressure warning system

■ The tire pressure warning system must be initialized in the following circumstances:

- When rotating the tires.

When the tire pressure warning system is initialized, the current tire inflation pressure is set as the pressure benchmark.

■ How to initialize the tire pressure warning system

- 1 Park the vehicle in safe place and turn the engine switch to OFF.

Initialization cannot be performed while the vehicle is moved.

- 2 Adjust the tire inflation pressure to the specified cold tire inflation pressure level. (→P. 558)

Make sure to adjust the tire pressure to the specified cold tire inflation pressure level. The tire pressure warning system will operate based on this pressure level.

- 3 Turn the engine switch to IGNITION ON mode.

- 4 Press and hold the tire pressure warning reset switch until the tire pressure warning light blinks slowly 3 times.

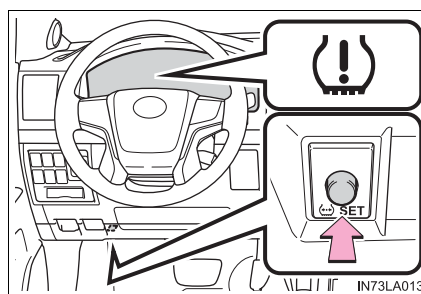

"--" will be displayed for inflation pressure of each tire on the multi-information display while the tire pressure warning system determines the position on the multi-information display.

When position of each tire is determined, the inflation pressure of each tire will be displayed on the multi-information display.

- 5 Drive the vehicle at approximately 25mph (40 km/h) or more for approximately 10 minutes.

When initialization is complete, the inflation pressure of each tire will be displayed on the multi-information display.

Initialization will take longer than approximately 10 minutes if the vehicle is stopped for a long time, such as at traffic signals.

◆ Registering ID codes

The tire pressure warning valve and transmitter is equipped with a unique ID code. When replacing a tire pressure warning valve and transmitter, it is necessary to register the ID code. Have the ID code registered by your Toyota dealer.

■ **When to replace your vehicle's tires**

Tires should be replaced if:

- The treadwear indicators are showing on a tire.
- You have tire damage such as cuts, splits, cracks deep enough to expose the fabric, and bulges indicating internal damage
- A tire goes flat repeatedly or cannot be properly repaired due to the size or location of a cut or other damage

If you are not sure, consult with your Toyota dealer.

■ **Replacing tires and wheels**

If the ID code of the tire pressure warning valve and transmitter is not registered, the tire pressure warning system will not work properly. After driving for about 20 minutes, the tire pressure warning light blinks for 1 minute and stays on to indicate a system malfunction.

■ **Tire life**

Any tire over 6 years old must be checked by a qualified technician even if it has seldom or never been used or damage is not obvious.

■ **Routine tire inflation pressure checks**

The tire pressure warning system does not replace routine tire inflation pressure checks. Make sure to check tire inflation pressure as part of your routine of daily vehicle checks.

■ **Maximum load of tire**

Check that the number given by dividing the maximum load by 1.10 of the replacement tire is greater than 1/2 of the Gross Axle Weight Ratings (GAWR) of either the front axle or the rear axle, whichever is greater.

For the GAWR, see the Certification Label. For the maximum load of the tire, see the load limit at maximum cold tire inflation pressure mentioned on the sidewall of the tire. (→P. 563)

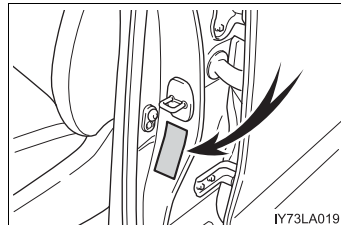

■ Tire types**● Summer tires**

Summer tires are high-speed performance tires best suited to highway driving under dry conditions. Since summer tires do not have the same traction performance as snow tires, summer tires are inadequate for driving on snow-covered or icy roads. For driving on snow-covered roads or icy roads, the use of snow tires is recommended. When installing snow tires, be sure to replace all four tires.

● All season tires

All season tires are designed to provide better traction in snow and to be adequate for driving in most winter conditions as well as for use year-round. All season tires, however, do not have adequate traction performance compared with snow tires in heavy or loose snow. Also, all season tires fall short in acceleration and handling performance compared with summer tires in highway driving.

● Snow tires

For driving on snow-covered roads or icy roads, we recommend using snow tires. If you need snow tires, select tires of the same size, construction and load capacity as the originally installed tires. Since your vehicle has radial tires as original equipment, make sure your snow tires also have radial construction. Do not install studded tires without first checking local regulations for possible restrictions. Snow tires should be installed on all wheels. (→P. 369)

■ When rotating the tires

Make sure that the engine switch is off. If the tires are rotated while the engine switch is in IGNITION ON mode, the tire position information will not be updated.

If this accidentally occurs, either turn the engine switch to off and then to IGNITION ON mode, or initialize the system after checking that the tire pressure is properly adjusted.

■ **If the tread on snow tires wears down below 0.16 in. (4 mm)**

The effectiveness of the tires as snow tires is lost.

■ **Initializing the tire pressure warning system**

initialize the system with the tire inflation pressure adjusted to the specified level.

■ **Situations in which the tire pressure warning system may not operate properly**

- In the following cases, the tire pressure warning system may not operate properly.
 - If non-genuine Toyota wheels are used.
 - A tire has been replaced with a tire that is not an OE (Original Equipment) tire.
 - A tire has been replaced with a tire that is not of the specified size.
 - Tire chains etc. are equipped.
 - An auxiliary-supported run-flat tire is equipped.
 - If a window tint that affects the radio wave signals is installed.
 - If there is a lot of snow or ice on the vehicle, particularly around the wheels or wheel housings.
 - If the spare tire is in a location subject to poor radio wave signal reception.
 - If a large metallic object which can interfere with signal reception is put near the spare tire.
 - If tires not equipped with the tire pressure warning valves and transmitters are used.
 - If the ID code on the tire pressure warning valves and transmitters is not registered in the tire pressure warning computer.
- Performance may be affected in the following situations.
 - Near a TV tower, electric power plant, gas station, radio station, large display, airport or other facility that generates strong radio waves or electrical noise
 - When carrying a portable radio, cellular phone, cordless phone or other wireless communication device
- When the vehicle is parked, the time taken for the warning to start or go off could be extended.
- When tire inflation pressure declines rapidly for example when a tire has burst, the warning may not function.

■ The initialization operation

- Make sure to carry out initialization after adjusting the tire inflation pressure. Also, make sure the tires are cold before carrying out initialization or tire inflation pressure adjustment.
- If you have accidentally turned the engine switch off during initialization, it is not necessary to press the reset switch again as initialization will restart automatically when the engine switch has been turned to IGNITION ON mode for the next time.
- If you accidentally press the reset switch when initialization is not necessary, adjust the tire inflation pressure to the specified level when the tires are cold, and conduct initialization again.
- While the position of each tire is being determined and the inflation pressures are not being displayed on the multi-information display, if the inflation pressure of a tire drops, the tire pressure warning light will come on.

■ Warning performance of the tire pressure warning system

The warning of the tire pressure warning system will change in accordance with the conditions under which it was initialized. For this reason, the system may give a warning even if the tire pressure does not reach a low enough level, or if the pressure is higher than the pressure that was adjusted to when the system was initialized.

■ When initialization of the tire pressure warning system has failed

Initialization may take longer to complete if the vehicle is driven on an unpaved road. When performing initialization, drive on a paved road if possible. Depending on the driving environment and condition of the tires, initialization will be completed in approximately 10 minutes. If initialization is not complete after driving approximately 10 minutes, continue driving for a while.

If the inflation of each tire is not displayed after driving for approximately 1 hour, perform the following procedure.

- Park the vehicle in a safe place for approximately 20 minutes. Then drive straight (with occasional left and right turns) at approximately 25 mph (40 km/h) or more for approximately 10 to 20 minutes.

However, in the following situations, the tire inflation pressure will not be recorded and the system will not operate properly. Perform initialization.

- When operating the tire pressure warning reset switch, the tire pressure warning light does not blink 3 times.
- After performing initialization, the tire pressure warning light blinks for 1 minute then stays on after driving for about 20 minutes.

If the inflation pressure of each tire is still not displayed, have the vehicle inspected by your Toyota dealer.

■ **Tire pressure warning system certification**

FCC ID: PAXPMVC015

NOTE

This device complies with part 15 of the FCC Rules. Operation is subject to the following two conditions:
(1) This device may not cause harmful interference, and (2) this device must accept any interference received, including interference that may cause undesired operation.

FCC WARNING

Changes or modifications not expressly approved by the party responsible for compliance could void the user's authority to operate the equipment.

 **WARNING**

■ **Tire pressure warning system operation**

The tire pressure warning system may not provide warning immediately if a tire bursts or if sudden air leakage occurs.

■ **When inspecting or replacing tires**

Observe the following precautions to prevent accidents. Failure to do so may cause damage to parts of the drive train as well as dangerous handling characteristics, which may lead to an accident resulting in death or serious injury.

- Do not mix tires of different makes, models or tread patterns. Also, do not mix tires of remarkably different treadwear.
- Do not use tire sizes other than those recommended by Toyota.
- Do not mix differently constructed tires (radial, bias-belted or bias-ply tires).
- Do not mix summer, all season and snow tires.
- Do not use tires that have been used on another vehicle. Do not use tires if you do not know how they were used previously.

■ **When initializing the tire pressure warning system**

Do not operate the tire pressure warning reset switch without first adjusting the tire inflation pressure to the specified level. Otherwise, the tire pressure warning light may not come on even if the tire inflation pressure is low, or it may come on when the tire inflation pressure is actually normal.

 NOTICE**■ Repairing or replacing tires, wheels, tire pressure warning valves, transmitters and tire valve caps**

- When removing or fitting the wheels, tires or the tire pressure warning valves and transmitters, contact your Toyota dealer as the tire pressure warning valves and transmitters may be damaged if not handled correctly.
- Make sure to install the tire valve caps. If the tire valve caps are not installed, water could enter the tire pressure warning valves and the tire pressure warning valves could be bound.
- When replacing tire valve caps, do not use tire valve caps other than those specified. The cap may become stuck.

■ To avoid damage to the tire pressure warning valves and transmitters

When a tire is repaired with liquid sealants, the tire pressure warning valve and transmitter may not operate properly. If a liquid sealant is used, contact your Toyota dealer or other qualified service shop as soon as possible. Make sure to replace the tire pressure warning valve and transmitter when replacing the tire. (→P. 464)

■ Driving on rough roads

Take particular care when driving on roads with loose surfaces or potholes.

These conditions may cause losses in tire inflation pressure, reducing the cushioning ability of the tires. In addition, driving on rough roads may cause damage to the tires themselves, as well as the vehicle's wheels and body.

■ If tire inflation pressure of each tire becomes low while driving

Do not continue driving, or your tires and/or wheels may be ruined.

Tire inflation pressure

Tire inflation pressure

The recommended cold tire inflation pressure and tire size are displayed on the tire and loading information label. (→P. 558)

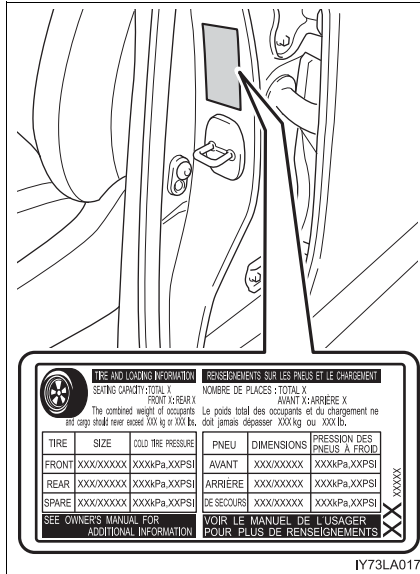

Inspection and adjustment procedure

- ① Tire valve
- ② Tire pressure gauge

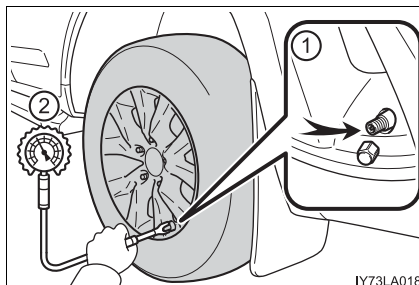

- 1 Remove the tire valve cap.
- 2 Press the tip of the tire pressure gauge onto the tire valve.
- 3 Read the pressure using the gauge gradations.
- 4 If the tire inflation pressure is not at the recommended level, adjust the pressure.
If you add too much air, press the center of the valve to deflate.
- 5 After completing the tire inflation pressure measurement and adjustment, apply soapy water to the valve and check for leakage.
- 6 Put the tire valve cap back on.

■ Tire inflation pressure check interval

You should check tire inflation pressure every two weeks, or at least once a month. Do not forget to check the spare.

■ Effects of incorrect tire inflation pressure

Driving with incorrect tire inflation pressure may result in the following:

- Reduced fuel economy
- Reduced driving comfort and poor handling
- Reduced tire life due to wear
- Reduced safety
- Damage to the drive train

If a tire needs frequent inflating, have it checked by your Toyota dealer.

■ Instructions for checking tire inflation pressure

When checking tire inflation pressure, observe the following:

- Check only when the tires are cold.
If your vehicle has been parked for at least 3 hours and has not been driven for more than 1 mile or 1.5 km, you will get an accurate cold tire inflation pressure reading.
- Always use a tire pressure gauge.
It is difficult to judge if a tire is properly inflated based only on its appearance.
- It is normal for the tire inflation pressure to be higher after driving as heat is generated in the tire. Do not reduce tire inflation pressure after driving.
- Never exceed the vehicle capacity weight.
Passengers and luggage weight should be placed so that the vehicle is balanced.

⚠ WARNING**■ Proper inflation is critical to save tire performance**

Keep your tires properly inflated.

If the tires are not properly inflated, the following conditions may occur which could lead to an accident resulting in death or serious injury:

- Excessive wear
- Uneven wear
- Poor handling
- Possibility of blowouts resulting from overheated tires
- Air leaking from between tire and wheel
- Wheel deformation and/ or tire damage
- Greater possibility of tire damage while driving (due to road hazards, expansion joints, sharp edges in the road, etc.)

⚠ NOTICE**■ When inspecting and adjusting tire inflation pressure**

Be sure to put the tire valve caps back on.

If a valve cap is not installed, dirt or moisture may get into the valve and cause an air leak, resulting in decreased tire inflation pressure.

Wheels

If a wheel is bent, cracked or heavily corroded, it should be replaced.

Otherwise, the tire may separate from the wheel or cause loss of handling control.

Wheel selection

When replacing wheels, care should be taken to ensure that they are equivalent to those removed in load capacity, diameter, rim width, and inset*.

Replacement wheels are available at your Toyota dealer.

*: Conventionally referred to as "offset".

Toyota does not recommend using the following:

- Wheels of different sizes or types
- Used wheels
- Bent wheels that have been straightened

Aluminum wheel precautions

- Use only Toyota wheel nuts and wrenches designed for use with your aluminum wheels.
- When rotating, repairing or changing your tires, check that the wheel nuts are still tight after driving 1000 miles (1600 km).
- Be careful not to damage the aluminum wheels when using tire chains.
- Use only Toyota genuine balance weights or equivalent and a plastic or rubber hammer when balancing your wheels.

When replacing wheels

The wheels of your vehicle are equipped with tire pressure warning valves and transmitters that allow the tire pressure warning system to provide advance warning in the event of a loss in tire inflation pressure. Whenever wheels are replaced, tire pressure warning valves and transmitters must be installed. (→P. 464)

⚠ WARNING**■ When replacing wheels**

- Do not use wheels that are a different size from those recommended in the Owner's Manual, as this may result in a loss of handling control.
- Never use an inner tube in a leaking wheel which is designed for a tubeless tire. Doing so may result in an accident, causing death or serious injury.

■ When installing the wheel nuts

- Be sure to install the wheel nuts with the tapered ends facing inward. Installing the nuts with the tapered ends facing outward can cause the wheel to break and eventually cause the wheel to come off while driving, which could lead to an accident resulting in death or serious injury.

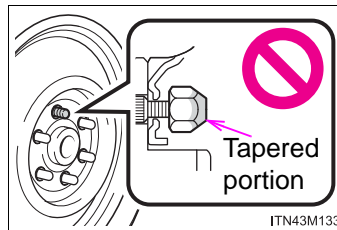

- Never use oil or grease on the wheel bolts or wheel nuts. Oil and grease may cause the wheel nuts to be excessively tightened, leading to bolt or disc wheel damage. In addition, the oil or grease can cause the wheel nuts to loosen and the wheel may fall off, causing an accident and resulting in death or serious injury. Remove any oil or grease from the wheel bolts or wheel nuts.

■ Use of defective wheels prohibited

Do not use cracked or deformed wheels. Doing so could cause the tire to leak air during driving, possibly causing an accident.

⚠ NOTICE**■ Replacing tire pressure warning valves and transmitters**

- Because tire repair or replacement may affect the tire pressure warning valves and transmitters, make sure to have tires serviced by your Toyota dealer or other qualified service shop. In addition, make sure to purchase your tire pressure warning valves and transmitters at your Toyota dealer.
- Ensure that only genuine Toyota wheels are used on your vehicle. Tire pressure warning valves and transmitters may not work properly with non-genuine wheels.

Air conditioning filter

The air conditioning filter must be cleaned or changed regularly to maintain air conditioning efficiency.

Removal method

- 1 Turn the engine switch IGNITION ON mode and switch to recirculated air mode, then turn the engine switch off.
- 2 Open the glove box and remove the separate tray. (→P. 397)
- 3 Remove the filter cover.

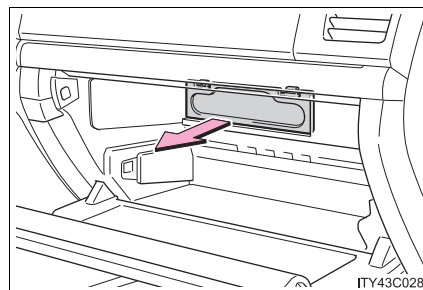

- 4 Remove the filter case.

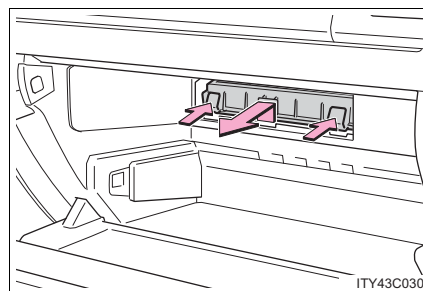

Cleaning method

If the filter is dirty, clean by blowing compressed air through the filter from the downward side.

Hold the air gun 2 in. (5 cm) from the filter and blow for approximately 2 minutes at 72 psi (500 kPa, 5.0 kgf/cm² or bar).

If it is not available, have the filter cleaned by your Toyota dealer.

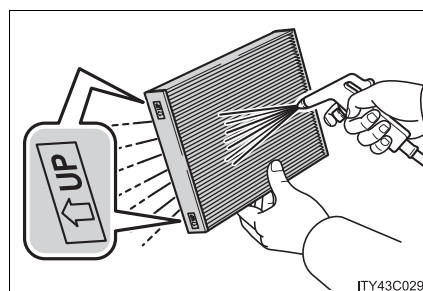

Replacement method

Remove the air conditioning filter and replace it with a new one.

The “↑UP” marks shown on the filter should be pointing up.

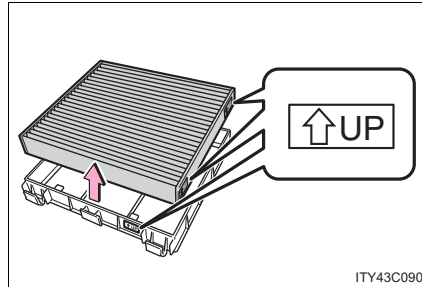

■ Checking interval

Inspect, clean and replace the air conditioning filter according to the maintenance schedule. In dusty areas or areas with heavy traffic flow, more frequent cleaning or early replacement may be required.

(For scheduled maintenance information, please refer to the “Owner’s Manual Supplement” or “Scheduled Maintenance”.)

■ If air flow from the vents decreases dramatically

The filter may be clogged. Check the filter and replace if necessary.

⚠ NOTICE

■ To prevent damage to the system

- When using the air conditioning system, make sure that a filter is always installed.
- When cleaning the filter, do not clean the filter with water.

Electronic key battery

Replace the battery with a new one if it is depleted.

You will need the following items:

- Flathead screwdriver
- Small Phillips-head screwdriver
- Lithium battery (CR2032)

Replacing the battery

- 1 Take out the mechanical key.

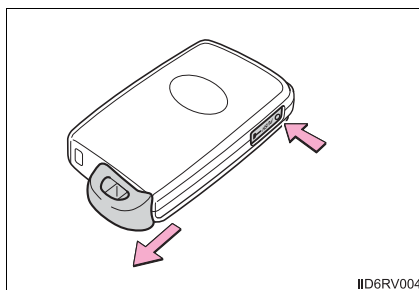

- 2 Remove the cover.

To prevent damage to the key, cover the tip of the screwdriver with a rag.

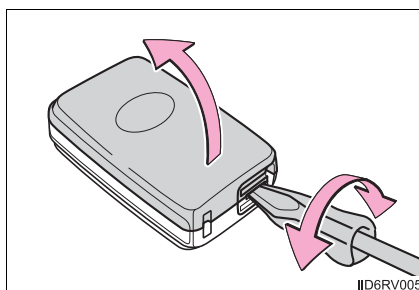

- 3 Remove the depleted battery.

When removing the cover, if the battery cannot be seen due to the electronic key module attaching to the upper cover, remove the electronic key module from the cover so that the battery is visible as shown in the illustration.

Insert a new battery with the "+" terminal facing up.

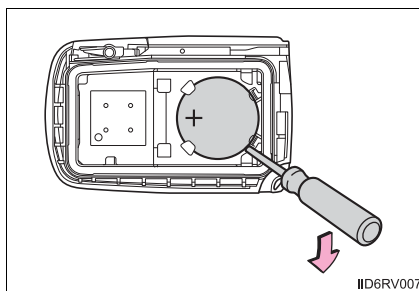

■ **Use a CR2032 lithium battery**

- Batteries can be purchased at your Toyota dealer, local electrical appliance shops or camera stores.
- Replace only with the same or equivalent type recommended by the manufacturer.
- Dispose of used batteries according to the local laws.

■ **If the electronic key battery is depleted**

The following symptoms may occur:

- The smart key system and wireless remote control will not function properly.
- The operational range will be reduced.

 **WARNING**

■ **Removed battery and other parts**

These parts are small and if swallowed by a child, they can cause choking. Keep away from children. Failure to do so could result in death or serious injury.

 **NOTICE**

■ **For normal operation after replacing the battery**

Observe the following precautions to prevent accidents:

- Always work with dry hands.
Moisture may cause the battery to rust.
- Do not touch or move any other component inside the remote control.
- Do not bend either of the battery terminals.

Checking and replacing fuses

If any of the electrical components do not operate, a fuse may have blown. If this happens, check and replace the fuses as necessary.

1 Turn the engine switch off.

2 Open the fuse box cover.

▶ Engine compartment

Push the tab in and lift the lid off.

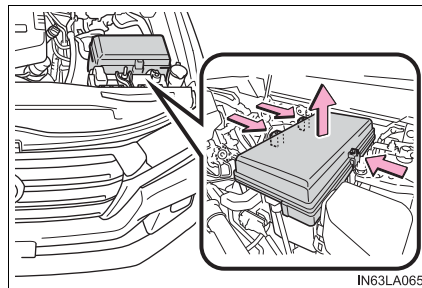

▶ Driver's side instrument panel

Remove the lid.

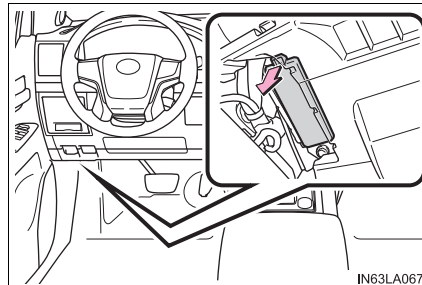

► Passenger's side instrument panel

① Remove the cover.

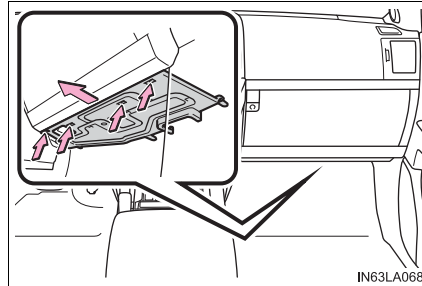

② Remove the lid.

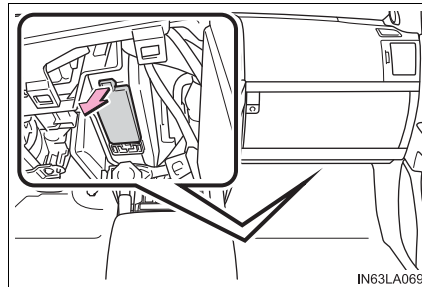

③ Remove the fuse with the pull-out tool.

Only type A fuse can be removed using the pull-out tool.

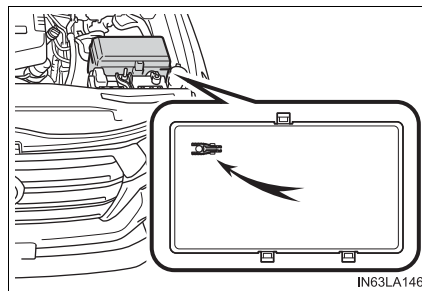

4 Check if the fuse is blown.

- ① Normal fuse
- ② Blown fuse

Type A and B:

Replace the blown fuse with a new fuse of an appropriate amperage rating. The amperage rating can be found on the fuse box lid.

Type C and D:

Contact your Toyota dealer.

▶ Type A

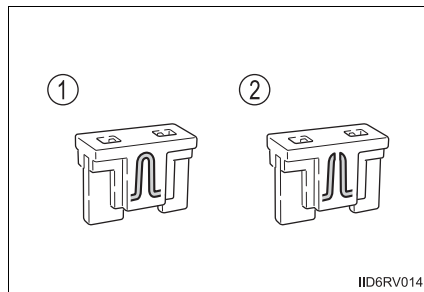

▶ Type B

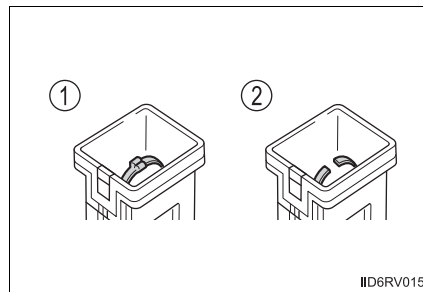

▶ Type C

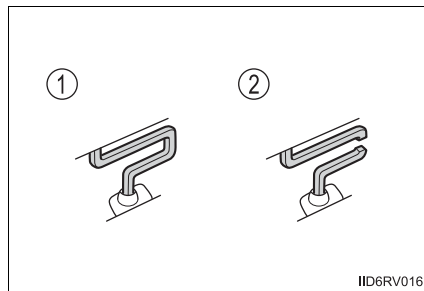

▶ Type D

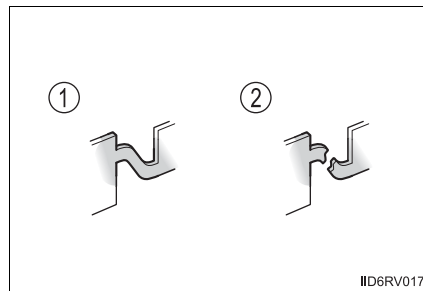

■ After a fuse is replaced

- If the lights do not turn on even after the fuse has been replaced, a bulb may need replacement. (→P. 487)
- If the replaced fuse blows again, have the vehicle inspected by your Toyota dealer.

■ If there is an overload in a circuit

The fuses are designed to blow, protecting the wiring harness from damage.

■ When replacing light bulbs

Toyota recommends that you use genuine Toyota products designed for this vehicle. Because certain bulbs are connected to circuits designed to prevent overload, non-genuine parts or parts not designed for this vehicle may be unusable.

 **WARNING****■ To prevent system breakdowns and vehicle fire**

Observe the following precautions.

Failure to do so may cause damage to the vehicle, and possibly a fire or injury.

- Never use a fuse of a higher amperage rating than indicated, or use any other object in place of a fuse.
- Always use a genuine Toyota fuse or equivalent.
Never replace a fuse with a wire, even as a temporary fix.
- Do not modify the fuses or the fuse boxes.

 **NOTICE****■ Before replacing fuses**

Have the cause of electrical overload determined and repaired by your Toyota dealer, as soon as possible.

Headlight aim

Vertical movement adjusting bolts

- ① Adjustment bolt A
(Vertical adjustment)
- ② Adjustment bolt B
(Horizontal adjustment)

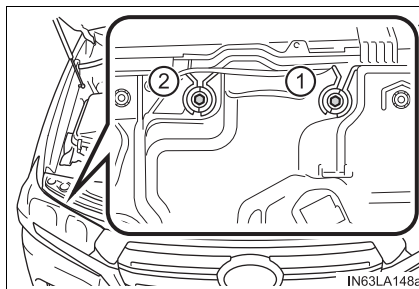

Before checking the headlight aim

- 1 Make sure the vehicle has a full tank of gasoline and the area around the headlight is not deformed.
- 2 Park the vehicle on level ground.
- 3 Sit in the driver's seat.
- 4 Bounce the vehicle several times.

Adjusting the headlight aim

- 1 Using a Phillips-head screwdriver, turn bolt A in either direction.

Remember the turning direction and the number of turns.

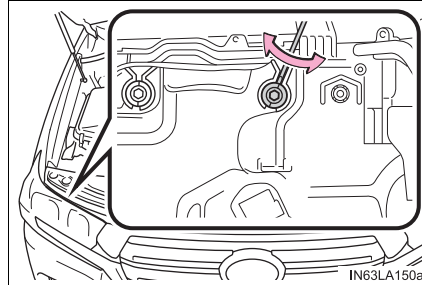

- 2 Turn bolt B the same number of turns and in the same direction as step 1.

If the headlight cannot be adjusted using this procedure, take the vehicle to your Toyota dealer to adjust the headlight aim.

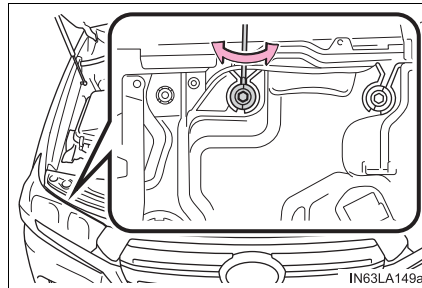

Light bulbs

You may replace the following bulbs yourself. The difficulty level of replacement varies depending on the bulb. If necessary bulb replacement seems difficult to perform, contact your Toyota dealer.

For more information about replacing other light bulbs, contact your Toyota dealer.

Preparing for light bulb replacement

Check the wattage and color of the light bulb being replaced.
(→P. 559)

Removing the engine compartment covers

→P. 451

Bulb locations

■ Front

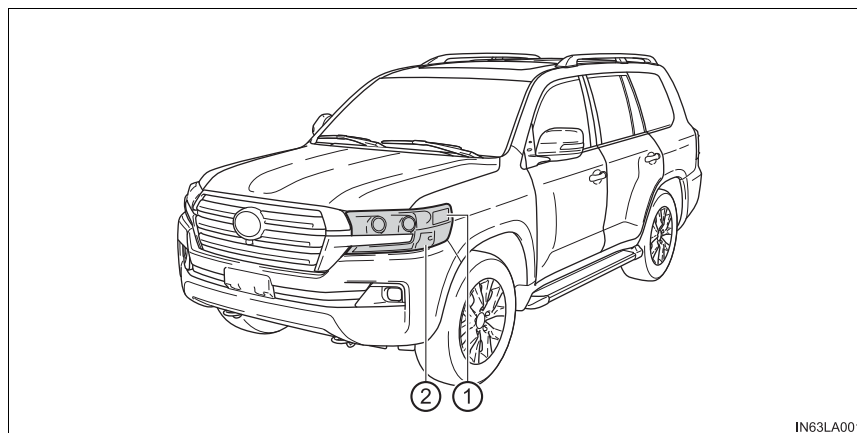

- ① Front side marker light
- ② Front turn signal light

■ Rear

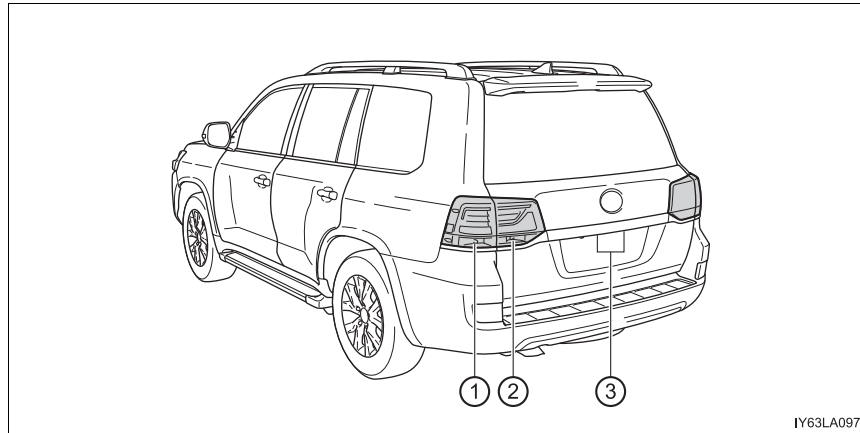

- ① Rear turn signal light
- ② Back-up light

- ③ License plate lights

IY63LA097

Replacing light bulbs**■ Front side marker light**

- 1 For the left side only:
Remove the securing clip and move the washer fluid filler opening.

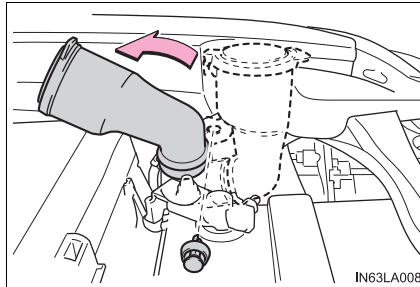

- 2 Turn the bulb base counter-clockwise.

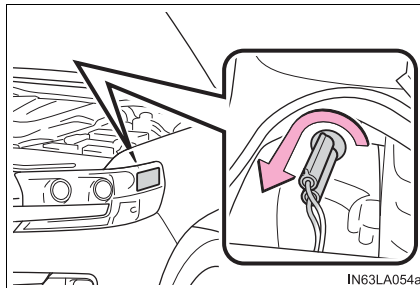

- 3 Remove the light bulb.

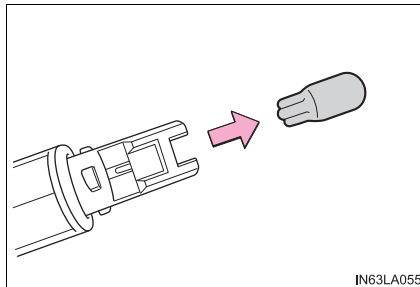

- 4 When installing, reverse the steps listed.

■ **Front turn signal lights**

- 1 For the left side only:
Remove the securing clip and move the washer fluid filler opening.

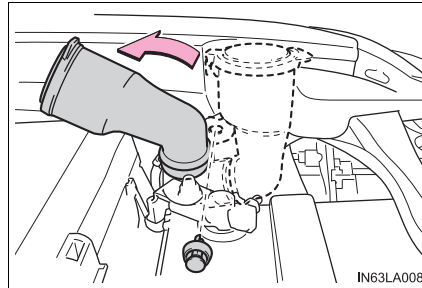

- 2 To allow enough working space, remove the bulb base of the front side marker light.
Wrap the removed bulb base with cloth to prevent damage to the bulb base.

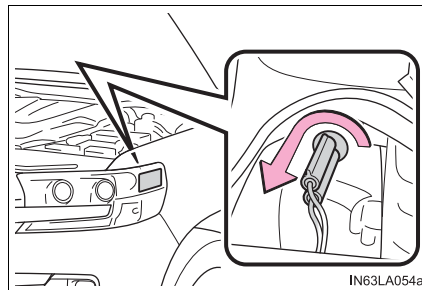

- 3 Unplug the connector while depressing the lock release.

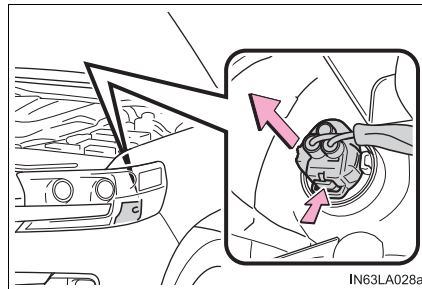

- 4 Turn the bulb base counter-clockwise.

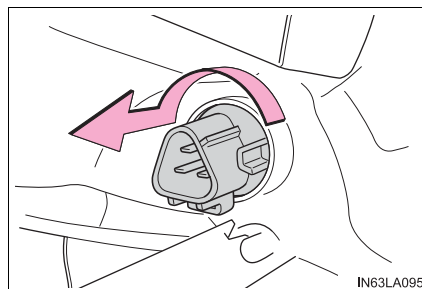

- 5 Remove the light bulb.

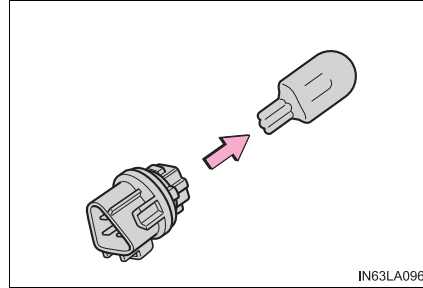

- 6 When installing, reverse the steps listed.

■ **Back-up light**

- 1 Open the back door and remove the nuts and lamp assembly.

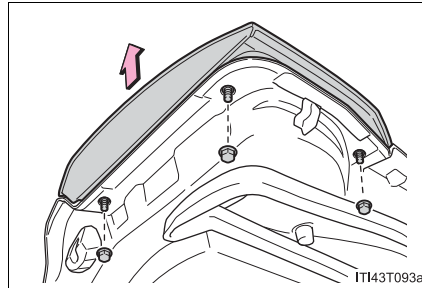

- 2 Unplug the connector while pressing the lock release.

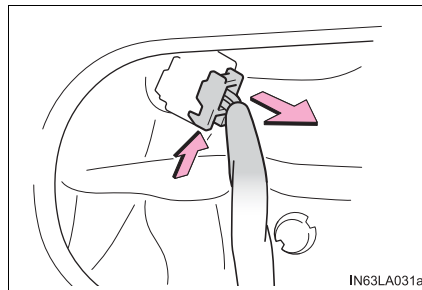

- 3 Remove the cover.

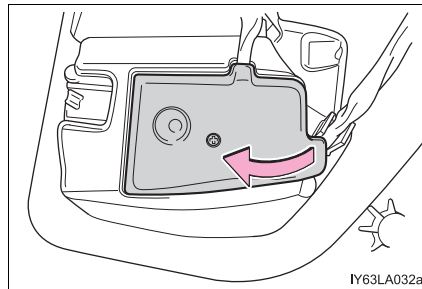

- 4 Unclip the connector wire and turn the bulb bases counterclockwise.

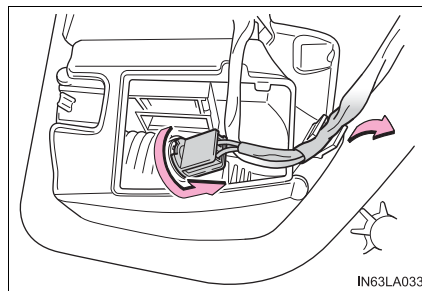

- 5 Remove the light bulb.

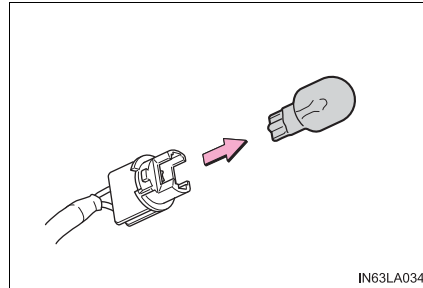

- 6 When installing, reverse the steps listed.

■ **Rear turn signal lights**

- 1 Open the back door and attach protective tape under the light unit. (Use masking tape. Do not use any duct tape, as duct tape may leave markings.)

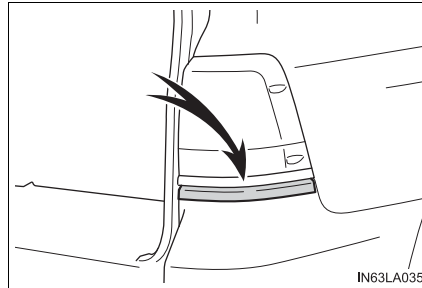

- 2 Remove the cover.

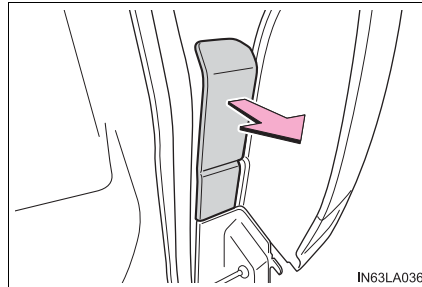

- 3 Remove the 2 bolts and lamp assembly.

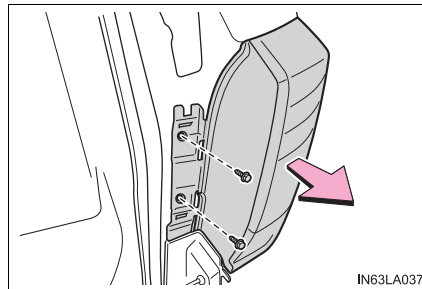

- 4 Unplug the connector while pressing the lock release.

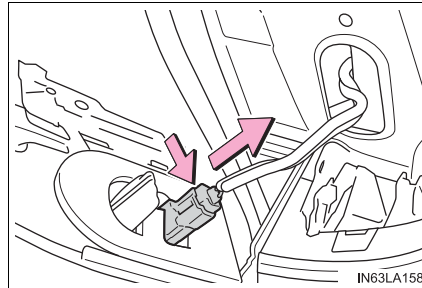

- 5 Turn the bulb bases counter-clockwise.

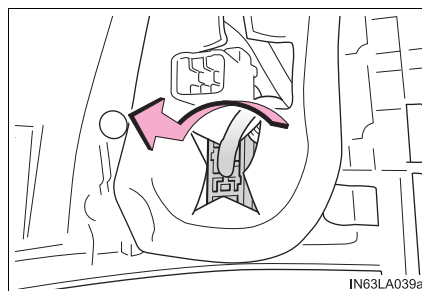

- 6 Remove the light bulb.

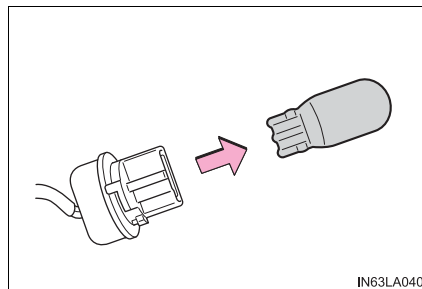

- 7 When installing, reverse the steps listed.

■ License plate light

- 1 Open the back door and remove the license plate light unit.

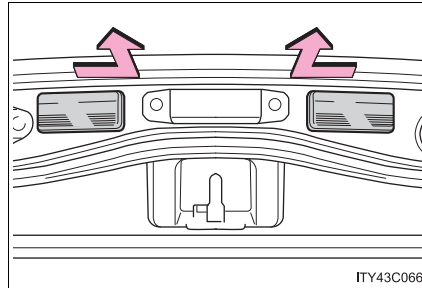

- 2 Turn the bulb base counter-clockwise.

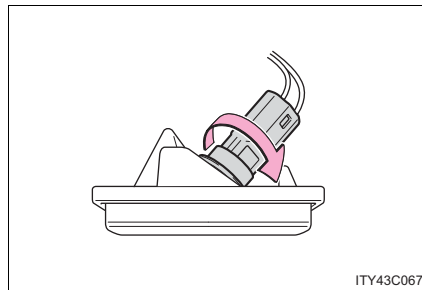

- 3 Remove the light bulb.

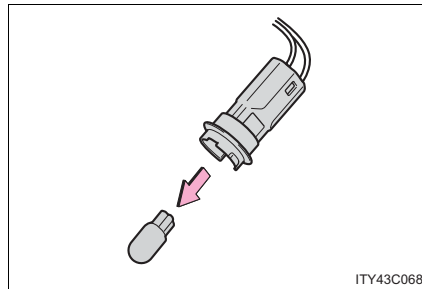

- 4 When installing, reverse the steps listed.

■ Replacing the following bulbs

If any of the lights listed below has burnt out, have it replaced by your Toyota dealer.

- Headlights/daytime running lights
- Parking lights
- Fog lights
- Side turn signal lights
- High mounted stoplight
- Stop/tail lights
- Stop lights
- Rear side marker lights

■ LED lights

The headlights/daytime running lights, parking lights, fog lights, side turn signal lights, high mounted stoplight, stop/tail lights, stop lights and rear side marker lights consist of a number of LEDs. If any of the LEDs burn out, take your vehicle to your Toyota dealer to have the light replaced.

■ Condensation build-up on the inside of the lens

Temporary condensation build-up on the inside of the headlight lens does not indicate a malfunction. Contact your Toyota dealer for more information in the following situations:

- Large drops of water are built up on the inside of the lens.
- Water has built up inside the headlight.

■ When replacing light bulbs

→P. 484

**WARNING****■ Replacing light bulbs**

- Turn off the headlights. Do not attempt to replace the bulb immediately after turning off the headlights.
The bulbs become very hot and may cause burns.
- Do not touch the glass portion of the light bulb with bare hands. When it is unavoidable to hold the glass portion, use and hold with a clean dry cloth to avoid getting moisture and oils on the bulb.
Also, if the bulb is scratched or dropped, it may blow out or crack.
- Fully install light bulbs and any parts used to secure them. Failure to do so may result in heat damage, fire, or water entering the headlight unit. This may damage the headlights or cause condensation to build up on the lens.
- Do not attempt to repair or disassemble light bulbs, connectors, electric circuits or component parts.
Doing so may result in death or serious injury due to electric shock.

■ To prevent damage or fire

- Make sure bulbs are fully seated and locked.
- Check the wattage of the bulb before installing to prevent heat damage.

When trouble arises

7

7-1. Essential information

- Emergency flashers 500
- If your vehicle has to be stopped in an emergency 501

7-2. Steps to take in an emergency

- If your vehicle needs to be towed 502
- If you think something is wrong 508
- Fuel pump shut off system 509
- If a warning light turns on or a warning buzzer sounds 510
- If a warning message is displayed..... 519
- If you have a flat tire..... 524
- If the engine will not start .. 537
- If the shift lever cannot be shifted from P..... 539
- If the electronic key does not operate properly..... 540
- If the vehicle battery is discharged 543
- If your vehicle overheats ... 546
- If the vehicle becomes stuck 549

Emergency flashers

The emergency flashers are used to warn other drivers when the vehicle has to be stopped in the road due to a breakdown, etc.

Press the switch.

All the turn signal lights will flash.
To turn them off, press the switch
once again.

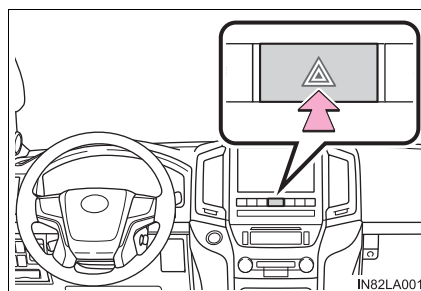

■ Emergency flashers

If the emergency flashers are used for a long time while the engine is not operating, the battery may discharge.

If your vehicle has to be stopped in an emergency

Only in an emergency, such as if it becomes impossible to stop the vehicle in the normal way, stop the vehicle using the following procedure:

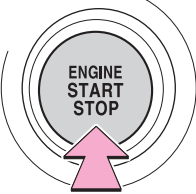
- 1 Steadily step on the brake pedal with both feet and firmly depress it.
Do not pump the brake pedal repeatedly as this will increase the effort required to slow the vehicle.
 - 2 Shift the shift lever to N.
 - ▶ If the shift lever is shifted to N
 - 3 After slowing down, stop the vehicle in a safe place by the road.
 - 4 Stop the engine.
 - ▶ If the shift lever cannot be shifted to N
 - 3 Keep depressing the brake pedal with both feet to reduce vehicle speed as much as possible.
 - 4 To stop the engine, press and hold the engine switch for 2 consecutive seconds or more, or press it briefly 3 times or more in succession.
- 

Press and hold for 2 seconds or more, or press briefly 3 times or more

IN82LA124
- 5 Stop the vehicle in a safe place by the road.

WARNING

■ If the engine has to be turned off while driving

Power assist for the brakes and steering wheel will be lost, making the brake pedal harder to depress and the steering wheel heavier to turn. Decelerate as much as possible before turning off the engine.

If your vehicle needs to be towed

If towing is necessary, we recommend having your vehicle towed by your Toyota dealer or commercial towing service, using a wheel-lift type truck or flatbed truck.

Use a safety chain system for all towing, and abide by all state/provincial and local laws.

Situations when it is necessary to contact dealers before towing

The following may indicate a problem with your transmission. Contact your Toyota dealer or commercial towing service before towing.

- The engine is running but the vehicle does not move.
- The vehicle makes an abnormal sound.

Towing with a sling-type truck

Do not tow with a sling-type truck to prevent body damage.

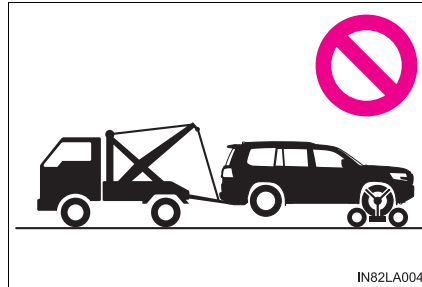

Towing with a wheel-lift type truck

► From the front

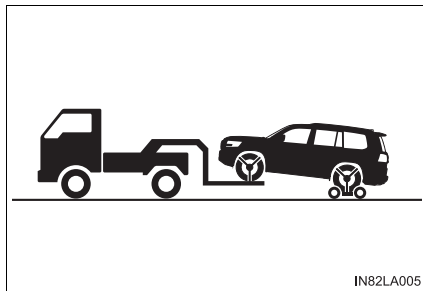

Use a towing dolly under the rear wheels.

► From the rear

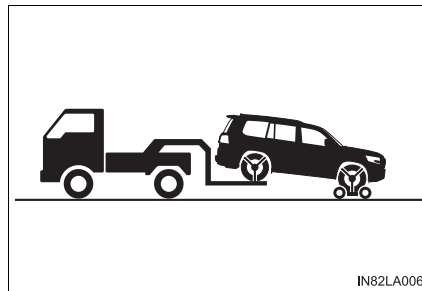

Use a towing dolly under the front wheels.

Using a flatbed truck

If your vehicle is transported by a flatbed truck, it should be tied down at the locations shown in the illustration.

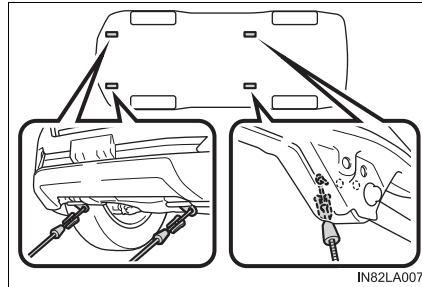

If you use chains or cables to tie down your vehicle, the angles shaded in black must be 45°.

Do not overly tighten the tie downs or the vehicle may be damaged.

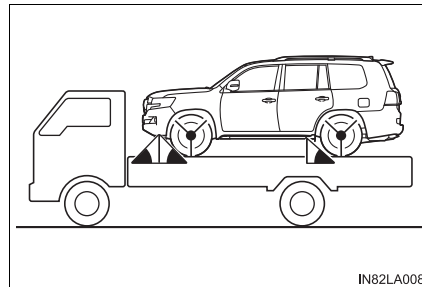

Emergency towing

If a tow truck is not available in an emergency, your vehicle may be temporarily towed using cables or chains secured to the emergency towing hooks. This should only be attempted on hard surfaced roads for at most 50 miles (80 km) at under 18 mph (30 km/h).

A driver must be in the vehicle to steer and operate the brakes. The vehicle's wheels, drive train, axles, steering and brakes must be in good condition.

Emergency towing procedure

- 1 Securely attach cables or chains to the towing hooks.

Take care not to damage the vehicle body.

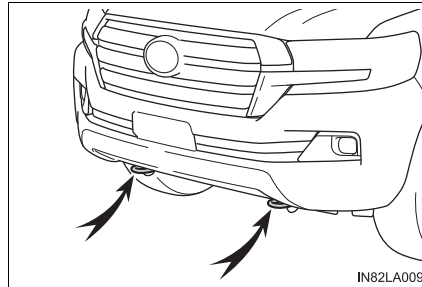

- 2 Enter the vehicle being towed and start the engine.
If the engine does not start, turn the engine switch to IGNITION ON mode.
- 3 Put the four-wheel drive control switch in "H4". (The center differential is unlocked.)
- 4 Shift the shift lever to N and release the parking brake.
When the shift lever cannot be shifted: →P. 539

■ While towing

If the engine is not running, the power assist for the brakes and steering will not function, making steering and braking more difficult.

⚠ WARNING

Observe the following precautions.
Failure to do so may result in death or serious injury.

■ **When towing the vehicle**

Be sure to transport the vehicle with all four wheels raised off the ground. If the vehicle is towed with the tires contacting the ground, the drivetrain or related parts may be damaged, the vehicle may fly off the truck.

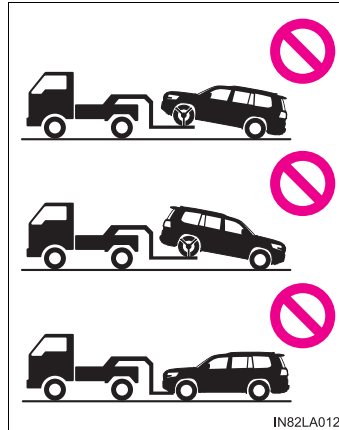

■ **While towing**

- When towing using cables or chains, avoid sudden starts, etc. which place excessive stress on the towing hooks, cables or chains. The towing hooks, cables or chains may become damaged, broken debris may hit people and cause serious damage.
- Do not turn the engine switch off.
There is a possibility that the steering wheel is locked and cannot be operated.

 NOTICE**■ To prevent damage to the vehicle when towing using a wheel-lift type truck**

- Do not tow the vehicle from the rear when the engine switch is off. The steering lock mechanism is not strong enough to hold the front wheels straight.
- When raising the vehicle, ensure adequate ground clearance for towing at the opposite end of the raised vehicle. Without adequate clearance, the vehicle could be damaged while being towed.

■ To prevent damage to the vehicle when towing with a sling-type truck

Do not tow with a sling-type truck, either from the front or rear.

■ To prevent damage to the vehicle during emergency towing

Do not secure cables or chains to the suspension components.

■ To avoid serious damage to your vehicle

Do not use the rear emergency towing hook.

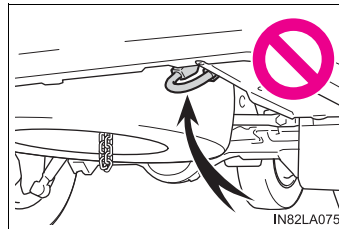

If you think something is wrong

If you notice any of the following symptoms, your vehicle probably needs adjustment or repair. Contact your Toyota dealer as soon as possible.

Visible symptoms

- Fluid leaks under the vehicle
(Water dripping from the air conditioning after use is normal.)
- Flat-looking tires or uneven tire wear
- Engine coolant temperature gauge needle continually points higher than normal
- Engine oil pressure gauge continually points lower than normal.
- Voltmeter continually points higher or lower than normal.

Audible symptoms

- Changes in exhaust sound
- Excessive tire squeal when cornering
- Strange noises related to the suspension system
- Pinging or other noises related to the engine

Operational symptoms

- Engine missing, stumbling or running roughly
- Appreciable loss of power
- Vehicle pulls heavily to one side when braking
- Vehicle pulls heavily to one side when driving on a level road
- Loss of brake effectiveness, spongy feeling, pedal almost touches the floor

Fuel pump shut off system

To minimize the risk of fuel leakage when the engine stalls or when an airbag inflates upon collision, the fuel pump shut off system stops the supply of fuel to the engine.

Follow the procedure below to restart the engine after the system is activated.

- 1 Turn the engine switch to ACCESSORY mode or turn it off.
- 2 Restart the engine.

 NOTICE

■ **Before starting the engine**





Inspect the ground under the vehicle.



If you find that fuel has leaked onto the ground, the fuel system has been damaged and is in need of repair. Do not restart the engine.







If a warning light turns on or a warning buzzer sounds

Calmly perform the following actions if any of the warning lights comes on or flashes. If a light comes on or flashes, but then goes off, this does not necessarily indicate a malfunction in the system. However, if this continues to occur, have the vehicle inspected by your Toyota dealer.

Warning light and warning buzzer list

Warning light	Warning light/Details/Actions
	<p>Brake system warning light (warning buzzer)*1 Indicates that:</p> <ul style="list-style-type: none"> • The brake fluid level is low; or • The brake system is malfunctioning. <p>→ Immediately stop the vehicle in a safe place and contact your Toyota dealer. Continuing to drive the vehicle may be dangerous.</p>
	<p>Charging system warning light Indicates a malfunction in the vehicle's charging system</p> <p>→ Immediately stop the vehicle in a safe place and contact your Toyota dealer.</p>
	<p>Malfunction indicator lamp Indicates a malfunction in:</p> <ul style="list-style-type: none"> • The emission control system; • The electronic engine control system; • The electronic throttle control system; or • The electronic automatic transmission control system <p>→ Have the vehicle inspected by your Toyota dealer immediately.</p>
	<p>SRS warning light Indicates a malfunction in:</p> <ul style="list-style-type: none"> • The SRS airbag system; • The front passenger occupant classification system; or • The seat belt pretensioner system <p>→ Have the vehicle inspected by your Toyota dealer immediately.</p>

Warning light	Warning light/Details/Actions
	<p>ABS warning light Indicates a malfunction in:</p> <ul style="list-style-type: none"> • The Multi Terrain ABS; or • The brake assist system <p>→ Have the vehicle inspected by your Toyota dealer immediately.</p>
	<p>Slip indicator Indicates a malfunction in: or</p> <ul style="list-style-type: none"> • The VSC (Vehicle Stability Control) system; • Trailer Sway Control; • Active TRAC (Traction Control) system; • The hill-start assist control system • The Multi-terrain Select (if equipped); or • The Crawl Control (if equipped); <p>The light will flash when any of the above systems other than the Multi-terrain Select are operating.</p> <p>→ Have the vehicle inspected by your Toyota dealer immediately.</p>
 <p>(if equipped)</p>	<p>PCS warning light When the warning light flashes (and a buzzer sounds): Indicates a malfunction in the PCS (Pre-Collision System) → Have the vehicle inspected by your Toyota dealer immediately.</p> <p>When the warning light flashes (and a buzzer does not sound): Indicates that the PCS (Pre-Collision System) is temporarily unavailable, possibly due to either of the following:</p> <ul style="list-style-type: none"> • An area around the radar sensor or camera sensor being dirty, fogged up or covered with condensation, ice, stickers, etc. <p>→ Clear the dirt, fog, condensation, ice, stickers, etc. (→P. 228)</p> <ul style="list-style-type: none"> • Radar sensor or camera sensor temperature being outside of its operational range <p>→ Wait for a while until the area around the radar sensor or camera sensor has cooled down sufficiently.</p> <p>When the warning light is illuminated: Either the VSC (Vehicle Stability Control) system or PCS (Pre-Collision System) is disabled or both are disabled.</p> <p>→ To enable the PCS, enable both the VSC system and PCS. (→P. 237, 359)</p>

Warning light	Warning light/Details/Actions
	Open door warning light (warning buzzer)*² Indicates that a door is not fully closed → Check that all the doors are closed.
	Driver's seat belt reminder light (warning buzzer)*³ Warns the driver to fasten his/her seat belt. → Fasten the seat belt.
	Front passenger's seat belt reminder light (warning buzzer)*³ Warns the front passenger to fasten his/her seat belt → Fasten the seat belt.
	Low fuel level warning light Indicates that remaining fuel is approximately 4.0 gal. (15.0 L, 3.3 Imp. gal.) or less → Refuel the vehicle.
	Master warning light A buzzer sounds and the warning light comes on and flashes to indicate that the master warning system has detected a malfunction. → P. 519
	Tire pressure warning light Indicates that: <ul style="list-style-type: none"> • Flat tire • Natural causes • The tire pressure warning system is malfunctioning → Immediately stop the vehicle in a safe place. Handling method (→P. 515)
	Automatic headlight leveling system warning light Indicates a malfunction in the automatic headlight leveling system → Have the vehicle inspected by your Toyota dealer immediately.

*1: Brake system warning buzzer:

The buzzer sounds to indicate that the brake fluid level is low (with the vehicle reached a speed of 3 mph [5 km/h]).

*2: Open door warning buzzer:

The open door warning buzzer sounds to alert one or more of the doors is not fully closed (with the vehicle having reached a speed of 5 km/h [3 mph]).

*3: Driver's seat belt buzzer:

The driver's seat belt buzzer sounds to alert the driver that his or her seat belt is not fastened. Once the engine switch is turned to IGNITION ON mode, the buzzer sounds for 6 seconds. If the vehicle reaches a speed of 12 mph (20 km/h), the buzzer sounds once. If the seat belt is still unfastened after 30 seconds, the buzzer will sound intermittently for 10 seconds. Then, if the seat belt is still unfastened, the buzzer will sound in a different tone for 20 more seconds.

Front passenger's seat belt buzzer:

The front passenger's seat belt buzzer sounds to alert the front passenger that his or her seat belt is not fastened. The buzzer sounds once if the vehicle reaches a speed of 12 mph (20 km/h). If the seat belt is still unfastened after 30 seconds, the buzzer will sound intermittently for 10 seconds. Then, if the seat belt is still unfastened, the buzzer will sound in a different tone for 20 more seconds.

■ SRS warning light

This warning light system monitors the airbag sensor assembly, front impact sensors, side impact sensors (rear), side impact sensors (front door), safing sensor (rear), driver's seat belt buckle switch, driver's seat position sensor, front passenger's seat belt buckle switch, airbags, interconnecting wiring and power sources, front passenger occupant classification system, "AIR BAG ON" and "AIR BAG OFF" indicator lights, seat belt pretensioners, "RSCA OFF" indicator light. (→P. 38)

■ Front passenger detection sensor, seat belt reminder and warning buzzer

- If luggage is placed on the front passenger seat, the front passenger detection sensor may cause the warning light to flash and the warning buzzer to sound even if a passenger is not sitting in the seat.
- If a cushion is placed on the seat, the sensor may not detect a passenger, and the warning light may not operate properly.

■ If the malfunction indicator lamp comes on while driving

First check the following:

- Is the fuel tank empty?
If it is, fill the fuel tank immediately.
- Is the fuel tank cap loose?
If it is, tighten it securely.

The light will go off after several driving trips.

If the light does not go off even after several trips, contact your Toyota dealer as soon as possible.

■ If the low speed four-wheel drive indicator light or the center differential lock indicator light blinks

Take the specified steps. (→P. 282)

If the brake system warning light or the malfunction indicator light also comes on, or the low speed four-wheel drive indicator light or the center differential lock indicator light continues to blink after taking the specified steps, there may be a malfunction in the engine, the brake system or the four-wheel drive system. In this case, you may not be able to transfer between "H4" and "L4" modes, and the center differential lock may not be able to be locked or unlocked. Have the vehicle inspected by your Toyota dealer immediately.

■ When the tire pressure warning light comes on

Inspect the tires to check if a tire is punctured.

If a tire is punctured: →P. 524

If none of the tires are punctured:

Turn the engine switch off then turn it to IGNITION ON mode. Check if the tire pressure warning light comes on or flashes.

▶ If the tire pressure warning light comes on

- 1 After the temperature of the tires has lowered sufficiently, check the inflation pressure of each tire and adjust them to the specified level.
- 2 If the warning light does not turn off even after several minutes have elapsed, check that the inflation pressure of each tire is at the specified level and perform initialization. (→P. 464)

If the warning light does not turn off even after several minutes have elapsed, have the vehicle inspected by your Toyota dealer immediately.

▶ If the tire pressure warning light flashes for 1 minute then stay on

There may be a malfunction in the tire pressure warning system. Have the vehicle inspected by your Toyota dealer immediately.

■ The tire pressure warning light may turn on due to natural causes

The tire pressure warning light may turn on due to natural causes such as natural air leaks or tire inflation pressure changes caused by temperature. In this case, adjusting the tire inflation pressure will turn off the warning light (after a few minutes).

■ When a tire is replaced with a spare tire

The spare tire is also equipped with the tire pressure warning valve and transmitter. The tire pressure warning light will turn on if the tire inflation pressure of the spare tire is low. If a tire goes flat, even though the flat tire is replaced with the spare tire, the tire pressure warning light does not turn off. Replace the spare tire with the repaired tire and adjust the proper tire inflation pressure. The tire pressure warning light will turn off after a few minutes.

■ Conditions that the tire pressure warning system may not function properly

→P. 468

■ Changing the engine oil

Make sure to reset oil change system.

■ **Warning buzzer**

In some cases, the buzzer may not be heard due to being in a noisy location or audio sound.

 **WARNING**

■ **If both the ABS and the brake system warning lights remain on**

Stop your vehicle in a safe place immediately and contact your Toyota dealer. The vehicle will become extremely unstable during braking, and the ABS system may fail, which could cause an accident resulting in death or serious injury.

■ **If the tire pressure warning light comes on**

Be sure to observe the following precautions. Failure to do so could cause loss of vehicle control and result in death or serious injury.

- Stop your vehicle in a safe place as soon as possible. Adjust the tire inflation pressure immediately.
- If the tire pressure warning light comes on even after tire inflation pressure adjustment, it is probable that you have a flat tire. Check the tires. If the tire is flat, change to the spare tire and have the flat tire repaired by the nearest Toyota dealer.
- Avoid abrupt maneuvering and braking. If the vehicle tires deteriorate, you could lose control of the steering wheel or the brakes.

■ **If a blowout or sudden air leakage should occur**

The tire pressure warning system may not activate immediately.

 **WARNING****■ Maintenance of the tires**

Each tire, including the spare (if provided), should be checked monthly when cold and inflated to the inflation pressure recommended by the vehicle manufacturer on the vehicle placard or tire inflation pressure label (tire and load information label). (If your vehicle has tires of a different size than the size indicated on the vehicle placard or tire inflation pressure label [tire and load information label], you should determine the proper tire inflation pressure for those tires.)

As an added safety feature, your vehicle has been equipped with a tire pressure monitoring system (TPMS-tire pressure warning system) that illuminates a low tire pressure telltale (tire pressure warning light) when one or more of your tires is significantly under-inflated. Accordingly, when the low tire pressure telltale (tire pressure warning light) illuminates, you should stop and check your tires as soon as possible, and inflate them to the proper pressure. Driving on a significantly under-inflated tire causes the tire to overheat and can lead to tire failure. Under-inflation also reduces fuel efficiency and tire tread life, and may affect the vehicle's handling and stopping ability.

Please note that the TPMS (tire pressure warning system) is not a substitute for proper tire maintenance, and it is the driver's responsibility to maintain correct tire pressure, even if under-inflation has not reached the level to trigger illumination of the TPMS low tire pressure telltale (tire pressure warning light).

Your vehicle has also been equipped with a TPMS (tire pressure warning system) malfunction indicator to indicate when the system is not operating properly. The TPMS (tire pressure warning system) malfunction indicator is combined with the low tire pressure telltale (tire pressure warning light). When the system detects a malfunction, the telltale will flash for approximately one minute and then remain continuously illuminated. This sequence will continue upon subsequent vehicle start-ups as long as the malfunction exists. When the malfunction indicator is illuminated, the system may not be able to detect or signal low tire pressure as intended.

TPMS (tire pressure warning system) malfunctions may occur for a variety of reasons, including the installation of replacement or alternate tires or wheels on the vehicle that prevent the TPMS (tire pressure warning system) from functioning properly. Always check the TPMS (tire pressure warning system) malfunction telltale after replacing one or more tires or wheels on your vehicle to ensure that the replacement or alternate tires and wheels allow the TPMS (tire pressure warning system) to continue to function properly.

 NOTICE

■ **To ensure the tire pressure warning system operates properly**

Do not install tires with different specifications or makers, as the tire pressure warning system may not operate properly.

If a warning message is displayed

The multi-information display shows warnings of system malfunctions, incorrectly performed operations, and messages that indicate a need for maintenance. When a message is shown, perform the correction procedure appropriate to the message.

① Master warning light

The master warning light also comes on or flashes in order to indicate that a message is currently being displayed on the multi-information display.

② Multi-information display

③ Handling method

Follow the instructions of the message on the multi-information display.

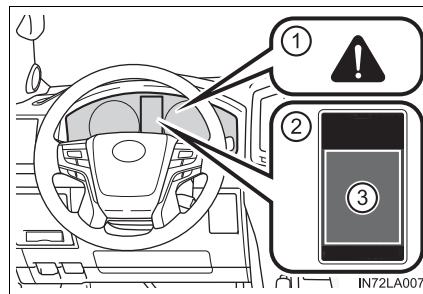

If any of the warning messages are shown again after the following actions have been performed, contact your Toyota dealer.

Messages and warnings

The warning lights and warning buzzers operate as follows depending on the content of the message. If a message indicates the need for inspection by a dealer, have the vehicle inspected by your Toyota dealer immediately.

	System warning light	Warning buzzer*	Warning
Comes on	Comes on	Sounds	Indicates an important situation, such as when a system related to driving is malfunctioning or that danger may result if the correction procedure is not performed
Comes on	—	Sounds	
—	Comes on or flashes	Sounds	Indicates an important situation, such as when the systems shown on the multi-information display may be malfunctioning
Flashes	—	Sounds	Indicates a situation, such as when damage to the vehicle or danger may result
Comes on	—	Does not sound	Indicates a condition, such as malfunction of electrical components, their condition, or indicates the need for maintenance
Flashes	—	Does not sound	Indicates a situation, such as when an operation has been performed incorrectly, or indicates how to perform an operation correctly

*: A buzzer sounds the first time a message is shown on the multi-information display.

■ System warning lights

The master warning light does not come on or flash in the following case. Instead, a separate system warning light will come on along with a message or image shown on the multi-information display.

- Indicates that the PCS (Pre-Collision System) is not currently functional
The PCS warning light comes on. (→P. 511)
- Indicates that a door is not fully closed while the vehicle is stopped.
The Open door warning light comes on. (→P. 512)

■ If “See Owner’s Manual” is shown

- If “Smart key System Malfunction” is shown, this may be a malfunction.
Immediately have the vehicle inspected by your Toyota dealer.
- If “Transmission Fluid Temp High” is shown, it indicates that the automatic transmission fluid temperature is too high.
Immediately stop the vehicle in a safe place, shift the shift lever to P and wait until the warning message and light go off. If the warning message and light go off, you may start the vehicle again. If the warning message and light do not go off, contact your Toyota dealer.

■ If “Shift to P Before Exiting Vehicle” is shown

Message is displayed when the driver's door is opened without turning the engine switch to off with the shift lever in any position other than P.
Shift the shift lever to P.

■ If “Power Turned Off to Save Battery” is shown

Power was turned off due to the automatic power off function.
Next time when starting the engine, increase the engine speed slightly and maintain that level for approximately 5 minutes to recharge the battery.

■ When a message that indicates the need for the shift lever operation is shown

To prevent the shift lever from being operated incorrectly or the vehicle from moving unexpectedly, a message that requires shifting the shift lever may be shown on the multi-information display. In that case, follow the instruction of the message and shift the shift lever.

■ When “Headlight System Malfunction Visit Your Dealer” is displayed on the multi-information display

The following systems may be malfunctioning. Have the vehicle inspected by your Toyota dealer.

- The LED headlight system
- The automatic headlight leveling system
- AHB (Automatic High Beam) (if equipped)

■ **If “Forward Camera System Unavailable” or “Forward Camera System Unavailable Clean Windshield” is displayed. (if equipped)**

The following systems may be suspended until the problem shown in the message is resolved.

- Dynamic radar cruise control
- PCS (Pre-Collision System)
- LDA (Lane Departure Alert with steering control)
- AHB (Automatic High Beam)

■ **If “Engine Oil Level Low” is shown**

Indicates that engine oil level is low.

Check the level of engine oil, and add if necessary.

This message may appear if the vehicle is stopped on a slope.

Move the vehicle to a level surface and check to see if the message disappears.

■ **If a following message is shown, take appropriate action and confirm that the message has disappeared. (→P. 284)**

- “Crawl Not Available Select L4 and Shift to [D] or [R] Position”
- “Crawl Not Available Check System Operation Conditions”
- “Turn Assist Function Not Available Check System Operation Conditions”
- “Turn Assist Function Not Available Activate Crawl Control”

■ **If “Maintenance Required Soon” is shown (U.S.A. only)**

Indicates that all maintenance according to the driven distance on the maintenance schedule* should be performed soon.

Comes on approximately 4500 miles (7200 km) after the message has been reset.

If necessary, perform maintenance.

*: Refer to the separate “Scheduled Maintenance Guide” or “Owner’s Manual Supplement” for the maintenance interval applicable to your vehicle.

■ **If “Maintenance Required Visit Your Dealer” is shown (U.S.A. only)**

Indicates that all maintenance is required to correspond to the driven distance on the maintenance schedule*.

Comes on approximately 5000 miles (8000 km) after the message has been reset. (The indicator will not work properly unless the message has been reset.)

Perform the necessary maintenance. Please reset the message after the maintenance is performed (→P. 440)

*: Refer to the separate “Scheduled Maintenance Guide” or “Owner’s Manual Supplement” for the maintenance interval applicable to your vehicle.

■ If “Oil Maintenance Required Soon” is shown

Indicates that the engine oil is scheduled to be changed. (The indicator will not work properly unless the message has been reset.)

Check the engine oil, and change if necessary. After changing the engine oil, the message should be reset. (→P. 452)

■ If “Oil Maintenance Required Visit Your Dealer” is shown

Indicates that the engine oil should be changed. (The indicator will not work properly unless the message has been reset.)

Check and change the engine oil, and oil filter by your Toyota dealer. After changing the engine oil, the message should be reset. (→P. 452)

■ If “Visit Your Dealer” is shown

The system or part shown on the multi-information display is malfunctioning. Have the vehicle inspected by your Toyota dealer immediately.

■ Warning buzzer

In some cases, the buzzer may not be heard due to being in a noisy location or audio sound.

If you have a flat tire

Your vehicle is equipped with a spare tire. The flat tire can be replaced with the spare tire.

For details about tires: →P. 463

WARNING

■ If you have a flat tire

Do not continue driving with a flat tire.

Driving even a short distance with a flat tire can damage the tire and the wheel beyond repair, which could result in an accident.

Before jacking up the vehicle

- Stop the vehicle on a hard, flat surface.
- Set the parking brake.
- Shift the shift lever to P.
- Stop the engine.
- Turn on the emergency flashers. (→P. 500)

Location of the spare tire, jack and tools

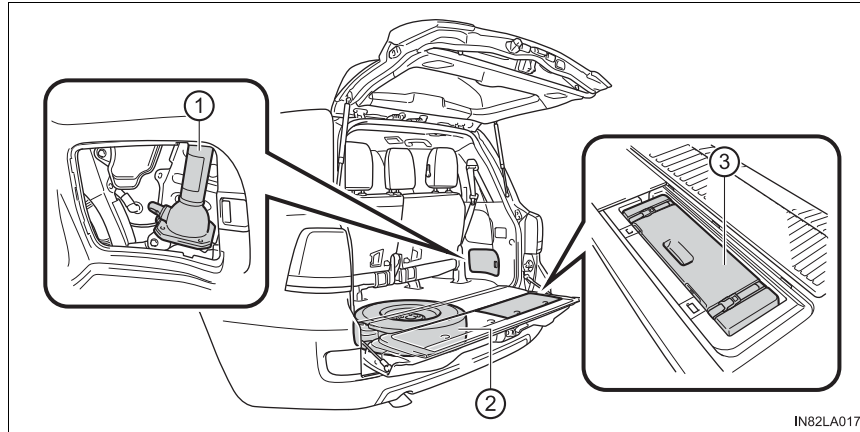

- ① Jack
- ② Spare tire
- ③ Tool box

 **WARNING**

■ **Using the tire jack**

Improper use of the tire jack may cause the vehicle to suddenly fall off the jack, leading to death or serious injury.

- Do not use the tire jack for any purpose other than replacing tires or installing and removing tire chains.
 - Only use the tire jack that comes with this vehicle for replacing a flat tire.
Do not use it on other vehicles, and do not use other tire jacks for replacing tires on this vehicle.
 - Always check that the tire jack is securely set to the jack point.
 - Do not put any part of your body under the vehicle while it is supported by the jack.
 - Do not start or run the engine while your vehicle is supported by the jack.
 - Do not raise the vehicle while someone is inside.
 - When raising the vehicle, do not put an object on or under the jack.
 - Do not raise the vehicle to a height greater than that required to replace the tire.
 - Use a jack stand if it is necessary to get under the vehicle.
- Take particular care when lowering the vehicle to ensure that no one working on or near the vehicle will be injured.

■ **Using the jack handle**

Tighten all the jack handle bolts securely using a Phillips-head screwdriver, to prevent the extension parts from coming apart unexpectedly.

Taking out the jack

- 1 Remove the cover.

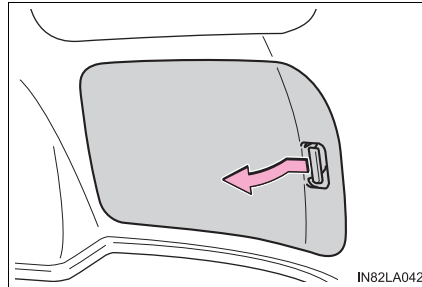

- 2 Unhook the rubber band and take out the jack.

- 1 Loosen

- 2 Tighten

Loosen and remove the jack.

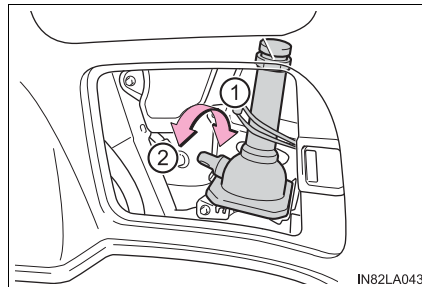
**Taking out the tool box**

- 1 Remove the cover.

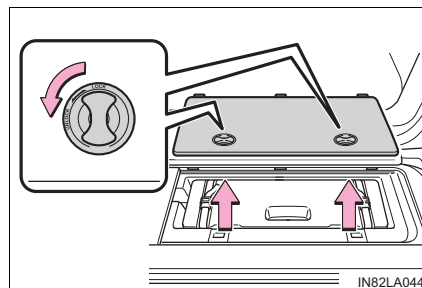

- 2 Take out the tool box.

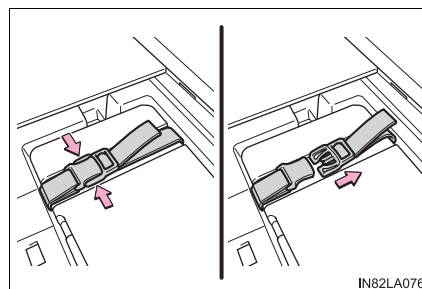

Taking out the spare tire

1 Assembling the jack handle.

Remove the jack handle and the jack handle extension bar from the tool box and assemble by following these steps.

- ① Loosen the screw using a screwdriver.

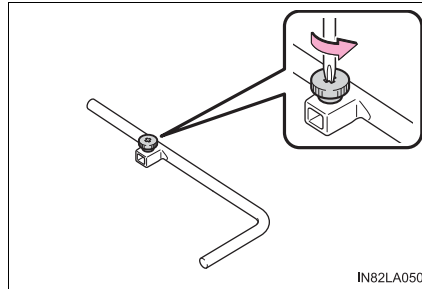

- ② Assemble the jack handle and the jack handle extension bar and tighten the screw.

Check that the screw is firmly tightened.

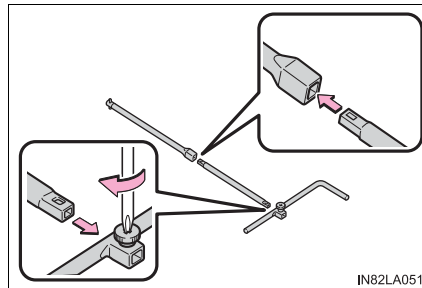

2 Open the cover.

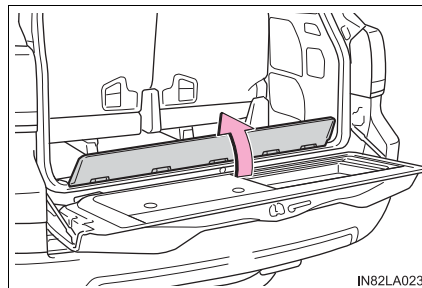

- 3 Insert the jack handle extension into the lowering screw.

- ① Lower
② Raise

Place a rag under the jack handle extension to protect the back door.

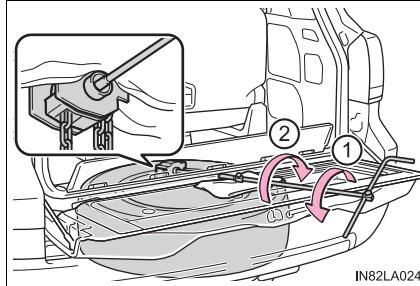

- 4 Lower the spare tire completely to the ground.

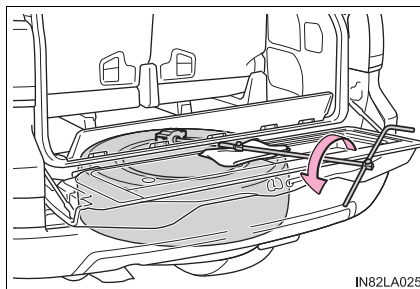

- 5 Pull out the spare tire and remove the holding bracket.

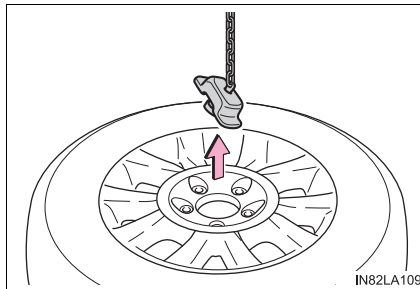

- 6 Remove the spare wheel cover.

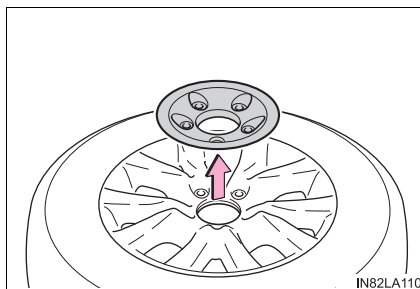

Replacing a flat tire

- 1 Check the tires.

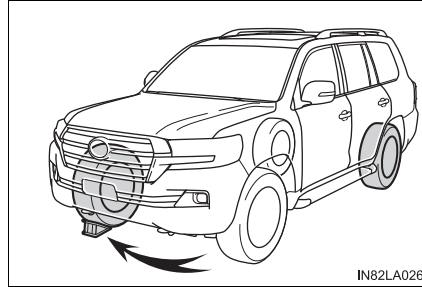

Flat tire		Wheel chock position
Front	Left-hand side	Behind the rear right-hand side tire
	Right-hand side	Behind the rear left-hand side tire
Rear	Left-hand side	In front of the front right-hand side tire
	Right-hand side	In front of the front left-hand side tire

- 2 Slightly loosen the wheel nuts (one turn).

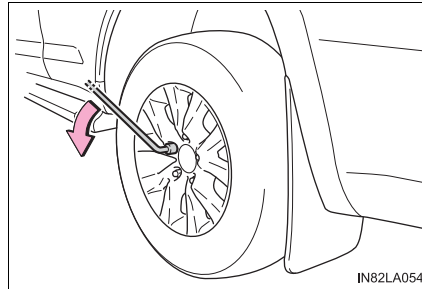

3 Assembling the jack handle.

Remove the jack handle, jack extension bar and jack handle bar from the tool box and assemble by following these steps.

- ① Loosen the bolt and the screw using either the jack handle end or a screwdriver.

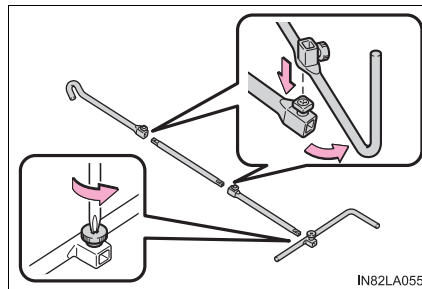

- ② Assemble the jack handle extension bar and the jack handle bar and tighten the bolts.

Check that the bolts are firmly tightened.

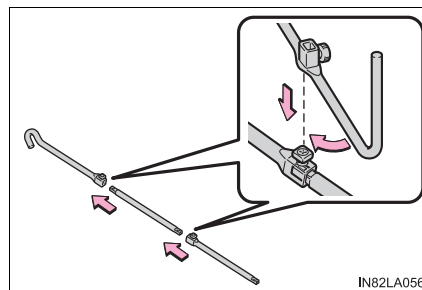

- ③ Assemble the jack handle extension bar and the jack handle and tighten the screw.

Check that the screw is firmly tightened.

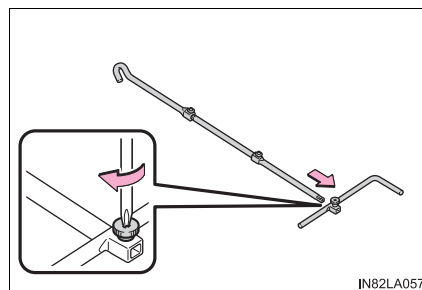

- 4 Position the jack at the jack points as shown.

- ① Front
Under the chassis frame side rail
- ② Rear
Under the rear axle housing

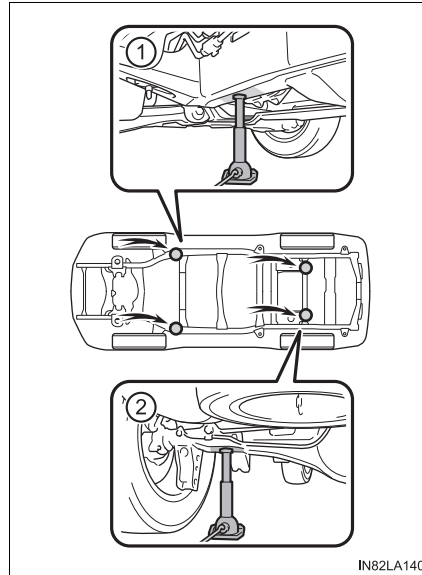

- 5 Raise the vehicle until the tire is slightly raised off the ground.

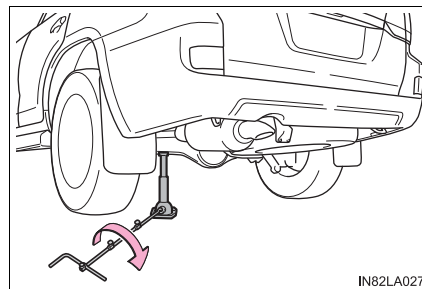

- 6 Remove all the wheel nuts and the tire.

When resting the tire on the ground, place the tire so that the wheel design faces up to avoid scratching the wheel surface.

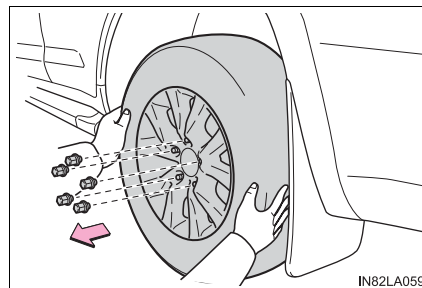

 **WARNING****■ Replacing a flat tire**

- Observe the following precautions.

Failure to do so may result in serious injury:

- Lower the spare tire completely to the ground before removing it from under the vehicle.
- Do not try to remove the wheel ornament by hand. Take due care in handling the ornament to avoid unexpected personal injury.
- Do not touch the disc wheels or the area around the brakes immediately after the vehicle has been driven.

After the vehicle has been driven the disc wheels and the area around the brakes will be extremely hot. Touching these areas with hands, feet or other body parts while changing a tire, etc. may result in burns.

- Failure to follow these precautions could cause the wheel nuts to loosen and the tire to fall off, resulting in death or serious injury.
 - Have the wheel nuts tightened with a torque wrench to 97 ft•lbf (131 N•m, 13.4 kgf•m) as soon as possible after changing wheels.
 - Do not attach a heavily damaged wheel ornament, as it may fly off the wheel while the vehicle is moving.
 - When installing a tire, only use wheel nuts that have been specifically designed for that wheel.
 - If there are any cracks or deformations in the bolt screws, nut threads or bolt holes of the wheel, have the vehicle inspected by your Toyota dealer.
 - When installing the wheel nuts, be sure to install them with the tapered ends facing inward. (→P. 476)

Installing the spare tire

- 1 Remove any dirt or foreign matter from the wheel contact surface.

If foreign matter is on the wheel contact surface, the wheel nuts may loosen while the vehicle is in motion, and the tire may come off the vehicle.

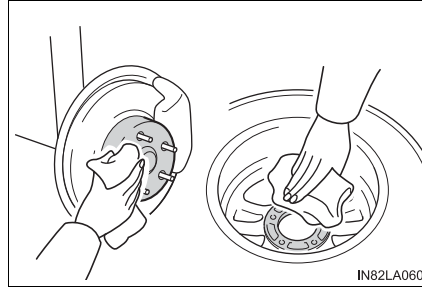

- 2 Install the spare tire and loosely tighten each nut by hand to approximately the same amount.

Turn the lug nuts until the washers come into contact with the disc wheel.

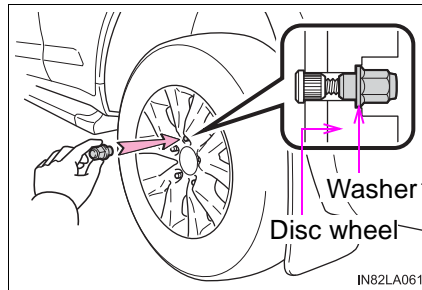

- 3 Lower the vehicle.

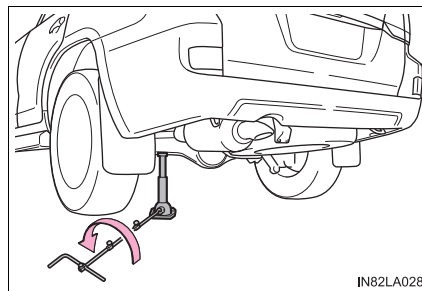

- 4 Firmly tighten each nut two or three times in the order shown in the illustration.

Tightening torque:
97 ft•lbf (131 N•m, 13.4 kgf•m)

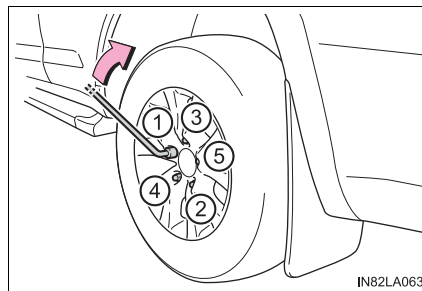

- 5 Reinstall the wheel ornament.

Remove the center wheel ornament from the flat tire by pushing from the reverse side, and reinstall it.

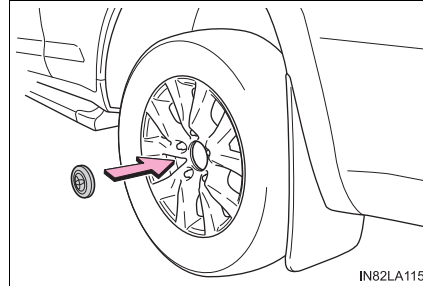

Stowing the flat/spare tire, jack and tools

- 1 Lay down the tire with the outer side facing up.
2 Install the spare wheel cover.

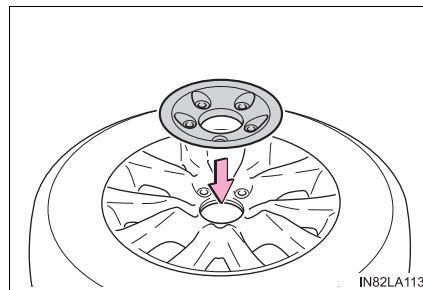

- 3 Install the holding bracket.

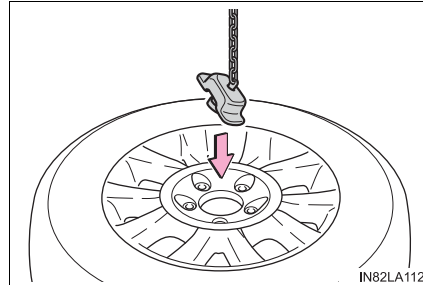

- 4 Raise the tire.
Pull the tire towards the rear of the vehicle when raising. After raising, visually check that the tire is not interfering with suspension components.
- 5 Stow the tools and jack securely, and replace all covers.

After completing the tire change

The tire pressure warning system must be reset. (→P. 464)

 **WARNING**

■ **After using the tools and jack**

Before driving, make sure all the tools and jack are securely in place in their storage location to reduce the possibility of personal injury during a collision or sudden braking.

 **NOTICE**

■ **When stowing the flat tire**

Ensure that there is no object caught between the tire and the vehicle underbody.

■ **When replacing the tires**

When removing or fitting the wheels, tires or the tire pressure warning valve and transmitter, contact your Toyota dealer as the tire pressure warning valve and transmitter may be damaged if not handled correctly.

■ **To avoid damage to the tire pressure warning valves and transmitters**

When a tire is repaired with liquid sealants, the tire pressure warning valve and transmitter may not operate properly. If a liquid sealant is used, contact your Toyota dealer or other qualified service shop as soon as possible. Make sure to replace the tire pressure warning valve and transmitter when replacing the tire. (→P. 464)

If the engine will not start

If the engine will not start even though correct starting procedures are being followed (→P. 193), consider each of the following points:

The engine will not start even when the starter motor operates normally.

One of the following may be the cause of the problem:

- There may not be sufficient fuel in the vehicle's tank.
Refuel the vehicle.
- The engine may be flooded.
Try to restart the engine again following correct starting procedures.
(→P. 193)
- There may be a malfunction in the engine immobilizer system.
(→P. 74)

The starter motor turns over slowly, the interior lights and headlights are dim, or the horn does not sound or sounds at a low volume.

One of the following may be the cause of the problem:

- The battery may be discharged. (→P. 543)
- The battery terminal connections may be loose or corroded.

The starter motor does not turn over.

The engine starting system may be malfunctioning due to an electrical problem such as an open circuit or a blown fuse. However, an interim measure is available to start the engine. (→P. 538)

The starter motor does not turn over, the interior lights and headlights do not turn on, or the horn does not sound.

One of the following may be the cause of the problem:

- One or both of the battery terminals may be disconnected.
- The battery may be discharged. (→P. 543)
- There may be a malfunction in the steering lock system.

Contact your Toyota dealer if the problem cannot be repaired, or if repair procedures are unknown.

Emergency start function

When the engine does not start, the following steps can be used as an interim measure to start the engine if the engine switch is functioning normally.

- 1 Set the parking brake.
- 2 Put the shift lever in P.
- 3 Set the engine switch to the ACCESSORY mode.
- 4 Push and hold the engine switch for about 15 seconds while depressing the brake pedal firmly.

Even if the engine can be started using the above steps, the system may be malfunctioning. Have the vehicle inspected by your Toyota dealer.

If the shift lever cannot be shifted from P

If the shift lever cannot be shifted with your foot on the brake pedal, there may be a problem with the shift lock system (a system to prevent accidental operation of the shift lever). Have the vehicle inspected by your Toyota dealer, immediately.

The following steps may be used as an emergency measure to ensure that the shift lever can be shifted:

- 1 Set the parking brake.
- 2 Turn the engine switch to ACCESSORY mode.
- 3 Depress the brake pedal.
- 4 Pry the cover up with a flathead screwdriver or equivalent tool.

To prevent damage to the cover, cover the tip of the screwdriver with a rag.

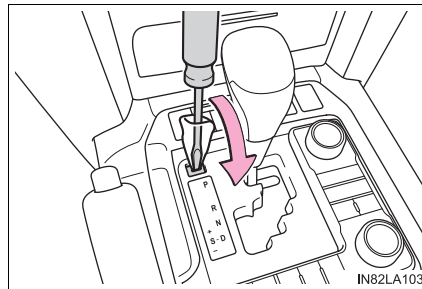

- 5 Press the shift lock override button.

The shift lever can be shifted while the button is pressed.

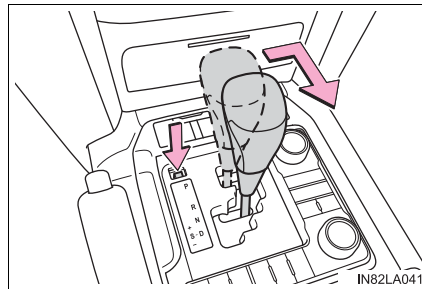

If the electronic key does not operate properly

If communication between the electronic key and vehicle is interrupted (→P. 122) or the electronic key cannot be used because the battery is depleted, the smart key system and wireless remote control cannot be used. In such cases, the doors can be opened and the engine can be started by following the procedure below.

Locking and unlocking the doors and key linked functions

Use the mechanical key (→P. 103) in order to perform the following operations (driver's door only):

- ① Locks all the doors
- ② Closes the windows and moon roof* (turn and hold)
- ③ Unlocks the doors

Turning the key rearward unlocks the driver's door. Turning the key once again unlocks the other doors.

- ④ Opens the windows and moon roof* (turn and hold)

*: These settings must be customized at your Toyota dealer.

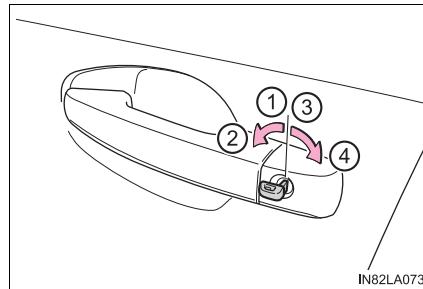



Starting the engine

- 1 Ensure that the shift lever is in P and depress the brake pedal.
- 2 Touch the Toyota emblem side of the electronic key to the engine switch.

When the electronic key is detected, a buzzer sounds and the engine switch will turn to IGNITION ON mode.

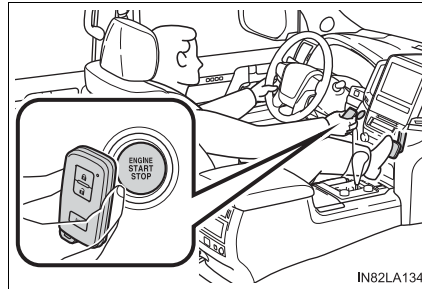
When the smart key system is deactivated in customization setting, the engine switch will turn to ACCESSORY mode.



- 3 Firmly depress the brake pedal and check that  is shown on the multi-information display.
- 4 Press the engine switch.

In the event that the engine still cannot be started, contact your Toyota dealer.

Stopping the engine

Shift the shift lever to P and press the engine switch as you normally do when stopping the engine.

Replacing the key battery

As the above procedure is a temporary measure, it is recommended that the electronic key battery be replaced immediately when the battery is depleted. (→P. 479)

Alarm

Using the mechanical key to lock the doors will not set the alarm system. If a door is unlocked using the mechanical key when the alarm system is set, the alarm may be triggered. (→P. 76)

Changing engine switch modes

Release the brake pedal and press the engine switch in 3 step above. The engine does not start and modes will be changed each time the switch is pressed. (→P. 194)

When the electronic key does not work properly

- Make sure that the smart key system has not been deactivated in the customization setting. If it is off, turn the function on. (Customizable features: →P. 574)
- Check if battery-saving mode is set. If it is set, cancel the function. (→P. 122)

 WARNING

■ **When using the mechanical key and operating the power windows or moon roof**

Operate the power window or moon roof after checking to make sure that there is no possibility of any passenger having any of their body parts caught in the window or moon roof.

Also, do not allow children to operate the mechanical key. It is possible for children and other passengers to get caught in the power window or moon roof.

If the vehicle battery is discharged

The following procedures may be used to start the engine if the battery is discharged.

You can also call your Toyota dealer or qualified repair shop.

If you have a set of jumper (or booster) cables and a second vehicle with a 12 volt battery, you can jump start your Toyota following the steps below.

- 1 Confirm that the electronic key is being carried.
When connecting the jumper (or booster) cables, depending on the situation, the alarm may activate and doors locked.
(→P. 78)

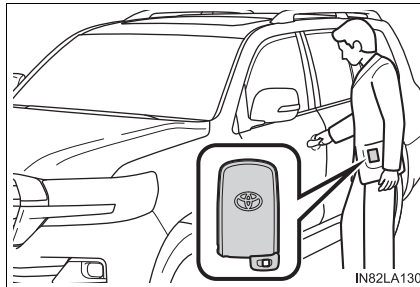

- 2 Open the hood.
- 3 Connecting the jumper cables.

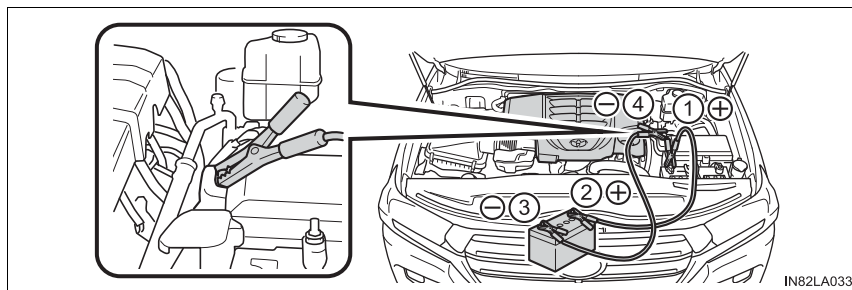

- ① Positive (+) battery terminal on your vehicle.
- ② Positive (+) battery terminal on the second vehicle.
- ③ Negative (-) battery terminal on the second vehicle.
- ④ Connect the jumper cable to ground on your vehicles as shown in the illustration.

- 4 Start the engine of the second vehicle. Increase the engine speed slightly and maintain at that level for approximately 5 minutes to recharge the battery of your vehicle.
- 5 Open and close any of the doors with the “ENGINE START STOP” switch off.
- 6 Maintain the engine speed of the second vehicle and start your vehicle’s engine.
- 7 Once the vehicle’s engine has started, remove the jumper cables in the exact reverse order in which they were connected.

Once the engine starts, have the vehicle checked at your Toyota dealer as soon as possible.

■ Starting the engine when the battery is discharged

The engine cannot be started by push-starting.

■ Avoiding a discharged battery

- Turn off the headlights and the audio system while the engine is off.
- Turn off any unnecessary electrical components when the vehicle is running at a low speed for an extended period, such as in heavy traffic, etc.

■ Charging the battery

The electricity stored in the battery will discharge gradually even when the vehicle is not in use, due to natural discharge and the draining effects of certain electrical appliances. If the vehicle is left for a long time, the battery may discharge, and the engine may be unable to start. (The battery recharges automatically during driving.)

⚠ WARNING**■ Avoiding battery fires or explosions**

Observe the following precautions to prevent accidentally igniting the flammable gas that may be emitted from the battery.

- Make sure the jumper cable is connected to the correct terminal and that it is not unintentionally in contact with any part other than the intended terminal.
- Do not allow the jumper cables to come into contact with the “+” and “-” terminals.
- Do not allow open flame or use matches, cigarette lighters or smoke near the battery.

 **WARNING****■ Battery precautions**

The battery contains poisonous and corrosive acidic electrolyte, while related parts contain lead and lead compounds. Observe the following precautions when handling the battery:

- When working with the battery, always wear safety glasses and take care not to allow any battery fluids (acid) to come into contact with skin, clothing or the vehicle body.
- Do not lean over the battery.
- If the battery fluid comes into contact with the skin or eyes, immediately wash the affected area with water and seek medical attention. Place a wet sponge or cloth over the affected area until medical attention can be received.
- Always wash your hands after handling the battery support, terminals, and other battery-related parts.
- Do not allow children near the battery.

 **NOTICE****■ When handling jumper cables**

Be careful that the jumper cables do not become tangled in the cooling fan or any of the belts when connecting or disconnecting them.

If your vehicle overheats

The following may indicate that your vehicle is overheating.

- The needle of the engine coolant temperature gauge (→P. 85) enters the red zone or a loss of engine power is experienced. (For example, the vehicle speed does not increase.)
- Steam is coming from under the hood.

Correction procedures

- 1 Stop the vehicle in a safe place and turn off the air conditioning system, and then stop the engine.
- 2 If you see steam:
Carefully lift the hood after the steam subsides.
If you do not see steam:
Carefully lift the hood.
- 3 After the engine has cooled down sufficiently, inspect the hoses and radiator core (radiator) for any leaks.
 - ① Radiator
 - ② Cooling fansIf a large amount of coolant leaks, immediately contact your Toyota dealer.

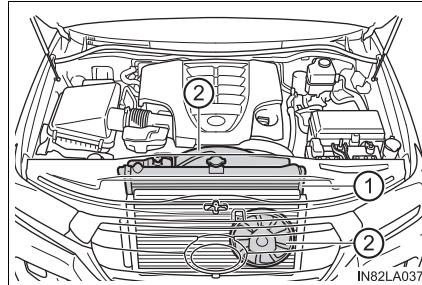

- 4 The coolant level is satisfactory if it is between the “F” and “L” lines on the reservoir.

- ① Reservoir
- ② “F”
- ③ “L”
- ④ Radiator cap

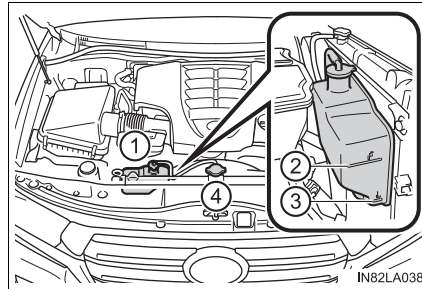

- 5 Add coolant if necessary.
Water can be used in an emergency if coolant is unavailable.

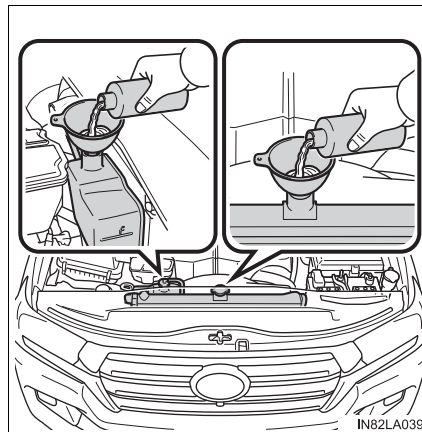

- 6 Start the engine and turn the air conditioning system on to check that the air conditioning condenser cooling fans operate and to check for coolant leaks from the radiator or hoses.

The fans operate when the air conditioning system is turned on immediately after a cold start. Confirm that the fans are operating by checking the fan sound and air flow. If it is difficult to check these, turn the air conditioning system on and off repeatedly.
(The fans may not operate in freezing temperatures.)

- 7 If the fans are not operating:
Stop the engine immediately and contact your Toyota dealer.
- If the fans are operating:
Have the vehicle inspected at the nearest Toyota dealer.

 **WARNING**

■ **When inspecting under the hood of your vehicle**

Observe the following precautions.

Failure to do so may result in serious injury such as burns.

- If steam is seen coming from under the hood, do not open the hood until the steam has subsided. The engine compartment may be very hot.
- Keep hands and clothing (especially a tie, a scarf or a muffler) away from the fans and belts. Failure to do so may cause the hands or clothing to be caught, resulting in serious injury.
- Do not loosen the radiator cap or the coolant reservoir cap while the engine and radiator are hot. High temperature steam or coolant could spray out.

 **NOTICE**

■ **When adding engine coolant**

Add coolant slowly after the engine has cooled down sufficiently. Adding cool coolant to a hot engine too quickly can cause damage to the engine.

■ **To prevent damage to the cooling system**

Observe the following precautions:

- Avoid contaminating the coolant with foreign matter (such as sand or dust etc.).
- Do not use any coolant additives.

If the vehicle becomes stuck

Carry out the following procedures if the tires spin or the vehicle becomes stuck in mud, dirt, or snow:

- 1 Stop the engine. Set the parking brake and shift the shift lever to P.
- 2 Remove the mud, snow or sand from around the rear wheels.
- 3 Place wood, stones or some other material under the rear wheels to help provide traction.
- 4 Restart the engine.
- 5 Shift the shift lever to the D or R position and release the parking brake. Then, while exercising caution, depress the accelerator pedal.

■ When it is difficult to free the vehicle

Press  to turn off Active TRAC.

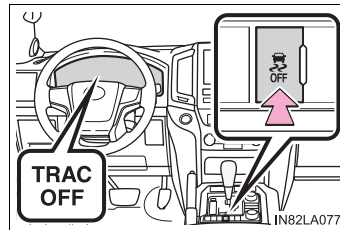

 **WARNING****■ When attempting to free a stuck vehicle**

If you choose to push the vehicle back and forth to free it, make sure the surrounding area is clear, to avoid striking other vehicles, objects or people. The vehicle may also lunge forward or lunge back suddenly as it becomes free. Use extreme caution.

■ When shifting the shift lever

Be careful not to shift the shift lever with the accelerator pedal depressed. This may lead to unexpected rapid acceleration of the vehicle that may cause an accident and result in death or serious injury.

 **NOTICE****■ To avoid damaging the transmission and other components**

- Avoid spinning the rear wheels and depressing the accelerator pedal more than necessary.
- If the vehicle remains stuck even after these procedures are performed, the vehicle may require towing to be freed.
- When a warning message for the automatic transmission fluid temperature is displayed while attempting to free a stuck vehicle, immediately remove your foot from the accelerator pedal and wait until the warning message disappears. Otherwise, the transmission may become damaged.
(→P. 519)

Vehicle specifications

8

551

8-1. Specifications

Maintenance data (fuel, oil level, etc.)	552
Fuel information	560
Tire information	563

8-2. Customization

Customizable features	574
Items to initialize	584

Maintenance data (fuel, oil level, etc.)

Dimensions and weights

Overall length	196.5 in. (4990 mm)	
Overall width	78.0 in. (1980 mm)	
Overall height* ¹	74.0 in. (1880 mm)* ² 76.2 in. (1935 mm)* ³	
Wheelbase	112.2 in. (2850 mm)	
Tread	Front	65.0 in. (1650 mm)
	Rear	64.8 in. (1645 mm)
Vehicle capacity weight (Occupants + luggage)	1320 lb. (600 kg)	
TWR (trailer weight + cargo weight)	8100 lb. (3670 kg)	

*1: Unladen vehicle

*2: Vehicles without roof rail and cross rail

*3: Vehicles with roof rail and cross rail

Vehicle identification

■ **Vehicle identification number**

The vehicle identification number (VIN) is the legal identifier for your vehicle. This is the primary identification number for your Toyota. It is used in registering the ownership of your vehicle.

This number is stamped on the top left of the instrument panel.

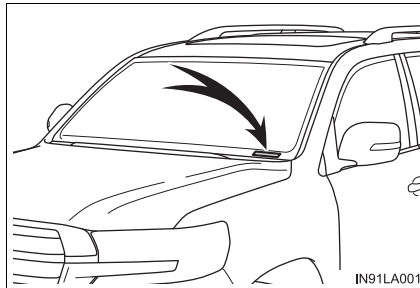

This number is also on the Certification Label.

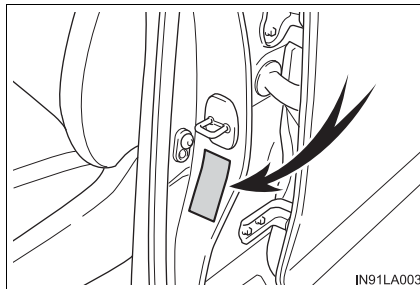

■ **Engine number**

The engine number is stamped on the engine block as shown.

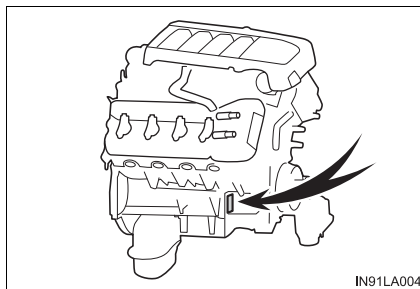

Engine

Model	5.7L V8 (3UR-FE)
Type	8-cylinder V type, 4-cycle, gasoline
Bore and stroke	3.70 × 4.02 in. (94.0 × 102.0 mm)
Displacement	345.6 cu.in. (5663 cm ³)
Valve clearance	Automatic adjustment
Drive belt tension	Automatic adjustment

Fuel

Fuel type	Unleaded gasoline only
Octane rating	87 (Research octane number 91) or higher
Fuel tank capacity (Reference)	24.5 gal. (93 L, 20.4 Imp.gal)

Lubrication system

Oil capacity (Drain and refill — reference*)	
With filter	7.9 qt. (7.5 L, 6.6 Imp.qt.)
Without filter	7.5 qt. (7.1 L, 6.2 Imp.qt.)

*: The engine oil capacity is a reference quantity to be used when changing the engine oil. Warm up and turn off the engine, wait more than 5 minutes, and check the oil level on the dipstick.

■ **Engine oil selection**

“Toyota Genuine Motor Oil” is used in your Toyota vehicle. Use Toyota approved “Toyota Genuine Motor Oil” or equivalent to satisfy the following grade and viscosity.

Oil grade: ILSAC GF-5 multigrade engine oil

Recommended viscosity: SAE 0W-20

SAE 0W-20 is the best choice for good fuel economy and good starting in cold weather. If SAE 0W-20 is not available, SAE 5W-20 oil may be used. However, it must be replaced with SAE 0W-20 at the next oil change.

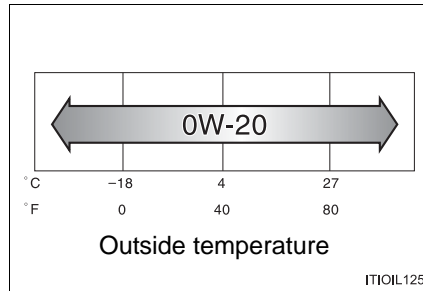

Oil viscosity (0W-20 is explained here as an example):

- The 0W in 0W-20 indicates the characteristic of the oil which allows cold startability. Oils with a lower value before the W allow for easier starting of the engine in cold weather.
- The 20 in 0W-20 indicates the viscosity characteristic of the oil when the oil is at high temperature. An oil with a higher viscosity (one with a higher value) may be better suited if the vehicle is operated at high speeds, or under extreme load conditions.

How to read oil container label:

The International Lubricant Specification Advisory Committee (ILSAC) Certification Mark is added to some oil containers to help you select the oil you should use.



Cooling system

Capacity	17.1 qt. (16.2 L, 14.3 Imp.qt.)
Coolant type	Use either of the following: <ul style="list-style-type: none"> • “Toyota Super Long Life Coolant” • Similar high-quality ethylene glycol-based non-silicate, non-amine, non-nitrite, and non-borate coolant with long-life hybrid organic acid technology Do not use plain water alone.

Ignition system

Spark plug	
Make	DENSO SK20HR11
Gap	0.043 in. (1.1 mm)

 NOTICE**■ Iridium-tipped spark plugs**

Use only iridium-tipped spark plugs. Do not adjust gap when tuning engine.

Electrical system

Battery	
Open voltage at 68°F (20°C):	12.6 — 12.8 V Fully charged 12.2 — 12.4 V Half charged 11.8 — 12.0 V Discharged (Voltage is checked 20 minutes after the engine and all lights turned off.)
Charging rates	5 A max.

Differential

Oil capacity	Front	2.01 qt. (1.90 L, 1.67 Imp.qt.)
	Rear	4.44 qt. (4.20 L, 3.70 Imp.qt.)
Oil type and viscosity	Toyota Genuine Differential gear oil LT 75W-85 GL-5 or equivalent	

Your Toyota vehicle is filled with “Toyota Genuine Differential Oil” at the factory.

Use Toyota approved “Toyota Genuine Differential Gear Oil” or an equivalent of matching quality to satisfy the above specification. Please contact your Toyota dealer for further details.

Automatic transmission

Fluid capacity	10.7 qt. (10.1 L, 8.9 Imp.qt.)
Fluid type	Toyota Genuine ATF WS

The fluid capacity is the quantity of reference. If replacement is necessary, contact your Toyota dealer.

 NOTICE

■ **Automatic transmission fluid type**

Using transmission fluid other than “Toyota Genuine ATF WS” may cause deterioration in shift quality, locking up of your transmission accompanied by vibration, and ultimately damage the transmission of your vehicle.

Transfer

Oil capacity	1.53 qt. (1.45 L, 1.28 Imp.qt.)
Oil type*	Toyota Genuine Transfer Gear oil LF or equivalent
Recommended oil viscosity	SAE 75W

*: Your Toyota vehicle is filled with “Toyota Genuine Transfer Gear oil LF” at the factory. Use Toyota approved “Toyota Genuine Transfer Gear oil LF” or an equivalent of matching quality to satisfy the above specification. Please contact your Toyota dealer for further details.

Brakes

Pedal clearance ^{*1}	4.49 in. (114 mm) Min.
Pedal free play	0.04 — 0.24 in. (1.0 — 6.0 mm)
Brake pad wear limit	0.04 in. (1.0 mm)
Parking brake lining wear limit	0.04 in. (1.0 mm)
Parking brake adjustment ^{*2}	5 — 7 clicks
Fluid type	SAE J1703 or FMVSS No. 116 DOT 3

*1: Minimum pedal clearance when depressed with a force of 110 lbf (490 N, 50 kgf) while the engine is running.

*2: Parking brake lever travel when pulled with a force of 45 lbf (200 N, 20 kgf).

Chassis lubrication

Propeller shafts	Spider	Lithium base chassis grease, NLGI No.2
	Slide yoke	Molybdenum-disulfide lithium base chassis grease, NLGI No.2 or lithium base chassis grease, NLGI No.2

Steering

Free play	Less than 1.18 in. (30 mm)
Power steering fluid type	Automatic transmission fluid DEXRON [®] II or III

Tires and wheels

Tire size	285/60R18 116V
Tire inflation pressure (Recommended cold tire inflation pressure)	Front tires: 33 psi (230 kPa, 2.3 kgf/cm ² or bar) Rear tires: 33 psi (230 kPa, 2.3 kgf/cm ² or bar) Spare tire: 33 psi (230 kPa, 2.3 kgf/cm ² or bar)
Wheel size	18 × 8 J
Wheel nut torque	97 ft•lbf (131 N•m, 13.4 kgf•m)

Light bulbs

	Light bulbs	Bulb No.	W	Type
Exterior	Front turn signal lights	7444NA	28	A
	Front side marker lights	—	5	A
	Rear turn signal lights	—	21	A
	Back-up lights	921	16	A
	License plate lights	—	5	A
Interior	Vanity lights	—	2	B

A: Wedge base bulbs

B: Double end bulbs

Fuel information

You must only use unleaded gasoline. Select octane rating 87 (Research Octane Number 91) or higher. Use of unleaded gasoline with an octane rating lower than 87 may result in engine knocking. Persistent knocking can lead to engine damage.

At minimum, the gasoline you use should meet the specifications of ASTM D4814 in the U.S.A..

■ Gasoline quality

In very few cases, driveability problems may be caused by the brand of gasoline you are using. If driveability problems persist, try changing the brand of gasoline. If this does not correct the problem, consult your Toyota dealer.

■ Gasoline quality standards

- Automotive manufacturers in the U.S.A., Europe and Japan have developed a specification for fuel quality called the World-Wide Fuel Charter (WWFC), which is expected to be applied worldwide.
- The WWFC consists of four categories that are based on required emission levels. In the U.S., category 4 has been adopted.
- The WWFC improves air quality by lowering emissions in vehicle fleets, and improves customer satisfaction through better performance.

■ Recommendation of the use of gasoline containing detergent additives

- Toyota recommends the use of gasoline that contains detergent additives to avoid the build-up of engine deposits.
- All gasoline sold in the U.S.A. contains minimum detergent additives to clean and/or keep clean intake systems, per EPA's lowest additives concentration program.
- Toyota strongly recommends the use of Top Tier Detergent Gasoline. For more information on Top Tier Detergent Gasoline and a list of marketers, please go to the official website www.toptiergas.com.

■ Recommendation of the use of low emissions gasoline

Gasolines containing oxygenates such as ethers and ethanol, as well as reformulated gasolines, are available in some cities. These fuels are typically acceptable for use, providing they meet other fuel requirements.

Toyota recommends these fuels, since the formulations allow for reduced vehicle emissions.

■ Non-recommendation of the use of blended gasoline

- Use only gasoline containing up to 15% ethanol.
DO NOT use any flex-fuel or gasoline that could contain more than 15% ethanol, including from any pump labeled E30, E50, E85 (which are only some examples of fuel containing more than 15% ethanol).

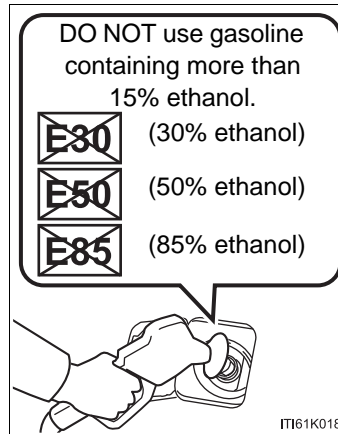

- If you use gasohol in your vehicle, be sure that it has an octane rating no lower than 87.
- Toyota does not recommend the use of gasoline containing methanol.

■ Non-recommendation of the use of gasoline containing MMT

Some gasoline contains an octane enhancing additive called MMT (Methylcyclopentadienyl Manganese Tricarbonyl).

Toyota does not recommend the use of gasoline that contains MMT. If fuel containing MMT is used, your emission control system may be adversely affected.

The malfunction indicator lamp on the instrument cluster may come on. If this happens, contact your Toyota dealer for service.

■ If your engine knocks

- Consult your Toyota dealer.
- You may occasionally notice light knocking for a short time while accelerating or driving uphill. This is normal and there is no need for concern.

 NOTICE

■ **Notice on fuel quality**

- Do not use improper fuels. If improper fuels are used the engine will be damaged.
- Do not use leaded gasoline.
Leaded gasoline can cause damage to your vehicle's three-way catalytic converters causing the emission control system to malfunction.
- Do not use gasohol other than the type previously stated.
Other gasohol may cause fuel system damage or vehicle performance problems.
- Using unleaded gasoline with an octane number or rating lower than the level previously stated will cause persistent heavy knocking.
At worst, this will lead to engine damage.

■ **Fuel-related poor driveability**

If poor driveability (poor hot starting, vaporization, engine knocking, etc.) is encountered after using a different type of fuel, discontinue the use of that type of fuel.

■ **When refueling with gasohol**

Take care not to spill gasohol. It can damage your vehicle's paint.

Tire information

Typical tire symbols

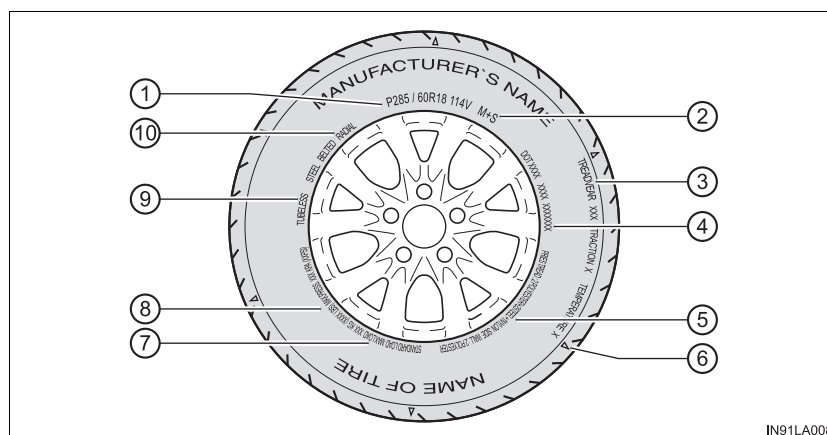

- ① Tire size (→P. 565)
- ② Summer tires or all season tires (→P. 467)
An all season tire has “M+S” on the sidewall. A tire not marked “M+S” is a summer tire.
- ③ Uniform tire quality grading
For details, see “Uniform Tire Quality Grading” that follows.
- ④ DOT and Tire Identification Number (TIN) (→P. 564)
- ⑤ Tire ply composition and materials
Plies are layers of rubber-coated parallel cords. Cords are the strands which form the plies in a tire.
- ⑥ Location of treadwear indicators (→P. 463)
- ⑦ Load limit at maximum cold tire inflation pressure (→P. 569)
- ⑧ Maximum cold tire inflation pressure (→P. 569)
This means the pressure to which a tire may be inflated.
- ⑨ TUBELESS or TUBE TYPE
A tubeless tire does not have a tube and air is directly put into the tire. A tube type tire has a tube inside the tire and the tube maintains the air pressure.
- ⑩ Radial tires or bias-ply tires
A radial tire has “RADIAL” on the sidewall. A tire not marked “RADIAL” is a bias-ply tire.

Typical DOT and Tire Identification Number (TIN)

- ① DOT symbol*
- ② Tire Identification Number (TIN)
- ③ Tire manufacturer's identification mark
- ④ Tire size code
- ⑤ Manufacturer's optional tire type code (3 or 4 letters)
- ⑥ Manufacturing week
- ⑦ Manufacturing year

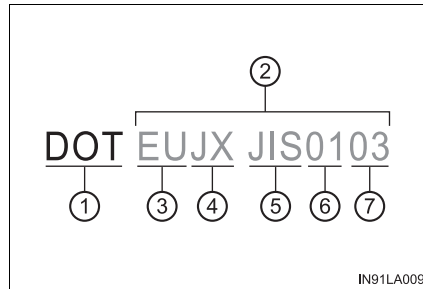

*: The DOT symbol certifies that the tire conforms to applicable Federal Motor Vehicle Safety Standards.

Tire size

■ **Typical tire size information**

The illustration indicates typical tire size.

- ① Tire use (P = Passenger car, T = Temporary use)
- ② Section width (millimeters)
- ③ Aspect ratio (tire height to section width)
- ④ Tire construction code (R = Radial, D = Diagonal)
- ⑤ Wheel diameter (inches)
- ⑥ Load index (2 digits or 3 digits)
- ⑦ Speed symbol (alphabet with one letter)

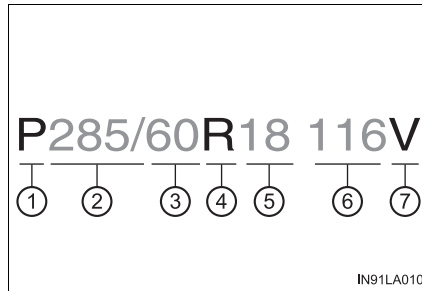

■ **Tire dimensions**

- ① Section width
- ② Tire height
- ③ Wheel diameter

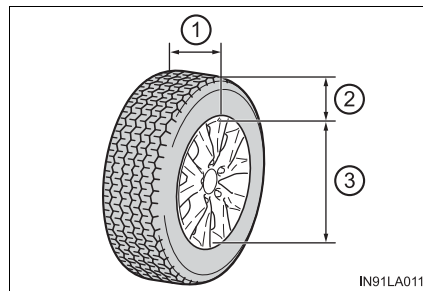

Tire section names

- ① Bead
- ② Sidewall
- ③ Shoulder
- ④ Tread
- ⑤ Belt
- ⑥ Inner liner
- ⑦ Reinforcing rubber
- ⑧ Carcass
- ⑨ Rim lines
- ⑩ Bead wires
- ⑪ Chafer

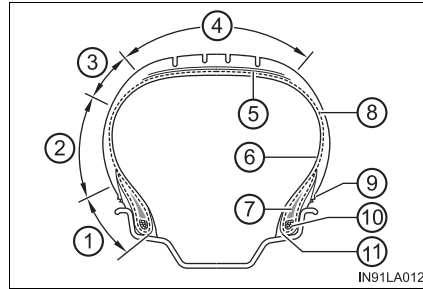

Uniform Tire Quality Grading

This information has been prepared in accordance with regulations issued by the National Highway Traffic Safety Administration of the U.S. Department of Transportation.

It provides the purchasers and/or prospective purchasers of Toyota vehicles with information on uniform tire quality grading.

Your Toyota dealer will help answer any questions you may have as you read this information.

■ DOT quality grades

All passenger vehicle tires must conform to Federal Safety Requirements in addition to these grades. Quality grades can be found where applicable on the tire sidewall between tread shoulder and maximum section width.

For example: Treadwear 200 Traction AA Temperature A

■ Treadwear

The treadwear grade is a comparative rating based on the wear rate of the tire when tested under controlled conditions on a specified government test course.

For example, a tire graded 150 would wear one and a half (1 - 1/2) times as well on the government course as a tire graded 100.

The relative performance of tires depends upon the actual conditions of their use. Performance may differ significantly from the norm due to variations in driving habits, service practices and differences in road characteristics and climate.

■ Traction AA, A, B, C

The traction grades, from highest to lowest, are AA, A, B and C, and they represent the tire's ability to stop on wet pavement as measured under controlled conditions on specified government test surfaces of asphalt and concrete.

A tire marked C may have poor traction performance.

Warning: The traction grade assigned to this tire is based on braking (straight ahead) traction tests and does not include cornering (turning) traction.

■ **Temperature A, B, C**

The temperature grades are A (the highest), B, and C, representing the tire's resistance to the generation of heat and its ability to dissipate heat when tested under controlled conditions on a specified indoor laboratory test wheel.

Sustained high temperature can cause the material of the tire to degenerate and reduce tire life, and excessive temperature can lead to sudden tire failure.

Grade C corresponds to a level of performance which all passenger car tires must meet under the Federal Motor Vehicle Safety Standard No. 109.

Grades B and A represent higher levels of performance on the laboratory test wheel than the minimum required by law.

Warning: The temperature grades of a tire assume that it is properly inflated and not overloaded.

Excessive speed, underinflation, or excessive loading, either separately or in combination, can cause heat buildup and possible tire failure.

Glossary of tire terminology

Tire related term	Meaning
Cold tire inflation pressure	Tire pressure when the vehicle has been parked for three hours or more, or has not been driven more than 1 mile or 1.5 km under that condition
Maximum inflation pressure	The maximum cold inflated pressure to which a tire may be inflated, shown on the sidewall of the tire
Recommended inflation pressure	Cold tire inflation pressure recommended by a manufacturer
Accessory weight	The combined weight (in excess of those standard items which may be replaced) of automatic transmission, power steering, power brakes, power windows, power seats, radio and heater, to the extent that these items are available as factory-installed equipment (whether installed or not)
Curb weight	The weight of a motor vehicle with standard equipment, including the maximum capacity of fuel, oil and coolant, and if so equipped, air conditioning and additional weight optional engine
Maximum loaded vehicle weight	The sum of: (a) Curb weight (b) Accessory weight (c) Vehicle capacity weight (d) Production options weight
Normal occupant weight	150 lb. (68 kg) times the number of occupants specified in the second column of Table 1* that follows
Occupant distribution	Distribution of occupants in a vehicle as specified in the third column of Table 1* below
Production options weight	The combined weight of installed regular production options weighing over 5 lb. (2.3 kg) in excess of the standard items which they replace, not previously considered in curb weight or accessory weight, including heavy duty brakes, ride levelers, roof rack, heavy duty battery, and special trim

Tire related term	Meaning
Rim	A metal support for a tire or a tire and tube assembly upon which the tire beads are seated
Rim diameter (Wheel diameter)	Nominal diameter of the bead seat
Rim size designation	Rim diameter and width
Rim type designation	The industry manufacturer's designation for a rim by style or code
Rim width	Nominal distance between rim flanges
Vehicle capacity weight (Total load capacity)	The rated cargo and luggage load plus 150 lb. (68 kg) times the vehicle's designated seating capacity
Vehicle maximum load on the tire	The load on an individual tire that is determined by distributing to each axle its share of the maximum loaded vehicle weight, and dividing by two
Vehicle normal load on the tire	The load on an individual tire that is determined by distributing to each axle its share of curb weight, accessory weight, and normal occupant weight (distributed in accordance with Table 1* below), and dividing by two
Weather side	The surface area of the rim not covered by the inflated tire
Bead	The part of the tire that is made of steel wires, wrapped or reinforced by ply cords and that is shaped to fit the rim
Bead separation	A breakdown of the bond between components in the bead
Bias ply tire	A pneumatic tire in which the ply cords that extend to the beads are laid at alternate angles substantially less than 90 degrees to the centerline of the tread
Carcass	The tire structure, except tread and sidewall rubber which, when inflated, bears the load
Chunking	The breaking away of pieces of the tread or sidewall
Cord	The strands forming the plies in the tire

Tire related term	Meaning
Cord separation	The parting of cords from adjacent rubber compounds
Cracking	Any parting within the tread, sidewall, or innerliner of the tire extending to cord material
CT	A pneumatic tire with an inverted flange tire and rim system in which the rim is designed with rim flanges pointed radially inward and the tire is designed to fit on the underside of the rim in a manner that encloses the rim flanges inside the air cavity of the tire
Extra load tire	A tire designed to operate at higher loads and at higher inflation pressures than the corresponding standard tire
Groove	The space between two adjacent tread ribs
Innerliner	The layer(s) forming the inside surface of a tubeless tire that contains the inflating medium within the tire
Innerliner separation	The parting of the innerliner from cord material in the carcass
Intended sidewall outboard	(a) The sidewall that contains a whitewall, bears white lettering, or bears manufacturer, brand, and/or model name molding that is higher or deeper than the same molding on the other sidewall of the tire, or (b) The outward facing sidewall of an asymmetrical tire that has a particular side that must always face outward when mounted on a vehicle
Light truck (LT) tire	A tire designated by its manufacturer as primarily intended for use on lightweight trucks or multipurpose passenger vehicles
Load rating	The maximum load that a tire is rated to carry for a given inflation pressure
Maximum load rating	The load rating for a tire at the maximum permissible inflation pressure for that tire
Maximum permissible inflation pressure	The maximum cold inflation pressure to which a tire may be inflated
Measuring rim	The rim on which a tire is fitted for physical dimension requirements

Tire related term	Meaning
Open splice	Any parting at any junction of tread, sidewall, or innerliner that extends to cord material
Outer diameter	The overall diameter of an inflated new tire
Overall width	The linear distance between the exteriors of the sidewalls of an inflated tire, including elevations due to labeling, decorations, or protective bands or ribs
Passenger car tire	A tire intended for use on passenger cars, multipurpose passenger vehicles, and trucks, that have a gross vehicle weight rating (GVWR) of 10,000 lb. or less.
Ply	A layer of rubber-coated parallel cords
Ply separation	A parting of rubber compound between adjacent plies
Pneumatic tire	A mechanical device made of rubber, chemicals, fabric and steel or other materials, that, when mounted on an automotive wheel, provides the traction and contains the gas or fluid that sustains the load
Radial ply tire	A pneumatic tire in which the ply cords that extend to the beads are laid at substantially 90 degrees to the centerline of the tread
Reinforced tire	A tire designed to operate at higher loads and at higher inflation pressures than the corresponding standard tire
Section width	The linear distance between the exteriors of the sidewalls of an inflated tire, excluding elevations due to labeling, decoration, or protective bands
Sidewall	That portion of a tire between the tread and bead
Sidewall separation	The parting of the rubber compound from the cord material in the sidewall

Tire related term	Meaning
Snow tire	A tire that attains a traction index equal to or greater than 110, compared to the ASTM E-1136 Standard Reference Test Tire, when using the snow traction test as described in ASTM F-1805-00, Standard Test Method for Single Wheel Driving Traction in a Straight Line on Snow-and Ice-Covered Surfaces, and which is marked with an Alpine Symbol () on at least one sidewall
Test rim	The rim on which a tire is fitted for testing, and may be any rim listed as appropriate for use with that tire
Tread	That portion of a tire that comes into contact with the road
Tread rib	A tread section running circumferentially around a tire
Tread separation	Pulling away of the tread from the tire carcass
Treadwear indicators (TWI)	The projections within the principal grooves designed to give a visual indication of the degrees of wear of the tread
Wheel-holding fixture	The fixture used to hold the wheel and tire assembly securely during testing

*: Table 1 — Occupant loading and distribution for vehicle normal load for various designated seating capacities

Designated seating capacity, Number of occupants	Vehicle normal load, Number of occupants	Occupant distribution in a normally loaded vehicle
2 through 4	2	2 in front
5 through 10	3	2 in front, 1 in second seat
11 through 15	5	2 in front, 1 in second seat, 1 in third seat, 1 in fourth seat
16 through 20	7	2 in front, 2 in second seat, 2 in third seat, 1 in fourth seat

Customizable features

Your vehicle includes a variety of electronic features that can be personalized to suit your preferences. The settings of these features can be changed by using the navigation system, the multi-information display, or at your Toyota dealer.

Customizing vehicle features





When customizing vehicle features, ensure that the vehicle is parked in a safe place with the shift lever in P and the parking brake set.

■ Changing by using the navigation system

- 1 Press the "SETUP" button on the navigation system.
- 2 Select "Vehicle" on the "Setup" screen.

Various setting can be changed. Refer to the list of settings that can be changed for details.

■ Changing by using the multi-information display

- 1 Use the meter control switches to select  on the multi-information display.
- 2 Choose the desired item using , and then press .
- 3 Select the desired setting by operating , and then press .

To stop the selection, press  to return to the previous screen.

Customizable features

Some function settings are changed simultaneously with other functions being customized. Contact your Toyota dealer for further details.

- ① Settings that can be changed using the navigation system
- ② Settings that can be changed using the multi-information display
- ③ Settings that can be changed by your Toyota dealer

Definition of symbols: O = Available, – =Not available

■ Smart key system (→P. 120)

Function	Default setting	Customized setting	①	②	③
Smart key system	On	Off	O	–	O
Smart door unlocking	Driver's door	All the doors	O	–	O

■ Wireless remote control (→P. 102)

Function	Default setting	Customized setting	①	②	③
Wireless remote control	On	Off	–	–	O
Unlocking operation	Driver's door unlocked in one step, all doors unlocked in two steps	All doors unlocked in one step	O	–	O
Alarm (panic mode)	On	Off	–	–	O

■ **Smart key system (→P. 120) and wireless remote control (→P. 102)**

Function	Default setting	Customized setting	①	②	③
Operation signal (Emergency flashers)	On	Off	O	—	O
Time elapsed before automatic door lock function is activated if door is not opened after being unlocked	60 seconds	Off	O	—	O
		30 seconds			
		120 seconds			
Operation signal (Buzzers)	5	Off	O	—	O
		1 to 7			
Open door warning function (when locking the vehicle)	On	Off	—	—	O

■ **Door lock (→P. 106)**

Function	Default setting	Customized setting	①	②	③
Unlocking using a mechanical key	Driver's door unlocked in one step, all doors unlocked in two steps	All doors unlocked in one step	—	—	O
Automatic door lock	Shifting the shift lever to position other than P	Off	O	—	O
		Vehicle speed is approximately 12 mph (20 km/h) or higher			
Automatic door unlock	Shifting the shift lever to P	Off	O	—	O
		Driver's door is opened			

■ Power windows (→P. 150)

Function	Default setting	Customized setting	①	②	③
Mechanical key linked operation (close)	Off	On	—	—	○
Mechanical key linked operation (open)	Off	On	—	—	○
Wireless remote control linked operation (open)	Off	On	—	—	○
Open door reminder buzzer	On	Off	—	—	○
Buzzer sounds if operated using wireless remote control	On	Off	—	—	○

■ Moon roof (→P. 154)

Function	Default setting	Customized setting	①	②	③
Mechanical key linked operation (open)*1	Off	On	—	—	○
Mechanical key linked operation (close)*1	Off	On	—	—	○
Linked operation of components when door key is used	Slide only	Tilt only	—	—	○
Wireless remote control linked operation (open)*2	Off	On	—	—	○
Linked operation of components when wireless remote control used	Slide only	Tilt only	—	—	○
Open moon roof reminder buzzer	On	Off	—	—	○

*1: The settings can be changed when the mechanical key linked operation of the power window is set to on.

*2: The settings can be changed when the wireless remote control linked operation of the power window is set to on.

■ Illumination (→P. 393)

Function	Default setting	Customized setting	①	②	③
Interior lights illumination control	On	Off	—	—	○
Time period before the interior lights turn off	15 seconds	Off	—	—	○
		7.5 seconds	○	—	○
		30 seconds	—	—	○
Operation after the engine switch is turned off	On	Off	—	—	○
Operation when the doors are unlocked	On	Off	—	—	○
Operation when you approach the vehicle with the electronic key on your person (When the interior light switch is door position)	On	Off	—	—	○
Shift lever light	On	Off	—	—	○
Footwell lights	On	Off	—	—	○
Ambient lights and footwell lights illumination control	On	Off	—	—	○
Ambient lights	On	Off	—	—	○
Sensitivity of the ambient light sensor used for dimming the meter lights etc.	Standard	-2 to 2	—	—	○
Sensitivity of the ambient light sensor used for brightening the meter lights etc.	Standard	-2 to 2	—	—	○

■ Automatic light control system (→P. 205)

Function	Default setting	Customized setting	①	②	③
Light sensor sensitivity	Standard	-2 to 2	<input type="radio"/>	<input type="radio"/>	<input type="radio"/>
Daytime running light system	On	Off	<input type="radio"/>	<input type="radio"/>	<input type="radio"/>
Time elapsed before headlights automatically turn off after doors are closed	30 seconds	Off	<input type="radio"/>	<input type="radio"/>	<input type="radio"/>
		60 seconds			
		90 seconds			
Welcome lighting illumination control	On	Off	<input type="radio"/>	<input type="radio"/>	<input type="radio"/>

■ Intuitive parking assist (→P. 272)

Function	Default setting	Customized setting	①	②	③
Detection distance of the rear center sensor	Far	Near	<input type="radio"/>	<input type="radio"/>	<input type="radio"/>
Alert Volume (alert volume can be adjusted)	3	1 to 5	<input type="radio"/>	<input type="radio"/>	<input type="radio"/>
Display setting (when intuitive parking assist is operating)	All sensors displayed	Display off	<input type="radio"/>	<input type="radio"/>	<input type="radio"/>

■ Automatic air conditioning system (→P. 374)

Function	Default setting	Customized setting	①	②	③
A/C Auto switch operation	Auto	Manual	<input type="radio"/>	<input type="radio"/>	<input type="radio"/>

■ **Outside rear view mirrors (→P. 147)**

Function	Default setting	Customized setting	①	②	③
Automatic folding/ extending operation	Linked to locking/unlocking of the doors	Off			
		Linked to engine switch operation	—	—	○
Linked mirror function when reversing	On	Off	—	—	○



■ **Front seat heaters and ventilators (→P. 390)**

Function	Default setting	Customized setting	①	②	③
Adjustment of the front seat heater temperature or the ventilator fan speed during automatic operation (individual seat adjustment available)	Level 3 (standard)	Level 1 (low) to level 5 (high)	—	—	○

■ **Driving position memory (→P. 136)**

Function	Default setting	Customized setting	①	②	③
Selection the door linking driving position memory with door unlock operation	Driver's door	All doors	—	—	○

■ Multi-information display (→P. 89)

Function	Default setting	Customized setting	①	②	③
Language*1	English	French	○	○	—
		Spanish	○	○	—
Units*1	miles (MPG US)	miles (MPG Imperial)	○	○	—
		km (L/100 km)	○	○	—
		km (km/L)	○	○	—
Eco Driving Indicator Light	On	Off	—	○	—
 switch settings	Drive information 1	Desired status screen*2	—	○	—
Drive information screen displayed on the first screen of  (Drive information 1)	Current fuel consumption	*3	—	○	—
	Average fuel economy (after reset)				
Drive information screen displayed on the second screen of  (Drive information 2)	Distance (range)	*3	—	○	—
	Average speed (after reset)				
Pop-up display	On	Off	—	○	—
Accent color	Color 1	Color 1 to color 4	○	○	—

*1: The default setting varies according to countries.

*2: Some status screens cannot be registered (indicated on the multi-information display)

*3: 2 of the following items: current fuel consumption, average fuel economy (after reset), average fuel economy (after refuel), average fuel economy (after start), average vehicle speed (after reset), average vehicle speed (after start), distance (driving range), distance (after start), elapsed time (after reset), elapsed time (after start), blank

■ **LDA (Lane Departure Alert with steering control)* (→P. 248)**

Function	Default setting	Customized setting	①	②	③
Alert sensitivity	Standard	High	—	○	—
Vehicle sway warning	On	Off	—	○	—
Vehicle sway warning sensitivity	Standard	Low	—	○	—
		High			

*: If equipped

■ **BSM (Blind Spot Monitor)* (→P. 343)**

Function	Default setting	Customized setting	①	②	③
BSM (Blind Spot Monitor)	On	Off	—	○	—
RCTA (Rear Cross Traffic Alert function)	On	Off	—	○	—
Outside rear view mirror indicator brightness	Bright	Dim	—	—	○
Alert timing for presence of approaching vehicle (BSM function only)	Intermediate	Early	—	—	○
		Late			
		Only when in blind spot			
RCTA buzzer volume	Level 2	Level 1	—	—	○
		Level 3			

*: If equipped

■ Vehicle customization

- If the smart key system is turned off, unlock door cannot be selected.
- If the doors are not opened after unlocking and are then automatically re-locked, a signal will be given if “Operation signal (Emergency flashers)” or “Operation signal (Buzzer)” are set to on.

■ When setting using the multi-information display (vehicles with navigation system)

When using the multi-information display to set an item that can also be set using the navigation system, the item displayed on the navigation system will not change immediately.

If the engine switch is first turned off, the screen display will change once the engine switch is turned to IGNITION ON mode again.

■ When customizing using the navigation system

Stop the vehicle in a safe place, apply the parking brake, and shift the shift lever to P. Also, to prevent battery discharge, leave the engine running while customizing the features.



WARNING

■ During customization

As the engine needs to be running during customization, ensure that the vehicle is parked in a place with adequate ventilation. In a closed area such as a garage, exhaust gases including harmful carbon monoxide (CO) may collect and enter the vehicle. This may lead to death or a serious health hazard.



NOTICE

■ During customization

To prevent battery discharge, ensure that the engine is running while customizing features.

Items to initialize

The following item must be initialized for normal system operation after such cases as the battery being reconnected, or maintenance being performed on the vehicle:

Item	When to initialize	Reference
Message indicating maintenance is required	After the maintenance is performed	P. 441
Tire pressure warning system	<ul style="list-style-type: none"> • When rotating the tires on vehicles differing with front and rear tire inflation pressures. • When changing the tire inflation pressure by changing traveling speed or load weight, etc. • When changing the tire size. 	P. 464
Multi-terrain Monitor*	After reconnecting or changing the battery	P. 293
Engine oil maintenance data*	After the maintenance is performed	P. 452

*: If equipped

For U.S. owners

9

585

Reporting safety defects
for U.S. owners..... 586

Reporting safety defects for U.S. owners

If you believe that your vehicle has a defect which could cause a crash or could cause injury or death, you should immediately inform the National Highway Traffic Safety Administration (NHTSA) in addition to notifying Toyota Motor Sales, U.S.A., Inc. (Toll-free: 1-800-331-4331).

If NHTSA receives similar complaints, it may open an investigation, and if it finds that a safety defect exists in a group of vehicles, it may order a recall and remedy campaign. However, NHTSA cannot become involved in individual problems between you, your dealer, or Toyota Motor Sales, U.S.A., Inc.

To contact NHTSA, you may call the Vehicle Safety Hotline toll-free at 1-888-327-4236 (TTY: 1-800-424-9153); go to <http://www.safercar.gov>; or write to: Administrator, NHTSA, 1200 New Jersey Ave, S.E., Washington, DC 20590. You can also obtain other information about motor vehicle safety from <http://www.safercar.gov>.

Index

587

What to do if... (Troubleshooting)	588
Alphabetical index	592

For vehicles with a navigation system or a multimedia system, refer to the “NAVIGATION SYSTEM OWNER’S MANUAL” for information regarding the equipment listed below.

- Navigation system
- Audio/video system
- Rear seat entertainment system
- Hands-free system (for cellular phone)

What to do if... (Troubleshooting)

If you have a problem, check the following before contacting your Toyota dealer.

The doors cannot be locked, unlocked, opened or closed



You lose your keys

- If you lose your mechanical keys, new genuine mechanical keys can be made by your Toyota dealer. (→P. 103)
- If you lose your electronic keys, the risk of vehicle theft increases significantly. Contact your Toyota dealer immediately. (→P. 105)



The doors cannot be locked or unlocked

- Is the electronic key battery weak or depleted? (→P. 479)
- Is the engine switch in IGNITION ON mode?
When locking the doors, turn the engine switch off. (→P. 194)
- Is the electronic key left inside the vehicle?
When locking the doors, make sure that you have the electronic key on your person.
- The function may not operate properly due to the condition of the radio wave. (→P. 122)



The rear door cannot be opened

- Is the child-protector lock set?
The rear door cannot be opened from inside the vehicle when the lock is set. Open the rear door from outside and then unlock the child-protector lock. (→P. 109)

If you think something is wrong**The engine does not start**

- Did you press the engine switch while firmly depressing the brake pedal? (→P. 193)
- Is the shift lever in P? (→P. 195)
- Is the electronic key anywhere detectable inside the vehicle? (→P. 121)
- Is the steering wheel unlocked? (→P. 196)
- Is the electronic key battery weak or depleted?
In this case, the engine can be started in a temporary way. (→P. 541)
- Is the battery discharged? (→P. 543)

**The shift lever cannot be shifted from P even if you depress the brake pedal**

- Is the engine switch in IGNITION ON mode?
If you cannot release the shift lever by depressing the brake pedal with the engine switch in IGNITION ON mode (→P. 539)

**The steering wheel cannot be turned after the engine is stopped**

- It is locked automatically to prevent theft of the vehicle. (→P. 196)

**The windows do not open or close by operating the power window switches**

- Is the window lock switch pressed?
The power window except for the one at the driver's seat cannot be operated if the window lock switch is pressed. (→P. 150)



The engine switch is turned off automatically

- The auto power off function will be operated if the vehicle is left in ACCESSORY or IGNITION ON mode (the engine is not running) for a period of time. (→P. 195)



A warning buzzer sounds during driving

- The seat belt reminder light is flashing
Are the driver and the front passenger wearing the seat belts?
(→P. 512)
- The parking brake indicator is on
Is the parking brake released? (→P. 204)

Depending on the situation, other types of warning buzzer may also sound.
(→P. 510, 519)



An alarm is activated and the horn sounds

- Did anyone inside the vehicle open a door during setting the alarm?
The sensor detects it and the alarm sounds. (→P. 76)

To stop the alarm, turn the engine switch to IGNITION ON mode or start the engine.

**A warning buzzer sounds when leaving the vehicle**

- Is the electronic key left inside the vehicle or the moon roof opened?
Check the message on the multi-information display. (→P. 519)

**A warning light turns on or a warning message is displayed**

- When a warning light turns on or a warning message is displayed, refer to P. 510, 519.

When a problem has occurred**If you have a flat tire**

- Stop the vehicle in a safe place and replace the flat tire with the spare tire. (→P. 524)

**The vehicle becomes stuck**

- Try the procedure for when the vehicle becomes stuck in mud, dirt, or snow. (→P. 549)

Alphabetical index

A

A/C	374, 385
Air conditioning filter	477
Changing the rear seat settings	378
Front automatic air conditioning system	374
Micro dust and pollen filter	380
Rear air conditioning system	385
ABS (Anti-lock Brake System)	357
Function	357
Warning light	511
Active head restraint	127
Active TRAC	357
Air cleaner	448
Air conditioning filter	477
Air conditioning system	374, 385
Air conditioning filter	477
Changing the rear seat settings	378
Front automatic air conditioning system	374
Micro dust and pollen filter	380
Rear air conditioning system	385

Airbags	38
Airbag operating conditions	46
Airbag precautions for your child	41
Airbag warning light	510
Correct driving posture	28
Curtain shield airbag operating conditions	46
Curtain shield airbag precautions	44
Front passenger occupant classification system	51
General airbag precautions	41
Locations of airbags	38
Modification and disposal of airbags	45
“RSCA OFF” switch	50
Side airbag operating conditions	46
Side airbag precautions	43
Side and curtain shield airbags operating conditions	46
Side and curtain shield airbags precautions	44
SRS airbags	38
Alarm	76
Alarm	76
Warning buzzer	510
Anchor brackets	63
Antenna	
Smart key system	120

Anti-lock brake system
(ABS) 357
 Function 357
 Warning light 511
Approach warning
 Dynamic radar cruise
 control 264
Armrest 420
Assist grips 421
Audio input*
Audio system*
Automatic air conditioning
system
 Air conditioning filter 477
 Automatic air conditioning
 system 374
Automatic door locking and
unlocking systems 110
Automatic headlight leveling
system 207
 Function 207
Automatic High Beam 209
Automatic light control
system 207

Automatic transmission 199
 2nd start switch 200
 Downshift restriction
 warning buzzer 202
 If the shift lever cannot be
 shifted from P 539
 S mode 201
AUX port*
Auxiliary boxes 403

B

Back door 114
 Back door handle 115
 Wireless remote control 106
Back-up lights
 Replacing light bulbs 492
 Wattage 559
Battery 459
 Battery checking 459
 If the vehicle battery
 is discharged 543
 Preparing and checking
 before winter 369
 Voltmeter 85
 Warning light 510
Blind Spot Monitor (BSM) 343
Bluetooth®*

*: Refer to the "NAVIGATION SYSTEM OWNER'S MANUAL".

Bluetooth® audio*
Bluetooth® phone*
Bottle holders 402
Brake
 Fluid 558
 Parking brake 204
 Warning light 510
Brake assist 357
Break-in tips 161
Brightness control
 Instrument panel light
 control 86
BSM (Blind Spot Monitor) 343
 Blind Spot Monitor
 function 347
 Rear Cross Traffic Alert
 function 351

C

Care 434, 437
 Aluminum wheels 434
 Exterior 434
 Interior 437
 Radar sensor 346
 Seat belts 438

Cargo capacity 175
Cargo hooks 404
CD player*
Chains 370
Child restraint system 58
 Booster seat definition 59
 Booster seat installation 68
 Convertible definition 59
 Convertible installation 66
 Front passenger occupant
 classification system 51
 Infant seat/convertible seat
 definition 59
 Infant seat/convertible seat
 installation 65
 Installing CRS with LATCH
 system 64
 Installing CRS with seat belt... 65
 Installing CRS with top
 tether strap 69
 LATCH system 64

Child safety 57
 Airbag precautions 41
 Back door precautions 117
 Battery precautions 460, 545
 Child-protectors 109
 Child restraint system 58
 How your child should
 wear the seat belt 34
 Installing child restraints 63
 Moon roof precautions 157
 Power window lock switch 150
 Power window
 precautions 153
 Rear door child-protectors 109
 Removed key battery
 precautions 480
 Safety information 57
 Seat belt extender
 precautions 37
 Seat belt precautions 36
 Seat heater precautions 389
Child-protectors 109
Cleaning 434, 437
 Aluminum wheels 434
 Exterior 434
 Interior 437
 Radar sensor 346
 Seat belts 438
Clock 409
Coat hooks 420
Compass 89
Condenser 456
Console box 398
Coolant
 Capacity 556
 Checking 455
 Preparing and checking
 before winter 369
Cool box 406
Cooling system 455
 Engine overheating 546

Crawl Control 284
Cruise control
 Cruise control 269
 Dynamic radar cruise
 control 257
Cup holders 400
Curtain shield airbags 38
Customizable features 574

D

**Daytime running light
 system 207**
Defogger
 Outside rear view
 mirrors 380
 Rear window 380
 Windshield 379
Differential 557
Dimension 552
Dinghy towing 192
Display
 Drive information 92
 Dynamic radar cruise
 control 257
 Fuel consumption
 information 98
 Intuitive parking assist 273
 LDA (Lane Departure
 Alert) 252
 Multi-information display 89
 Warning messages 519

*: Refer to the "NAVIGATION SYSTEM OWNER'S MANUAL".

Do-it-yourself maintenance	447
Door courtesy lights	
Location	393
Doors	
Automatic door locking and unlocking system.....	110
Back door.....	114
Door glasses.....	150
Door lock.....	106
Open door warning buzzer ...	512
Open door warning light.....	512
Outside rear view mirrors.....	147
Rear door child-protectors	109
Side doors.....	106
Drive information	92
Driver's seat belt reminder light.....	512
Driver's seat position memory	136
Driving	160
Break-in tips.....	161
Correct posture	28
Driving in the rain.....	161
Off-road precautions	364
Procedures	160
Winter drive tips	369
Driving position memory	136
Driving position memory	136
Memory recall function.....	137
Dynamic radar cruise control.....	257
Function	257

E

Eco Driving Indicator	96
EDR (Event data recorder).....	10
Electronic key	102
Battery-saving function	122
If the electronic key does not operate properly	540
Replacing the battery.....	479
Emergency, in case of	
If a warning buzzer sounds.....	510
If a warning light turns on	510
If a warning message is displayed	519
If the electronic key does not operate properly	540
If the engine will not start.....	537
If the shift lever cannot be shifted from P	539
If the vehicle has discharged battery.....	543
If you have a flat tire	524
If you lose your keys.....	103, 105
If you think something is wrong	508
If your vehicle becomes stuck.....	549
If your vehicle has to be stopped in an emergency	501
If your vehicle needs to be towed.....	502
If your vehicle overheats.....	546

Emergency flashers 500

Engine

- Accessory mode 194
- Air cleaner..... 448
- Compartment 450
- Engine switch..... 193
- Exhaust gas precautions 73
- Hood 449
- How to start the engine 193
- Identification number 553
- If the engine will not start 537
- If your vehicle has to be
stopped in an
emergency..... 501
- Ignition switch
(engine switch) 193
- Overheating 546

Engine compartment cover 451

Engine coolant..... 455

- Capacity 556
- Checking..... 455
- Preparing and checking
before winter..... 369

**Engine coolant temperature
gauge..... 85**

Engine immobilizer system 74

Engine oil 452

- Capacity..... 554
- Checking..... 452
- Preparing and checking
before winter..... 369

**Engine switch
(ignition switch)..... 193**

**Engine switch light
(ignition switch light)..... 393**

Event data recorder (EDR)..... 10

Exhaust gas precautions 73

F

First-aid kit holder 405

Flat tire 524

Floor mats 26

Fluid

- Automatic transmission 557
- Brake 558
- Steering 558
- Washer 462

Fog lights 214

- Replacing light bulbs 497
- Switch 214

Four-wheel drive system

- Center differential
lock/unlock 281
- Four-wheel drive control
switch 280
- Warning light..... 514

**Front automatic air
conditioning system 374**

Front doors 106

Front passenger occupant classification system	51
Front passenger's seat belt reminder light	512
Front seats	127
Adjustment	127
Cleaning.....	437
Correct driving posture	28
Driving position memory	136
Head restraints	140
Seat heaters	390
Seat position memory	136
Seat ventilators	390
Front side marker lights	205
Light switch	205
Replacing light bulbs.....	489
Wattage	559
Front turn signal lights	
Replacing light bulbs.....	490
Turn signal lever	203
Wattage	559
Fuel	
Capacity.....	554
Fuel gauge.....	85
Fuel pump shut off system	509
Gas station information.....	608
Information.....	560
Refueling.....	222
Type.....	554
Warning light.....	512

Fuel consumption information	98
Fuel filler door	222
Opener.....	224
Refueling	222
Fuel pump shut off system	509
Fuses	481

G

Gas station information	608
Garage door opener	422
Gauges	85
Glove box	397

H

Hands-free system (for cellular phone)*	
Head restraints	140
Headlight cleaner	221
Headlights	205
Automatic headlight leveling.....	207
Automatic High Beam system.....	209
Headlight aim.....	485
Light switch.....	205
Replacing light bulbs	497
Heated steering wheel	389

Heaters

- Front automatic air conditioning system..... 374
- Outside rear view mirrors..... 380
- Seat heaters 390

High mounted stoplight

- Replacing..... 497

Hill-start assist control..... 357

Hood 449

Hooks

- Cargo hooks 404
- Coat hooks..... 420
- Retaining hooks (floor mat)..... 26

Horn 143

I

I/M test 446

Identification

- Engine..... 553
- Vehicle 553

Ignition switch

- (engine switch)..... 193

Ignition switch light

- (engine switch light) 393

Illuminated entry system 395

Immobilizer system 74

Indicators 80

Initialization

- Items to initialize 584
- Maintenance 441
- Power windows..... 152
- Tire pressure warning system..... 465

Inside door handle light 393

Inside rear view mirror 145

Instrument panel light

- control..... 86

Interior lights 393

- Switch 394

Intuitive parking assist 272

J

Jack

- Vehicle-equipped jack..... 525

Jack handle..... 525

Jam protection function

- Moon roof 155
- Power windows..... 151

*: Refer to the "NAVIGATION SYSTEM OWNER'S MANUAL".

K

- KDSS (Kinetic Dynamic Suspension System)..... 357**
- Keyless entry**
 - Smart key system 120
 - Wireless remote control 102
- Keys 102**
 - Battery-saving function 122
 - Electronic key 102
 - Engine switch..... 193
 - If the electronic key does not operate properly 540
 - If you lose your keys 103, 105
 - Key number plate..... 102
 - Keyless entry 102
 - Keys..... 102
 - Mechanical key 102
 - Replacing the battery..... 479
 - Warning buzzer..... 121
- Kinetic dynamic suspension system (KDSS) 357**
- Knee airbags 38**

L

- Language (multi-information display)..... 581**
- LATCH system 64**
- LDA (Lane Departure Alert) 248**
- Lever**
 - Auxiliary catch lever..... 449
 - Hood lock release lever 449
 - Shift lever 199
 - Turn signal lever 203
 - Wiper lever..... 215
- License plate lights**
 - Light switch 205
 - Replacing light bulbs..... 496
 - Wattage 559

Light

- Automatic High Beam system..... 209
- Door courtesy lights..... 393
- Engine switch light (ignition switch light)..... 393
- Fog light switch..... 214
- Headlight switch 205
- Illuminated entry system..... 395
- Inside door handle lights..... 393
- Interior lights 394
- Personal lights 395
- Replacing light bulbs 487
- Turn signal lever 203
- Vanity lights 408
- Wattage 559
- Light bulbs**
 - Replacing..... 487
 - Wattage 559
- Lock steering column 196**

M**Maintenance**

- Do-it-yourself maintenance..... 447
- General maintenance 443
- Maintenance data 552
- Maintenance requirements 440
- Scheduled maintenance 440
- Malfunction indicator lamp..... 510**

Meter 85
 Indicators 80
 Instrument panel light
 control..... 86
 Meters..... 85
 Multi-information display 89
 Warning lights 510
 Warning messages 519
Micro dust and pollen filter..... 380
Mirrors
 Inside rear view mirror 145
 Outside rear view mirror
 defoggers 380
 Outside rear view mirrors..... 147
 Vanity mirrors..... 408
Moon roof 154
 Jam protection function..... 155
 Operation 154
MP3 disc*
Multi-information display 89
 Display contents 89
 Drive information..... 92
 Dynamic radar cruise
 control..... 257
 Language..... 581
 LDA (Lane Departure
 Alert)..... 252
 Switching the display 91
 Warning messages 519
Multi-terrain ABS 357
Multi-terrain Monitor..... 293
Multi-terrain Select 289

N

Navigation system*
Noise from under vehicle 8

O

Odometer 85
Off road precautions 364
Oil
 Engine oil..... 554
 Front differential oil 557
 Rear differential oil..... 557
 Transfer oil..... 557
Opener
 Back door 115
 Fuel filler door 224
 Hood 449
Outside rear view mirrors..... 147
 Adjusting and folding 147
 Blind Spot Monitor 343
 Driving position memory 136
 Linked mirror function when
 reversing 148
 Mirror position memory 136
 Outside rear view mirror
 defoggers 380
**Outside temperature
 display..... 409**
Overheating, Engine 546

*: Refer to the "NAVIGATION SYSTEM OWNER'S MANUAL".

P

Panic mode	103
Parking assist sensors (intuitive parking assist)	272
Parking brake	204
Operation	204
Parking brake engaged warning buzzer	204
Parking lights	205
Light switch	205
Replacing light bulbs.....	497
PCS (Pre-Collision system)	233
Enabling/disabling the system	237
Function	233
Warning light.....	511
Personal lights	393
Switch	395
Power outlets	410
Power steering	
Fluid	558
Power windows	150
Jam protection function.....	151
Operation	150
Window lock switch.....	150
Pre-Collision system (PCS)	233
Enabling/disabling the system	237
Function	233
Warning light.....	511

R

Radar cruise control (dynamic radar cruise control)	257
Radiator	456
Radio*	
Rear air conditioning system	385
Rear seat	129
Adjustment.....	129
Folding up the third seats.....	132
Tumbling the second seats.....	130
Rear side marker lights	205
Light switch.....	205
Replacing light bulbs	497
Rear step bumper	116
Rear turn signal lights	203
Replacing light bulbs	494
Turn signal lever	203
Wattage	559
Rear view mirror	
Inside rear view mirror	145
Outside rear view mirrors	147
Rear view monitor system*	
Rear window defogger	380
Rear window wiper	219
Refueling	222
Capacity.....	554
Fuel types	554
Opening the fuel tank cap....	222
Replacing	
Electronic key battery	479
Fuses.....	481
Light bulbs	487
Tires.....	524
Reporting safety defects for U.S. owners	586
Resetting the message indicating maintenance is required	441
Roof luggage carrier	169

S

Safety Connect 427
Scheduled maintenance 440
Seat belts..... 30
 Adjusting the seat belt 33
 Automatic Locking
 Retractor..... 34
 Child restraint system
 installation 63
 Cleaning and maintaining
 the seat belt..... 438
 Emergency Locking
 Retractor..... 34
 How to wear your seat belt 30
 How your child should
 wear the seat belt..... 34
 Pregnant women, proper
 seat belt use 35
 Reminder light and
 buzzer..... 512
 Seat belt extender..... 34
 Seat belt pretensioners..... 33
 SRS warning light 510
Seat heaters 390
Seat position memory 136
Seat ventilators..... 390
Seating capacity 175

Seats..... 127, 129
 Adjustment..... 127, 129
 Adjustment
 precautions..... 128, 135
 Armrest..... 420
 Child seats/child restraint
 system installation..... 63
 Cleaning 437
 Driving position memory 136
 Folding up the third
 seats..... 132
 Front seats..... 127
 Head restraint 140
 Heaters 389
 Properly sitting in the seat 28
 Seat heaters 389
 Seat position memory..... 136
 Seat ventilators..... 389
 Second seats..... 129
 Third seats..... 129
 Tumbling the second
 seats..... 130
 Ventilators..... 389
Sensor
 Automatic headlight
 system..... 207
 Automatic High Beam
 system..... 230
 Inside rear view mirror 146
 Intuitive parking assist 272
 LDA (Lane Departure
 Alert)..... 248
 Radar sensor 228
 Rain-sensing windshield
 wipers..... 217
Service reminder indicators 80

*: Refer to the "NAVIGATION SYSTEM OWNER'S MANUAL".

Shift lever	
Automatic transmission.....	199
If the shift lever cannot be shifted from P	539
Shift lock system	539
Side airbags	38
Side doors	106
Side marker lights	205
Light switch	205
Replacing light bulbs.....	489, 497
Wattage	559
Side mirrors	147
Adjusting and folding	147
Blind Spot Monitor	343
Heaters	380
Mirror position memory	136
Smart key system	120
Antenna location	120
Entry functions	106, 114
Starting the engine.....	193
Snow tires	369
“SOS” button	427
Spare tire	
Inflation pressure	558
Storage location.....	525
Spark plug	556
Specifications	552
Speedometer	85
SRS airbags	38
Steering	
Column lock release	196
Fluid	558
Steering wheel	143
Adjustment.....	143
Audio switches *	
Heated steering wheel	389
Meter control switches	91
Telephone switches *	
Stop/tail lights	
Replacing light bulbs	497
Storage feature	396
Stuck	
If the vehicle becomes stuck.....	549
Sun visors	408
Sunshade	
Roof	155
Switch	
Audio remote control switches *	
Automatic High Beam switch	209
Center differential lock/unlock switch	281
Clock adjustment buttons	409
Cruise control switch	269, 257
Door lock switch	108
Driving position memory switches	136
Emergency flashers switch	500
Engine switch	193
Fog light switch.....	214
Four-wheel drive control switch	280
Garage door opener switches	422
Headlight cleaner switch.....	221
Heated steering wheel.....	389
Interior light switch.....	394
Intuitive parking assist	272
Ignition switch	193
LDA (Lane Departure Alert).....	251
Light switches	205

Meter control switches 91
 Moon roof switches 154
 Outside rear view mirror
 switches 147
 Personal light switch 395
 Power door lock switch 108
 Power window switch 150
 Rear window wiper and
 washer switch 219
 Rear window and outside
 rear view mirror
 defoggers switch 380
 Seat heater switches 390
 Seat ventilator switches 390
 "SOS" button 427
 Talk switch*
 Telephone switches*
 Tilt and telescopic steering
 control switch 143
 Tire pressure warning
 reset switch 465
 Vehicle-to-vehicle distance
 button 263
 VSC OFF switch 359
 Window lock switch 150
 Windshield wipers and
 washer switch 215
 Wireless charger power
 supply switch 412

T

Tachometer 85
Tail lights 205
 Light switch 205
 Replacing light bulbs 497
Talk switch*
Telephone switches*
Theft deterrent system
 Alarm 76
 Immobilizer system 74
Tire inflation pressure 472
 Maintenance data 558
 Warning light 512
Tire information 563
 Glossary 569
 Size 565
 Tire identification number 564
 Uniform Tire Quality
 Grading 567
**Tire pressure warning
 system 464**
 Function 464
 Initializing 464
 Installing tire pressure
 warning valves and
 transmitters 464
 Registering ID codes 465
 Tire pressure warning
 reset switch 465
 Warning light 512

*: Refer to the "NAVIGATION SYSTEM OWNER'S MANUAL".

Tires 463
 Chains..... 370
 Checking..... 463
 If you have a flat tire 524
 Inflation pressure 472
 Information..... 563
 Replacing..... 524
 Rotating tires..... 463
 Size..... 558
 Snow tires 369
 Spare tire 524
 Tire pressure warning
 system..... 464
 Warning light..... 512
Tools 525
Top tether strap 63
Total load capacity 552
Towing
 Dinghy towing 192
 Emergency towing 502
 Towing eyelet..... 504
 Trailer Sway Control 358
 Trailer towing 176
Toyota Safety Sense P 226
TRAC (Traction Control) 357
Trailer Sway Control..... 358
Trailer towing 176
Transmission
 Automatic transmission..... 199
 Downshift restriction warning
 buzzer..... 202
 If the shift lever cannot be
 shifted from P 539
 Selecting a driving mode 200
 S mode 201
Trip information 98
Trip meters 85
Troubleshooting 588

Turn signal lights 203
 Replacing light
 bulbs..... 490, 494, 497
 Turn signal lever 203
 Wattage 559

U

USB port* 364
Utility vehicle precautions..... 364

V

Vanity lights 408
 Vanity lights 408
 Wattage 559
Vanity mirrors 408
Vehicle data recordings..... 9
Vehicle identification
 number 553
Vehicle Stability Control
 (VSC) 357
Ventilators
 (seat ventilators) 390
VSC (Vehicle Stability
 Control) 357

W

Warning buzzers..... 510
 Approach warning..... 264
 Brake system..... 510
 Downshifting 202
 Driver's seat belt
 reminder 512
 Intuitive parking assist 275
 Lane departure 253
 Master warning system..... 512
 Open back door 512
 Open door..... 512
 Parking brake..... 204
 PCS 511
 Radar cruise control..... 264
 Seat belt reminder 512
Warning lights..... 510
 ABS..... 511
 Brake system 510
 Center differential lock 514
 Charging system..... 510
 Low fuel level 512
 Low speed four-wheel
 drive..... 514
 Malfunction indicator lamp 510
 Master warning light..... 512
 Open door..... 512
 Pre-collision system..... 511
 Seat belt reminder light..... 512
 Slip indicator 511
 SRS 510
 Tire pressure..... 512

Warning messages..... 519
Warning reflector holder..... 404
Washer 215, 219
 Checking..... 462
 Preparing and checking
 before winter 369
 Switch 215, 219
Washing and waxing..... 434
Weights
 Cargo capacity..... 175
 Load limits 175
 Weights..... 552
**What to do if...
 (Troubleshooting) 588**
Wheels..... 475
 Replacing wheels 524
 Size..... 558
Window glasses 150
Window lock switch 150
Windows
 Power windows..... 150
 Rear window defogger..... 380
 Washer 215, 219
Windshield wiper de-icer 380
Windshield wipers..... 215
 Intermittent windshield
 wipers..... 215
 Rain-sensing windshield
 wipers..... 216
Winter driving tips..... 369
Wireless charger 412
**Wireless remote control
 key..... 102**
 Battery-saving function 122
 Locking/Unlocking 102
 Panic mode..... 103
 Replacing the battery..... 479
WMA disc*

*: Refer to the "NAVIGATION SYSTEM OWNER'S MANUAL".

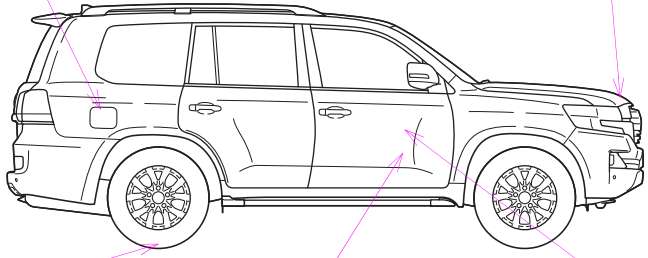
GAS STATION INFORMATION																						
Fuel filler door P. 224	Auxiliary catch lever P. 449																					
																						
Tire inflation pressure P. 558	Fuel filler door opener P. 224																					
<small>INPLA045</small>																						
<table border="1" style="width: 100%; border-collapse: collapse;"> <tr> <td style="padding: 5px;">Fuel tank capacity (Reference)</td> <td colspan="2" style="padding: 5px;">24.5 gal. (93 L, 20.4 Imp.gal)</td> </tr> <tr> <td style="padding: 5px;">Fuel type</td> <td style="padding: 5px;">Unleaded gasoline only</td> <td style="text-align: right; padding: 5px;">P. 554</td> </tr> <tr> <td style="padding: 5px;">Cold tire inflation pressure</td> <td colspan="2" style="text-align: right; padding: 5px;">P. 558</td> </tr> <tr> <td style="padding: 5px;">Engine oil capacity (Drain and refill — reference)</td> <td style="padding: 5px;">With filter</td> <td style="padding: 5px;">7.9 qt. (7.5 L, 6.6 Imp.qt.)</td> </tr> <tr> <td></td> <td style="padding: 5px;">Without filter</td> <td style="padding: 5px;">7.5 qt. (7.1 L, 6.2 Imp.qt.)</td> </tr> <tr> <td style="padding: 5px;">Engine oil type</td> <td colspan="2" style="padding: 5px;">"Toyota Genuine Motor Oil" or equivalent</td> </tr> <tr> <td></td> <td colspan="2" style="text-align: right; padding: 5px;">P. 554</td> </tr> </table>		Fuel tank capacity (Reference)	24.5 gal. (93 L, 20.4 Imp.gal)		Fuel type	Unleaded gasoline only	P. 554	Cold tire inflation pressure	P. 558		Engine oil capacity (Drain and refill — reference)	With filter	7.9 qt. (7.5 L, 6.6 Imp.qt.)		Without filter	7.5 qt. (7.1 L, 6.2 Imp.qt.)	Engine oil type	"Toyota Genuine Motor Oil" or equivalent			P. 554	
Fuel tank capacity (Reference)	24.5 gal. (93 L, 20.4 Imp.gal)																					
Fuel type	Unleaded gasoline only	P. 554																				
Cold tire inflation pressure	P. 558																					
Engine oil capacity (Drain and refill — reference)	With filter	7.9 qt. (7.5 L, 6.6 Imp.qt.)																				
	Without filter	7.5 qt. (7.1 L, 6.2 Imp.qt.)																				
Engine oil type	"Toyota Genuine Motor Oil" or equivalent																					
	P. 554																					